



Gesamtkatalog
General Catalogue
Catálogo General
Catalogo Generale



AMNOTEC

Der Ihnen vorliegende Gesamtkatalog bleibt Eigentum der AMNOTEC International Medical GmbH. Dies gilt auch dann, wenn eine Leih- oder Schutzgebühr für diesen Katalog entrichtet wurde. Er darf ausschließlich zum Zweck des Einkaufs und Vertriebs der darin beschriebenen AMNOTEC-Produkte durch den hierzu autorisierten Fachhandel oder zur Bedarfsbeschaffung durch den entsprechenden Anwender benutzt werden. Die Verwendung des Katalogs entgegen unseren Interessen berechtigt uns zur unverzüglichen Rückforderung und optionalen weiteren Maßnahmen. Dieser Katalog darf weder teilweise noch im Gesamten kopiert, digital eingeleistet oder nachgedruckt werden, sofern nicht unsere ausdrückliche, schriftliche Genehmigung vorliegt.

The general catalogue remains the property of AMNOTEC International Medical GmbH. This also applies if a lending fee or nominal charge has been paid for this catalog. It may only be used for the purpose of purchasing and selling the AMNOTEC products described therein by the specialized trade authorized in this regard, or for supplying the needs of the respective user. The use of the catalog against our interests entitles us to demand that the catalog be returned immediately, as well as other possible actions. This catalog may not be copied in part or in whole, be digitally scanned or printed from a scan without our express, written consent.

El catálogo global de que tiene en su poder es propiedad de AMNOTEC International Medical GmbH. Esto también se aplica incluso en el caso de que haya pagado las tasas de préstamo o protección de dicho catálogo. Por lo tanto, sólo puede utilizarse para comprar y comercializar los productos de AMNOTEC que se describen en su interior a través de un establecimiento especializado autorizado, o bien para la adquisición por parte del usuario correspondiente de los productos que necesite. Si el catálogo se utiliza en contra de nuestros intereses, tendremos derecho a que éste se nos devuelva de inmediato, o bien a tomar las medidas que consideremos oportunas. Queda prohibida la reproducción total o parcial de este catálogo, así como su procesamiento digital o su reimpresión, sin nuestro consentimiento expreso y por escrito.

Il catalogo generale in vostro possesso rimane di proprietà di AMNOTEC International Medical GmbH. Ciò vale anche nel caso in cui per questo catalogo sia stato versato un contributo per prestito o spese. Il catalogo deve essere utilizzato esclusivamente per l'acquisto e la distribuzione dei prodotti AMNOTEC descritti nello stesso da parte del personale specializzato e autorizzato oppure per il necessario approvvigionamento da parte dei rispettivi utilizzatori. L'utilizzo del catalogo a scapito dei nostri interessi ci autorizza a richiederne l'immediata restituzione e a perseguire eventuali ulteriori misure. Questo catalogo non deve essere fotocopiato, riprodotto con mezzi digitali o ristampato, né parzialmente né integralmente, senza la nostra espressa autorizzazione scritta.

Modelländerungen vorbehalten
Patterns are subject to change
Tous droits réservés des changements de modèle
Ci riserviamo la facoltà di cambiamenti nei modelli

© AMNOTEC International Medical GmbH 2012. All rights reserved.



[Über uns](#)

[About us](#)

[Sobro nosotros](#)

[Il nostro profilo](#)



Tuttingen, Germany –
Weltzentrum der Medizintechnik
World centre of medical technology

AMNOTEK - Leidenschaft für Chirurgie Lösungen
AMNOTEK - Passion for Surgery Solutions

Der Begriff „Medizintechnik aus Tuttingen“ steht für hochwertigste chirurgische und medizintechnische Instrumente sowie für Dynamik und Fortschritt auf dem Gebiet der Implantattechnologie und der minimal-invasiven Chirurgie.

AMNOTEK sieht sich als innovatives Unternehmen des 21. Jahrhunderts eng mit diesem branchenprägenden Qualitätsbegriff verbunden.

Die Amnotec GmbH verfügt über mehr als 30 Jahre Erfahrung in der Medizintechnik. Dieses Fachwissen, die Qualität der Produkte sowie Flexibilität und ein exzellenter Kundenservice sind die Eckpfeiler unseres Unternehmens und machen uns zu einem kompetenten Partner und Komplett-Anbieter für den OP.

The concept „Medical technology from Tuttingen“ stands for surgical and medical-technology instruments of highest quality as well as for dynamic and progress in the field of the implant-technology and minimal invasive surgery.

As an innovative enterprise of the 21st century, AMNOTEK considers itself closely connected to this industry shaped quality concept.

The Amnotec GmbH has more than 25 years experience in the medical business. This specialized knowledge, the quality of the products as well as flexibility and an excellent customer service are the cornerstones of our company and make us to a competent partner and complete supplier for the OR.

Über 20.000 Artikel - weltweit verfügbar
More than 20.000 articles - in a worldwide distribution



Allgemein Chirurgie
General Surgery



Laparoskopie
Laparoscopy



Mikro Instrumente
Micro Instruments



Endoskope
Endoscopes



Dental Instrumente
Dental Instruments



Arthroskopie Instrumente
Arthroscopy Instruments



Container Systeme
Container Systems



Endoskopische Geräte
Endoscopic units



Hochfrequenz Chirurgie
High Frequency Surgery



Urologie
Urology



OP-Leuchten
Operating Lamps



Hysteroskopie
Hysteroscopy



OP-Tische
Operating Tables

Material
 Materials
 Material
 Materiale

Ausführung
 Specification
 Especificación
 Specifica



Titan | Titanium
 Titanio | Titanio



Aluminium | Aluminium
 Aluminio | Aluminio



Kunststoff | Plastic
 Plastico | Plastica



Keramikbeschichtung | Ceramic coating
 Superficie cerámica | Superficie alla ceramica



Silber | Silver
 Plata | Argento



Verchromt | Chrome plated
 Cromado | Cromato



Schwarz verchromt | Black Chrome plated
 Cromado negro | Cromato nero



Edelstahl | Stainless Steel
 Acero | Acciaio inossidabile



Neusilber | German silver
 Plata alemaña | Alpaca



Teflon® | Teflon®
 Teflon® | Teflon®



Nylon | Nylon
 Nilón | Nylon



Ferrozell | Ferrozell
 Ferrozell | Ferrozell



Propylux® | Propylux®
 Propylux® | Propylux®



Peek | Peek
 Peek | Peek



Supercut | Supercut
 Supercut | Supercut



Supercut Titan-Nitrit | Supercut Titanium-Nitrite
 Supercut Nitrito de Titanio | Nitrito di Titano



Hartmetalleinlagen | Tungsten Carbide inserts
 Carburo de tungsteno | Carburo di tungsteno



Diamantbeschichtet | Diamond dusted
 Recubrimiento de diamante | Rivestimento di diamante



Wellenschliff | Wave Cut
 Corte de la onda | Taglio dell'onda



1 Schneide gezahnt | 1 serrated blade
 1 hoja dentada | 1 lama dentata



2 Schneiden gezahnt | 2 serrated blades
 2 hojas dentadas | 2 lame dentate



Streamline Verschluss | Streamline box lock
 Cerradura de la caja | Serratura della scatola



mit Gegengewicht | with counterbalance
 con contrabalanza | con contrappeso

**Atraumatisch | Atraumatic
 Atraumáticas | Atraumatiche**



De Bakey, 1 Reihe | De Bakey, 1 serration
 De Bakey, 1 dentada | De Bakey, 1 dentata



De Bakey, 2 Reihen | De Bakey, 2 serrations
 De Bakey, 2 dentadas | De Bakey, 2 dentate



Cooley, 1 Reihe | Cooley, 1 serration
 Cooley, 1 dentada | Cooley, 1 dentata



Cooley, 2 Reihen | Cooley, 2 serrations
 Cooley, 2 dentadas | Cooley, 2 dentate

Artikel-Nummer
 Item number
 No del artículo
 Code articolo

Jede Zeichnung und/oder Produktabbildung in diesem Katalog hat nur eine Artikelnummer und wird auch nur einmal abgebildet.

Every drawing and/or image in this catalogue has its unique item number and is pictured just once.

Al lado del dibujo y/o la ilustración del producto. Cada producto tiene sólo un número y aparece solamente una vez en el catálogo.

Al lado del dibujo y/o la ilustración del producto. Cada producto tiene sólo un número y aparece solamente una vez en el catálogo.

Nummernschlüssel:

Number code:

Clave del número:

Chiave del codice:

12 - 201 - 14

12 - 201 - 14

12 - 201 - 14

12 - 201 - 14

Artikelgruppe

Product group

Grupo de artículos

Gruppo di articoli

Laufende Nr. innerhalb der Gruppe

Consecutive number within the group

Número corrido dentro del grupo

Numero progressivo all'interno del gruppo

Größe/Figur des Instruments

Size/shape of the instrument

Tamaño/forma del instrumento

Dimensioni/forma dello strumento



Arbeitsende des Produkts
 Working end of the product
 El extremo funcional del producto se muestra
 Risultato finale di lavorazione del prodotto

Optional: Ausführung
 Optional: Specification
 Opcional: Especificación
 Opzione: Specifica

12-201-18 W







Autor (wenn vorhanden)
 Author (if available)
 Autor (si ho lay)
 Autore (se disponibile)

METZENBAUM

12-201-18 18,0 cm, 7 " Maße
 Dimensions
 Dimensiones
 Dimensioni

Artikel-Nummer
 Item number
 No del artículo
 Codice articolo

Artikelgruppe Product group Grupo de artículos Gruppo di articoli		Kapitel Chapter Capítulo Capitolo	Seite Page Página Pagina
	Diagnostik Diagnostics Diagnóstico Diagnostica	10	15 - 90
	Scheren Scissors Tijeras Forbici	11	91 - 148
	SUPER CUT Scheren SUPER CUT scissors Tijeras SUPER CUT Forbici SUPER CUT	11 SC	149-158
	Scheren mit Hartmetallschneiden Scissors with tungsten carbide edges Tijeras con filos de carburo tungsteno Forbici con lame in carburo i tungsteno	12	159-182
	SUPER CUT TITAN-NITRIT Scheren SUPER CUT TITANIUM-NITRIT scissors Tijeras SUPER CUT NITRITO de TITANIO Forbici SUPER CUT NITRITO di TITANIO	12 SCT	183-192
	Pinzetten Forceps Pinzas Pinze	13	193-230
	Pinzetten mit Hartmetalleinlagen Forceps with tungsten carbide inserts Pinzas con bocas de carburo tungsteno Pinze con morsi in carburo di tungsteno	14	231-236
	Arterienklemmen Artery forceps, Haemostatic forceps Pinzas haemostaticas Pinze emostatiche	15	237-372

Artikelgruppe Product group Grupo de artículos Gruppo di articoli	Kapitel Chapter Capítulo Capitolo	Seite Page Página Pagina
 <p>Wundhaken Retractors Separadores Divaricatori</p>	16	373-486
 <p>Nadelhalter Needle holders Porta-agujas Portaghi</p>	17	487-518
 <p>Nadelhalter mit Hartmetalleinlagen Needle holders with tungsten carbide inserts Porta-agujas con bocas de carburo tungsteno Portaghi con morsi in carburo di tungsteno</p>	18	519-536
 <p>Neurochirurgie Neurosurgery Neurocirugía Neurochirurgia</p>	20	537-594
 <p>HNO-Instrumente ENT Instruments Instrumentos para ORL Strumenti per ORL</p>	26	595-708
 <p>HNO-Instrumente ENT Instruments Instrumentos para ORL Strumenti per ORL</p>	27	709-762
 <p>Thorax, Lunge Thorax, Lung Thorácio, Pulmòn Thorace, Polmone</p>	30	763-802
 <p>Herz- und Gefäßschirurgie Cardiovascular Surgery Cirugía cardiovascular Chirurgia cardiovascolare</p>	31	803-842

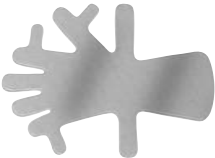
Artikelgruppe Product group Grupo de artículos Gruppo di articoli		Kapitel Chapter Capítulo Capitolo	Seite Page Página Pagina
	Magen, Darm, Rektum Stomach, Intestines, Rectum Estómago, Intestino, Recto Stomaco, Intestino, Retto	33	843-870
	Leber, Galle, Niere Liver, Gall bladder, Kidney Hígado, Bilis, Riñón Fegato, Biliari, Renali	34	871-878
	Gynäkologie, Geburtshilfe Gynaecology, Obstetrics Ginecologia, Obstetricia Ginecologia, Ostetricia	35	879-942
	Urologie Urology Urología Urologia	36	943-956
	Knochenchirurgie Bone Surgery Cirugía ósea Chirurgia ossea	40	957-1174
	Osteosynthese Osteosynthesis Osteosíntesis Osteosintesi	42-44	
	Hand- und Fuß Chirurgie Hand and foot Surgery Cirugía de mano y pie Chirurgia della mano e piede	47	1175-1184
	Gips- und Verbandinstrumente Plaster and Dressing Instruments Instrumentos para vendajes y yeso Strumenti per bendaggi e gessature	48	1185-1200

Artikelgruppe Product group Grupo de articulos Gruppo di articoli		Kapitel Chapter Capítulo Capitolo	Seite Page Página Pagina
	Arthroskopie Instrumente Arthroscopy Instruments Instrumentos para Artroscopia Strumenti per Artroscopia	49	
	Stationsinstrumente Ward Instruments Instrumentos para enfermería Strumenti per medicazione	50	1201-1210
	Behälter, GefäÙe Stainless Steel Holloware Recipientes Recipienti	51	1211-1218
	Container Systeme Container Systems Sistema de Contenedores Sistema di Contenitori	55	
	Sterilisation Sterilization Esterilización Sterilizzazione	56	1219-1228
	Motorensysteme Motor Systems Sistema de motor Sistema di motore	60	
	Arthroskopie Instrumente Arthroscopy Instruments Instrumentos para Artroscopia Strumenti per Artroscopia	65	
	Hochfrequenz Chirurgie High Frequency Surgery Cirugía de alta frecuencia Chirurgia ad alta frequenza	70	



10



Diagnostik

Diagnostics

Diagnóstico

Diagnostica



mit Nadel
with needle
con aguja
con ago

BUCK

10-000-18 18,0 cm, 7 "



DEJERINE

10-001-20 20,0 cm, 8 "



mit Nadel
with needle
con aguja
con ago

DEJERINE

10-002-21 20,0 cm, 8 "



TAYLOR

10-003-17 17,0 cm, 6 $\frac{3}{4}$ "
10-003-20 20,0 cm, 8 "

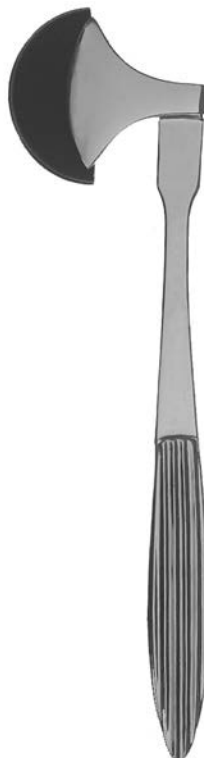

BERLINER

10-004-17 17,0 cm, 6 $\frac{3}{4}$ "
10-004-20 20,0 cm, 8 "



TROEMMER

10-005-24 24,0 cm, 9 $\frac{1}{2}$ "



RABINER

10-006-23 23,0 cm, 9 "



mit Nadel
 with needle
 con aguja
 con ago

Kopf umsteckbar
 Reversible head
 Cabeza reversible
 Testa pieghevole

BABINSKY

10-007-22 22,0 cm, 8 3/4 "



TRAUBE

10-008-16 16,0 cm, 6 1/4 "



Holz
 Wood
 Madera
 Legno

PINARD

10-010-01 18,0 cm, 7 "



AL
 ALUMINIUM

PINARD

10-010-02 15,0 cm, 6 "



AL
ALUMINIUM

BOWLES

10-011-00 Ø 40,0 mm



AL
ALUMINIUM

für Erwachsene
for adults
para adultos
per adulti

DUPLEX

10-012-01 Ø 47,0 mm



für Kinder
for children
para niños
per bambini

AL
ALUMINIUM

DUPLEX

10-012-02 Ø 37,0 mm



für Säuglinge
for infants
para niños pequeños
per neonati

AL
ALUMINIUM

DUPLEX

10-012-03 Ø 22,0 mm



AL
ALUMINIUM

RI-RAP

10-012-40 40,0 cm, 15 3/4"



AL
ALUMINIUM

RI-RAP

10-012-80 80,0 cm, 31 1/2"



AL
ALUMINIUM

ANESTOPHONE

10-013-00 Ø 48,0 mm



AL
ALUMINIUM

CARDIOPHONE

10-014-00 Ø 36 | 48 mm

Algesimeter mit Nadel und Pinsel
 Algesimeter with needle and brush
 Algesímetro con aguja y cepillo
 Algesiometro con ago e pennello



ALY

10-014-19 19,0 cm, 7 1/2 "

Algesimeter (Nervrädchen)
 Algesimeter (pinwheel)
 Algesímetro (rueda con espinas)
 Algesiometro (rotella neurologica)



WARTENBERG

10-015-18 18,5 cm, 7 1/4 "

Ästhesiometer
 Aesthesiometer
 Estesiometro
 Estesiometro



WEBER

10-016-09 9,5 cm, 3 3/4 "

Meßbereich: 180°
 Measuring range: 180°
 Alcance de medición: 180°
 Campo di misura: 180°



Winkelmesser
 Flexometer
 Goniómetro
 Goniometro

MOELTGEN

10-021-01 23,0 cm, 9 "

Finger-Goniometer
 Finger goniometer
 Goniómetro para dedos
 Goniometro per le dita

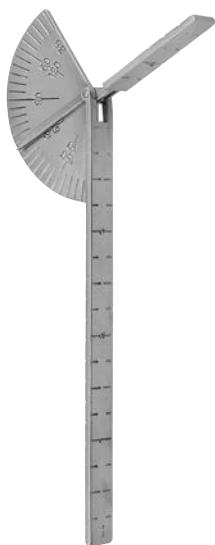

CAROLL

10-021-02 14,5 cm, 5 3/4 "

Meßbereich: 250 mm
 Measuring range: 250 mm
 Alcance de medición: 250 mm
 Campo di misura: 250 mm



BERTILLON

10-023-32 32,0 cm, 12 1/2 "

Dynamometer für Erwachsene
 Dynamometer for adults
 Dinamómetro para adultos
 Dinamometro per adulti



COLLIN

10-024-01 12,5 cm, 5 "

Dynamometer für Kinder
 Dynamometer for children
 Dinamómetro para niños
 Dinamometro per bambini



COLLIN

10-024-02 12,5 cm, 5 "

Mamillerringe, stumpf
 Areola marker, blunt
 Marcadores para areóla, romo
 Marcatori per areola, smusso



10-024-32	Ø 32,0 mm
10-024-37	Ø 37,0 mm
10-024-43	Ø 43,0 mm
10-024-50	Ø 50,0 mm

Mamillerringe, scharf
 Areola marker, sharp
 Marcadores para areóla, agudo
 Marcatori per areola, acuto



10-025-32	Ø 32,0 mm
10-025-37	Ø 37,0 mm
10-025-43	Ø 43,0 mm
10-025-50	Ø 50,0 mm

Maßband, Stahl
 Measuring tape, steel
 Cinta métrica, acero
 Metro a nastro metallico

Maßband, Wachstuch
 Measuring tape, wax cloth
 Cinta métrica, tela encerada
 Metro a nastro in tela cerata

Graduiert in cm und Zoll
 Graduated in cm and inches
 Graduado en cm y pulgadas
 Graduate in e pollici



10-030-15 150 cm, 59 "



10-031-15 150 cm, 59 "

Komplett
 Complete
 Completo
 Completo



VIGORIMETER

10-026-00

10-026-05

3 Ersatzgummibälle
 3 spare rubber bulbs
 3 peras de goma
 3 Palloni di ricambio

10-026-98

Ersatzschlauch
 spare tube
 tubo de repuesto
 tubo di ricambio

10-026-99

Manometer, allein
 manometer, only
 manómetro, suelto
 manometro, solo



Messtab, graduiert in cm und Zoll
Ruler, graduated in cm and inches
Regla, graduado en cm y pulgadas
Misuratori, graduate in e pollici



10-032-10	100 mm
10-032-15	150 mm
10-032-20	200 mm
10-032-30	300 mm
10-032-50	500 mm



Röntgen Messstab
Ruler, X-Ray
Regla para rayos X
Misuratore per raggi X



10-033-50	500 mm
------------------	--------

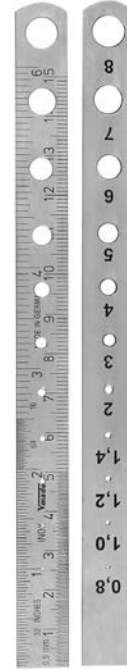

mit Lochlehre
with hole gauge
con calibre de agujeros
calibro forato

10-034-15	150 mm
------------------	--------



TOWNLEY

10-036-11	100 mm
------------------	--------

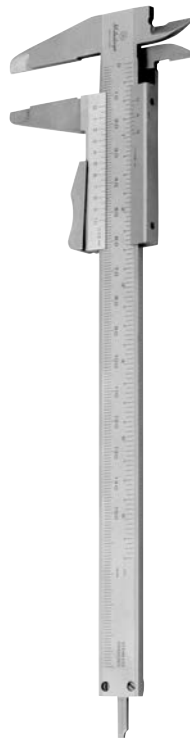

10-036-15	150 mm
------------------	--------



JAMESON

10-036-81	80 mm
------------------	-------

Vergrößerung x 2,5
Magnifying power x 2.5
Aumento x 2,5
Ingrandimento x 2,5



10-037-50 Ø 50 mm

Vergrößerung x 2,5
Magnifying power x 2.5
Aumento x 2,5
Ingrandimento x 2,5



10-037-75 Ø 75 mm

Tonometer, komplett, fabrikgeeicht
Tonometer, complete, calibrated by the manufacturer
Tonómetro, completo, constrastado por la fábrica
Tonometro, completo, verificato dalla fabbrica



10-038-00

Skala schräg
Scale oblique
Escala oblicua
Scala obliqua

10-038-01

Skala gerade
Scale straight
Escala recta
Scala retta

SCHIOETZ

10-038-00 - 10-038-01



mit Klettenmanschette
with velcro cuff
con brazalete de velcro
con bracciale velcro

Messbereich 0 - 300 Hg
Measuring range 0 - 300 Hg
Alcance de medición 0 - 300 Hg
Misurare fino a 0 - 300 Hg



PRECISA

10-039-01

mit Klettenmanschette
with velcro cuff
con brazalete de velcro
con bracciale velcro

Messbereich 0 - 300 Hg
Measuring range 0 - 300 Hg
Alcance de medición 0 - 300 Hg
Misurare fino a 0 - 300 Hg



MAXIMUS

10-040-00

mit Klettenmanschette
with velcro cuff
con brazalete de velcro
con bracciale velcro

Messbereich 0 - 300 Hg
Measuring range 0 - 300 Hg
Alcance de medición 0 - 300 Hg
Misurare fino a 0 - 300 Hg



MINIMUS

10-040-01

mit Klettenmanschette
with velcro cuff
con brazalete de velcro
con bracciale velcro

Messbereich 0 - 300 Hg
Measuring range 0 - 300 Hg
Alcance de medición 0 - 300 Hg
Misurare fino a 0 - 300 Hg



PACHON

10-040-02



mit Klettenmanschette, Quecksilberröhre 300 mm
with velcro cuff, mercury tube 300 mm
avec manchette velcro, tube à mercure 300 mm
con brazaletes de velcro, tubo de mercurio 300 mm

Messbereich 0 - 300 Hg
Measuring range 0 - 300 Hg
Alcance de medición 0 - 300 Hg
Misurare fino a 0 - 300 Hg

DIPLOMAT

10-041-00



mit Klettenmanschette, Quecksilberröhre 300 mm
with velcro cuff, mercury tube 300 mm
avec manchette velcro, tube à mercure 300 mm
con brazaletes de velcro, tubo de mercurio 300 mm

Messbereich 0 - 300 Hg
Measuring range 0 - 300 Hg
Alcance de medición 0 - 300 Hg
Misurare fino a 0 - 300 Hg

10-041-01



Komplett, mit Batterie
Complete, with battery
Completo, con pila
Completo, con pila

LED

10-042-00 6V

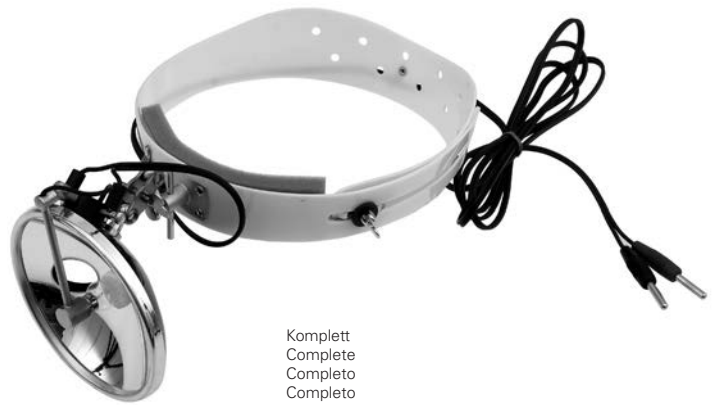

Komplett
Complete
Completo
Completo

CLAR

10-042-01 Ø 100 mm | 6V

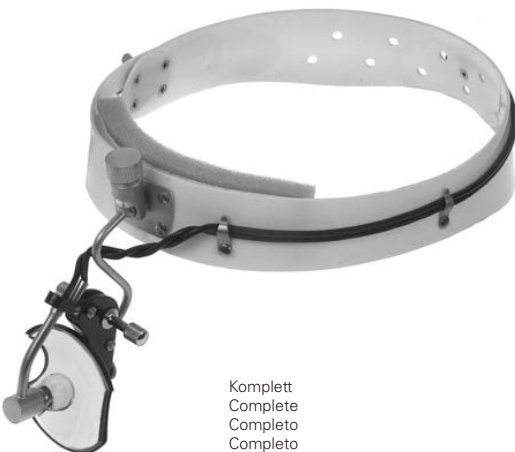

Komplett
Complete
Completo
Completo

CLAR

10-042-02 Ø 55 mm | 6V

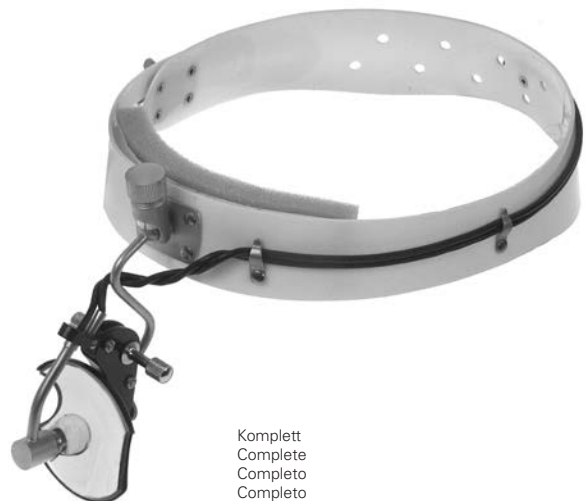

Komplett
Complete
Completo
Completo

CLAR

10-042-03 Ø 98 mm | 6V



Komplett
Complete
Completo
Completo

JANSEN

10-042-04 6 V



Mini-Transformator für 220 Volt Wechselstrom, mit Gummikabel und Steckbuchse für Schwachstrom, stufenlos regelbar 0-10 Volt.

Mini-transformer unit for 220 volts alternating current, with cable and outlet for low voltage current, infinitely variable from 0-10 volts.

Transformador eléctrico pequeño para 220 voltios corriente alterna, con cable y borne para corriente de baja tensión, regulador sin escalones desde 0-10 voltios.

Mini-transformatore elettrico, per 220 volt, corrente alternata a bassa tensione, regolazione continua da 0-10 volt.

10-042-09 0 - 10 V

10-042-05 6 V

Ersatzbirne
Spare bulb
Bombilla de repuesto
Lampadina di ricambio

10-042-95

Stirnband aus Celluloid, allein
Head band of celluloid, only
Cinta frontal de celuloide, suelto
Fascia frontale di celuloide, solo

10-042-96

Ersatz-Schaumgummipolsterung
Spare foam rubber pad
Almohadillade goma-espuma
Imbottitura frontale

10-042-97 Ø 55 mm

Reflektorglas, ohne Fassung
Reflector glass, without socket
Reflector de cristal, sin montura
Riflettore di cristallo, senza montatura

10-042-98 Ø 55 mm

Reflektorglas, mit Fassung
Reflector glass, with socket
Reflector de cristal, con montura
Riflettore di cristallo, con montatura

10-042-99 Ø 100 mm

Reflektorgl , ohne Fassung
Reflector glass, without socket
Reflector de cristal, sin montura
Riflettore di cristallo, senza montatura



ULM CASE I

10-043-00

ULM CASE I Komplett, bestehend aus:

- ULM CASE I mit 2 Ampullen-Streifen für je 13 Ampullen
- Aufkleber Atmung
- Sauerstoff-Gerät
- Gürtel für O2 Zylinder, 2 Stück
- Handbeatmungsbeutel für Erwachsene und Kinder
- Satz Beatmungsmasken, mit aufblasbarem Ventil, Silikon
- Satz Rendell-Baker Beatmungsmasken, Silikon
- Satz oropharyngeal Tubus (Guedel)
- Satz nasopharyngeal Tubus (Wendl)
- OMNIVAC Absaug-Apparat mit 250 ml Auffangbehälter, mit Düse
- Halter für OMNIVAC Beatmungsgerät
- Satz Absaugkatheter
- Laryngoskope, Metall, mit 2 McIntosh Zungendrucker (Grösse 1 und 2), mit Batterien
- Satz Trachealkanülen, Einmalgebrauch
- Satz medizinische Kleinteile
- Intubation Set

ULM CASE I completo, consta de

- Botiquín ULM CASE I con dos barras ampulario, cada una con capacidad para 13 ampollas
- Set de etiquetas para equipos respiratorios
- Botella de oxígeno
- Correas para la sujeción de una botella de oxígeno, 2 unidades
- Reanimador manual para adultos y pediátrico
- Set de máscaras respiratorias, con sellado inflable en silicona
- Set de máscaras respiratorias Rendell-Baker en silicona
- Set de cánulas orofaríngeas (Güedel)
- Set de cánulas nasofaríngeas (Wendl)
- Equipo de aspiración OMNIVAC con recipiente recolector de 250 ml, con inyector
- Soporte para el respirador OMNIVAC
- Set de sondas de aspiración
- Laringoscopio, metálico, con 2 sujetalenguas de McIntosh (tamaños 1 y 2), con baterías
- Set de cánulas traqueales, un solo uso
- Set de artículos sanitarios pequeños
- Set de intubación

ULM CASE I complete, consisting of:

- ULM CASE I with 2 ampoule strips for 13 ampoules each
- Set of Respiration labels
- Oxygen device
- Belts for O2 cylinders, 2 pcs.
- COMBIBAG Resuscitator for adults and children
- Set of ventilation masks, with inflatable mask, seal of silicone
- Set of Rendell-Baker ventilation masks, silicone
- Set of oropharyngeal tubes (Guedel)
- Set of nasopharyngeal tubes (Wendl)
- OMNIVAC suction equipment with 250 ml collection canister, with injector
- Holder for OMNIVAC aspiration equipment
- Set of suction catheters
- Laryngoscopes, metal, with 2 McIntosh tongue depressors (Sizes 1 and 3), with batteries
- Set of disposable tracheal tubes
- Set of small medical products
- Intubation set

ULM CASE I completo, composta da:

- VALIGIA ULM I con 2 portafiale da 13 fiale ciascuna
- Adesivi farmaci respirazione
- Apparecchio per ossigeno
- Cinghiette per bombola di ossigeno, 2 pezzi
- Pallone per la respirazione manuale per adulti e bambini
- Set maschere per la respirazione con valvola gonfiabile, silicone
- Set maschere per la respirazione Rendell-Baker, silicone
- Set tubo orofaringeo (Güedel)
- Set tubo nasofaringeo (Wendl)
- Sistema di aspirazione OMNIVAC dotato di contenitore di raccolta da 250 ml e ugello
- Supporto per apparecchio per respirazione OMNIVAC
- Set catetere di aspirazione
- Laringoscopio, metallo, con 2 abbassalingua McIntosh (dimensione 1 e 2), con batterie
- Set cannule tracheali, monouso
- Set piccola strumentazione medica
- Set di intubazione

Komplett mit zwei Manschetten (10-045-01 | 10-045-02) und Pumpe, Messbereich 0 - 700 Hg
 Complete with two cuffs (10-045-01 | 10-045-02) and pump, Measuring range 0 - 700 Hg
 Completo con dos brazaletes (10-045-01 | 10-045-02) y bomba de aire, Alcance de medición 0 - 700 Hg
 Completo con due bracciali (10-045-01 | 10-045-02) e pompa d'aria, Misurare fino a 0 - 700 Hg



10-045-00



10-045-01 57 x 9 cm

Oberarm-Manschette
 Cuff for upper arm
 Brazaletes para el brazo
 Bracciali per braccio

10-045-02 96 x 13 cm

Oberschenkel-Manschette
 Cuff for thigh
 Brazaletes para el muslo
 Bracciare per coscia

10-045-03 39 x 8 cm

Kinder-Manschette
 Cuff for children
 Brazaletes para niños
 Bracciare per bambini



FRANCKE

10-046-00



10-047-00

Staubinde, 5 m
 Compression bandage, 5 m
 Venda-compresión, 5 m
 Fascia per ischemia, 5 m



10-047-06 6,0 cm, 2 1/3 "
 10-047-08 8,0 cm, 3 "
 10-047-10 10,0 cm, 4 "



RI-SCOPE

10-048-00 2,5V

Opthalmoskopbesteck komplett in Etui, bestehend aus:

- 1 Batteriehandgriff (ohne Batterien)
- 1 Ophthalmoskop mit Halogenbirne, 2,5 V
- 1 Lupe, 5-fache Vergrößerung
- 1 Ersatzbirnchen, Halogen, 2,5 V

Ophthalmoscope Set complete in case, consisting of:

- 1 Battery handle (without batteries)
- 1 Ophthalmoscope with halogen bulb, 2,5 V
- 1 Magnifying glass, 5 x
- 1 Spare bulb, halogen, 2,5 V

Juego para Oftalmología completo en estuche, consta de

- 1 Mango de pilas (sin pilas)
- 1 Oftalmoscopio con bombilla de halógeno, 2,5 V
- 1 Lupa, aumento 5 x
- 1 Bombilla de repuesto, 2,5 V

Set per oftalmologia completo in astuccio, composta da:

- 1 Manico per pila (senza pila)
- 1 Testa di oftalmoscopio con lampadina alogena, 2,5 V
- 1 Lente, ingrandimento 5 x
- 1 Lampadina di ricambio, alogena, 2,5 V



RI-SCOPE

10-048-01 2,5V

Diagnostikbesteck komplett in Etui, bestehend aus:

- 1 Batteriehandgriff (ohne Batterien)
- 1 Ophthalmoskop mit Halogenbirne, 2,5 V
- 1 Otoskopkopf mit Halogenbirne, 2,5 V
- 1 Wiederverwendbare Ohrtrichter, Ø 2,0 | 3,0 | 4,0 | 5,0 mm
- 3 Einwegohrtrichter, Ø 2,5 | 4,0 mm
- 1 Operationslupe, 4-fache Vergrößerung
- 2 Ersatzbirnchen, Halogen, 2,5 V

Diagnostic Set complete in case, consisting of:

- 1 Battery handle (without batteries)
- 1 Ophthalmoscope with halogen bulb, 2,5 V
- 1 Otoloscope head with halogen bulb, 2,5 V
- 1 Reusable ear specula, Ø 2,0 | 3,0 | 4,0 | 5,0 mm
- 3 Disposable ear specula, Ø 2,5 | 4,0 mm
- 1 Magnifying glass for operation, 4 x
- 2 Spare bulb, halogen, 2,5 V

Juego de Diagnóstico completo en estuche, consta de

- 1 Mango de pilas (sin pilas)
- 1 Oftalmoscopio con bombilla de halógeno, 2,5 V
- 1 Cabeza de otoscopio con bombilla de halógeno, 2,5 V
- 1 Espéculos auriculares reutilizables, Ø 2,0 | 3,0 | 4,0 | 5,0 mm
- 3 Espéculos auriculares desechables, Ø 2,5 | 4,0 mm
- 1 Lupa para operaciones, aumento 4 x
- 2 Bombilla de repuesto, 2,5 V

Set per Diagnostica completo in astuccio, composta da:

- 1 Manico per pila (senza pila)
- 1 Testa di oftalmoscopio con lampadina alogena, 2,5 V
- 1 Testa di otoscopio con lampadina alogena, 2,5 V
- 1 Specolo auricolare riutilizzabile, Ø 2,0 | 3,0 | 4,0 | 5,0 mm
- 3 Specolo auricolare monouso, Ø 2,5 | 4,0 mm
- 1 Lente per operazione, ingrandimento 4 x
- 2 Lampadina di ricambio, alogena, 2,5 V



RI-SCOPE

10-048-02 2,5 V

Universal Diagnostikbesteck komplett in Etui, bestehend aus:

- 1 Batteriehandgriff (ohne Batterien)
- 1 Ophthalmoskop mit Halogenbirne, 2,5 V
- 1 Otoskopkopf mit Halogenbirne, 2,5 V
- 1 Nasenspekulum mit Lampe und Lupe
- 1 Mundspatelhalter mit Lampe
- 1 Lampenträger mit Lampe
- 1 Kehlkopfspiegel für Lampenträger, Ø 20,0 | 22,0 mm
- 1 Wiederverwendbare Ohrtrichter, Ø 2,0 | 3,0 | 4,0 | 5,0 mm
- 3 Einwegohrtrichter, Ø 2,5 | 4,0 mm
- 2 Ersatzbirnchen, Halogen, 2,5 V

Universal Diagnostic Set complete in case, consisting of:

- 1 Battery handle (without batteries)
- 1 Ophthalmoscope with halogen bulb, 2,5 V
- 1 Otoscope head with halogen bulb, 2,5 V
- 1 Nasal specula with bulb and magnifier
- 1 Tongue depressor holder with bulb
- 1 Lamp holder with bulb
- 1 Laryngeal mirrors for lamp holder, Ø 20,0 | 22,0 mm
- 1 Reusable ear specula, Ø 2,0 | 3,0 | 4,0 | 5,0 mm
- 3 Disposable ear specula, Ø 2,5 | 4,0 mm
- 2 Spare bulb, halogen, 2,5 V

Universal juego de Diagnóstico completo en estuche, consta de

- 1 Mango de pilas (sin pilas)
- 1 Oftalmoscopio con bombilla de halógeno, 2,5 V
- 1 Cabeza de otoscopio con bombilla de halógeno, 2,5 V
- 1 Espéculo nasal con bombilla y lupa
- 1 Soporte de bajalengua con bombilla
- 1 Porta bombilla con bombilla incluida
- 1 Espejos laringeos para el porta-bombilla, Ø 20,0 | 22,0 mm
- 1 Espéculos auriculares reutilizables, Ø 2,0 | 3,0 | 4,0 | 5,0 mm
- 3 Espéculos auriculares desechables specolo auricolare
- 2 Bombilla de repuesto, 2,5 V

Universal Set per Diagnostica completo in astuccio, composta da:

- 1 Manico per pila (senza pila)
- 1 Testa di oftalmoscopio con lampadina alogena, 2,5 V
- 1 Testa di otoscopio con lampadina alogena, 2,5 V
- 1 Specolo nasale con lampada
- 1 Spatola abbassalingua con lampada
- 1 Porta-lampada con lampada
- 1 Specchietti auricolari per porta-lampada, Ø 20,0 | 22,0 mm
- 1 Specolo auricolare riutilizzabile, Ø 2,0 | 3,0 | 4,0 | 5,0 mm
- 3 Specolo auricolare monouso, Ø 2,5 | 4,0 mm
- 2 Lampadina di ricambio, alogena, 2,5 V



RI-SCOPE

10-048-05 2,5V

HNO Diagnostikbesteck komplett in Etui, bestehend aus:

- 1 Batteriehandgriff (ohne Batterien)
- 1 Otoskopkopf mit Halogenbirne, 2,5 V
- 1 Nasenspekulum mit Lampe und Lupe
- 1 Mundspatelhalter mit Lampe
- 1 Operationslupe, 4-fache Vergrößerung
- 1 Wiederverwendbare Ohrtrichter, Ø 2,0 | 3,0 | 4,0 | 5,0 mm
- 3 Einwegohrtrichter, Ø 2,5 | 4,0 mm
- 1 Ersatzbirnchen, Halogen, 2,5 V

ENT Diagnostic Set complete in case, consisting of:

- 1 Battery handle (without batteries)
- 1 Otoscope head with halogen bulb, 2,5 V
- 1 Nasal specula with bulb and magnifier
- 1 Tongue depressor holder with bulb
- 1 Magnifying glass for operation, 4 x
- 1 Reusable ear specula, Ø 2,0 | 3,0 | 4,0 | 5,0 mm
- 3 Disposable ear specula, Ø 2,5 | 4,0 mm
- 1 Spare bulb, halogen, 2,5 V

ORL juego de Diagnóstico completo en estuche, consta de

- 1 Mango de pilas (sin pilas)
- 1 Cabeza de otoscopio con bombilla de halógeno, 2,5 V
- 1 Espéculo nasal con bombilla y lupa
- 1 Soporte de bajalengua con bombilla
- 1 Lupa para operaciones, aumento 4 x
- 1 Espéculos auriculares reutilizables, Ø 2,0 | 3,0 | 4,0 | 5,0 mm
- 3 Espéculos auriculares desechables specolo auricolare
- 1 Bombilla de repuesto, 2,5 V

ORL Set per Diagnostica completo in astuccio, composta da:

- 1 Manico per pila (senza pila)
- 1 Testa di otoscopio con lampadina alogena, 2,5 V
- 1 Specolo nasale con lampada
- 1 Spatola abbassalingua con lampada
- 1 Lente per operazione, ingrandimento 4 x
- 1 Specolo auricolare riutilizzabile, Ø 2,0 | 3,0 | 4,0 | 5,0 mm
- 3 Specolo auricolare monouso, Ø 2,5 | 4,0 mm
- 1 Lampadina di ricambio, alogena, 2,5 V



RI-SCOPE

10-048-18 2,5 V

Otoskopbesteck komplett in Etui, bestehend aus:

- 1 Batteriehandgriff (ohne Batterien)
- 1 Otoskopkopf mit Halogenbirne, 2,5 V
- 1 Wiederverwendbare Ohrtrichter, Ø 2,0 | 3,0 | 4,0 | 5,0 mm
- 3 Einwegohrtrichter, Ø 2,5 | 4,0 mm
- 1 Operationslupe, 4-fache Vergrößerung
- 1 Ersatzbirnchen, Halogen, 2,5 V

Otoscope Set complete in case, consisting of:

- 1 Battery handle (without batteries)
- 1 Otoscope head with halogen bulb, 2,5 V
- 1 Reusable ear specula, Ø 2,0 | 3,0 | 4,0 | 5,0 mm
- 3 Disposable ear specula, Ø 2,5 | 4,0 mm
- 1 Magnifying glass for operation, 4 x
- 1 Spare bulb, halogen, 2,5 V

Juego para otoscopia completo en estuche, consta de

- 1 Mango de pilas (sin pilas)
- 1 Cabeza de otoscopio con bombilla de halógeno, 2,5 V
- 1 Espéculos auriculares reutilizables, Ø 2,0 | 3,0 | 4,0 | 5,0 mm
- 3 Espéculos auriculares desechables, Ø 2,5 | 4,0 mm
- 1 Lupa para operaciones, aumento 4 x
- 1 Bombilla de repuesto, 2,5 V

Set di otoscopia completo in astuccio, composta da:

- 1 Manico per pila (senza pila)
- 1 Testa di otoscopio con lampadina alogena, 2,5 V
- 1 Specolo auricolare riutilizzabile, Ø 2,0 | 3,0 | 4,0 | 5,0 mm
- 3 Specolo auricolare monouso, Ø 2,5 | 4,0 mm
- 1 Lente per operazione, ingrandimento 4 x
- 1 Lampadina di ricambio, alogena, 2,5 V

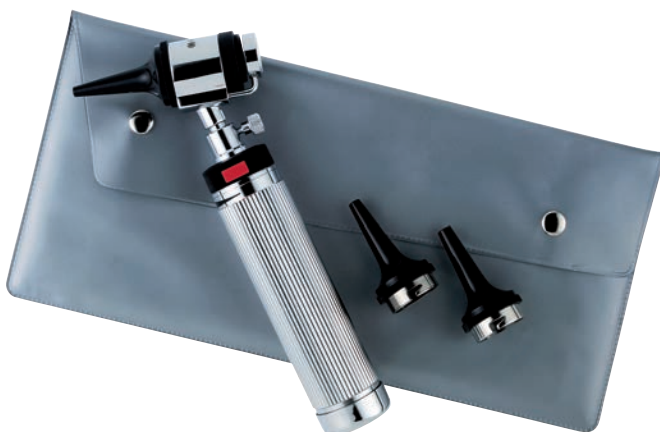

UNI I

10-048-15 2,7 V

Otoskopbesteck komplett in Etui, bestehend aus:

- 1 Batteriehandgriff (ohne Batterien)
- 1 Otoskopkopf mit Vaccumbirne, 2,7 V
- 1 Wiederverwendbare Ohrtrichter, Ø 2,0 | 3,0 | 4,0 mm

Otoscope Set complete in case, consisting of:

- 1 Battery handle (without batteries)
- 1 Otoscope head with vacuum bulb, 2,7 V
- 1 Reusable ear specula, Ø 2,0 | 3,0 | 4,0 mm

Juego para otoscopia completo en estuche, consta de

- 1 Mango de pilas (sin pilas)
- 1 Cabeza de otoscopio con bombilla de vacío, 2,7 V
- 1 Espéculos auriculares reutilizables, Ø 2,0 | 3,0 | 4,0 mm

Set di otoscopia completo in astuccio, composta da:

- 1 Manico per pila (senza pila)
- 1 Testa di otoscopio con lampadina sotto vuoto, 2,7 V
- 1 Specolo auricolare riutilizzabile, Ø 2,0 | 3,0 | 4,0 mm



UNI II

10-048-20 2,7V

Ophtalmoskopbesteck komplett in Etui, bestehend aus:

- 1 Batteriehandgriff (ohne Batterien)
- 1 Ophtalmoskopkopf mit Vaccumbirne, 2,7V

Opthalmoscope Set complete in case, consisting of:

- 1 Battery handle (without batteries)
- 1 Opthalmoscope head with vaccum bulb, 2,7V

Juego para oftalmología completo en estuche, consta de

- 1 Mango de pilas (sin pilas)
- 1 Cabeza de oftalmología con bombilla de vacío, 2,7V

Set di oftalmologia completo in astuccio, composta da:

- 1 Manico per pila (senza pila)
- 1 Testa di oftalmologia con lampadina sotto vuoto, 2,7V

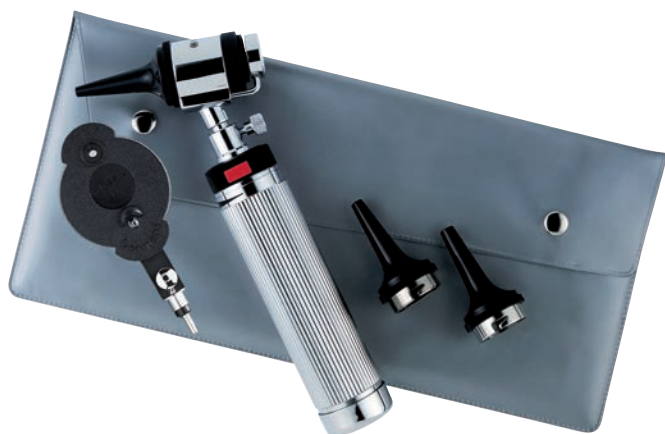

UNI III

10-048-19 2,7V

Diagnostikbesteck komplett in Etui, bestehend aus:

- 1 Batteriehandgriff (ohne Batterien)
- 1 Ophtalmoskopkopf mit Vaccumbirne, 2,7V
- 1 Otoskopkopf mit Vaccumbirne, 2,7V
- 1 Wiederverwendbare Ohrtrichter, Ø 2,0 | 3,0 | 4,0 mm

Diagnostic Set complete in case, consisting of:

- 1 Battery handle (without batteries)
- 1 Opthalmoscope head with vaccum bulb, 2,7V
- 1 Otoscope head with vaccum bulb, 2,7V
- 1 Reusable ear specula, Ø 2,0 | 3,0 | 4,0 mm

Juego de Diagnóstico completo en estuche, consta de

- 1 Mango de pilas (sin pilas)
- 1 Cabeza de oftalmología con bombilla de vacío, 2,7V
- 1 Cabeza de otoscopio con bombilla de vacío, 2,7V
- 1 Espéculos auriculares reutilizables, Ø 2,0 | 3,0 | 4,0 mm

Set per Diagnostica completo in astuccio, composta da:

- 1 Manico per pila (senza pila)
- 1 Testa di oftalmologia con lampadina sotto vuoto, 2,7V
- 1 Testa di otoscopio con lampadina sotto vuoto, 2,7V
- 1 Specolo auricolare riutilizzabile, Ø 2,0 | 3,0 | 4,0 mm

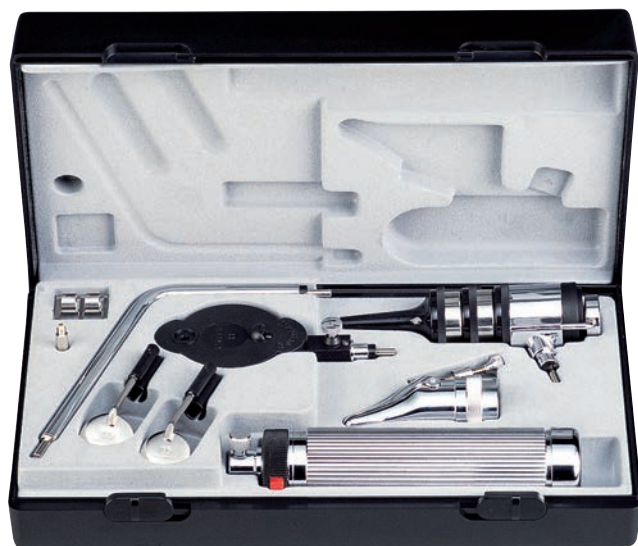

PREMIUM

10-048-30 2,7 V

Diagnostikbesteck komplett in Etui, bestehend aus:

- 1 Batteriehandgriff (ohne Batterien)
- 1 Ophthalmoskop mit Vaccumbirne, 2,7 V
- 1 Otoskopkopf mit Vaccumbirne, 2,7 V
- 1 Wiederverwendbare Ohrtrichter, Ø 2,0 | 3,0 | 4,0 mm
- 1 Nasenspekulum
- 1 Lampenträger
- 1 Kehlkopfspiegel für Lampenträger, Ø 20,0 | 22,0 mm
- 1 Mundspatelhalter
- 1 Ersatzbirnchen, Vacuum, 2,7 V

Diagnostic Set complete in case, consisting of:

- 1 Battery handle (without batteries)
- 1 Ophthalmoscope with vacuum bulb, 2,7 V
- 1 Otoscope head with vacuum bulb, 2,7 V
- 1 Reusable ear specula, Ø 2,0 | 3,0 | 4,0 mm
- 1 Nasal specula
- 1 Lampenträger
- 1 Laryngeal mirrors for lamp holder, Ø 20,0 | 22,0 mm
- 1 Tongue depressor holder
- 1 Spare bulb, vacuum, 2,7 V

Juego de Diagnóstico completo en estuche, consta de

- 1 Mango de pilas (sin pilas)
- 1 Oftalmoscopio con bombilla de vacío, 2,7 V
- 1 Cabeza de otoscopio con bombilla de vacío, 2,7 V
- 1 Espéculos auriculares reutilizables, Ø 2,0 | 3,0 | 4,0 mm
- 1 Espéculo nasal
- 1 Porta bombilla
- 1 Espejos laringeos para el porta-bombilla, Ø 20,0 | 22,0 mm
- 1 Soporte de bajalengua
- 1 Bombilla de repuesto, vacío, 2,7 V

Set per Diagnostica completo in astuccio, composta da:

- 1 Manico per pila (senza pila)
- 1 Testa di oftalmoscopio con lampadina sotto vuoto, 2,7 V
- 1 Testa di otoscopio con lampadina sotto vuoto, 2,7 V
- 1 Specolo auricolare riutilizzabile, Ø 2,0 | 3,0 | 4,0 mm
- 1 Specolo nasale
- 1 Porta-lampada
- 1 Specchietti auricolari per porta-lampada, Ø 20,0 | 22,0 mm
- 1 Soporte de bajalengua
- 1 Lampadina di ricambio, sotto vuoto, 2,7 V



Reflexspiegel, komplett
Reflex head mirror, complete
Espejo frontal, completo
Specchio frontale, completo

ZIEGLER

10-049-00 Ø 90,0 mm

Stirnband aus weißem Celluloid mit Gelenk
Head band of white celluloid with joint
Cinta de celuloide blanc con articulación
Fascia frontale di celluloid bianca con snodo sferico



MURPHY

10-049-15

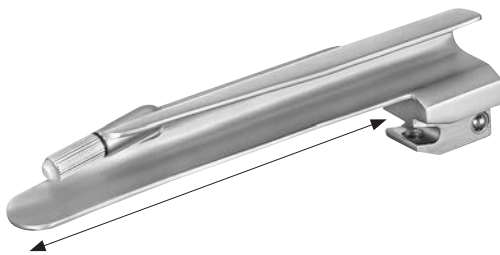

NEGUS (GUEDEL)

- 10-050-01** Fig 1 | 73 mm
- 10-050-02** Fig 2 | 102 mm
- 10-050-03** Fig 3 | 110 mm
- 10-050-04** Fig 4 | 135 mm



Fig. 0 Neugeborene Newborns Recién nacidos Neonati	Fig. 3 Erwachsene (klein) Adult (small) Adultos (pequeño) Adulti (piccolo)
Fig. 1 Kleinkinder Infants Niños pequeños Bambini in età da allattamento	Fig. 4 Erwachsene (mittel) Adult (medium) Adultos (mediano) Adulti (medio)
Fig. 2 Kinder Children Niños Bambini	Fig. 5 Erwachsene (groß) Adult (large) Adultos (grande) Adulti (grande)



10-063-11 2,5 V

Ersatzbirne, Fig. 1
Spare bulb, Fig. 1
Bombilla de repuesto, Fig. 1
Lampadina di ricambio, Fig. 1



10-063-12 2,5 V

Ersatzbirne, Fig. 2 - 4
Spare bulb, Fig. 2 - 4
Bombilla de repuesto, Fig. 2 - 4
Lampadina di ricambio, Fig. 2 - 4



NEGUS (GUEDEL)

10-070-00 Fig. 1 - 2

Satz, komplett im Etui, bestehend aus:
Set, complete in case, consisting of:
Juego, completo en estuche, compuesto de:
Set, completo di custodia, composto da:

- 1 Griff, handle, mango, manico (10-061-00)
- 1 Spatel, blade, spatula, lame Fig. 1 - 2 (10-050-01 | 10-050-02)

NEGUS (GUEDEL)

10-071-00 Fig. 1 - 4

Satz, komplett im Etui, bestehend aus:
Set, complete in case, consisting of:
Juego, completo en estuche, compuesto de:
Set, completo di custodia, composto da:

- 1 Griff, handle, mango, manico (10-061-00)
- 1 Spatel, blade, spatula, lame Fig. 1 - 4 (10-050-01 - 10-050-04)

J



MILLER

- 10-051-00** Fig 0 | 55 mm
- 10-051-01** Fig 1 | 80 mm
- 10-051-02** Fig 2 | 130 mm
- 10-051-03** Fig 3 | 170 mm
- 10-051-04** Fig 4 | 180 mm



10-063-11 2,5 V

Ersatzbirne, Fig. 0 - 1
 Spare bulb, Fig. 0 - 1
 Bombilla de repuesto, Fig. 0 - 1
 Lampadina di ricambio, Fig. 0 - 1



10-063-12 2,5 V

Ersatzbirne, Fig. 2 - 4
 Spare bulb, Fig. 2 - 4
 Bombilla de repuesto, Fig. 2 - 4
 Lampadina di ricambio, Fig. 2 - 4

Fig. 0	Fig. 3
Neugeborene Newborns Recién nacidos Neonati	Erwachsene (klein) Adult (small) Adultos (pequeño) Adulti (piccolo)
Fig. 1	Fig. 4
Kleinkinder Infants Niños pequeños Bambini in età da allattamento	Erwachsene (mittel) Adult (medium) Adultos (mediano) Adulti (medio)
Fig. 2	Fig. 5
Kinder Children Niños Bambini	Erwachsene (groß) Adult (large) Adultos (grande) Adulti (grande)



MILLER

10-073-00 Fig. 2 - 4

Satz, komplett im Etui, bestehend aus:
 Set, complete in case, consisting of:
 Juego, completo en estuche, compuesto de:
 Set, completo di custodia, composto da:

- 1 Griff, handle, mango, manico (10-061-00)
- 1 Spatel, blade, espatula, lame Fig. 2 - 4 (10-051-02 - 10-051-04)

MILLER

10-074-00 Fig. 1 - 4

Satz, komplett im Etui, bestehend aus:
 Set, complete in case, consisting of:
 Juego, completo en estuche, compuesto de:
 Set, completo di custodia, composto da:

- 1 Griff, handle, mango, manico (10-061-00)
- 1 Spatel, blade, espatula, lame Fig. 1 - 4 (10-051-01 - 10-051-04)



MC INTOSH

10-052-00	Fig 0 56 mm
10-052-01	Fig 1 68 mm
10-052-02	Fig 2 88 mm
10-052-03	Fig 3 108 mm
10-052-04	Fig 4 128 mm
10-052-05	Fig 5 150 mm



10-063-11 2,5 V

Ersatzbirne, Fig. 0
Spare bulb, Fig. 0
Bombilla de repuesto, Fig. 0
Lampadina di ricambio, Fig. 0



10-063-12 2,5 V

Ersatzbirne, Fig. 1 - 5
Spare bulb, Fig. 1 - 5
Bombilla de repuesto, Fig. 1 - 5
Lampadina di ricambio, Fig. 1 - 5

Fig. 0 Neugeborene Newborns Recién nacidos Neonati	Fig. 3 Erwachsene (klein) Adult (small) Adultos (pequeño) Adulti (piccolo)
Fig. 1 Kleinkinder Infants Niños pequeños Bambini in età da allattamento	Fig. 4 Erwachsene (mittel) Adult (medium) Adultos (mediano) Adulti (medio)
Fig. 2 Kinder Children Niños Bambini	Fig. 5 Erwachsene (groß) Adult (large) Adultos (grande) Adulti (grande)



MC INTOSH

10-076-00 Fig. 1 - 3

Satz, komplett im Etui, bestehend aus:
Set, complete in case, consisting of:
Juego, completo en estuche, compuesto de:
Set, completo di custodia, composto da:

- 1 Griff, handle, mango, manico (10-061-00)
- 1 Spatel, blade, espatula, lame Fig. 1 - 3 (10-052-01 - 10-050-03)

MC INTOSH

10-076-01 Fig. 2 - 4

Satz, komplett im Etui, bestehend aus:
Set, complete in case, consisting of:
Juego, completo en estuche, compuesto de:
Set, completo di custodia, composto da:

- 1 Griff, handle, mango, manico (10-061-00)
- 1 Spatel, blade, espatula, lame Fig. 2 - 4 (10-050-02 - 10-050-04)

MC INTOSH

10-077-00 Fig. 1 - 4

Satz, komplett im Etui, bestehend aus:
Set, complete in case, consisting of:
Juego, completo en estuche, compuesto de:
Set, completo di custodia, composto da:

- 1 Griff, handle, mango, manico (10-061-00)
- 1 Spatel, blade, espatula, lame Fig. 1 - 4 (10-052-01 - 10-052-04)

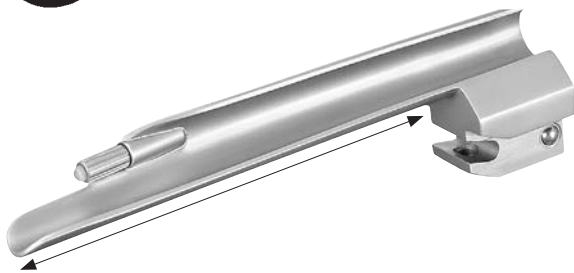

WIS-FOREGGER

10-053-00	Fig 0 73 mm
10-053-01	Fig 1 93 mm
10-053-02	Fig 2 111 mm
10-053-03	Fig 3 140 mm
10-053-04	Fig 4 165 mm



STEEL
STAINLESS

Fig. 0	Fig. 3
Neugeborene Newborns Recién nacidos Neonati	Erwachsene (klein) Adult (small) Adultos (pequeño) Adulti (piccolo)
Fig. 1	Fig. 4
Kleinkinder Infants Niños pequeños Bambini in età da allattamento	Erwachsene (mittel) Adult (medium) Adultos (mediano) Adulti (medio)
Fig. 2	Fig. 5
Kinder Children Niños Bambini	Erwachsene (groß) Adult (large) Adultos (grande) Adulti (grande)



10-063-11 2,5 V

Ersatzbirne, Fig. 0 - 1
 Spare bulb, Fig. 0 - 1
 Bombilla de repuesto, Fig. 0 - 1
 Lampadina di ricambio, Fig. 0 - 1



10-063-12 2,5 V

Ersatzbirne, Fig. 2 - 4
 Spare bulb, Fig. 2 - 4
 Bombilla de repuesto, Fig. 2 - 4
 Lampadina di ricambio, Fig. 2 - 4



WIS-FOREGGER

10-078-00 Fig. 2 - 4

Satz, komplett im Etui, bestehend aus:
 Set, complete in case, consisting of:
 Juego, completo en estuche, compuesto de:
 Set, completo di custodia, composto da:

1 Griff, handle, mango, manico (10-061-00)
 1 Spatel, blade, espatula, lame Fig. 2 - 4 (10-053-02 - 10-053-04)

WIS-FOREGGER

10-079-00 Fig. 1 - 4

Satz, komplett im Etui, bestehend aus:
 Set, complete in case, consisting of:
 Juego, completo en estuche, compuesto de:
 Set, completo di custodia, composto da:

1 Griff, handle, mango, manico (10-061-00)
 1 Spatel, blade, espatula, lame Fig. 1 - 4 (10-053-01 - 10-053-04)

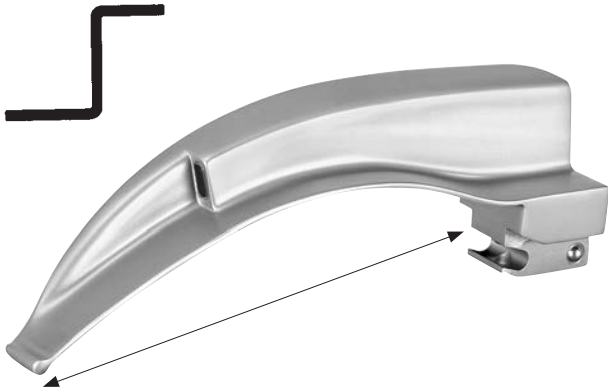

MC INTOSH

10-054-00	Fig 0 56 mm
10-054-01	Fig 1 68 mm
10-054-02	Fig 2 88 mm
10-054-03	Fig 3 108 mm
10-054-04	Fig 4 128 mm



Laryngoskop-Spatel mit integriertem Kaltlichtträger
Laryngoscope blade with integrated cold light carrier
Espátulas de laringoscopios con luz fría integrada
Spatole per laringoscopia, luce fredda

Fig. 0	Fig. 3
Neugeborene Newborns Recién nacidos Neonati	Erwachsene (klein) Adult (small) Adultos (pequeño) Adulti (piccolo)
Fig. 1	Fig. 4
Kleinkinder Infants Niños pequeños Bambini in età da allattamento	Erwachsene (mittel) Adult (medium) Adultos (mediano) Adulti (medio)
Fig. 2	Fig. 5
Kinder Children Niños Bambini	Erwachsene (groß) Adult (large) Adultos (grande) Adulti (grande)



MC INTOSH

10-081-00 Fig. 1 - 3

Satz, komplett im Etui, bestehend aus:
Set, complete in case, consisting of:
Juego, completo en estuche, compuesto de:
Set, completo di custodia, composto da:

1 Griff, handle, mango, manico (10-065-00)
1 Spatel, blade, espatula, lame Fig. 1 - 3 (10-054-01 - 10-054-03)

MC INTOSH

10-082-00 Fig. 1 - 4

Satz, komplett im Etui, bestehend aus:
Set, complete in case, consisting of:
Juego, completo en estuche, compuesto de:
Set, completo di custodia, composto da:

1 Griff, handle, mango, manico (10-065-00)
1 Spatel, blade, espatula, lame Fig. 1 - 4 (10-054-01 - 10-054-04)

J



MILLER

- 10-055-00** Fig 0 | 55 mm
- 10-055-01** Fig 1 | 80 mm
- 10-055-02** Fig 2 | 130 mm
- 10-055-03** Fig 3 | 170 mm
- 10-055-04** Fig 4 | 180 mm



Laryngoskop-Spatel mit integriertem Kaltlichtträger
 Laryngoscope blade with integrated cold light carrier
 Espátulas de laringoscopios con luz fría integrada
 Spatole per laringoscopia, luce fredda

Fig. 0	Fig. 3
Neugeborene Newborns Recién nacidos Neonati	Erwachsene (klein) Adult (small) Adultos (pequeño) Adulti (piccolo)
Fig. 1	Fig. 4
Kleinkinder Infants Niños pequeños Bambini in età da allattamento	Erwachsene (mittel) Adult (medium) Adultos (mediano) Adulti (medio)
Fig. 2	Fig. 5
Kinder Children Niños Bambini	Erwachsene (groß) Adult (large) Adultos (grande) Adulti (grande)



MILLER

10-083-00 Fig. 2 - 4

Satz, komplett im Etui, bestehend aus:
 Set, complete in case, consisting of:
 Juego, completo en estuche, compuesto de:
 Set, completo di custodia, composto da:

- 1 Griff, handle, mango, manico (10-065-00)
- 1 Spatel, blade, espatula, lame Fig. 2 - 4 (10-055-02 - 10-055-04)

MILLER

10-084-00 Fig. 1 - 4

Satz, komplett im Etui, bestehend aus:
 Set, complete in case, consisting of:
 Juego, completo en estuche, compuesto de:
 Set, completo di custodia, composto da:

- 1 Griff, handle, mango, manico (10-065-00)
- 1 Spatel, blade, espatula, lame Fig. 1 - 4 (10-055-01 - 10-055-04)



Batteriegriff (2 AA Batterien, 1,5 Volt, sind erforderlich)
Battery handle (2 AA batteries, 1.5 volt, are required)
Mango de pila (senecesitan 2 pilas AA de 1,5 V)
Manico per pila (2 pile AA di 1,5 volt sono necessarie)

10-060-00 Ø 18,0 mm



Batteriegriff (2 A Batterien, 1,5 Volt, sind erforderlich)
Battery handle (2 A batteries, 1.5 volt, are required)
Mango de pila (senecesitan 2 pilas A de 1,5 V)
Manico per pila (2 pile A di 1,5 volt sono necessarie)

10-061-00 Ø 30,0 mm

Batteriegriff (1 A Batterien, 1,5 Volt, sind erforderlich)
Battery handle (1 A batteries, 1.5 volt, are required)
Mango de pila (senecesitan 1 pilas A de 1,5 V)
Manico per pila (1 pile A di 1,5 volt sono necessarie)



10-062-00 Ø 30,0 mm



Batteriegriff (für Trafoanschluß)
Battery handle (for transformer)
Mango de pila (para Transformador)
Manico per pila (per Trasformatore)

10-063-00 Ø 30,0 mm

Transformator
Transformer
Transformador
Trasformatore



10-063-01 220 V

Batterieladegerät
Battery charging device
Cargador de batería
Caricabatteria per batterie



10-063-03



Batteriegriff (2 AA Batterien, 1,5 Volt, sind erforderlich)
 Battery handle (2 AA batteries, 1.5 volt, are required)
 Mango de pila (se necesitan 2 pilas AA de 1,5 V)
 Manico per pila (2 pile AA di 1,5 volt sono necessarie)

10-064-00 Ø 18,0 mm



Batteriegriff (2 A Batterien, 1,5 Volt, sind erforderlich)
 Battery handle (2 A batteries, 1.5 volt, are required)
 Mango de pila (se necesitan 2 pilas A de 1,5 V)
 Manico per pila (2 pile A di 1,5 volt sono necessarie)

10-065-00 Ø 30,0 mm



Batteriegriff (für Trafoanschluß)
 Battery handle (for transformer)
 Mango de pila (para Transformador)
 Manico per pila (per Trasformatore)

10-065-01 Ø 30,0 mm



10-069-03 2,5 V

LED Lampe
 LED bulb
 Lámpara de LED
 Lampadina LED



10-069-02 2,5 V

Xenon Lampe
 Xenon bulb
 Lámpara de halógeno
 Lampadina alogena



10-069-01 2,5 V

Halogen Lampe
 Halogen bulb
 Lámpara de xenón
 Lampadina xenon



10-069-00 2,5 V

Krypton Lampe
 Krypton bulb
 Lámpara de criptón
 Lampadina krypton



LED

10-069-30 Ø 30,0 mm

Griff mit Akku (10-069-39)
 Handle with accumulator (10-069-39)
 Mango con acumulador (10-069-39)
 Manico con accumulatore (10-069-39)



LED

10-069-40 115 V

10-069-50 230 V

Ladegerät
 Charging device
 Cargador
 Ricaricatore



BAYHA I Fig. 1

10-100-01 13,0 cm, 5 1/8"



BAYHA I Fig. 2

10-100-02 13,0 cm, 5 1/8"



BAYHA I Fig. 3

10-100-03 20,0 cm, 8"



BAYHA I Fig. 4

10-100-04 16,0 cm, 6 1/4"



BAYHA I Fig. 5

10-100-05 15,0 cm, 6"



Nr. 3

10-103-01 12,0 cm, 4 3/4"



Fig. 10-15C



Nr. 3

10-103-03 12,0 cm, 4 3/4"



Fig. 10-15C



Nr. 3 L

10-103-04 21,0 cm, 8 1/4"



Fig. 10-15C



Fig.
10-15C

Nr. 3 L

10-103-05 20,5 cm, 8"



Fig.
10-15C

Nr. 7

10-103-06 16,0 cm, 6 ¼"



Fig.
10-15C

Nr. 7 K

10-103-07 13,0 cm, 5"



Fig.
10-15C

Nr. 3

10-103-08 21,5 cm, 8 ½"



Fig.
10-15C

Nr. 3 L

10-103-09 21,5 cm, 8 ½"



PE
PLASTIC
Fig.
10-15C

Nr. 3

10-103-10 12,5 cm, 5"



Fig.
10-15C

Nr. 3

10-103-11 15,5 cm, 6 ⅛"



Fig.
10-15C

Nr. 3

10-103-12 14,5 cm, 5 ¾"



Fig.
10-15C

Nr. 3

10-103-13 14,5 cm, 5 3/4"



Fig.
10-15C

Nr. 3

10-103-14 15,0 cm, 6"



Fig.
10-36D

Nr. 3 + 4

10-103-34 16,0 cm, 6 1/4"



Fig.
18-36D

Nr. 4

10-104-01 13,5 cm, 5 1/4"



Fig.
18-36D

Nr. 4 L

10-104-04 21,0 cm, 8 1/4"



Fig.
18-36D

Nr. 4 L

10-104-05 21,0 cm, 8 1/4"



Fig.
18-36D

Nr. 4

10-104-08 21,5 cm, 8 1/2"



PE
PLASTIC
Fig.
18-36D

Nr. 4

10-104-10 13,5 cm, 5 1/4"



Fig.
10-15C

Nr. 5

10-105-01 16,0 cm, 6 1/4"



Fig.
18-36D

COLLIN I Nr. 8

10-108-00 13,5 cm, 5 1/4"



Fig.
18-36D

COLLIN I Nr. 9

10-109-00 14,5 cm, 5 3/4"



Verpackungseinheit: 10 St.
 Packing unit: 10 pieces
 Unidad: 10 piezas
 Confezione: 10 pezzi

Rasierklingen, brechbar
 Razor blades, breakable
 Hojas de afeitador, rompibles
 Lamette di rasoio, per rompere



STEEL
 STAINLESS

10-116-00



TROUTMAN-CHRIS

10-110-10 9,0 cm, 3 1/2"



TROUTMAN-CHRIS

10-111-10 9,0 cm, 3 1/2"



10-112-11 11,0 cm, 4 3/8"



CASTROVIEJO

10-114-13 13,0 cm, 5 1/8"





Verpackungseinheit: 100 St.
Packing unit: 100 pieces
Unidad: 100 piezas
Confezione: 100 pezzi



10-199-00 Fig. 10 - 36D

Skalpellklingen-Entferner
Scalpel-Blade Remover
Quita hojas
Distributore lame



Fig. 10

10-153-10



Fig. 11

10-153-11

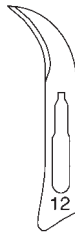

Fig. 12

10-153-12



Fig. 13

10-153-13

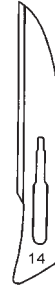

Fig. 14

10-153-14



Fig. 15

10-153-15



Fig. 15c

10-153-55



Fig. 18

10-154-18



Fig. 19

10-154-19



Fig. 20

10-154-20

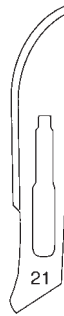

Fig. 21

10-154-21



Verpackungseinheit: 100 St.
Packing unit: 100 pieces
Unidad: 100 piezas
Confezione: 100 pezzi



Fig. 22

10-154-22



Fig. 23

10-154-23



Fig. 24

10-154-24

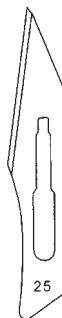

Fig. 25

10-154-25

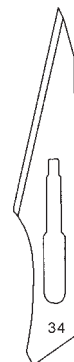

Fig. 34

10-154-34



Fig. 36

10-154-36

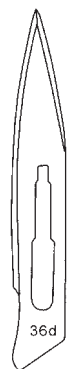

Fig. 36D

10-154-37

 Verpackungseinheit: 10 St.
Packing unit: 10 pieces
Unidad: 100 piezas
Confezione: 10 pezzi



Fig. 10
10-253-10



Fig. 11
10-253-11



Fig. 12
10-253-12



Fig. 13
10-253-13



Fig. 15
10-253-15



Fig. 15C
10-253-51



Fig. 18
10-254-18



Fig. 19
10-254-19



Fig. 20
10-254-20



Fig. 21
10-254-21



Fig. 22
10-254-22



Fig. 23
10-254-23



Fig. 24
10-254-24



Fig.
61-69

10-260-10 10,0 cm, 4"

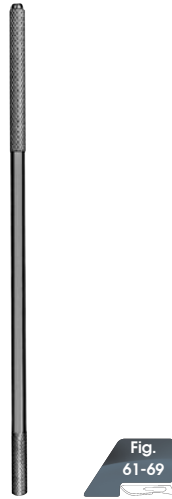

Fig.
61-69

10-260-13 13,0 cm, 5 1/8"

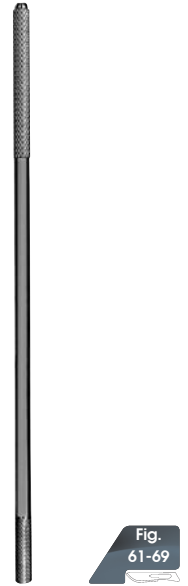

Fig.
61-69

10-260-15 15,5 cm, 6 1/8"

 Verpackungseinheit: 10 St.
Packing unit: 10 pieces
Unidad: 10 piezas
Confezione: 10 pezzi



FIG. 61

10-265-61

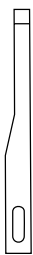

FIG. 62

10-265-62



FIG. 62S

10-265-63



FIG. 64

10-265-64



FIG. 65

10-265-65



FIG. 67

10-265-67



FIG. 69

10-265-69

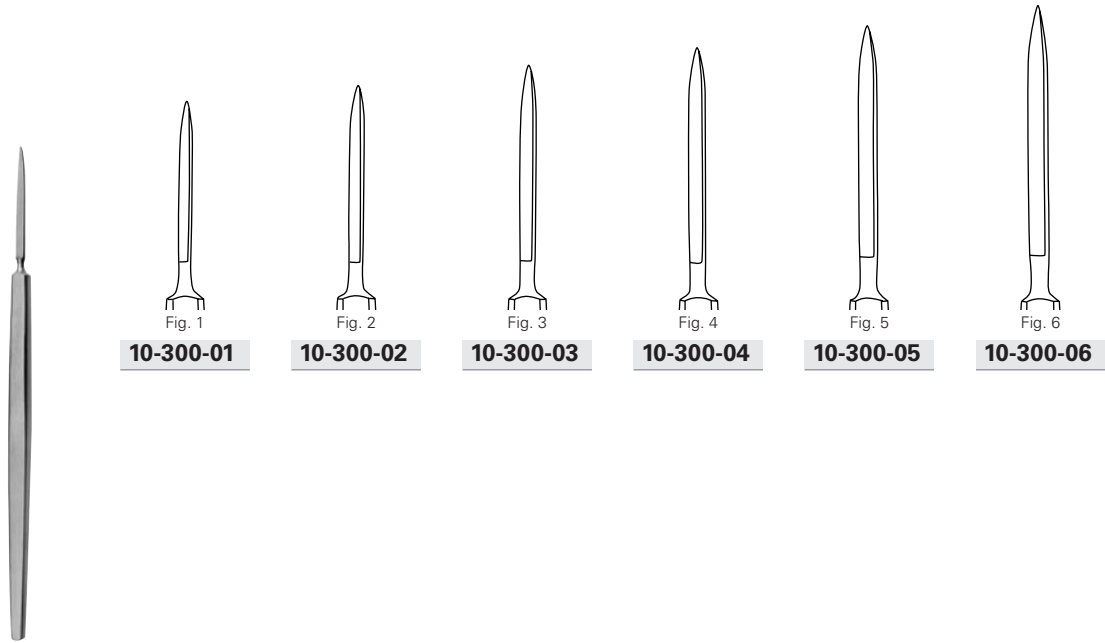

GRAEFE

10-300-01 - 10-300-06 13,0 cm, 5 1/8"

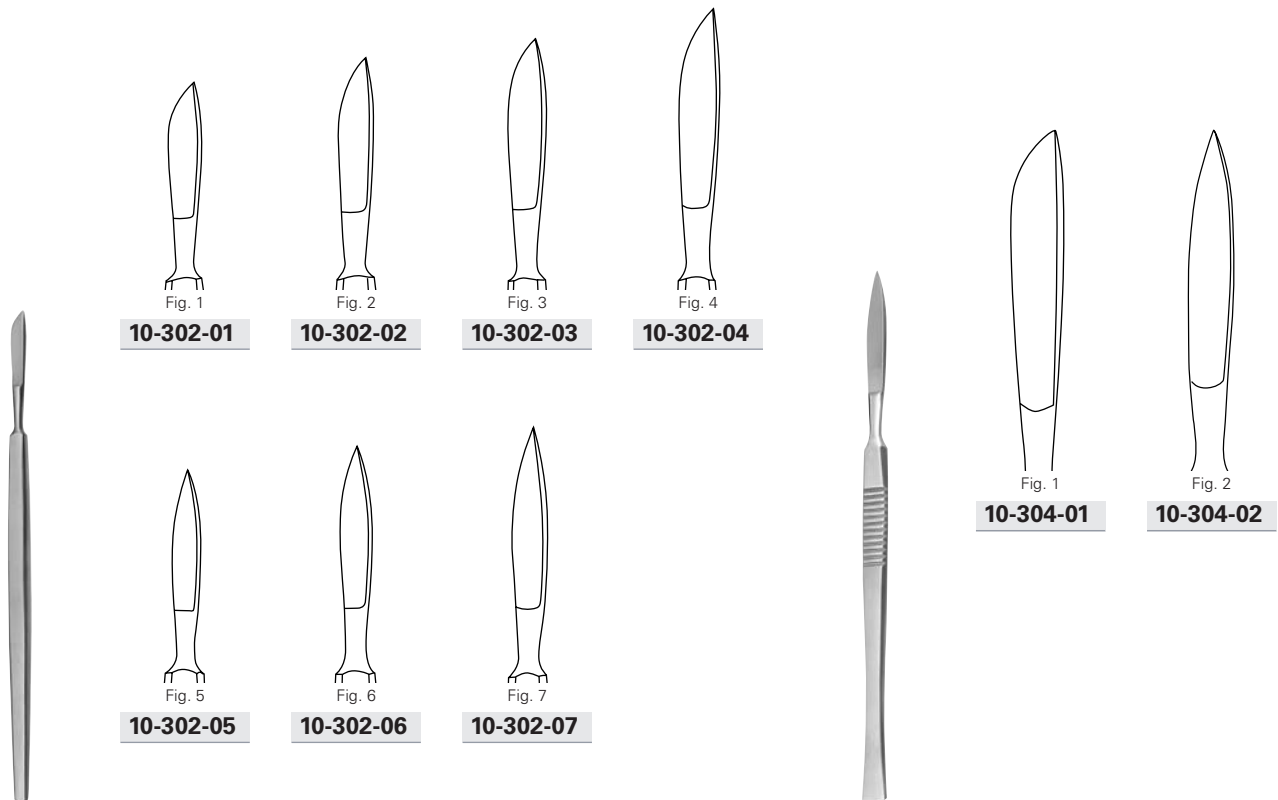

GRAEFE

10-302-01 - 10-302-07 13,0 cm, 5 1/8"

BERGMANN

10-304-01 - 10-304-02 14,0 cm, 5 1/2"



Amputationsmesser
Amputating Knives
Cuchillo para amputación
Coltello per amputazione

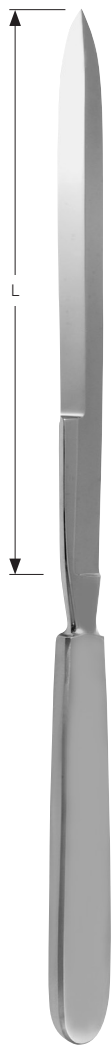

Amputationsmesser
Amputating Knives
Cuchillo para amputación
Coltello per amputazione

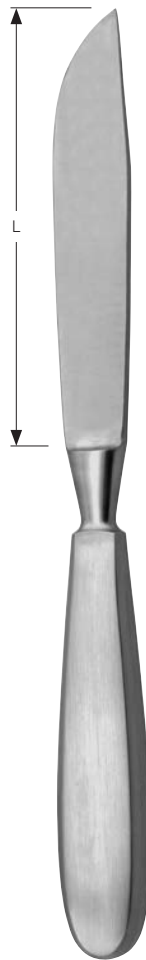

Amputationsmesser
Amputating knife
Cuchillo para amputación
Coltello per amputazione

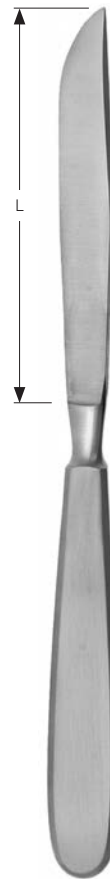

Phalangenmesser
Phalangeal knife
Cuchillo para lóbulus
Coltello per lobi

LISTON

10-320-13	13,0 cm, 5 1/8"
10-320-16	16,0 cm, 6 1/4"
10-320-19	19,0 cm, 7 1/2"
10-320-22	22,0 cm, 8 3/4"
10-320-28	28,0 cm, 11"

CATLIN

10-322-16	16,0 cm, 6 1/4"
10-322-19	19,0 cm, 7 1/2"
10-322-22	22,0 cm, 8 3/4"

LANGENBECK

10-324-12	13,0 cm, 4 3/4"	10-326-10	10,5 cm, 4 1/4"
------------------	-----------------	------------------	-----------------



Zwischenknochenmesser
 Interosseous knife
 Cuchillo interóseo
 Coltello interosseo



Beinhautmesser
 Periosteum knife
 Cuchillo para periostio
 Coltello per periosti



Resektionsmesser
 Resection knife
 Cuchillo para resección
 Coltello per resezione



Resektionsmesser
 Resection knife
 Cuchillos para resección
 Coltelli per resezione

LANGENBECK

LANGENBECK

10-328-11 10,5 cm, 4 1/4"

10-330-06 6,5 cm, 2 1/2"

10-332-01 5,5 cm, 2 1/8"

10-332-02 5,5 cm, 2 1/8"

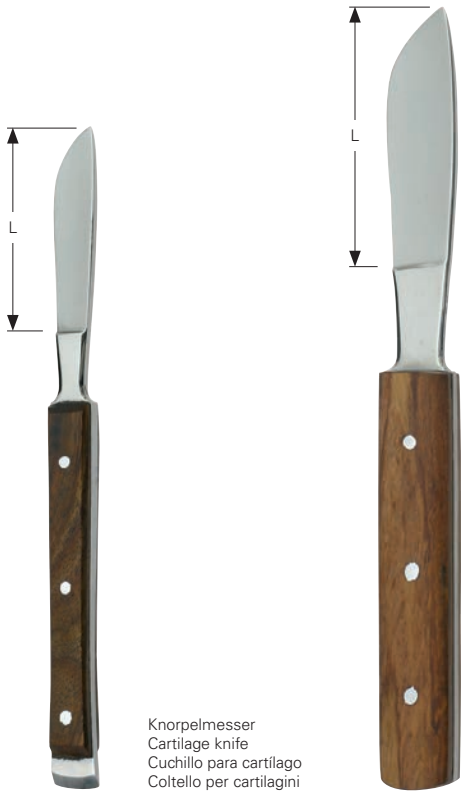

Knorpelmesser
Cartilage knife
Cuchillo para cartilago
Coltello per cartilagini

Knorpelmesser
Cartilage knife
Cuchillo para cartilago
Coltello per cartilagini

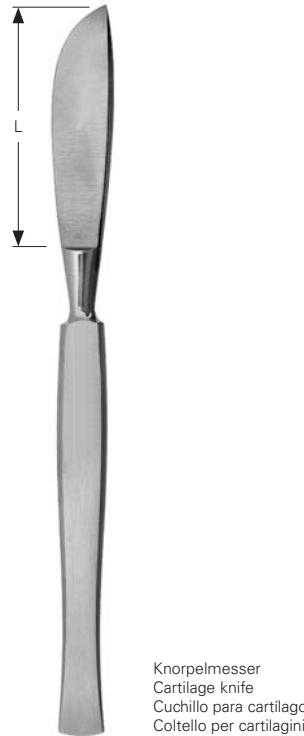

Knorpelmesser
Cartilage knife
Cuchillo para cartilago
Coltello per cartilagini

Seziermesser
Autopsy knife
Cuchillo para autopsia
Coltello per autopsie

10-334-01 5,5 cm, 2 1/8"

10-334-02 7,0 cm, 2 3/4"

10-336-01 5,5 cm, 2 1/8"

10-338-08 8,5 cm, 3 3/8"

VIRCHOW

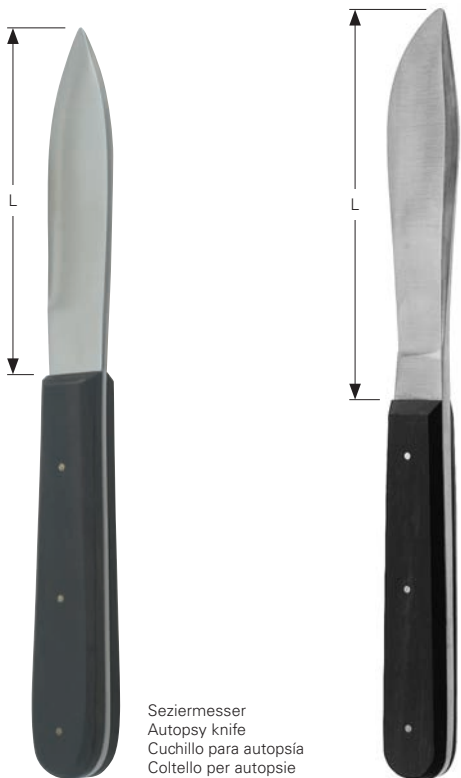

Seziermesser
Autopsy knife
Cuchillo para autopsia
Coltello per autopsie

Seziermesser
Autopsy knife
Cuchillo para autopsia
Coltello per autopsie

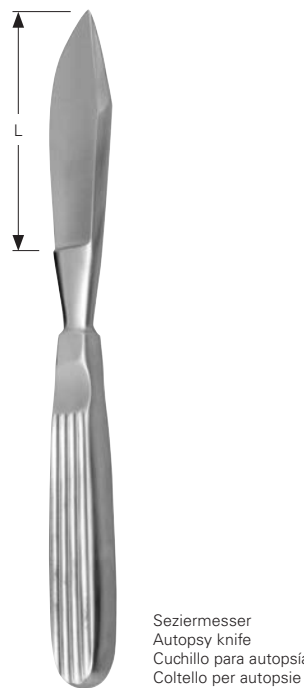

Seziermesser
Autopsy knife
Cuchillo para autopsia
Coltello per autopsie

Seziermesser
Autopsy knife
Cuchillo para autopsia
Coltello per autopsie

VIRCHOW

10-340-09 9,5 cm, 3 3/8"

10-340-11 11,5 cm, 4 1/4"

10-342-08 8,0 cm, 3 1/8"

10-344-10 10,0 cm, 4"

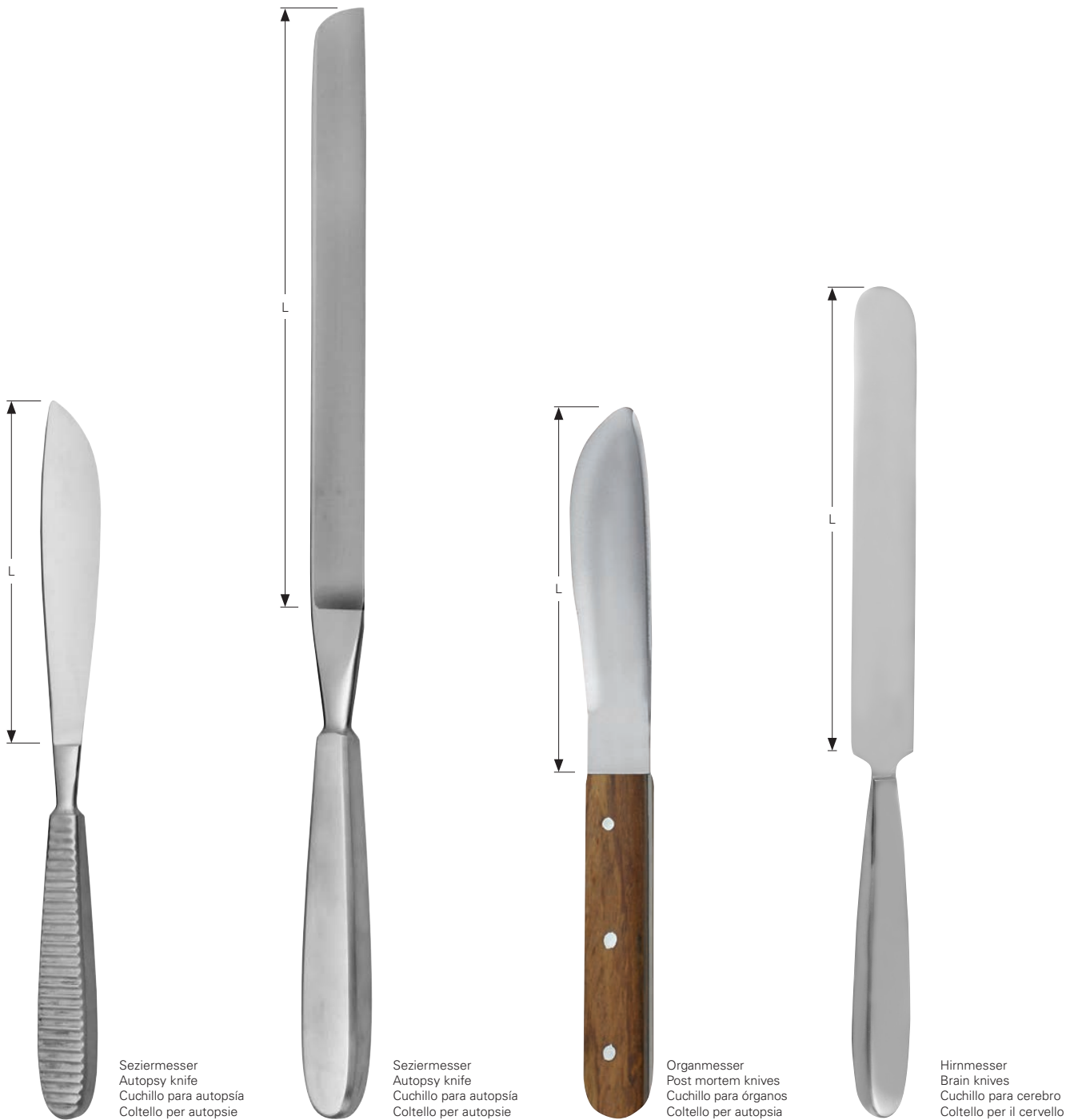

Seziermesser
 Autopsy knife
 Cuchillo para autopsia
 Coltello per autopsie

Seziermesser
 Autopsy knife
 Cuchillo para autopsia
 Coltello per autopsie

Organmesser
 Post mortem knives
 Cuchillo para órganos
 Coltello per autopsia

Hirnmesser
 Brain knives
 Cuchillo para cerebro
 Coltello per il cervello

WALB

VIRCHOW

10-344-13 13,0 cm, 5 1/8"

10-344-19 19,5 cm, 7 3/4"

10-350-11	11,0 cm, 4 3/8"
10-350-14	14,0 cm, 5 1/2"
10-350-17	17,0 cm, 6 3/4"

10-360-16	16,0 cm, 6 1/4"
10-360-20	20,0 cm, 8"
10-360-24	24,0 cm, 9 1/2"



Fig. 1

10-362-01



Fig. 2

10-362-02



Fig. 3

10-362-03

Fistelmesser
Fistula knives
Bisturías para fístulas
Bisturi per fistole

SIMON

10-362-01 - 10-362-03 20,0 cm, 8 "



Fistelmesser
Fistula knife
Bisturías para fístulas
Bisturi per fistole

ULRICH

10-364-22 22,5 cm, 9 "



10-365-23

Konisationsmesser
Cone knife
Bisturías para cono
Bisturi per cono

AYRE

10-365-23 23,5 cm, 9 ¼ "

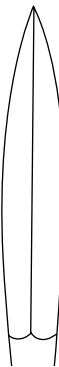

10-366-22

Fistelmesser
Fistula knife
Bisturías para fístulas
Bisturi per fistole

SCHROEDER

10-366-22 22,0 cm, 8 ⅜ "



10-367-23

Konisationsmesser
Cone knife
Bisturías para cono
Bisturi per cono

10-367-23 23,0 cm, 9 "

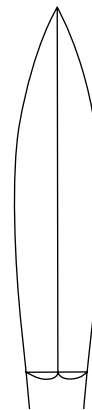

10-368-26

Myommesser
Myoma knife
Bisturías para fibroma
Bisturi per fibromi

SECOND

10-368-26 - 10-368-27 27,0 cm, 10 ¾ "

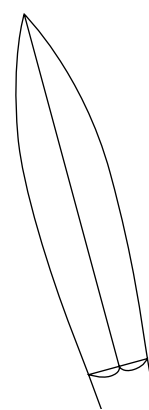

10-368-27



Trigenimusmesser
 Trigeminal knife
 Bisturíe para nervio trgémimo
 Bisturi per nervo trigemino

OLIVECRONA

10-369-20 20,5 cm, 8 "



Tonsillmesser
 Tonsil knife
 Bisturíe para amígdalas
 Bisturi per tonsille

FOWLER

10-371-20 20,0 cm, 8 "



Tonsillmesser
 Tonsil knife
 Bisturíe para amígdalas
 Bisturi per tonsille

ABRAHAM

10-371-21 21,5 cm, 8 ½ "



Tonsillmesser
 Tonsil knife
 Bisturíe para amígdalas
 Bisturi per tonsille

BRUENINGS

10-371-22 21,5 cm, 8 ½ "



10-374-13

Abszessmesser
 Abscess knife
 Bisturíe para absceso
 Bisturi per ascesso



ZIEGLER

10-374-13 13,0 cm, 5 ⅛ "



Duramesser
 Dura knives
 Bisturíe para dura-madré
 Bisturi per dura-madre



10-378-01



10-378-02



10-378-03

10-378-01 - 10-378-03 12,0 cm, 4 ¾ "



TOENNIS

10-380-13 13,0 cm, 5 ⅛ "

Duramesser
 Dura knife
 Bisturíe para dura-madré
 Bisturi per dura-madre



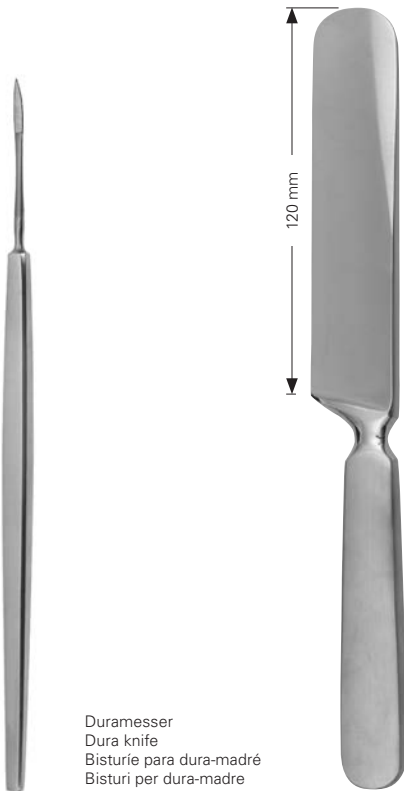

Duramesser
Dura knife
Bisturie para dura-madré
Bisturi per dura-madre

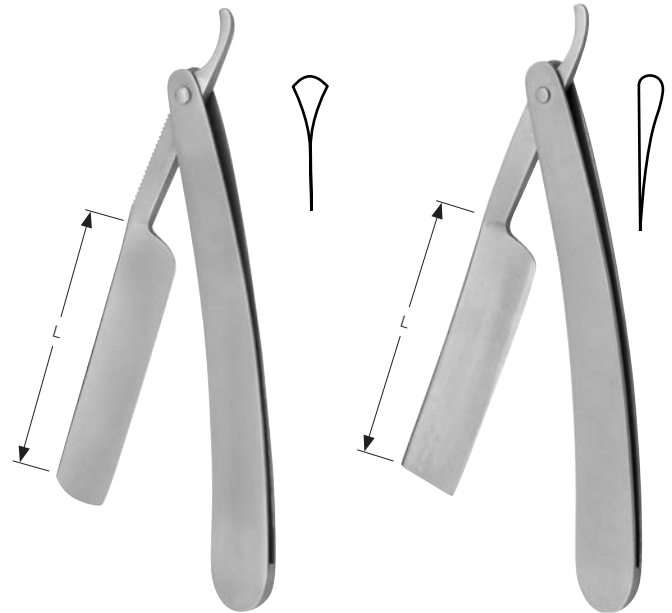

TOENNIS

10-380-19 19,0 cm, 7 1/2"

10-388-23 23,0 cm, 9"

10-390-00 7,5 cm, 3"

10-391-00 8,0 cm, 3 1/8"



Abziehstein
Sharpening stone
Piedra afiladore
Pietra per affilare

ARKANSAS

10-398-00 10,0 x 4,0 cm



Abziehstein
Sharpening stone
Piedra afiladore
Pietra per affilare

ARKANSAS

10-399-00 15,0 x 5,0 cm



0,1 - 3,0 mm
 max. 100 mm

10-400-01

Ersatzklinge
 Spare blade
 Hoja de repuesto
 Lama di ricambio

SCHINK

10-400-00 30,0 cm, 11 3/4"

Spannplatte
 Skin graft plate
 Placa para extender la piel
 Placca per stendere la pelle

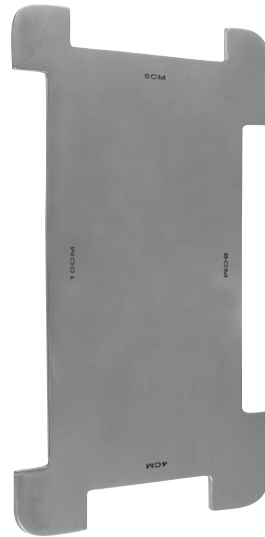

SCHINK

10-400-02 40 - 100 mm



0,1 - 4,0 mm

10-402-20

Ersatzklinge
 Spare blade
 Hoja de repuesto
 Lama di ricambio

SILVER

10-402-19 19,0 cm, 7 1/2"

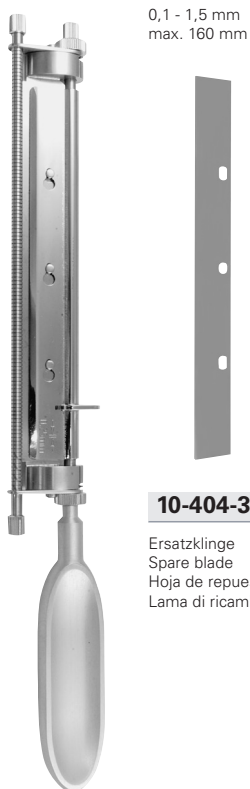

0,1 - 1,5 mm
 max. 160 mm

10-404-32

Ersatzklinge
 Spare blade
 Hoja de repuesto
 Lama di ricambio

HUMBY

10-404-31 32,0 cm, 12"

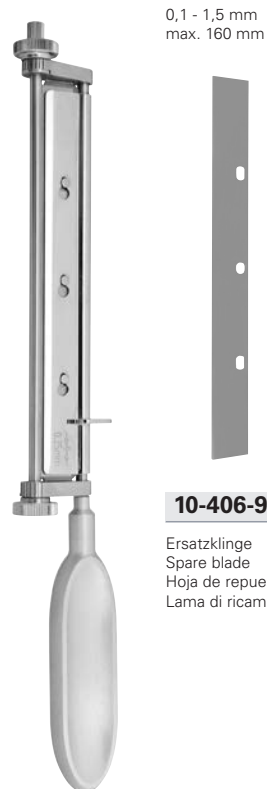

0,1 - 1,5 mm
 max. 160 mm

10-406-99

Ersatzklinge
 Spare blade
 Hoja de repuesto
 Lama di ricambio

WATSON

10-406-30 30,0 cm, 11 3/4"



0,1 - 1,5 mm
 max. 160 mm

10-406-99

Ersatzklinge
 Spare blade
 Hoja de repuesto
 Lama di ricambio

COBBETT

10-406-31 32,0 cm, 12"



10-411-14

Lupusschaber
Lupus scraper
Rascador para lupus
Raschiatoio per lupus

VIDAL

10-411-14 14,0 cm, 5 1/2"



2,0 mm

10-412-02

3,0 mm

10-412-03

4,0 mm

10-412-04

5,0 mm

10-412-05

6,0 mm

10-412-06

Lupusküretten
Lupus curettes
Curetas para lupus
Curette per lupus

FOX

10-412-02 - 10-412-06 14,0 cm, 5 1/2"



Fig. 1

10-414-01



Fig. 2

10-414-02



Fig. 3

10-414-03



Fig. 4

10-414-04



Fig. 5

10-414-05



Fig. 6

10-414-06

Lupusküretten
Lupus curettes
Curetas para lupus
Curette per lupus

WOLFF

10-414-01 - 10-414-06 14,0 cm, 5 1/2"



Ø 2,0 mm

10-420-02

Ø 3,0 mm

10-420-03

Ø 4,0 mm

10-420-04

Ø 5,0 mm

10-420-05

Ø 6,0 mm

10-420-06

Ø 7,0 mm

10-420-07

Ø 8,0 mm

10-420-08

Hauttrephine
Dermal punch
Trépanos para piel
Trefine cutanee

KEYES

10-420-02 - 10-420-08 11,0 cm, 4 3/8"

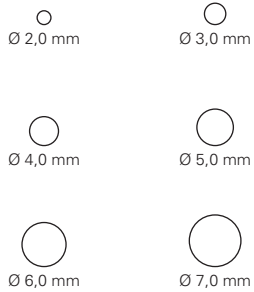

Hautrephine Set
 Dermal punch set
 Juego de trépanos para piel
 Set per trefine cutanee



Komedoneninstrument
 Comedone extractor
 Extractore para comedones
 Tiracomedoni

UNNA

10-422-00 Ø 2,0 - 7,0 mm



Komedoneninstrument
 Comedone extractor
 Extractore para comedones
 Tiracomedoni

UNNA

10-433-14 14,5 cm, 5 3/4 "



Komedoneninstrument
 Comedone extractor
 Extractore para comedones
 Tiracomedoni

SAALFELD

10-435-11 11,0 cm, 4 3/8 "



Komedoneninstrument
 Comedone extractor
 Extractore para comedones
 Tiracomedoni

SAALFELD

10-437-14 14,5 cm, 5 3/4 "



Komedoneninstrument
 Comedone extractor
 Extractore para comedones
 Tiracomedoni

SCHAMBERG

10-439-09 9,5 cm, 3 3/4 "



Komedoneninstrument
 Comedone extractor
 Extractore para comedones
 Tiracomedoni

KATSCH

10-441-14 14,0 cm, 5 1/2 "

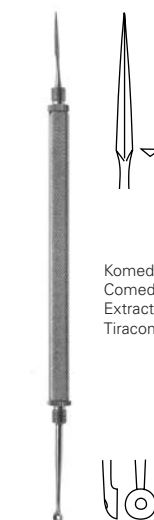

Komedoneninstrument
 Comedone extractor
 Extractore para comedones
 Tiracomedoni

UNNA-VIDAL

10-446-11 11,5 cm, 4 1/2 "



Ø 1,0 mm



Ø 1,5 mm



Ø 2,0 mm



Ø 2,0 mm

mit Ohr
with eye
con ojete
con occhio

10-600-11	11,5 cm, 4 1/2"
10-600-13	13,0 cm, 5 1/8"
10-600-14	14,5 cm, 5 3/4"
10-600-16	16,0 cm, 6 1/4"
10-600-18	18,0 cm, 7"
10-600-20	20,0 cm, 8"
10-600-25	25,0 cm, 9 3/4"

10-601-11	11,5 cm, 4 1/2"
10-601-13	13,0 cm, 5 1/8"
10-601-14	14,5 cm, 5 3/4"
10-601-16	16,0 cm, 6 1/4"
10-601-18	18,0 cm, 7"
10-601-20	20,0 cm, 8"
10-601-25	25,0 cm, 9 3/4"

10-602-11	11,5 cm, 4 1/2"
10-602-13	13,0 cm, 5 1/8"
10-602-14	14,5 cm, 5 3/4"
10-602-16	16,0 cm, 6 1/4"
10-602-18	18,0 cm, 7"
10-602-20	20,0 cm, 8"
10-602-25	25,0 cm, 9 3/4"
10-602-30	30,0 cm, 11 3/4"

10-604-11	11,5 cm, 4 1/2"
10-604-13	13,0 cm, 5 1/8"
10-604-14	14,5 cm, 5 3/4"
10-604-16	16,0 cm, 6 1/4"
10-604-18	18,0 cm, 7"
10-604-20	20,0 cm, 8"

Tränenkanalsonden
Lachrymal probes
Estilete para el canal lacrimal
Stilette per canale lacrimale



Ø 2,0 mm

Myrtenblattsonden
Myrtle leaf probes
Sonda de mirto
Sonde a foglia di mirto

10-606-13	13,0 cm, 5 1/8"
10-606-14	14,5 cm, 5 3/4"
10-606-16	16,0 cm, 6 1/4"
10-606-18	18,0 cm, 7"
10-606-20	20,0 cm, 8"



STACKE

10-608-10	10,5 cm, 4 1/4"
------------------	-----------------



BOWMAN

10-609-00	Fig. 000/00
10-609-01	Fig. 00/0
10-609-02	Fig. 1/2
10-609-03	Fig. 3/4
10-609-04	Fig. 5/6
10-609-05	Fig. 7/8



Tränenkanalsonde
 Lachrymal probe
 Estilete para el canal lacrimal
 Stilette per canale lacrimale

CASTROVIEJO

10-610-01 14,0 cm, 5 1/2"



Tränenkanalsonden
 Lachrymal probes
 Estilete para el canal lacrimal
 Stilette per canale lacrimale

WILDER

10-610-02 - 10-610-04 10,0 cm, 4"



Fig. 1

10-610-02



Fig. 2

10-610-03



Fig. 3

10-610-04



Hohlsonden
 Directors
 Sondas acanaladas
 Sonde scanalate

- 10-610-11** 11,5 cm, 4 1/2"
- 10-610-13** 13,0 cm, 5 1/8"
- 10-610-14** 14,5 cm, 5 3/4"
- 10-610-16** 16,0 cm, 6 1/4"
- 10-610-18** 18,0 cm, 7"
- 10-610-20** 20,0 cm, 8"



Hohlsonden
 Directors
 Sondas acanaladas
 Sonde scanalate

- 10-612-11** 11,5 cm, 4 1/2"
- 10-612-13** 13,0 cm, 5 1/8"
- 10-612-14** 14,5 cm, 5 3/4"
- 10-612-16** 16,0 cm, 6 1/4"
- 10-612-18** 18,0 cm, 7"



Hohlsonde
 Director
 Sondas acanaladas
 Sonde scanalate

DOYEN

10-613-14 14,5 cm, 5 3/4"



Hohlsonde
 Director
 Sondas acanaladas
 Sonde scanalate

NÉLATON

10-615-16 16,0 cm, 6 1/4"



Hohlsonde
Director
Sondas acanaladas
Sonde scanalate

BRODIE

10-616-20 20,0 cm, 8 "



Fig. 1

10-617-01



Fig. 2

10-617-02



Fig. 3

10-617-03

PRATT

10-617-01 - 10-617-03 21,0 cm, 8 ¼ "



10-618-16



10-619-16



10-621-16



10-623-16



LOCKHART-MUMMERY

10-618-16 - 10-623-16 16,0 cm, 6 ¼ "



dreikant gerieft
triangular serrated
estriadura triangular
zigrinatura triangolare

FARRELL

10-630-12	Ø 0,9 x 12,0 cm
10-630-14	Ø 0,9 x 14,0 cm
10-630-16	Ø 1,1 x 16,0 cm
10-630-18	Ø 1,2 x 18,0 cm



spiralförmig gerieft
spirally serrated
estriadura espiral
zigrinatura spiraliforme

FARRELL

10-631-12	Ø 0,9 x 12,0 cm
10-631-14	Ø 0,9 x 14,0 cm
10-631-16	Ø 1,1 x 16,0 cm
10-631-18	Ø 1,2 x 18,0 cm



spiralförmig gerieft
spirally serrated
estriadura espiral
zigrinatura spiraliforme

MARTIN

10-632-12	Ø 1,2 x 12,0 cm
10-632-14	Ø 1,2 x 14,0 cm
10-632-16	Ø 1,2 x 16,0 cm
10-632-22	Ø 1,5 x 12,0 cm
10-632-24	Ø 1,5 x 14,0 cm
10-632-26	Ø 1,5 x 16,0 cm
10-632-28	Ø 1,5 x 18,0 cm



dreikant gerieft
triangular serrated
estriadura triangular
zigrinatura triangolare

MARTIN

10-633-12	Ø 1,5 x 12,0 cm
10-633-14	Ø 1,5 x 14,0 cm
10-633-16	Ø 1,5 x 16,0 cm
10-633-18	Ø 1,5 x 18,0 cm



gerieft
serrated
estriadura
zigrinatura

JOBSON-HORNE

10-634-14	Ø 1,5 x 14,0 cm
10-636-18	Ø 1,5 x 18,0 cm



spiralförmig gerieft
spirally serrated
estriadura espiral
zigrinatura spiraliforme

UCKERMANN

10-638-15	Ø 1,2 x 15,0 cm
------------------	-----------------

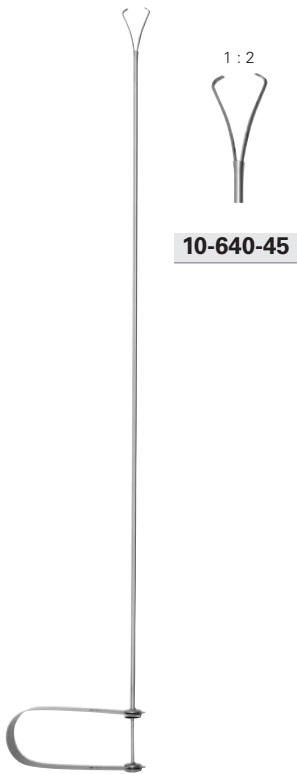

10-640-45

10-640-45 45,0 cm, 18 "

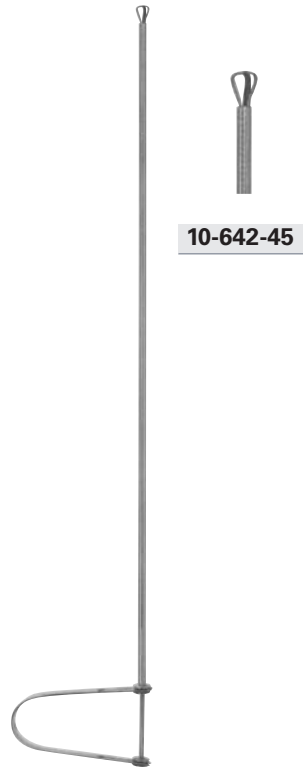

10-642-45

10-642-45 45,0 cm, 18 "

EDER



Pflasterspatel
Plaster spatula
Espátulas para emplasto
Spatole per impiastro

10-646-13 13,0 cm, 5 1/8 "
10-646-14 14,5 cm, 5 3/4 "

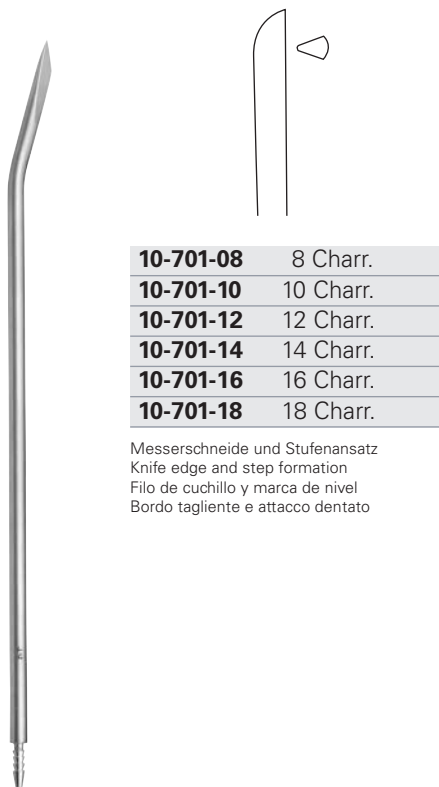

10-701-08	8 Charr.
10-701-10	10 Charr.
10-701-12	12 Charr.
10-701-14	14 Charr.
10-701-16	16 Charr.
10-701-18	18 Charr.

Messerschneide und Stufenansatz
Knife edge and step formation
Filo de cuchillo y marca de nivel
Bordo tagliente e attacco dentato

REDON

10-701-08 - 10-701-18 19,5 cm, 7 3/4 "

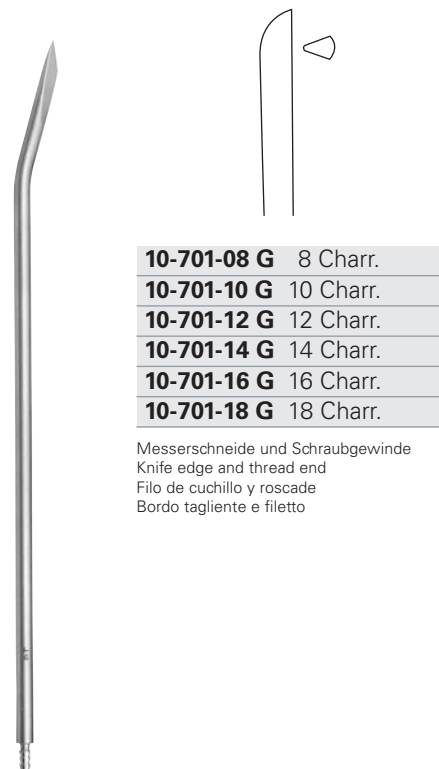

10-701-08 G	8 Charr.
10-701-10 G	10 Charr.
10-701-12 G	12 Charr.
10-701-14 G	14 Charr.
10-701-16 G	16 Charr.
10-701-18 G	18 Charr.

Messerschneide und Schraubgewinde
Knife edge and thread end
Filo de cuchillo y roscade
Bordo tagliente e filetto

REDON

10-701-08 G - 10-701-18 G 19,5 cm, 7 3/4 "



10-705-08	8 Charr.
10-705-10	10 Charr.
10-705-12	12 Charr.
10-705-14	14 Charr.
10-705-16	16 Charr.
10-705-18	18 Charr.

Messerschneide und Stufenansatz
Knife edge and step formation
Filo de cuchillo y marca de nivel
Bordo tagliente e attacco dentato

REDON

10-705-08 - 10-705-18 16,0 cm, 6 ¼"



10-705-08 G	8 Charr.
10-705-10 G	10 Charr.
10-705-12 G	12 Charr.
10-705-14 G	14 Charr.
10-705-16 G	16 Charr.
10-705-18 G	18 Charr.

Messerschneide und Schraubgewinde
Knife edge and thread end
Filo de cuchillo y roscade
Bordo tagliente e filetto

REDON

10-705-08 G - 10-705-18 G 16,0 cm, 6 ¼"



10-706-08	8 Charr.
10-706-10	10 Charr.
10-706-12	12 Charr.
10-706-14	14 Charr.
10-706-16	16 Charr.
10-706-18	18 Charr.

Dreikantspitze und Stufenansatz
Triangular tip and step formation
Punta triangular y marca de nivel
Punta triangolare e attacco dentato

REDON

10-706-08 - 10-706-18 19,5 cm, 7 ¾"



10-706-08 G	8 Charr.
10-706-10 G	10 Charr.
10-706-12 G	12 Charr.
10-706-14 G	14 Charr.
10-706-16 G	16 Charr.
10-706-18 G	18 Charr.

Dreikantspitze und Schraubgewinde
Triangular tip and thread end
Punta triangular y roscade
Punta triangolare e filetto

REDON

10-706-08 G - 10-706-18 G 19,5 cm, 7 ¾"



10-704-08	8 Charr.
10-704-10	10 Charr.
10-704-12	12 Charr.
10-704-14	14 Charr.
10-704-16	16 Charr.
10-704-18	18 Charr.

Dreikantsspitze und Stufenansatz
Triangular tip and step formation
Punta triangular y marca de nivel
Punta triangolare e attacco dentato

REDON

10-704-08 - 10-704-18 16,0 cm, 6 ¼"



10-704-08 G	8 Charr.
10-704-10 G	10 Charr.
10-704-12 G	12 Charr.
10-704-14 G	14 Charr.
10-704-16 G	16 Charr.
10-704-18 G	18 Charr.

Dreikantsspitze und Schraubgewinde
Triangular tip and thread end
Punta triangular y roscade
Punta triangolare e filetto

REDON

10-704-08 G - 10-704-18 G 16,0 cm, 6 ¼"

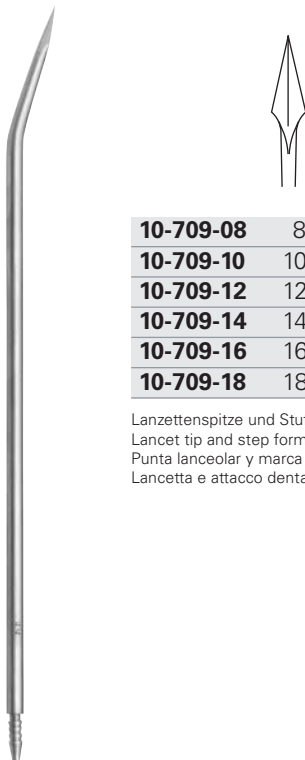

10-709-08	8 Charr.
10-709-10	10 Charr.
10-709-12	12 Charr.
10-709-14	14 Charr.
10-709-16	16 Charr.
10-709-18	18 Charr.

Lanzettenspitze und Stufenansatz
Lancet tip and step formation
Punta lanceolar y marca de nivel
Lancetta e attacco dentato

REDON

10-709-08 - 10-709-18 19,5 cm, 7 ¾"

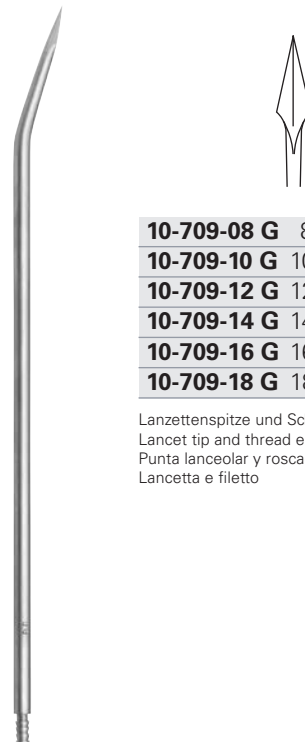

10-709-08 G	8 Charr.
10-709-10 G	10 Charr.
10-709-12 G	12 Charr.
10-709-14 G	14 Charr.
10-709-16 G	16 Charr.
10-709-18 G	18 Charr.

Lanzettenspitze und Schraubgewinde
Lancet tip and thread end
Punta lanceolar y roscade
Lancetta e filetto

REDON

10-709-08 G - 10-709-18 G 19,5 cm, 7 ¾"

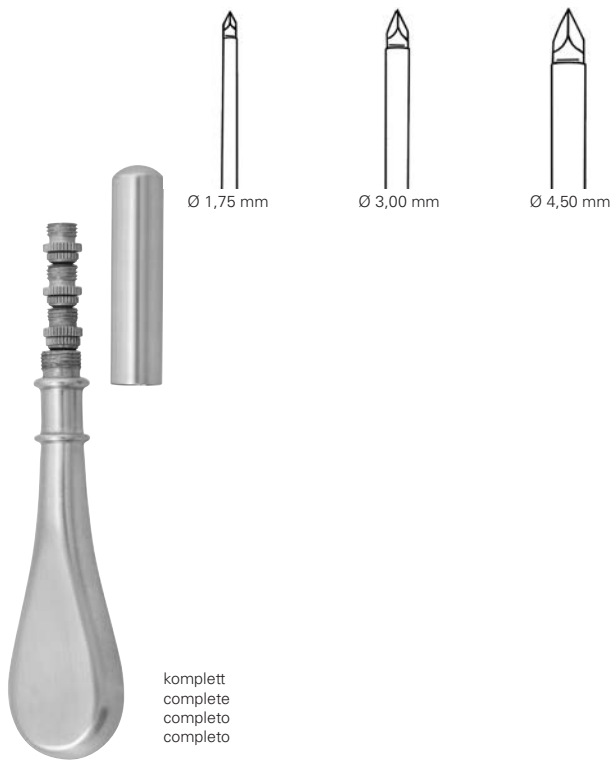

UNIVERSAL

10-720-03 14,0 cm, 5 ½"

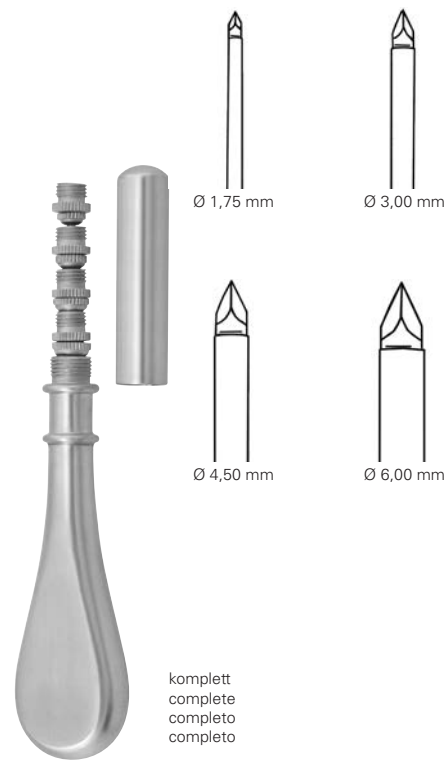

UNIVERSAL

10-720-04 14,0 cm, 5 ½"

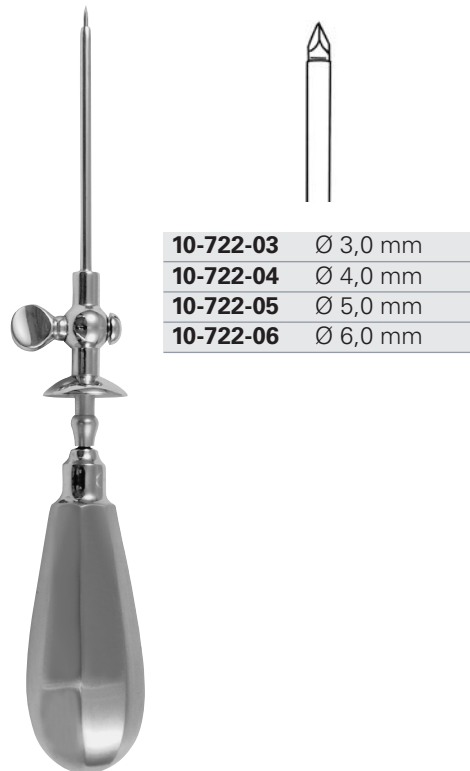

STANDARD

10-722-03 - 10-722-06 12,0 cm, 4 ¾"

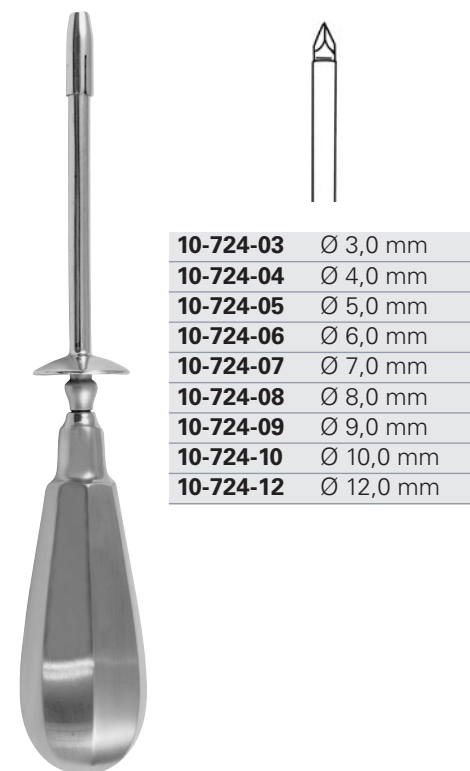

NELSON

10-724-03 - 10-724-12 21,0 cm, 8 ¼"



Ø 4,5 mm
10-726-04

CARSTENS

10-726-04 Ø 4,5 mm

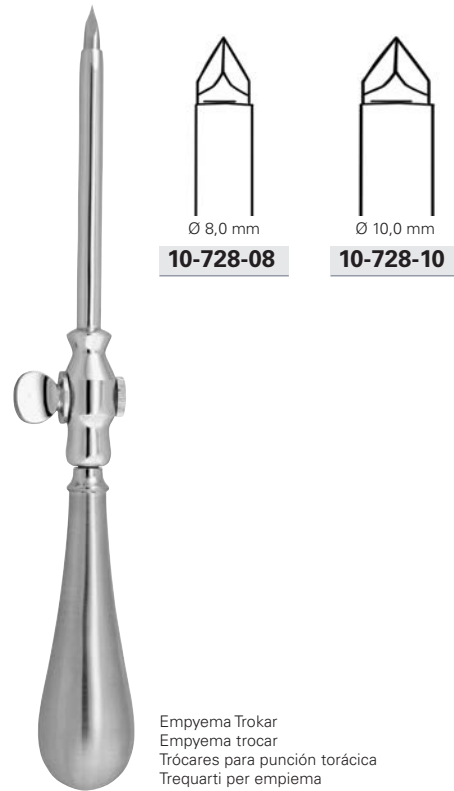

Ø 8,0 mm
10-728-08

Ø 10,0 mm
10-728-10

Empyema Trokar
Empyema trocar
Trócares para punción torácica
Trequarti per empiema

BUELAU

10-728-08 - 10-728-10 21,0 cm, 9 ½"



10-730-18 Ø 1,75 mm
10-730-20 Ø 2,00 mm
10-730-23 Ø 2,30 mm
10-730-24 Ø 2,70 mm

Kieferhöhlentroker
Antrum trocar
Cánula para punción del seno maxilar
Trequarti per puntura del seno mascellare

LICHTWITZ

10-730-18 - 10-730-24 18,5 cm, 7 ¼"

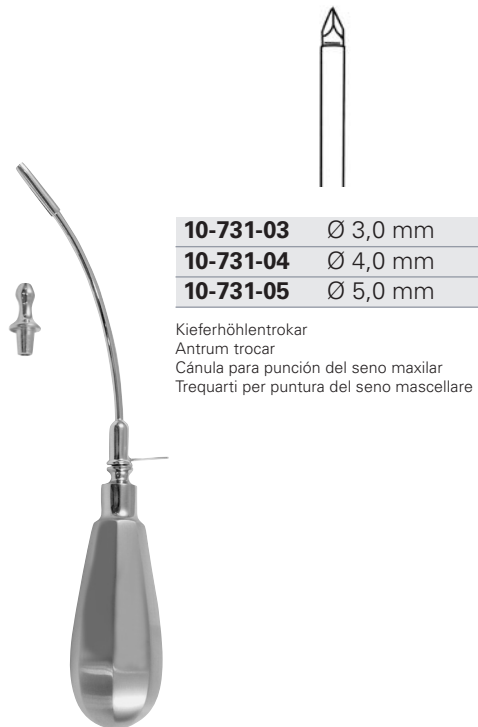

10-731-03 Ø 3,0 mm
10-731-04 Ø 4,0 mm
10-731-05 Ø 5,0 mm

Kieferhöhlentroker
Antrum trocar
Cánula para punción del seno maxilar
Trequarti per puntura del seno mascellare

PIERCE

10-731-03 - 10-731-05 15,0 cm, 6"

Kieferhöhlentrokar
Antrum trocar
Cánula para punción del seno maxilar
Trequarti per puntura del seno mascellare
Ø 4,0 mm



KRAUSE

10-733-04 16,0 cm, 6 ¼"

Ø 5,5 mm

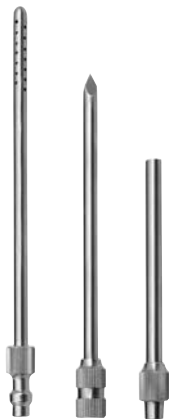

DUKE

10-734-05 11,0 cm, 4 ½"



10-736-40	Ø 4,0 mm
10-736-46	Ø 4,6 mm
10-736-53	Ø 5,3 mm
10-736-60	Ø 6,0 mm

Gallenblasentroker
Gall bladder trocar
Trócares para vesícula biliar
Trequarti per vesicia biliare



OCHSNER

10-736-40 - 10-736-60 15,0 cm, 6"



Ø 2,0 mm
10-738-02



LANDAU

10-738-02 Ø 2,0 mm



Ø 3,0 mm
10-739-03

Kieferhöhlentrokar
Antrum trocar
Cánula para punción del seno maxilar
Trequarti per puntura del seno mascellare



DOUGLAS

10-739-03 14,0 cm, 5 ½"



Ø 3,0 mm
10-741-03

Kieferhöhlentrokar
Antrum trocar
Cánula para punción del seno maxilar
Trequarti per puntura del seno mascellare



COAKLEY

10-741-03 15,5 cm, 6"

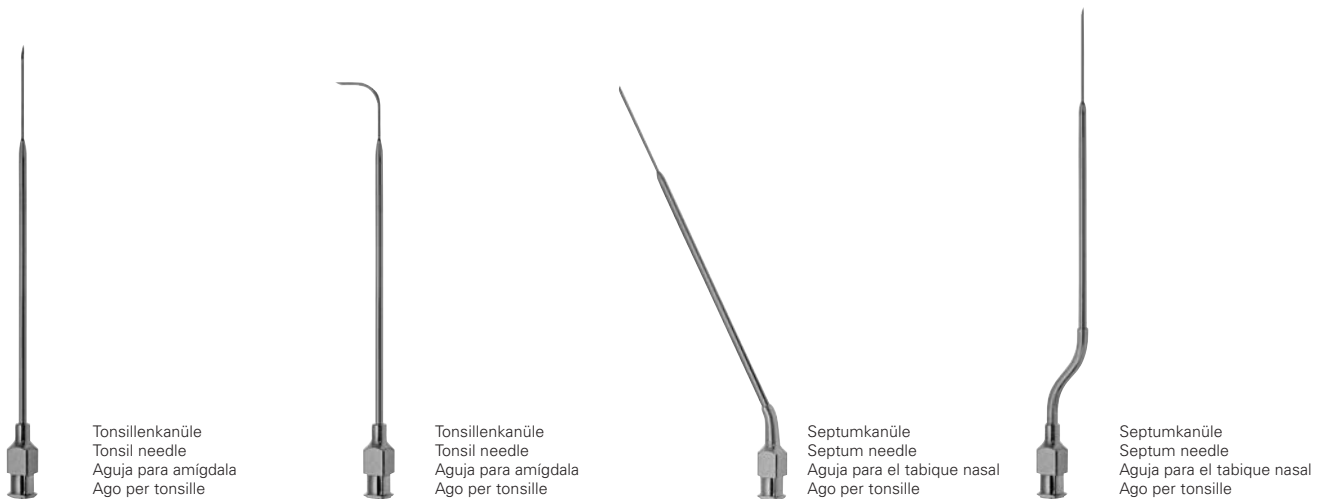
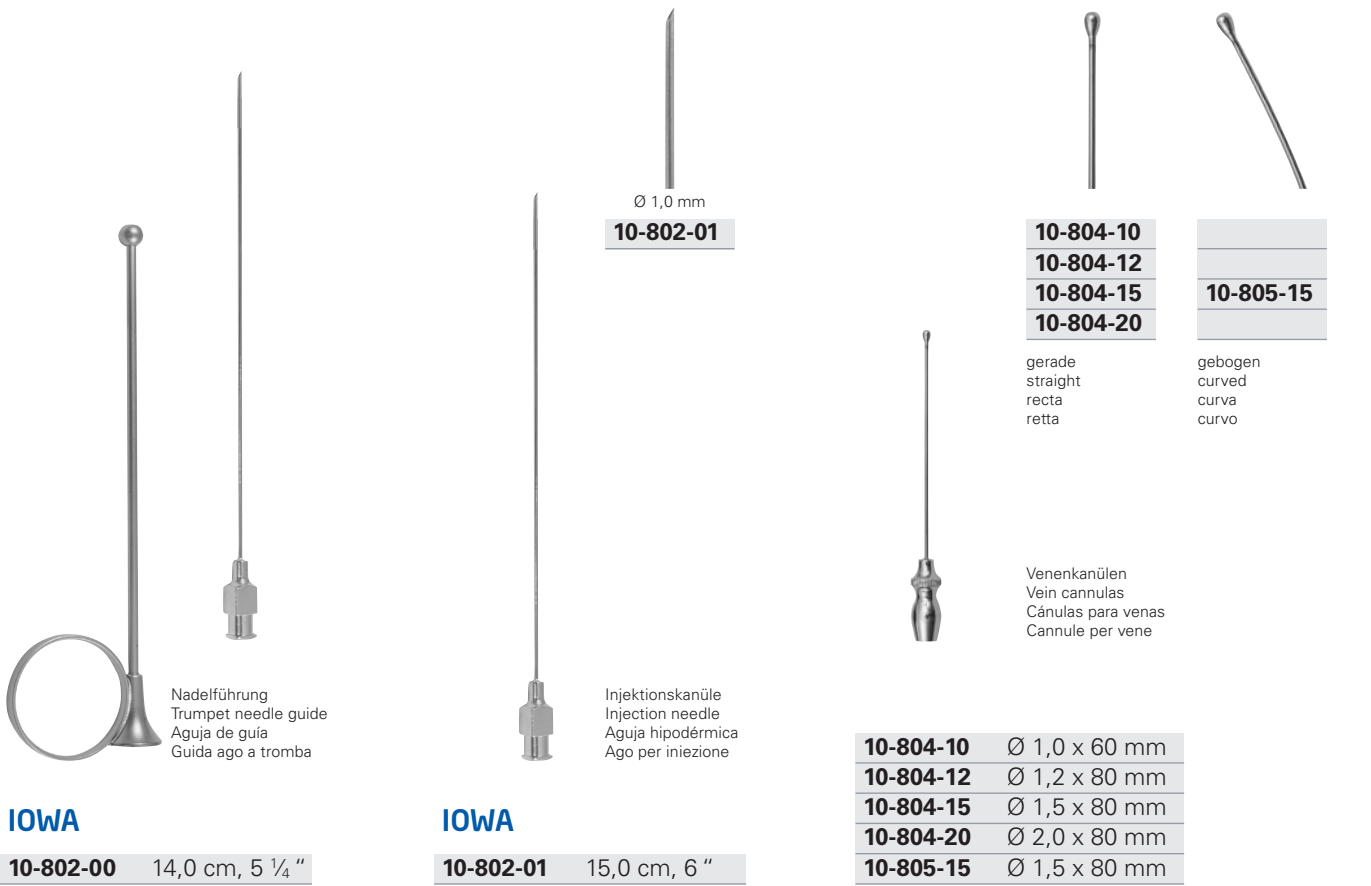

10-810-01 Ø 0,8 x 100 mm **10-810-02** Ø 0,8 x 80 mm **10-810-03** Ø 0,8 x 107 mm **10-810-04** Ø 0,8 x 140 mm



Insufflationskanülen
Inflation cannulas
Cánulas para insuflación
Cannula per insufflazione

VERRES

10-812-08	Ø 2,0 x 80 mm
10-812-10	Ø 2,0 x 100 mm
10-812-12	Ø 2,0 x 120 mm
10-812-15	Ø 2,0 x 150 mm
10-812-17	Ø 2,0 x 170 mm
10-812-20	Ø 2,0 x 200 mm

Kanüle zur Sternalpunktion
Sternum puncture needle
Agujas para punción del esternón
Aghi per la puntura dello sterno



KLIMA-ROSEGGER

10-815-18	Ø 1,8 x 35 mm
------------------	---------------

Gefäß Spülkanülen
Vessel irrigation cannulas
Cánulas para irrigación vascular
Cannula per irrigazione vascolare



VOLLMAR

10-817-15	Ø 1,5 x 60 mm
10-817-20	Ø 2,0 x 60 mm
10-817-25	Ø 2,5 x 60 mm
10-817-30	Ø 3,0 x 60 mm
10-817-40	Ø 4,0 x 60 mm

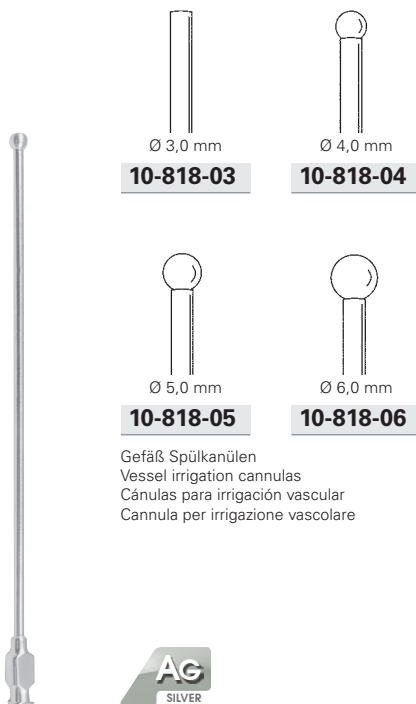

Ø 3,0 mm
10-818-03

Ø 4,0 mm
10-818-04

Ø 5,0 mm
10-818-05

Ø 6,0 mm
10-818-06

Gefäß Spülkanülen
Vessel irrigation cannulas
Cánulas para irrigación vascular
Cannula per irrigazione vascolare



SCHMID

10-818-03 - 10818-06	15,0 cm, 5 7/8 "
-----------------------------	------------------



Ø 3,0 mm
10-820-05

Heparinnadel
Heparin flushing needle
Aguja para heparin
Ago per eparina

MOCK

10-820-05	4,5 cm, 1 3/4 "
------------------	-----------------



Ø 3,0 mm
10-820-06

Heparinnadel
Heparin flushing needle
Aguja para heparin
Ago per eparina

MOCK

10-820-06	6,0 cm, 2 1/2 "
------------------	-----------------

Kanülen für die Leberblindpunktion
Liver blind puncture needles
Agujas para la punción ciega del hígado
Aghi per la puntura cieca del fegato



MENGHINI

10-822-10	Ø 1,0 x 35 mm
10-822-15	Ø 1,0 x 70 mm
10-822-20	Ø 1,2 x 70 mm
10-822-25	Ø 1,2 x 100 mm
10-822-30	Ø 1,4 x 70 mm
10-822-35	Ø 1,4 x 100 mm
10-822-40	Ø 1,6 x 70 mm
10-822-50	Ø 1,8 x 100 mm

Kanülen zur gezielten Leberpunktion
Needles for controlled liver puncture
Agujas para la punción del hígado baja el control laparoscópico
Aghi per la puntura controllata del fegato



MENGHINI

10-824-14	Ø 1,4 x 168 mm
10-824-18	Ø 1,8 x 168 mm

Kanülen für die Lumbalpunktion
Lumbar puncture needles
Agujas para punción lumbar
Aghi per punture lombari



QUINKE

10-828-01	Ø 0,7 x 76 mm
10-828-02	Ø 0,7 x 89 mm
10-828-03	Ø 1,0 x 76 mm
10-828-04	Ø 1,0 x 89 mm
10-828-05	Ø 1,2 x 76 mm
10-828-06	Ø 1,2 x 89 mm



LUER

10-840-01	1,0 ml
10-840-02	2,0 ml
10-840-05	5,0 ml
10-840-10	10,0 ml
10-840-20	20,0 ml
10-840-50	50,0 ml



LUER-LOCK

10-844-01	1,0 ml
10-844-02	2,0 ml
10-844-05	5,0 ml
10-844-10	10,0 ml
10-844-20	20,0 ml
10-844-50	50,0 ml



LUER-LOCK

10-848-02	2,0 ml
10-848-05	5,0 ml
10-848-10	10,0 ml
10-848-20	20,0 ml

Zylinder für 10-848-02 - 10-848-20
Barrels for 10-848-02 - 10-848-20
Cilindros para 10-848-02 - 10-848-20
Cilindri per 10-848-02 - 10-848-20



LUER-LOCK

10-849-02	2,0 ml
10-849-05	5,0 ml
10-849-10	10,0 ml
10-849-20	20,0 ml

Luftbläser, komplett
Air blower, complete
Jeringas para aire, completo
Siringhe per aria, completo



10-850-00

Luftbläser
Air blower
Jeringas para aire
Siringhe per aria



10-850-02

Kanüle
Needle
Aguja
Aghi



10-850-01



Wund- und Blasenspritzen mit 1 konischen und 1 olivenförmigen Ansatz
Wound and bladder syringes with 1 conical and 1 bulbous tip
Jeringas para enjuagar la vejiga y heridas con 1 punta cónica y 1 punta forma oliva
Siringhe per ferite e vescica con 1 punta conica e 1 punta oliva

JANET

10-860-05	50,0 ml
10-860-10	100,0 ml
10-860-15	150,0 ml
10-860-20	200,0 ml



Wund- und Blasenspritzen mit 1 konischen und 1 olivenförmigen Ansatz
Wound and bladder syringes with 1 conical and 1 bulbous tip
Jeringas para enjuagar la vejiga y heridas con 1 punta cónica y 1 punta forma oliva
Siringhe per ferite e vescica con 1 punta conica e 1 punta oliva

JANET-G

10-863-05	50,0 ml
10-863-10	100,0 ml
10-863-15	150,0 ml
10-863-20	200,0 ml

Zylinder für 10-860-05 - 10-860-20
Barrels for 10-860-05 - 10-860-20
Cilindros para 10-860-05 - 10-860-20
Cilindri per 10-860-05 - 10-860-20



JANET

10-862-05	50,0 ml
10-862-10	100,0 ml
10-862-15	150,0 ml
10-862-20	200,0 ml



Wund- und Blasenspritzen mit 1 konischen und 1 olivenförmigen Ansatz
Wound and bladder syringes with 1 conical and 1 bulbous tip
Jeringas para enjuagar la vejiga y heridas con 1 punta cónica y 1 punta forma oliva
Siringhe per ferite e vescica con 1 punta conica e 1 punta oliva

Zylinder für 10-864-05 - 10-864-25
Barrels for 10-864-05 - 10-864-25
Cilindros para 10-864-05 - 10-864-25
Cilindri per 10-864-05 - 10-864-25

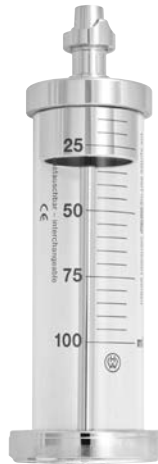

JANET-GS

10-864-05	50,0 ml
10-864-07	75,0 ml
10-864-10	100,0 ml
10-864-15	150,0 ml
10-864-20	200,0 ml
10-864-25	250,0 ml

JANET-GS

10-866-05	50,0 ml
10-866-07	75,0 ml
10-866-10	100,0 ml
10-866-15	150,0 ml
10-866-20	200,0 ml
10-866-25	250,0 ml



Ansatz
Tip
Punta
Punta

JANET-GS

10-864-99

Kehlkopf-Spritzen mit Kanüle 10-871-99
Laryngeal Syringes with cannula 10-871-99
Jeringa de laringeos con aguja 10-871-99
Siringa per laringei con aghi 10-871-99

Kehlkopf- Kanüle
Laryngeal cannula
Aguja para laringeos
Aghi per laringei



LUER-LOCK

10-871-02	2,0 ml
10-871-05	5,0 ml
10-871-10	10,0 ml

LUER-LOCK

10-871-99



Mikro Absaugrohr komplett, bestehend aus:
Micro suction tube complete, consisting of:
Aspirador micro, completo, compuesto de:
Micro tubo aspirazione, completo, composta da:
10-900-01 | 10-900-04 - 10-900-08



WULLSTEIN

10-900-00 14,0 cm, 5 1/2"

WULLSTEIN

10-900-01 14,0 cm, 5 1/2"

WULLSTEIN

10-900-04 Ø 0,4 mm

10-900-06 Ø 0,6 mm

10-900-08 Ø 0,8 mm

graduirt
graduated
graduado
graduato

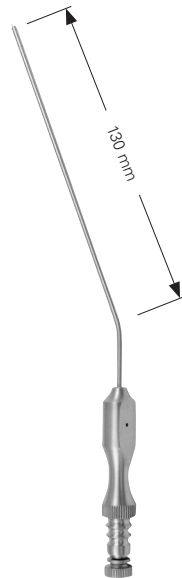
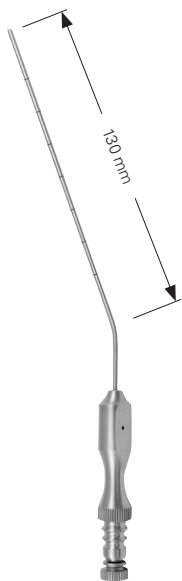

FRAZIER

10-901-05 5 Charr.

10-901-07 7 Charr.

10-901-09 9 Charr.

FRAZIER

10-902-06 6 Charr.

10-902-07 7 Charr.

10-902-08 8 Charr.

10-902-09 9 Charr.

10-902-10 10 Charr.

10-902-11 11 Charr.

10-902-12 12 Charr.

10-902-15 15 Charr.

PLESTER

10-903-05 5 Charr.

10-903-06 6 Charr.

10-903-07 7 Charr.

10-903-08 8 Charr.

10-903-09 9 Charr.

10-903-10 10 Charr.

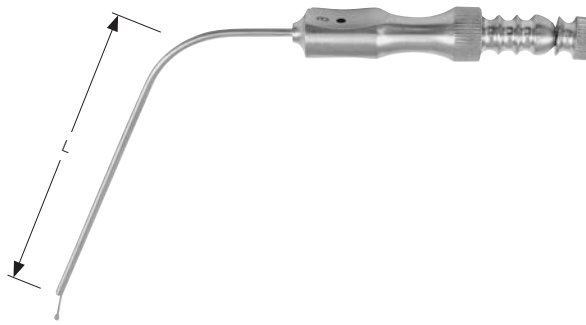

FERGUSSON 90°

Ø	Länge 110 mm Length 110 mm Longitud 110 mm Lunghezza 110 mm	Länge 130 mm Length 130 mm Longitud 130 mm Lunghezza 130 mm	Länge 160 mm Length 160 mm Longitud 160 mm Lunghezza 160 mm	Länge 200 mm Length 200 mm Longitud 200 mm Lunghezza 200 mm
4 Charr.	10-904-04			
5 Charr.	10-904-05	10-904-25	10-904-45	10-904-65
6 Charr.	10-904-06	10-904-26	10-904-46	10-904-66
7 Charr.	10-904-07			
8 Charr.	10-904-08	10-904-28	10-904-48	10-904-68
9 Charr.	10-904-09	10-904-29	10-904-49	10-904-69
10 Charr.	10-904-10			
11 Charr.	10-904-11			
12 Charr.	10-904-12	10-904-32	10-904-52	10-904-72
15 Charr.	10-904-15	10-904-35	10-904-55	10-904-75

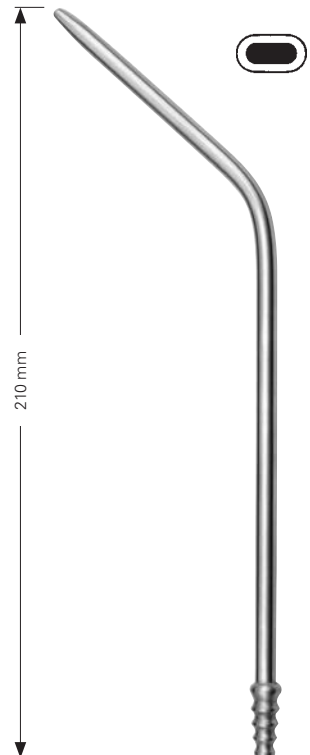
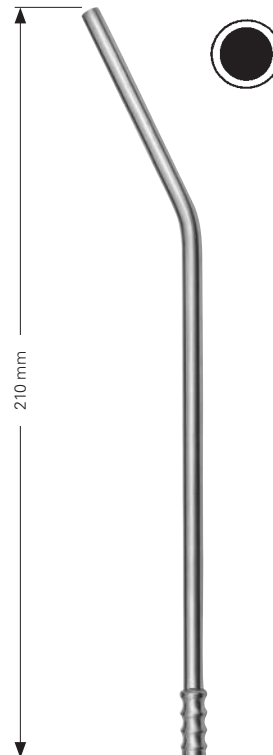

ADSON

10-905-04	Ø 4,0 mm
10-905-05	Ø 5,0 mm

NUBOER

10-906-05	Ø 5,0 mm
10-906-06	Ø 6,0 mm

NUBOER

10-906-07	Ø 6,0 mm
------------------	----------

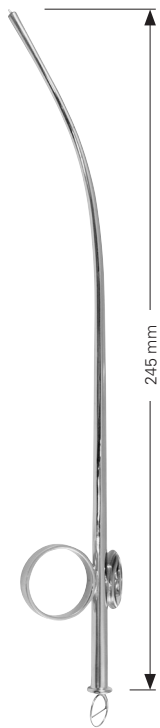

MAGILL

10-906-30	Ø 3,0 mm
10-906-35	Ø 3,5 mm
10-906-40	Ø 4,0 mm



Reinigungsdraht
Stilette
Alambre de limpieza
Filo per la pulitura

MAGILL

10-906-99

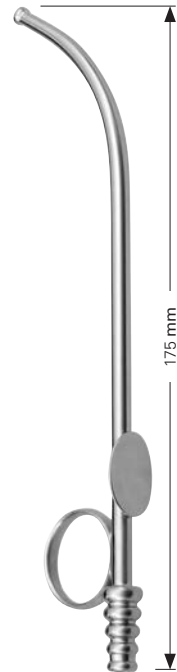

10-906-55 Ø 5,5 mm



isoliert
insulated
aislada
isolato

FERGUSON 85°

10-907-00 Ø 4,0 mm



FERGUSON 85°

10-907-01	6 Charr.
10-907-02	8 Charr.
10-907-03	9 Charr.
10-907-04	10 Charr.
10-907-05	12 Charr.
10-907-06	15 Charr.

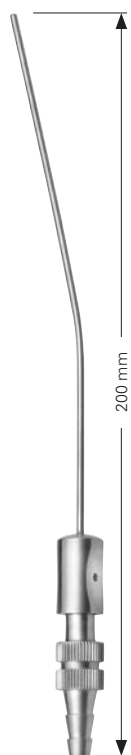

LEMPERT

10-908-07	Ø 2,0 mm
10-908-09	Ø 3,0 mm

Hirnventrikelpunktionskanülen
Ventricel of cerebrum puncture cannulas
Cánulas para la punción del ventriculo cerebral
Cannule per la puntura del ventricolo cerebrale



FRAZIER

10-908-25	Ø 2,5 mm
10-908-30	Ø 3,0 mm

Hirnventrikelpunktionskanülen
Ventricel of cerebrum puncture cannulas
Cánulas para la punción del ventriculo cerebral
Cannule per la puntura del ventricolo cerebrale



10-909-20	Ø 2,0 mm
10-909-25	Ø 2,5 mm

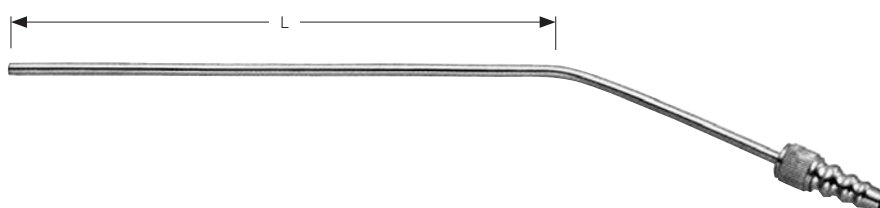

YASARGIL

Ø	Länge 130 mm Length 130 mm Longitud 130 mm Lunghezza 130 mm	Länge 150 mm Length 150 mm Longitud 150 mm Lunghezza 150 mm	Länge 180 mm Length 180 mm Longitud 180 mm Lunghezza 180 mm	Länge 220 mm Length 220 mm Longitud 220 mm Lunghezza 220 mm
Ø 1,5 mm	10-910-15	10-910-16	10-910-17	10-910-18
Ø 2,0 mm	10-910-20	10-910-21	10-910-22	10-910-23
Ø 2,5 mm	10-910-24	10-910-25	10-910-26	10-910-27
Ø 3,5 mm	10-910-33	10-910-35	10-910-36	10-910-37
Ø 4,5 mm			10-910-45	



YANKAUER

10-911-01 27,0 cm, 10 3/4 "



YANKAUER

10-911-02 27,0 cm, 10 3/4 "



Olive
Olive
Oliva
Oliva

YANKAUER

10-911-31



BABY-YANKAUER

10-911-03 21,0 cm, 8 1/4 "



Olive
Olive
Oliva
Oliva

BABY-YANKAUER

10-911-32



mit Absperrventil und
abschraubbarem Rohr
with stopcock and tube
to be screwed off
con interruptor y tubo
desenroscable
con interruttore e tubo
svitabile

WALTON-YANKAUER

10-911-04 33,0 cm, 13 "

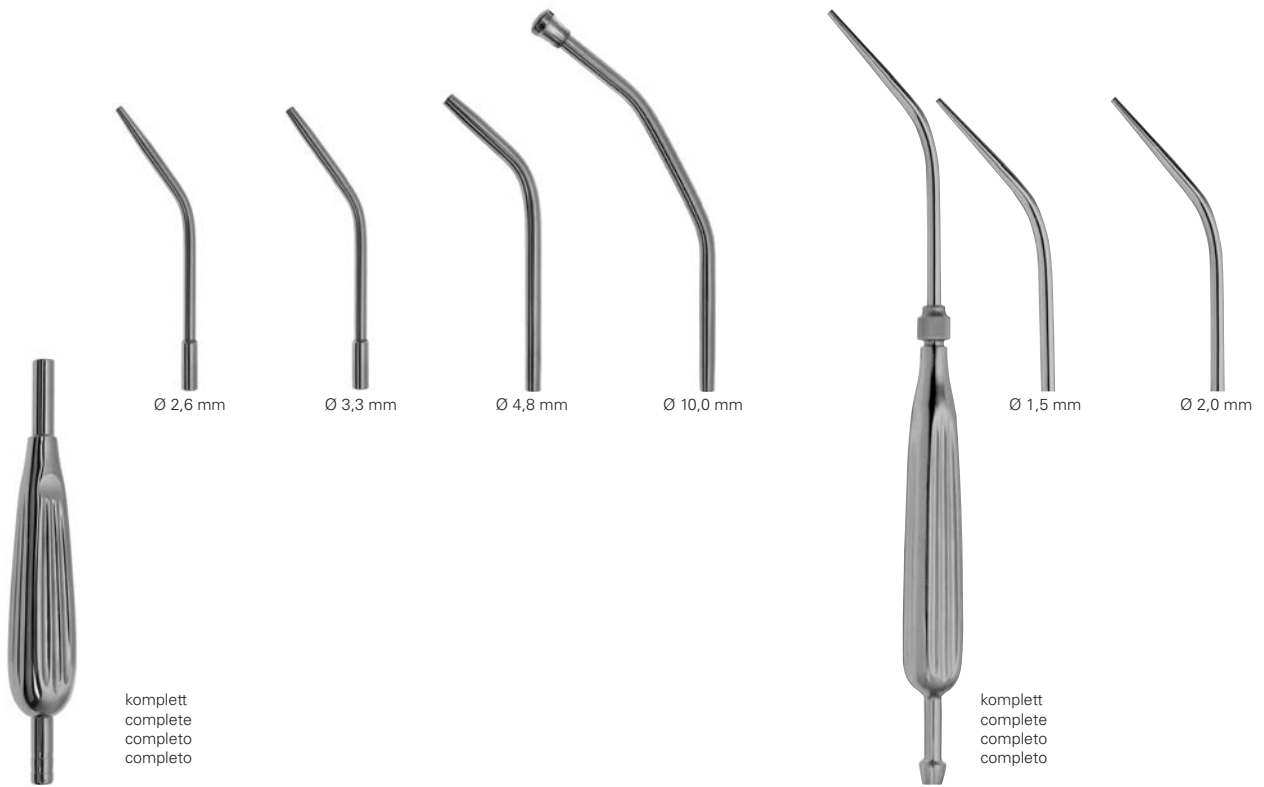

komplett
complete
completo
completo

komplett
complete
completo
completo

YANKAUER

10-912-00 27,0 cm, 10 3/4"

COUPLAND

10-913-00 26,0 cm, 10 1/4"



COUPLAND

10-913-01 17,0 cm, 6 3/4"



COUPLAND

10-913-15 - 10-913-35 10,0 cm, 4"

Ø 1,5 mm
10-913-15

Ø 2,0 mm
10-913-20

Ø 2,5 mm
10-913-25

Ø 3,5 mm
10-913-35

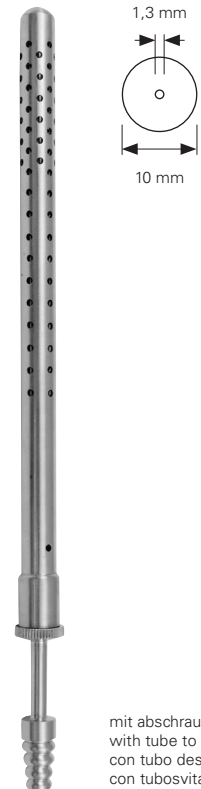

mit abschraubbarem Rohr
with tube to be screwed off
con tubo desenroscable
con tubosvitabile

POOLE

10-914-10 22,0 cm, 8 5/8"

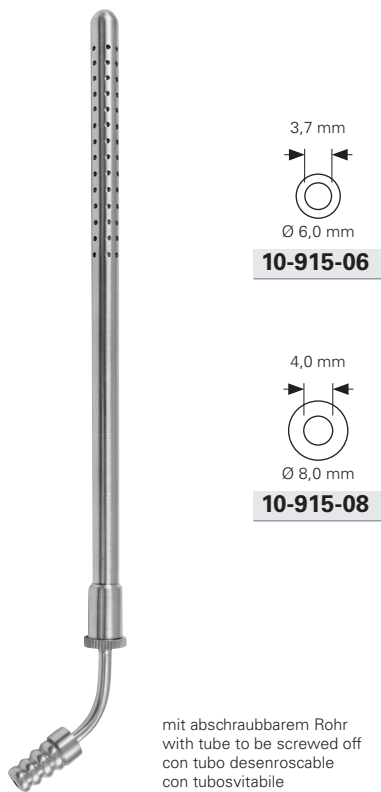

POOLE

10-915-06 - 10-915-08 22,0 cm, 8 5/8 "



COOLEY

10-917-08 35,0 cm, 13 3/4 "



COOLEY

10-919-10 31,0 cm, 12 1/4 "



COOLEY

10-921-07 30,0 cm, 11 3/4 "



COOLEY

10-923-08 33,0 cm, 13 "

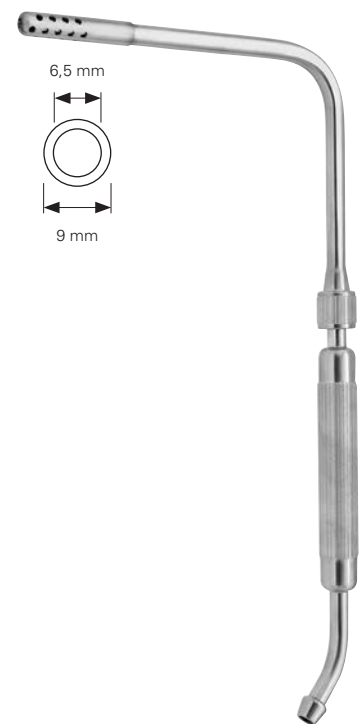

COOLEY

10-925-09 25,0 cm, 9 3/4 "



DE BAKEY

10-931-16 16,0 cm, 6 1/4"



DE BAKEY

10-931-27 27,0 cm, 10 3/4"



DE BAKEY

10-935-27 27,0 cm, 10 3/4"



FINSTERER

10-937-32 32,0 cm, 12 1/2"

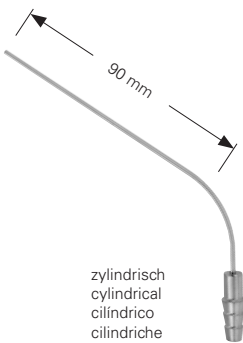

zylindrisch
cylindrical
cilindrico
cilindriche

10-940-10 Ø 1,0 mm
10-940-15 Ø 1,5 mm
10-940-20 Ø 2,0 mm

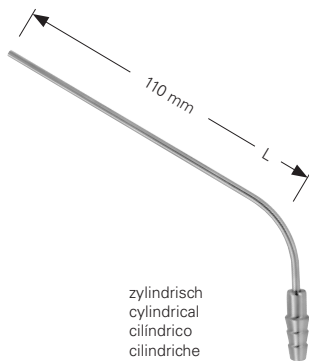

zylindrisch
cylindrical
cilindrico
cilindriche

10-940-25 Ø 2,5 mm
10-941-30 Ø 3,0 mm
10-941-40 Ø 4,0 mm
10-941-50 Ø 5,0 mm

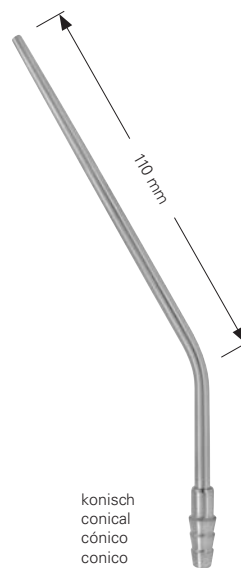

konisch
conical
cónico
conico

10-942-03 Ø 3,0 mm
10-942-04 Ø 3,5 mm

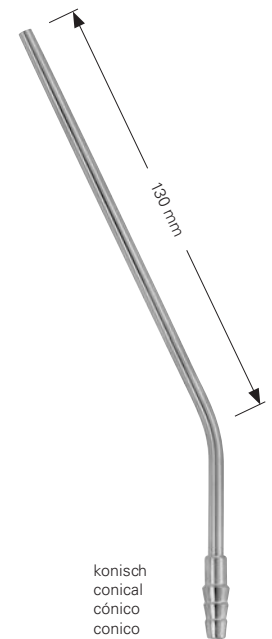

konisch
conical
cónico
conico

10-942-05 Ø 4,5 mm

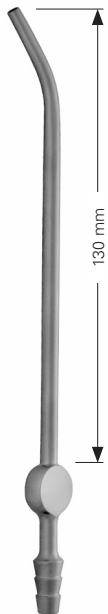

konisch
conical
cónico
conico

10-942-13 Ø 4,5 mm



konisch
conical
cónico
conico

10-942-18 Ø 3,0 mm

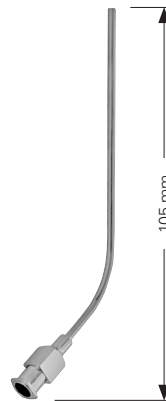

ROSEN

10-944-05	Ø 0,5 mm
10-944-06	Ø 0,6 mm
10-944-07	Ø 0,7 mm
10-944-08	Ø 0,8 mm
10-944-09	Ø 0,9 mm
10-944-10	Ø 1,0 mm
10-944-12	Ø 1,2 mm
10-944-14	Ø 1,4 mm
10-944-15	Ø 1,5 mm
10-944-18	Ø 1,8 mm
10-944-20	Ø 2,0 mm
10-944-22	Ø 2,2 mm
10-944-25	Ø 2,5 mm
10-944-30	Ø 3,0 mm



ROSEN

10-944-55	Ø 0,5 mm
10-944-56	Ø 0,6 mm
10-944-57	Ø 0,7 mm
10-944-58	Ø 0,8 mm
10-944-59	Ø 0,9 mm
10-944-60	Ø 1,0 mm
10-944-62	Ø 1,2 mm
10-944-64	Ø 1,4 mm
10-944-65	Ø 1,5 mm
10-944-68	Ø 1,8 mm
10-944-70	Ø 2,0 mm
10-944-72	Ø 2,2 mm
10-944-75	Ø 2,5 mm
10-944-80	Ø 3,0 mm

Saughandgriff mit Unterbrecher
Suction handle with finger cut off
Mango para aspiración y interrupter
Manico per aspirazione e interruttore



WULLSTEIN

10-944-00 11,0 cm, 4 3/8"

Saughandgriff mit Unterbrecher
Suction handle with finger cut off
Mango para aspiración y interrupter
Manico per aspirazione e interruttore



10-944-01 11,0 cm, 4 3/8"

Saughandgriff mit Unterbrecher
Suction handle with finger cut off
Mango para aspiración y interrupter
Manico per aspirazione e interruttore



10-944-02 6,0 cm, 2 3/8"

Saughandgriff mit Unterbrecher
Suction handle with finger cut off
Mango para aspiración y interrupter
Manico per aspirazione e interruttore



10-944-03 10,0 cm, 4"

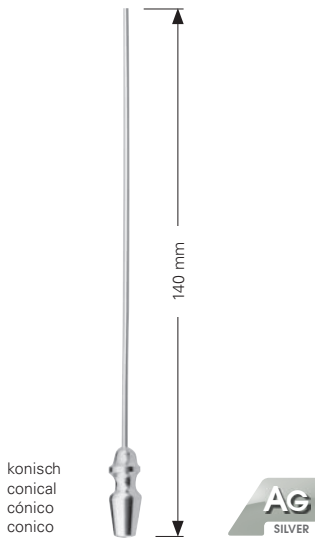

WULLSTEIN

10-946-01 Ø 1,5 mm

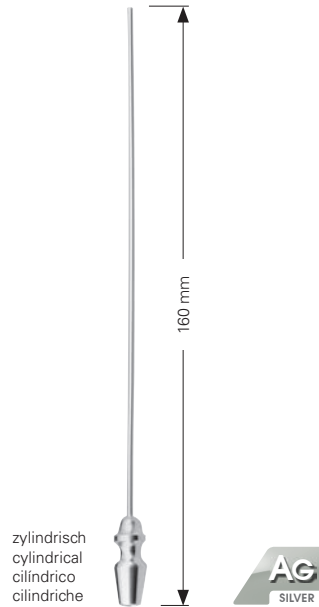

WULLSTEIN

10-946-02 Ø 1,5 mm

10-946-03 Ø 2,0 mm

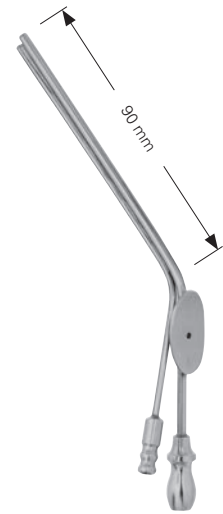

HOUSE

10-947-07 Ø 0,9 x 0,7 mm

10-947-09 Ø 1,2 x 0,9 mm

10-947-12 Ø 1,5 x 1,2 mm

10-947-18 Ø 1,8 x 1,8 mm

10-947-19 Ø 2,5 x 2,0 mm

10-947-20 Ø 3,0 x 2,0 mm

10-947-21 Ø 4,5 x 2,0 mm

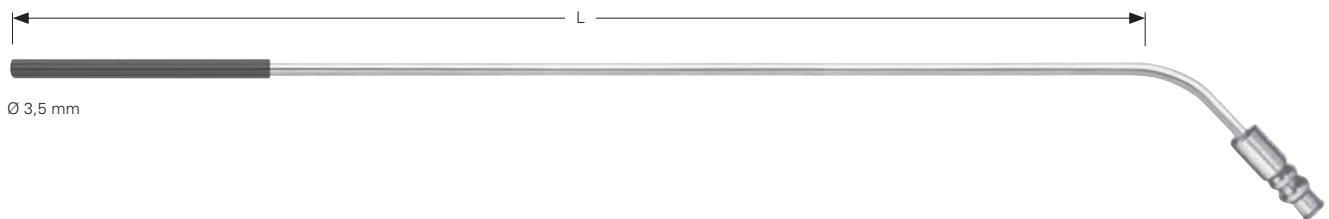

10-950-35 35,0 cm, 13 3/4"

10-950-50 50,0 cm, 19 1/2"

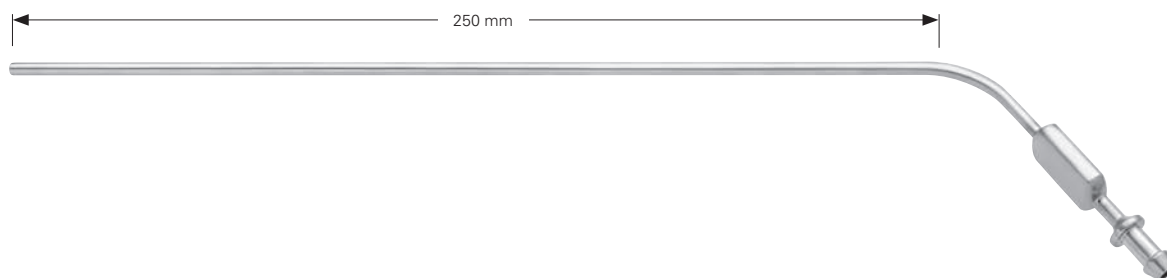

10-951-20 Ø 2,0 mm

10-951-25 Ø 2,5 mm

10-951-30 Ø 3,0 mm

Koagulations Saugrohr, isoliert
Coagulation suction tube, insulated
Tubo de aspiración y coagulación, aislado
Tubo per aspirazione coagulazione, isolato



10-953-10 10,0 cm, 4 "
10-953-26 26,0 cm, 10 1/4 "

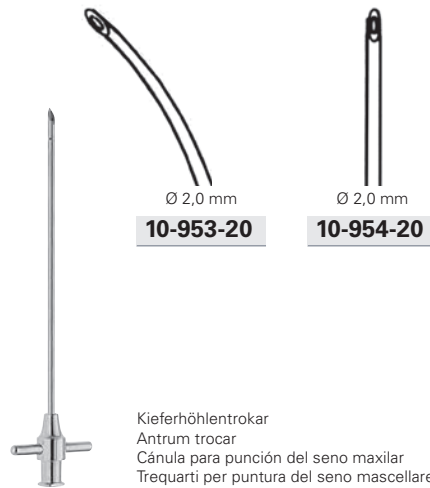

Kieferhöhlentrokar
Antrum trocar
Cánula para punción del seno maxilar
Trequarti per puntura del seno mascellare

RUSKIN

10-953-20 - 10-954-20 10,0 cm, 4 "



HAJEK

10-954-16 Ø 3,5 mm

Kieferhöhlentrokar
Antrum trocar
Cánula para punción del seno maxilar
Trequarti per puntura del seno mascellare

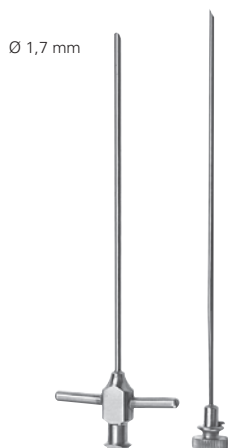

LICHTWITZ

10-955-00 11,0 cm, 4 3/8 "

Kieferhöhlenpunktionskanülen
Antrum trocar needles
Cánula para punción del seno maxilar
Trequarti per puntura del seno mascellare

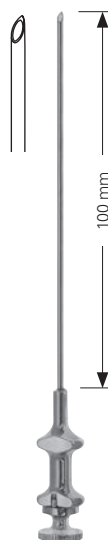

LICHTWITZ

10-955-15 Ø 1,5 mm
10-955-18 Ø 1,8 mm
10-955-20 Ø 2,0 mm

Kieferhöhlenpunktionskanülen
Antrum trocar needles
Cánula para punción del seno maxilar
Trequarti per puntura del seno mascellare

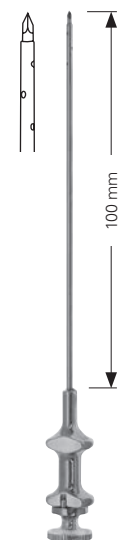

LICHTWITZ

10-956-15 Ø 1,5 mm
10-956-18 Ø 1,8 mm
10-956-20 Ø 2,0 mm
10-956-25 Ø 2,5 mm

Kieferhöhlenspülkanülen
Antrum irrigation cannulas
Cánula para irrigación del seno maxilar
Cannule per irrigazione del seno mascellare



EICKEN

10-957-25	Ø 2,5 mm
10-957-30	Ø 3,0 mm
10-957-40	Ø 4,0 mm

Kieferhöhlenspülkanülen
Antrum irrigation cannulas
Cánula para irrigación del seno maxilar
Cannule per irrigazione del seno mascellare

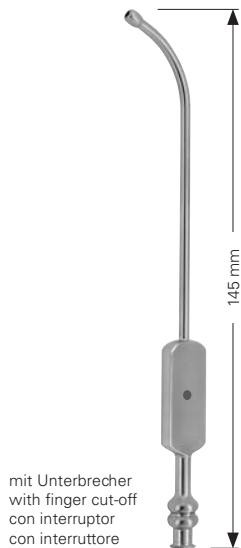

EICKEN

10-957-26	Ø 2,5 mm
10-957-31	Ø 3,0 mm
10-957-41	Ø 4,0 mm

Kieferhöhlenspülkanülen
Antrum irrigation cannulas
Cánula para irrigación del seno maxilar
Cannule per irrigazione del seno mascellare

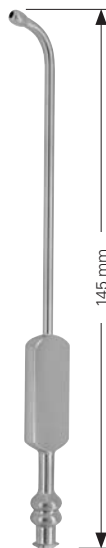

EICKEN

10-958-25	Ø 2,5 mm
10-958-30	Ø 3,0 mm
10-958-40	Ø 4,0 mm

Kieferhöhlenspülkanülen
Antrum irrigation cannulas
Cánula para irrigación del seno maxilar
Cannule per irrigazione del seno mascellare



EICKEN

10-958-26	Ø 2,5 mm
10-958-31	Ø 3,0 mm
10-958-41	Ø 4,0 mm

biegsam
malleable
maleables
malleabili



10-960-05	Ø 0,5 mm
10-960-07	Ø 0,7 mm
10-960-10	Ø 1,0 mm
10-960-13	Ø 1,3 mm
10-960-15	Ø 1,5 mm
10-960-20	Ø 2,0 mm
10-960-25	Ø 2,5 mm
10-960-30	Ø 3,0 mm

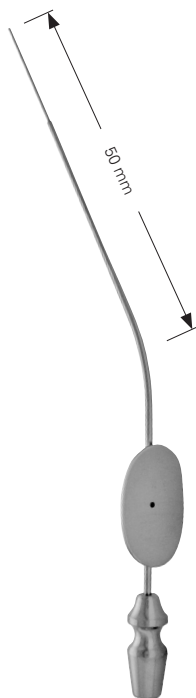

BARNES

10-961-15	Ø 1,5 mm
10-961-17	Ø 1,7 mm
10-961-20	Ø 2,0 mm

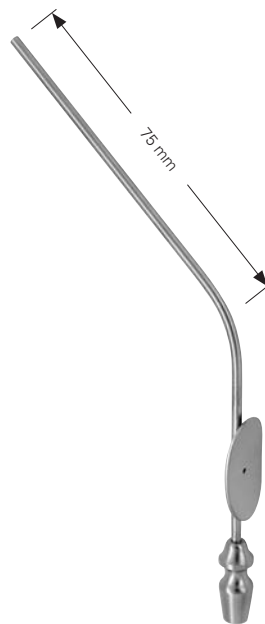

BARON

10-962-03	3 Charr.
10-962-05	5 Charr.
10-962-07	7 Charr.

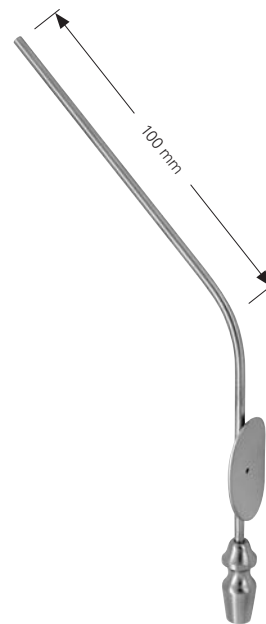

BARON

10-963-03	3 Charr.
10-963-05	5 Charr.
10-963-07	7 Charr.

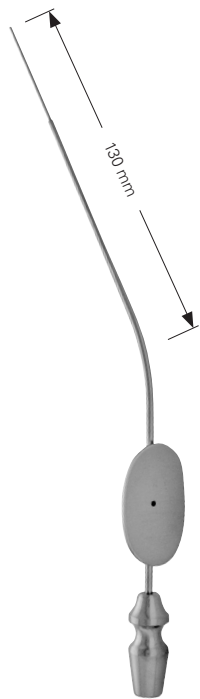

SCHUHKNECHT

10-963-20	Ø 1,0 mm
10-963-24	Ø 0,5 mm

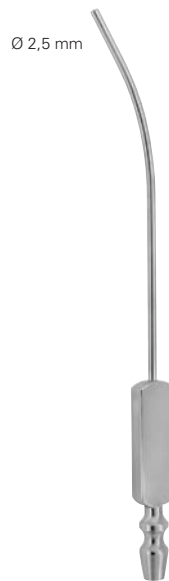

ZOELLNER

10-964-00	15,0 cm, 6 "
------------------	--------------

Saugkanülen Aufsätze für 10-964-00
Suction cannula tips for 10-964-00
Puntas, cánula para aspiración, para 10-964-00
Punta cannulata d'aspirazione, pour 10-964-00



ZOELLNER

10-964-05	Ø 0,5 mm
10-964-07	Ø 0,7 mm
10-964-09	Ø 0,9 mm
10-964-12	Ø 1,2 mm

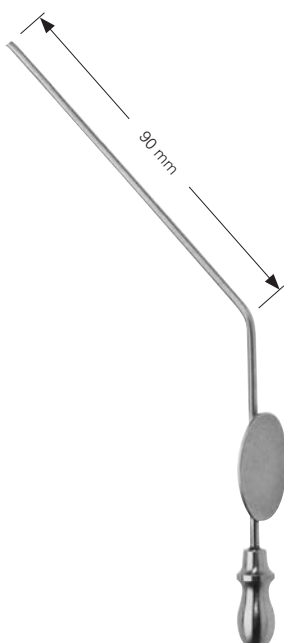

VERHOEVEN 45°

10-965-12	Ø 1,2 mm
10-965-15	Ø 1,5 mm
10-965-20	Ø 2,0 mm
10-965-30	Ø 3,0 mm

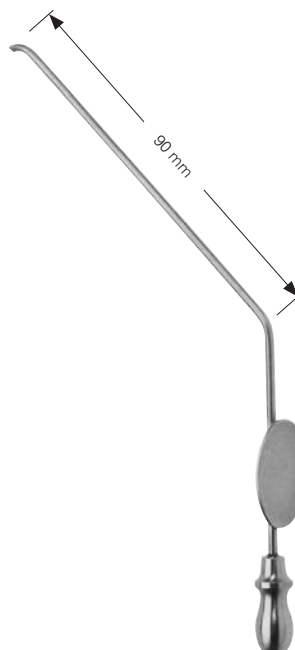

VERHOEVEN 45°

10-966-12	Ø 1,2 mm
10-966-15	Ø 1,5 mm
10-966-20	Ø 2,0 mm
10-966-30	Ø 3,0 mm

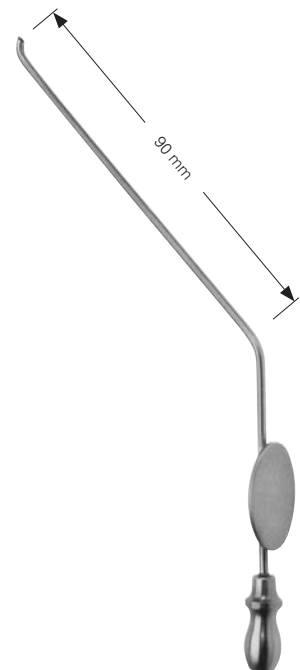

VERHOEVEN 45°

10-967-12	Ø 1,2 mm
10-967-15	Ø 1,5 mm
10-967-20	Ø 2,0 mm
10-967-30	Ø 3,0 mm



11



Scheren

Scissors

Tijeras

Forbici

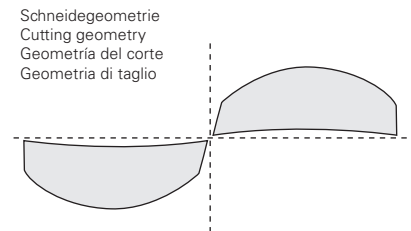
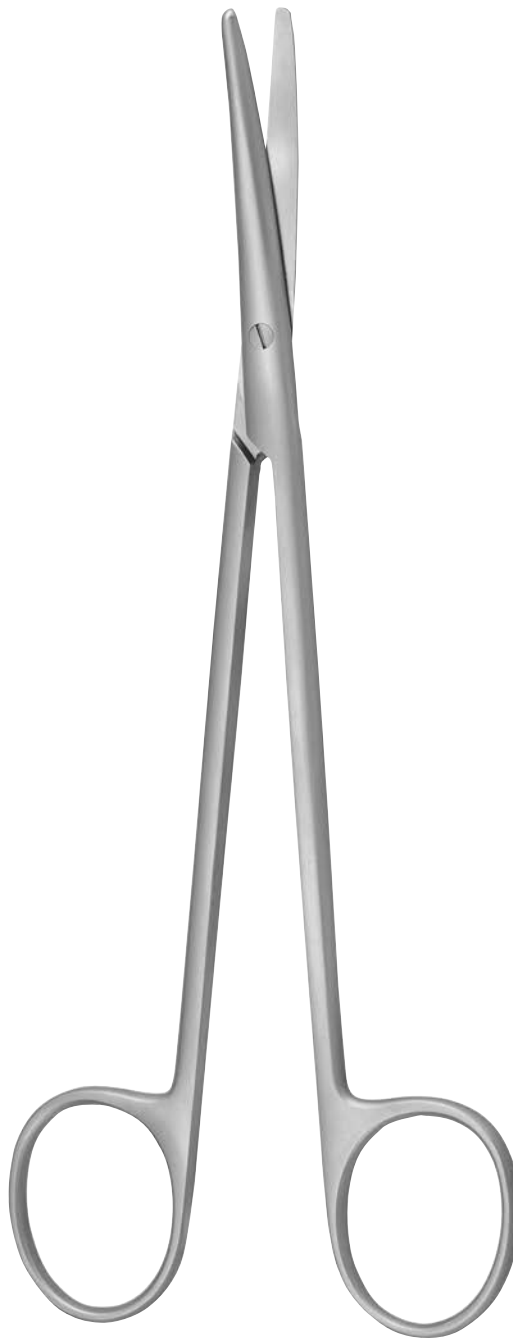

Ausführung I Specification
Especificación I Specifica

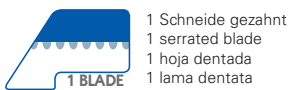
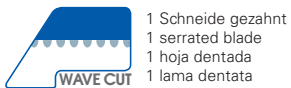

- Jede AMNOTEC Schere wird aus hochwertigem Scherenstahl gefertigt. Für eine dauerhaft exzellente Schnittleistung garantieren speziell vergütete Schneiden, konstante Härte und eine qualitätsgerechte Schnittprüfung vor Auslieferung.
- Every pair of AMNOTEC scissors is manufactured from high-quality cutter-grade steel. Specially tempered blades, consistent hardness and cutting tests to ensure quality before shipping guaranteed outstanding and continuing cutting performance.
- Todas las tijeras AMNOTEC se fabrican en acero de alta calidad para tijeras. El tratamiento especial que reciben las hojas, así como la dureza constante y la revisión de calidad que se realiza antes de la entrega, garantizan un rendimiento de corte excelente y duradero.
- Tutte le forbici AMNOTEC sono realizzate in acciaio di qualità superiore. Le lame dalla durezza costante, realizzate mediante speciale lavorazione e sottoposte a controlli di qualità prima della distribuzione, garantiscono prestazioni di taglio costanti ed eccellenti.

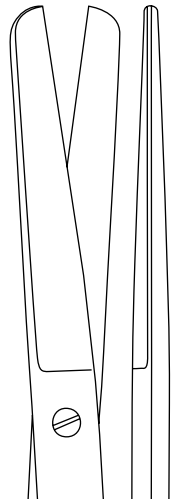

STANDARD Fig. 1

11-000-10	10,0 cm, 4"
11-000-11	11,0 cm, 4 3/8"
11-000-13	13,0 cm, 5 1/8"
11-000-14	14,0 cm, 5 1/2"
11-000-15	15,0 cm, 6"
11-000-16	16,0 cm, 6 1/4"
11-000-17	17,0 cm, 6 3/4"
11-000-18	18,0 cm, 7"
11-000-20	20,0 cm, 8"



STANDARD Fig. 1

11-001-10	10,0 cm, 4"
11-001-11	11,0 cm, 4 3/8"
11-001-13	13,0 cm, 5 1/8"
11-001-14	14,0 cm, 5 1/2"
11-001-15	15,0 cm, 6"
11-001-16	16,0 cm, 6 1/4"
11-001-17	17,0 cm, 6 3/4"
11-001-18	18,0 cm, 7"
11-001-20	20,0 cm, 8"

STANDARD



Fig. 2

11-002-14 W 14,0 cm, 5 1/2"

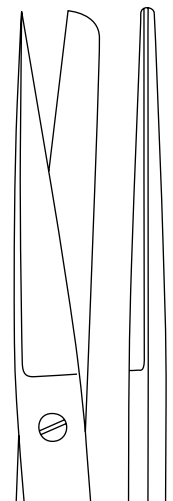

STANDARD Fig. 2

11-002-10	10,0 cm, 4"
11-002-11	11,0 cm, 4 3/8"
11-002-13	13,0 cm, 5 1/8"
11-002-14	14,0 cm, 5 1/2"
11-002-15	15,0 cm, 6"
11-002-16	16,0 cm, 6 1/4"
11-002-17	17,0 cm, 6 3/4"
11-002-18	18,0 cm, 7"
11-002-20	20,0 cm, 8"

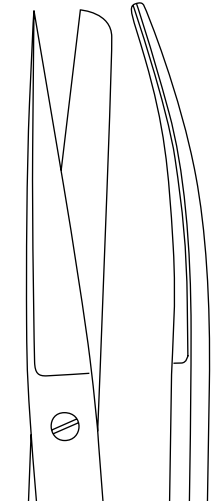

STANDARD Fig. 2

11-003-10	10,0 cm, 4"
11-003-11	11,0 cm, 4 3/8"
11-003-13	13,0 cm, 5 1/8"
11-003-14	14,0 cm, 5 1/2"
11-003-15	15,0 cm, 6"
11-003-16	16,0 cm, 6 1/4"
11-003-17	17,0 cm, 6 3/4"
11-003-18	18,0 cm, 7"
11-003-20	20,0 cm, 8"

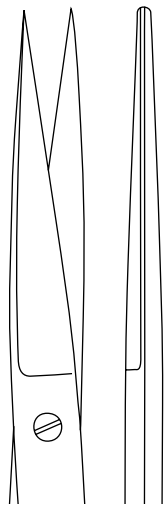

STANDARD Fig. 3

11-004-10	10,0 cm, 4 "
11-004-11	11,0 cm, 4 3/8 "
11-004-13	13,0 cm, 5 1/8 "
11-004-14	14,0 cm, 5 1/2 "
11-004-15	15,0 cm, 6 "
11-004-16	16,0 cm, 6 1/4 "
11-004-17	17,0 cm, 6 3/4 "
11-004-18	18,0 cm, 7 "
11-004-20	20,0 cm, 8 "



STANDARD Fig. 3

11-005-10	10,0 cm, 4 "
11-005-11	11,0 cm, 4 3/8 "
11-005-13	13,0 cm, 5 1/8 "
11-005-14	14,0 cm, 5 1/2 "
11-005-15	15,0 cm, 6 "
11-005-16	16,0 cm, 6 1/4 "
11-005-17	17,0 cm, 6 3/4 "
11-005-18	18,0 cm, 7 "
11-005-20	20,0 cm, 8 "

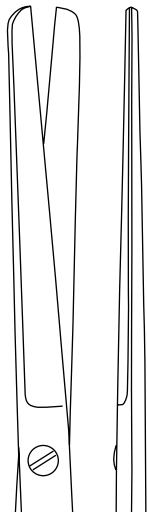

11-010-13
11-010-14

schlanke Modelle
delicate pattern
modelos finos
modelli fini

GRAZIL Fig. 1

11-010-13	13,0 cm, 5 1/8 "
11-010-14	14,0 cm, 5 1/2 "



11-011-13
11-011-14

schlanke Modelle
delicate pattern
modelos finos
modelli fini

GRAZIL Fig. 1

11-011-13	13,0 cm, 5 1/8 "
11-011-14	14,0 cm, 5 1/2 "

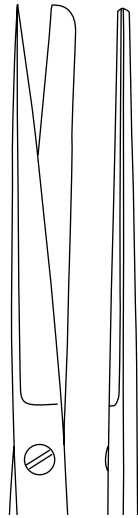

11-012-13
11-012-14

schlanke Modelle
delicate pattern
modelos finos
modelli fini

GRAZIL **Fig. 2**

11-012-13	13,0 cm, 5 1/8"
11-012-14	14,0 cm, 5 1/2"



11-013-13
11-013-14

schlanke Modelle
delicate pattern
modelos finos
modelli fini

GRAZIL **Fig. 2**

11-013-13	13,0 cm, 5 1/8"
11-013-14	14,0 cm, 5 1/2"

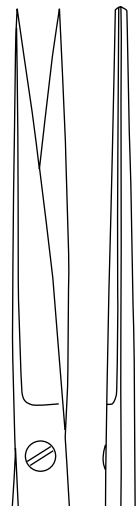

11-014-13
11-014-14

schlanke Modelle
delicate pattern
modelos finos
modelli fini

GRAZIL **Fig. 3**

11-014-13	13,0 cm, 5 1/8"
11-014-14	14,0 cm, 5 1/2"

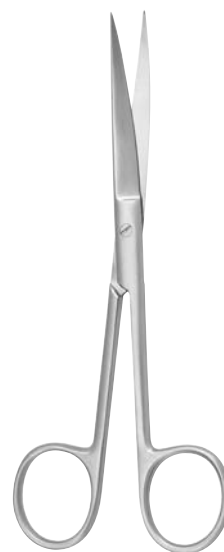

11-015-13
11-015-14

schlanke Modelle
delicate pattern
modelos finos
modelli fini

GRAZIL **Fig. 3**

11-015-13	13,0 cm, 5 1/8"
11-015-14	14,0 cm, 5 1/2"

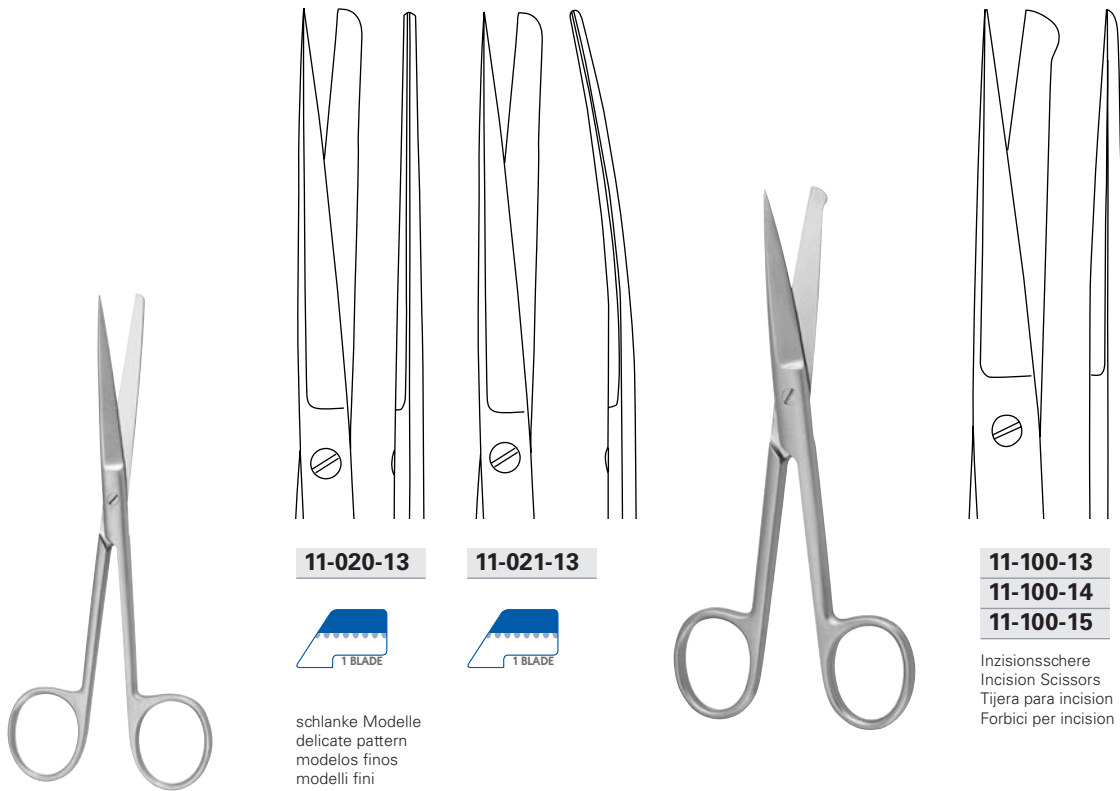

GRAZIL

Fig. 2

11-020-13 - 11-021-13 13,0 cm, 5 1/8"

11-100-13	13,0 cm, 5 1/8"
11-100-14	14,0 cm, 5 1/2"
11-100-15	15,0 cm, 6"

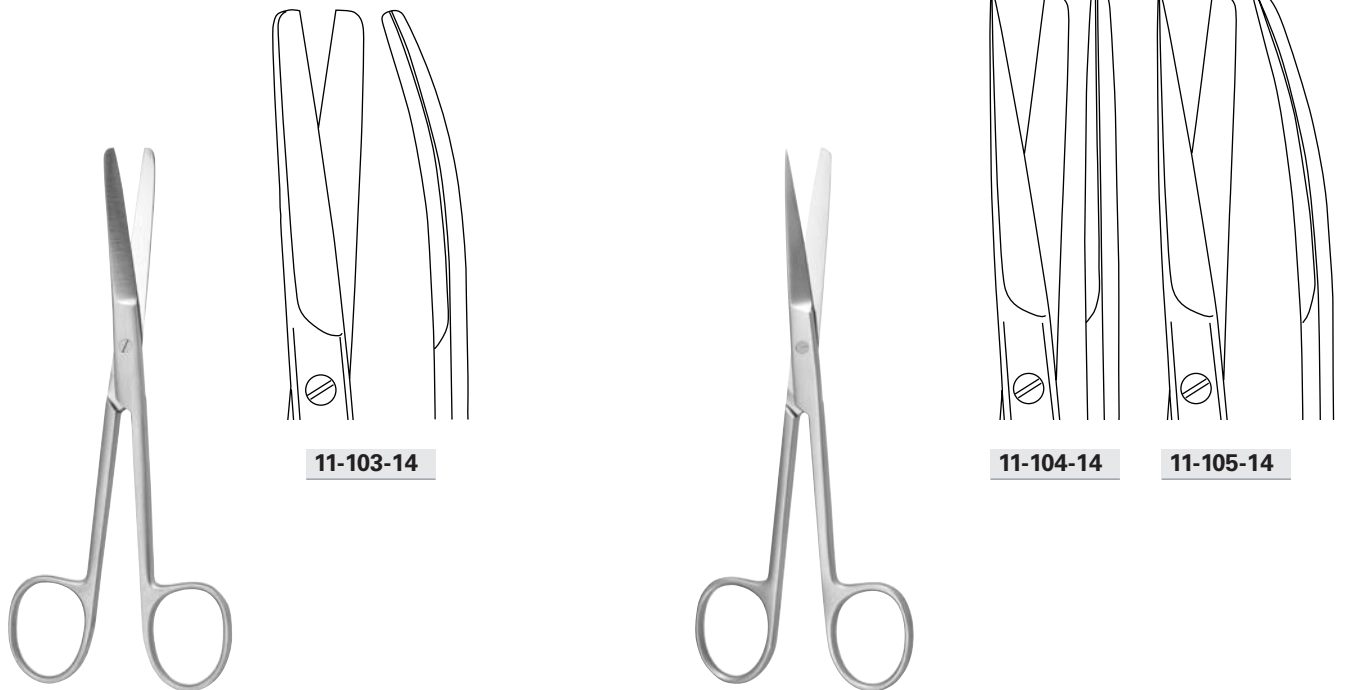

DEAVER

11-103-14 14,0 cm, 5 1/2"

DEAVER

11-104-14 - 11-105-14 14,0 cm, 5 1/2"

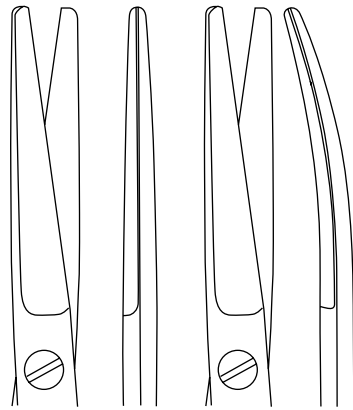

11-106-15

11-107-15

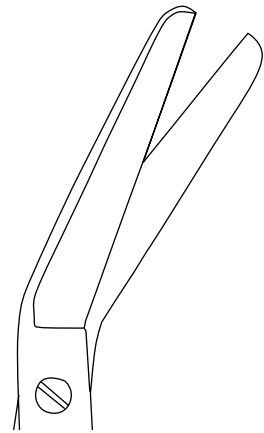

11-109-14

MIXTER

11-106-15 - 11-107-15 15,0 cm, 6"

RICHTER

11-109-14 14,0 cm, 5 1/2"

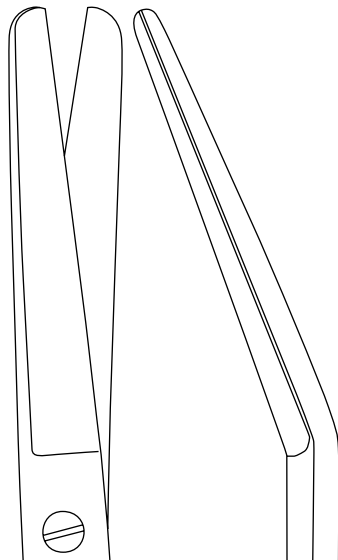

11-111-16

11-111-18

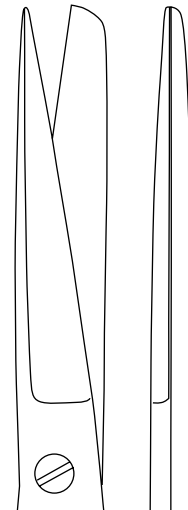

11-112-16

Bauchdeckenschere
Abdominal scissors
Tijeras abdominales
Forbici per pareti abdominali

FERGUSON

11-111-16 16,0 cm, 6 1/4"

11-111-18 18,0 cm, 7"

DOYEN

11-112-16 16,0 cm, 6 1/4"

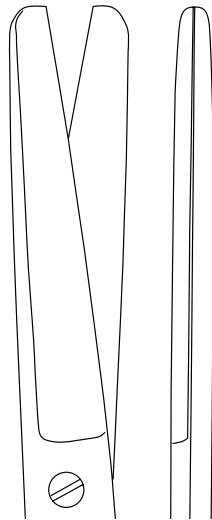

11-114-16
11-114-18

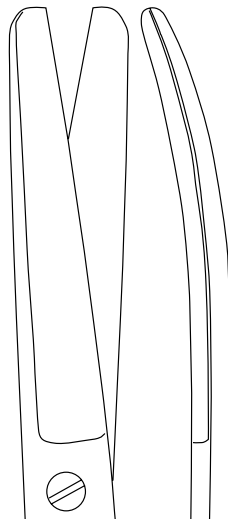

11-115-16
11-115-18

Bauchdeckenscheren
Abdominal scissors
Tijeras abdominales
Forbici per pareti abdominali

DOYEN

11-114-16 - 11-115-16	16,0 cm, 6 1/4 "
11-114-18 - 11-115-86	18,0 cm, 7 "

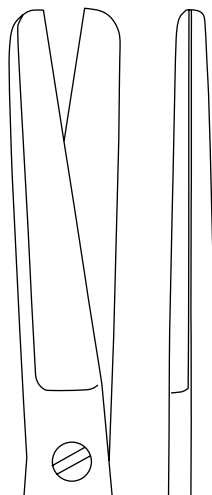

11-120-20
11-120-23
11-120-25

Uterusscheren
Uterine scissors
Tijeras uterinas
Forbici da uteroa



11-121-20
11-121-23
11-121-25

Uterusscheren
Uterine scissors
Tijeras uterinas
Forbici da uteroa

SIMS

11-120-20 - 11-121-20	20,0 cm, 8 "
11-120-23 - 11-121-23	23,0 cm, 9 "
11-120-25 - 11-121-25	25,0 cm, 9 3/4 "

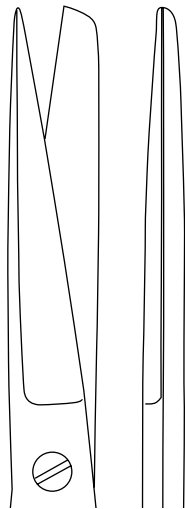

11-122-20
11-122-23
11-122-25

Uterusscheren
 Uterine scissors
 Tijeras uterinas
 Forbici da uteroa



11-123-20
11-123-23
11-123-25

Uterusscheren
 Uterine scissors
 Tijeras uterinas
 Forbici da uteroa

SIMS

11-122-20 - 11-123-20	20,0 cm, 8 "
11-122-23 - 11-123-23	23,0 cm, 9 "
11-122-25 - 11-123-25	25,0 cm, 9 3/4 "

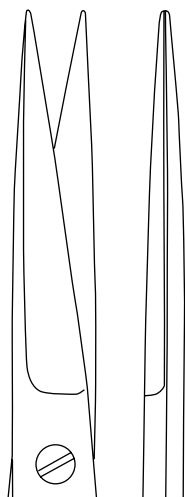

11-124-20
11-124-23
11-124-25

Uterusscheren
 Uterine scissors
 Tijeras uterinas
 Forbici da uteroa



11-125-20
11-125-23
11-125-25

Uterusscheren
 Uterine scissors
 Tijeras uterinas
 Forbici da uteroa

SIMS

11-124-20 - 11-125-20	20,0 cm, 8 "
11-124-23 - 11-125-23	23,0 cm, 9 "
11-124-25 - 11-125-25	25,0 cm, 9 3/4 "

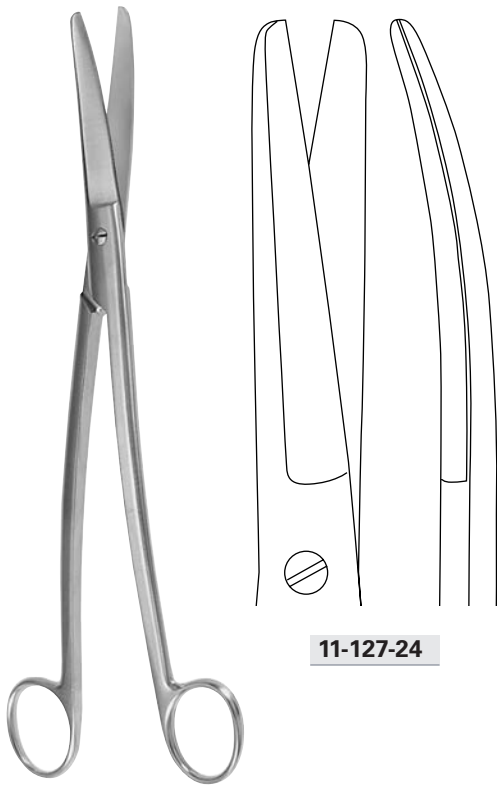

11-127-24

SIMS-SIEBOLD-S

11-127-24 24,0 cm, 9 1/2"

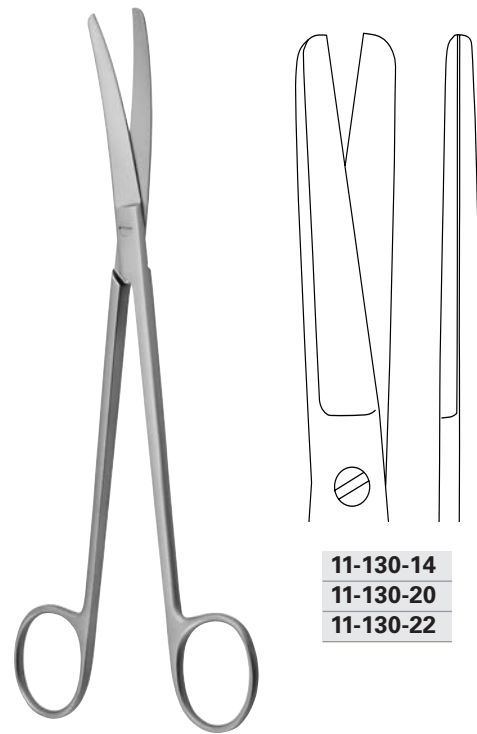

11-130-14
11-130-20
11-130-22

WERTHEIM

11-130-14	14,0 cm, 5 1/2"
11-130-20	20,0 cm, 8"
11-130-22	22,0 cm, 8 3/4"

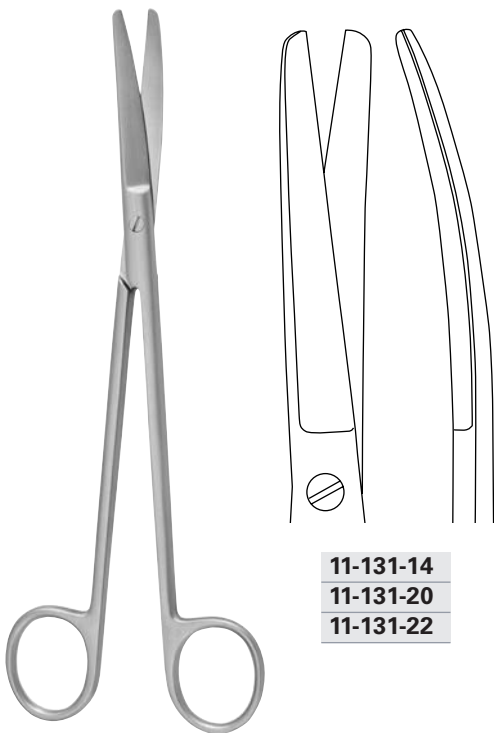

11-131-14
11-131-20
11-131-22

WERTHEIM

11-131-14	14,0 cm, 5 1/2"
11-131-20	20,0 cm, 8"
11-131-22	22,0 cm, 8 3/4"

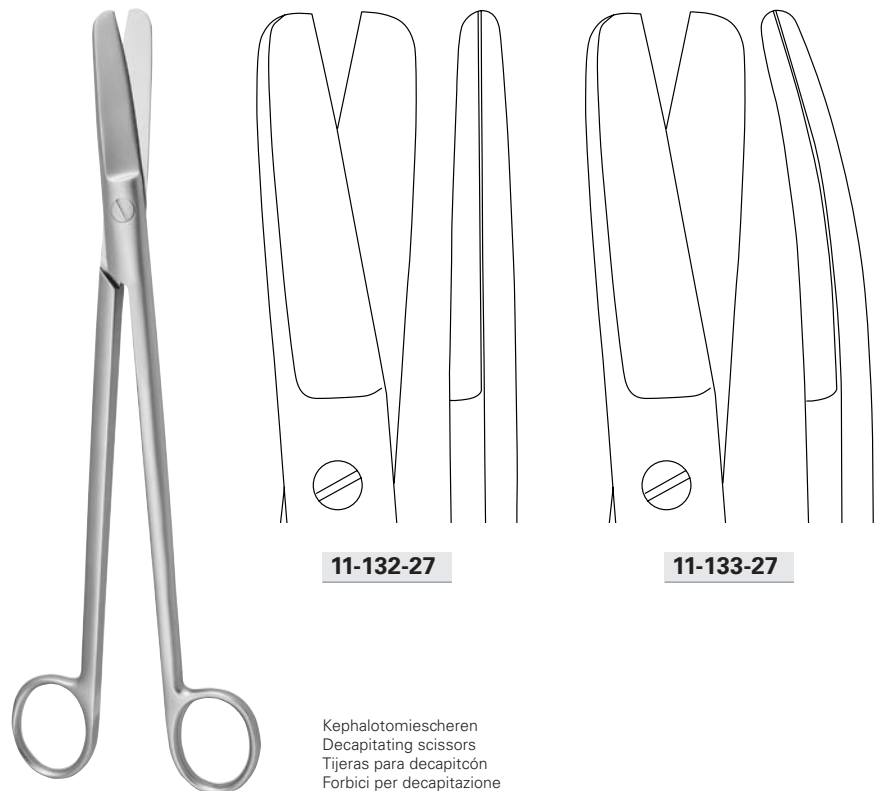

11-132-27

11-133-27

DUBOIS

11-132-27 - 11-133-27 27,0 cm, 10 3/4"

Kephalotomiescheren
Decapitating scissors
Tijeras para decapitaci3n
Forbici per decapitazione

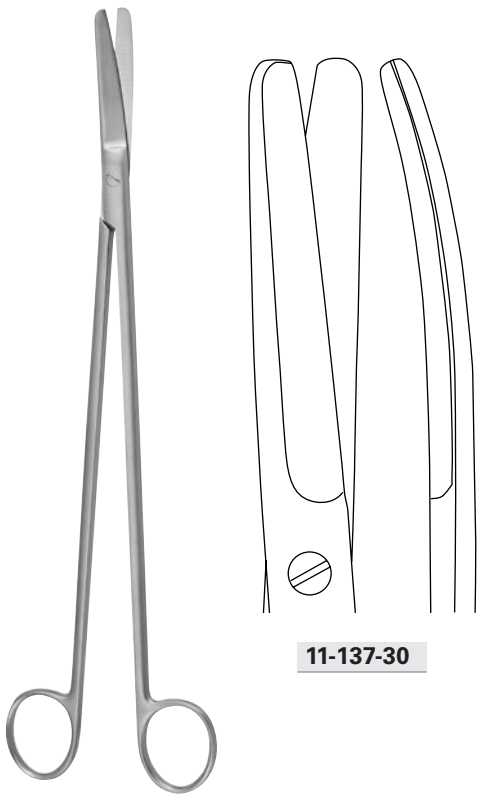

11-137-30

CRAFOORD

11-137-30 30,0 cm, 11 3/4"

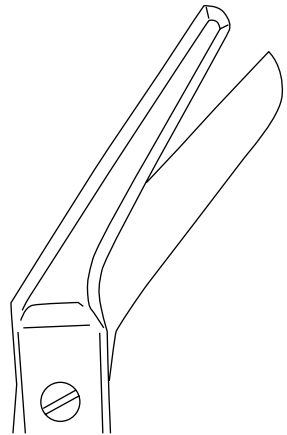

11-139-14
11-139-22

Damm Scheren (Episiotomie)
Perineum scissors (Episiotomy)
Tijeras para perineo (episiotomía)
Forbici per perineo (episiotomia)

BRAUN-STADLER

11-139-14 14,0 cm, 5 1/2"
11-139-22 22,0 cm, 8 3/4"

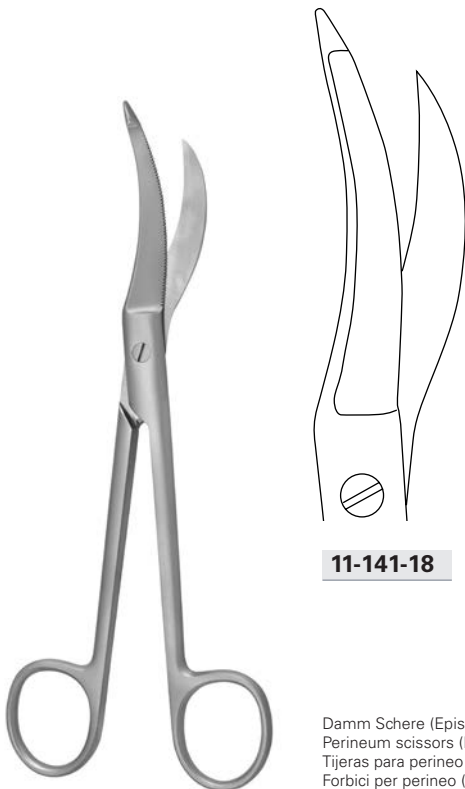

11-141-18

Damm Schere (Episiotomie)
Perineum scissors (Episiotomy)
Tijeras para perineo (episiotomía)
Forbici per perineo (episiotomia)

WALDMANN

11-141-18 18,0 cm, 7"



11-141-20

Damm Schere (Episiotomie)
Perineum scissors (Episiotomy)
Tijeras para perineo (episiotomía)
Forbici per perineo (episiotomia)



WALDMANN

11-141-20 20,0 cm, 8"

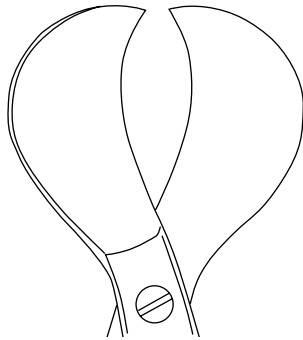

11-144-10

Nabelschnurschere
Umbilical cord scissors
Tijera umbilicales
Forbici ombelicali

MOD. USA

11-144-10 10,0 cm, 4"

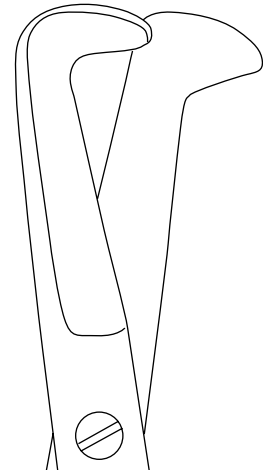

11-145-16

Nabelschnurschere
Umbilical cord scissors
Tijera umbilicales
Forbici ombelicali

SCHUMACHER

11-145-16 16,0 cm, 6 ¼"



11-147-13
11-147-16

Nabelschnurscheren
Umbilical cord scissors
Tijera umbilicales
Forbici ombelicali

BUSCH

11-147-13 13,0 cm, 5 ⅛"
11-147-16 16,0 cm, 6 ¼"

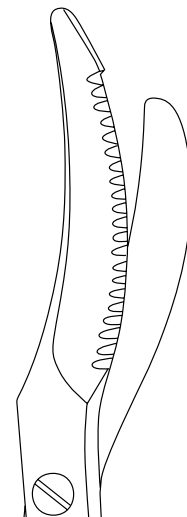
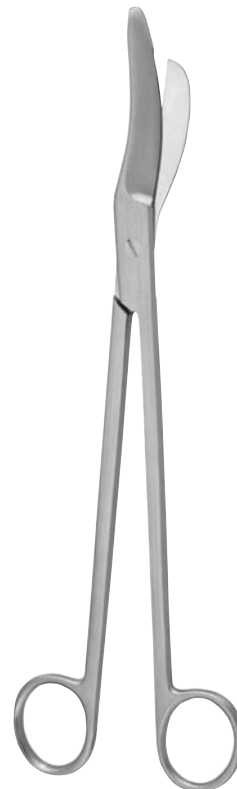

11-149-24

Damm Schere (Episiotomie)
Perineum scissors (Episiotomy)
Tijeras para perineo (episiotomia)
Forbici per perineo (episiotomia)



11-149-24 24,0 cm, 9 ½"



11-150-21 21,0 cm, 8 ¼"



11-152-21 21,0 cm, 8 ¼"



11-154-21 21,0 cm, 8 ¼"

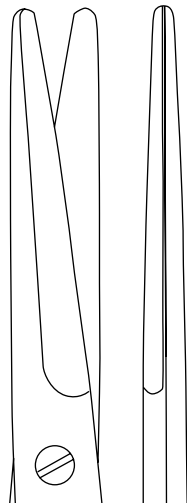

MAYO

11-160-14	14,0 cm, 5 ½"
11-160-15	15,0 cm, 6"
11-160-17	17,0 cm, 6 ¾"
11-160-19	19,0 cm, 7 ½"
11-160-23	23,0 cm, 9"
11-160-30	30,0 cm, 11 ¾"



MAYO

11-161-14	14,0 cm, 5 ½"
11-161-15	15,0 cm, 6"
11-161-17	17,0 cm, 6 ¾"
11-161-19	19,0 cm, 7 ½"
11-161-23	23,0 cm, 9"
11-161-30	30,0 cm, 11 ¾"

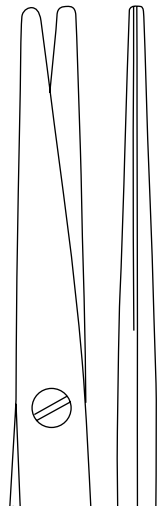

MAYO-STILLE

11-170-15	15,0 cm, 6 "
11-170-17	17,0 cm, 6 3/4 "
11-170-19	19,0 cm, 7 1/2 "
11-170-21	21,0 cm, 8 1/4 "
11-170-23	23,0 cm, 9 "

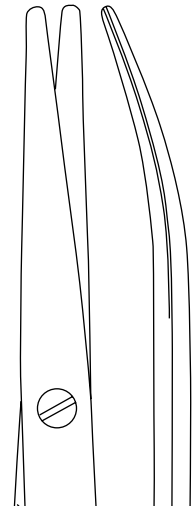

MAYO-STILLE

11-171-15	15,0 cm, 6 "
11-171-17	17,0 cm, 6 3/4 "
11-171-19	19,0 cm, 7 1/2 "
11-171-21	21,0 cm, 8 1/4 "
11-171-23	23,0 cm, 9 "

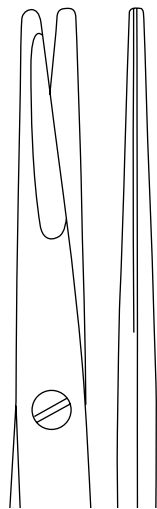

abgeschrägte Blätter
chamfered blades
Hojas achaflanadas
Valve oblique

MAYO-STILLE

11-172-14	14,0 cm, 5 1/2 "
11-172-17	17,0 cm, 6 3/4 "
11-172-19	19,0 cm, 7 1/2 "
11-172-21	21,0 cm, 8 1/4 "

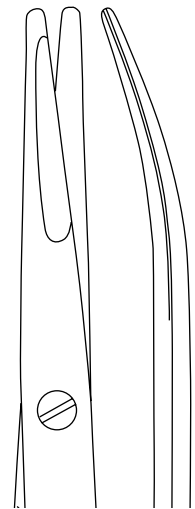

abgeschrägte Blätter
chamfered blades
Hojas achaflanadas
Valve oblique

MAYO-STILLE

11-173-14	14,0 cm, 5 1/2 "
11-173-17	17,0 cm, 6 3/4 "
11-173-19	19,0 cm, 7 1/2 "
11-173-21	21,0 cm, 8 1/4 "

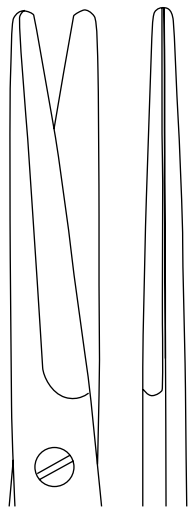

11-166-22



11-167-22

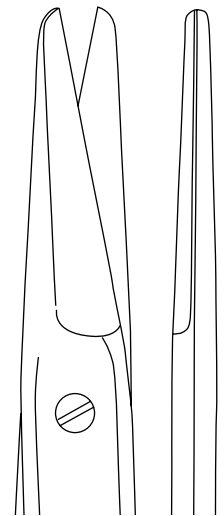

11-176-17

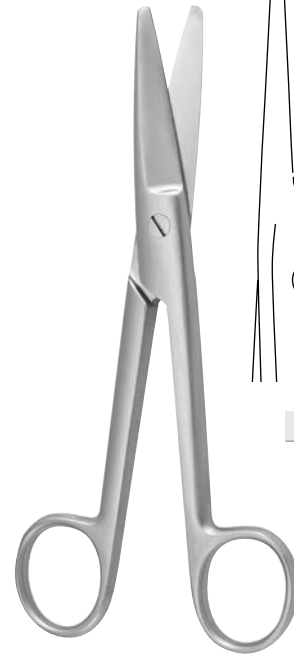

MAYO-HARRINGTON

11-166-22 - 11-167-22 22,0 cm, 8 3/4"

MAYO-NOBLE

11-176-17 17,0 cm, 6 3/4"

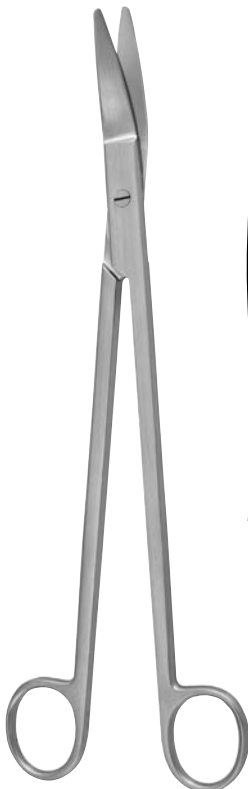

11-175-24



11-175-25



11-177-17



Kapselscheren
 Capsula scissors
 Tijeras de cápsula
 Forbice per capsula

RESANO

11-175-24 - 11-175-25 24,5 cm, 9 2/3"

MAYO-NOBLE

11-177-17 17,0 cm, 6 3/4"

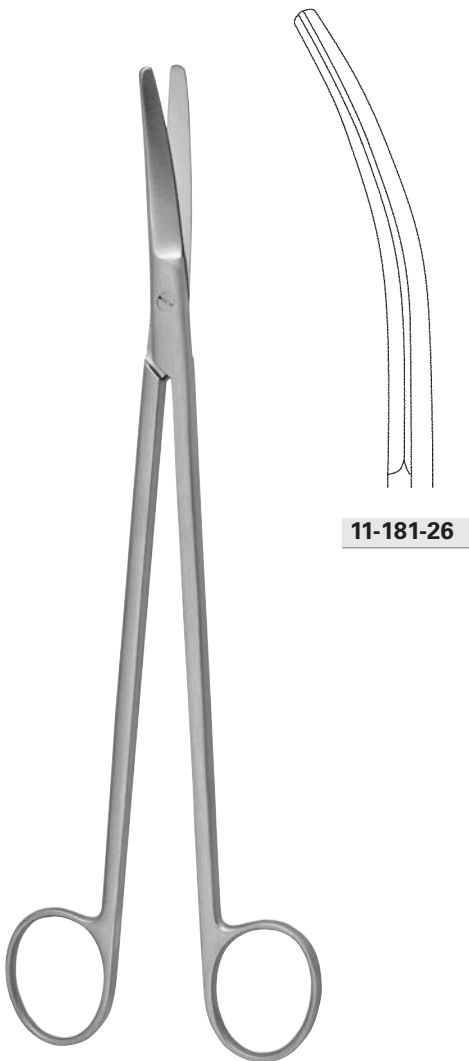

11-181-26

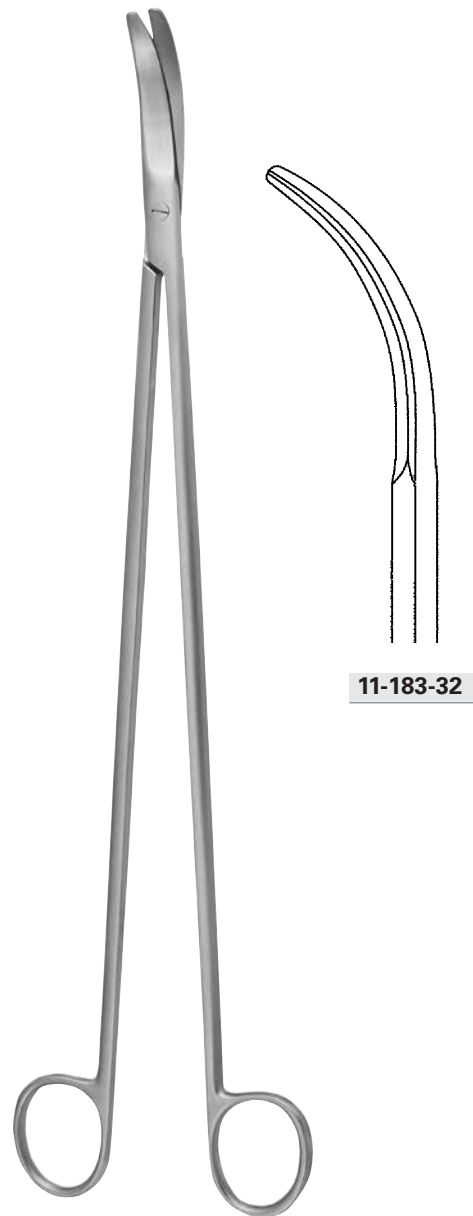

11-183-32

LLOYD-DAVIES

11-181-26 26,0 cm, 10 ¼"

11-183-32 32,0 cm, 12 ½"

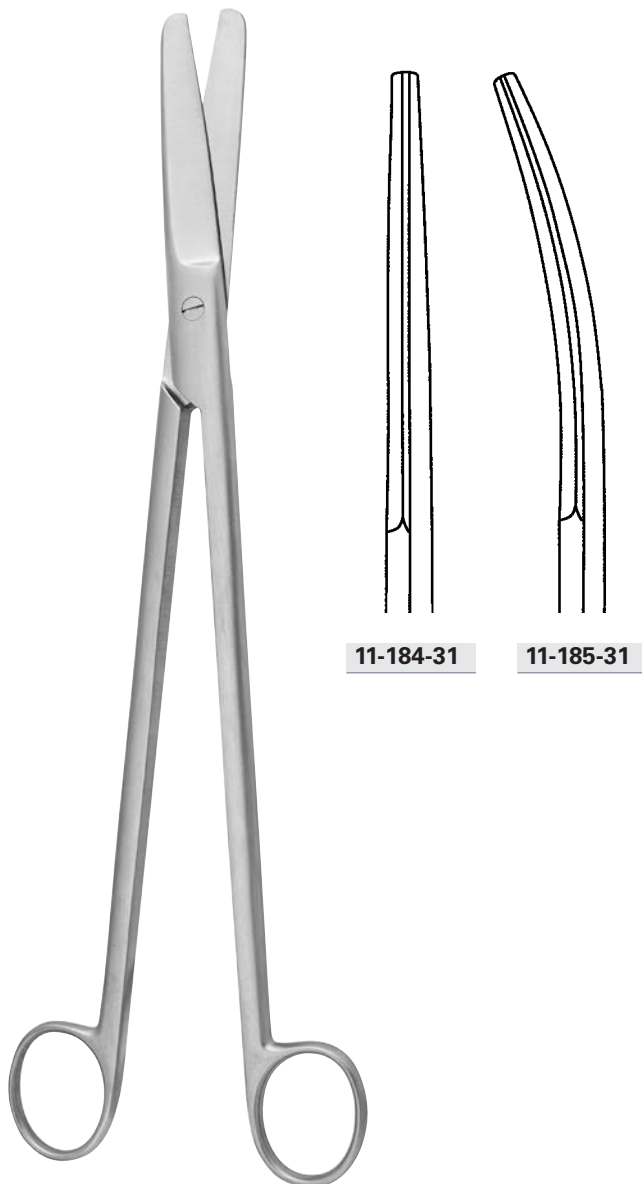

STELZNER

11-184-31 - 11-185-31 31,0 cm, 12 1/4"

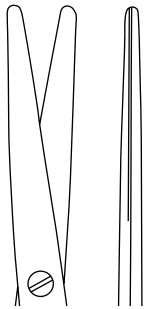
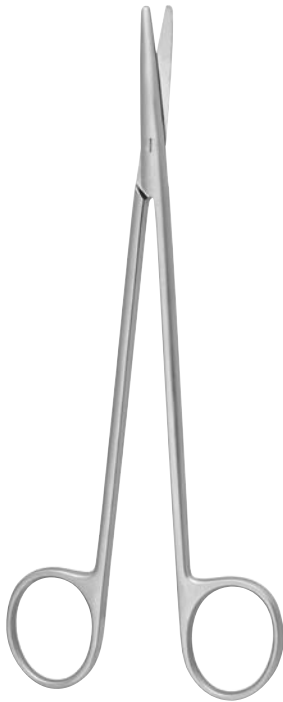

METZENBAUM

11-200-14	14,0 cm, 5 1/2 "
11-200-18	18,0 cm, 7 "
11-200-20	20,0 cm, 8 "
11-200-23	23,0 cm, 9 "
11-200-25	25,0 cm, 9 3/4 "
11-200-28	28,0 cm, 11 "
11-200-30	30,0 cm, 12 "
11-200-36	36,0 cm, 14 1/4 "

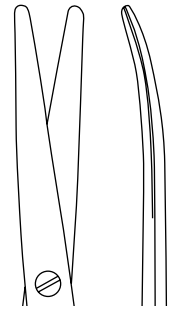
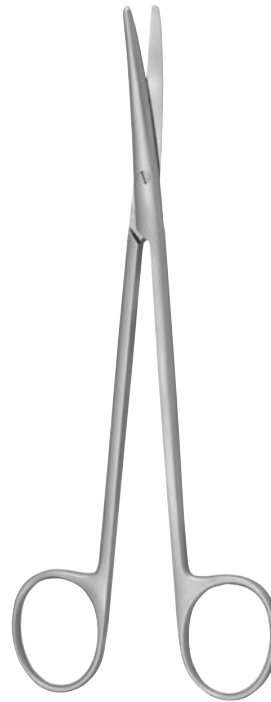

METZENBAUM

11-201-14	14,0 cm, 5 1/2 "
11-201-18	18,0 cm, 7 "
11-201-20	20,0 cm, 8 "
11-201-23	23,0 cm, 9 "
11-201-25	25,0 cm, 9 3/4 "
11-201-28	28,0 cm, 11 "
11-201-30	30,0 cm, 12 "
11-201-36	36,0 cm, 14 1/4 "

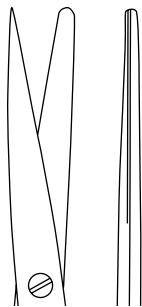
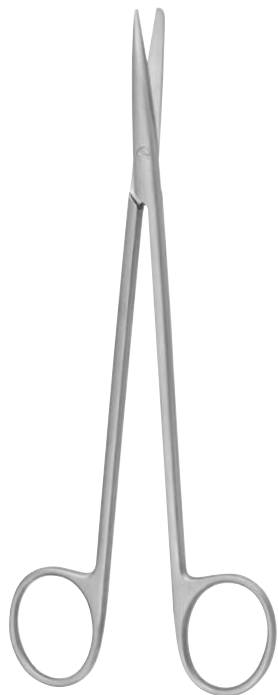

11-202-14
11-202-18
11-202-20

METZENBAUM

11-202-14	14,0 cm, 5 1/2 "
11-202-18	18,0 cm, 7 "
11-202-20	20,0 cm, 8 "

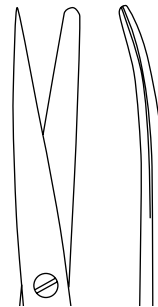
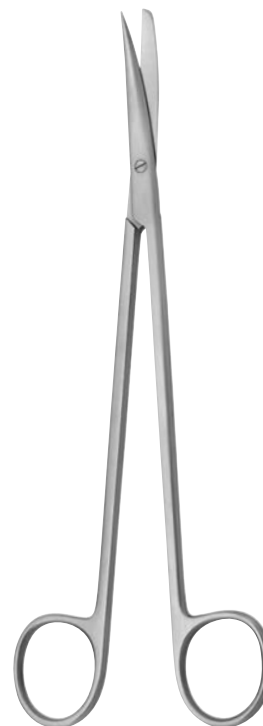

11-203-14
11-203-18
11-203-20

METZENBAUM

11-203-14	14,0 cm, 5 1/2 "
11-203-18	18,0 cm, 7 "
11-203-20	20,0 cm, 8 "

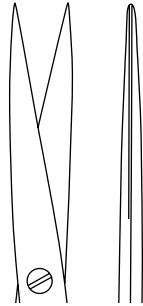
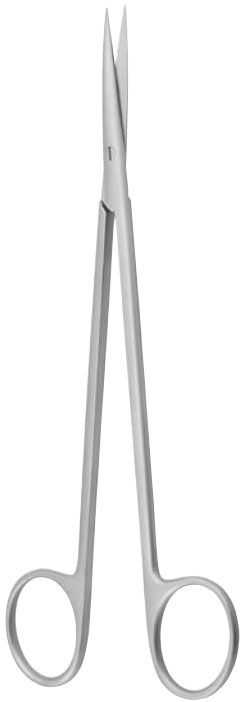

11-204-14
 11-204-18
 11-204-20
 11-204-23

METZENBAUM

11-204-14	14,0 cm, 5 1/2 "
11-204-18	18,0 cm, 7 "
11-204-20	20,0 cm, 8 "
11-204-23	23,0 cm, 9 "



11-209-28

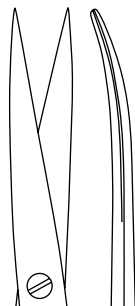

11-205-14

METZENBAUM

11-205-14	14,0 cm, 5 1/2 "
-----------	------------------

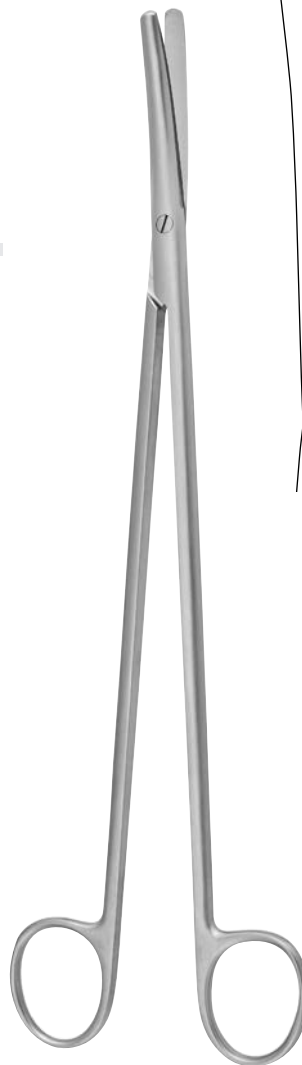

METZENBAUM

11-209-28	28,0 cm, 11 "
-----------	---------------

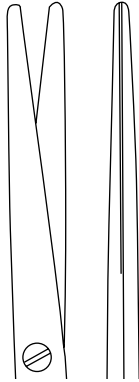

METZENBAUM-FINO

11-210-12	12,0 cm, 4 3/4 "
11-210-14	14,0 cm, 5 1/2 "
11-210-18	18,0 cm, 7 "
11-210-20	20,0 cm, 8 "
11-210-23	23,0 cm, 9 "
11-210-25	25,0 cm, 9 3/4 "

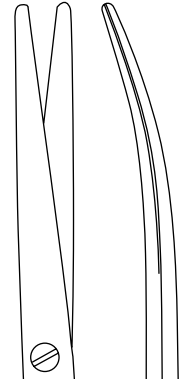

METZENBAUM-FINO

11-211-12	12,0 cm, 4 3/4 "
11-211-14	14,0 cm, 5 1/2 "
11-211-18	18,0 cm, 7 "
11-211-20	20,0 cm, 8 "
11-211-23	23,0 cm, 9 "
11-211-25	25,0 cm, 9 3/4 "
11-211-28	28,0 cm, 11 "
11-211-30	30,0 cm, 12 "

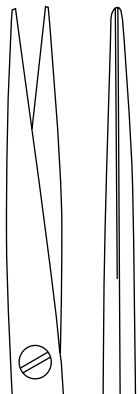
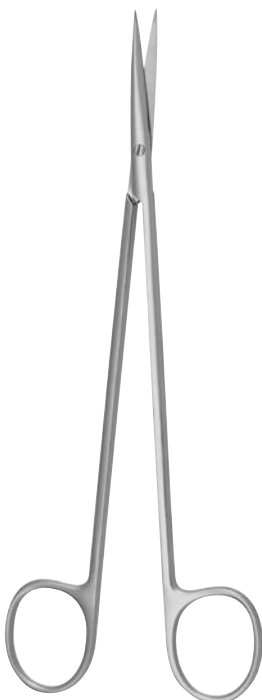

METZENBAUM-FINO

11-214-14	14,0 cm, 5 1/2 "
11-214-18	18,0 cm, 7 "
11-214-20	20,0 cm, 8 "
11-214-23	23,0 cm, 9 "

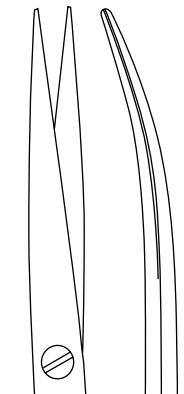
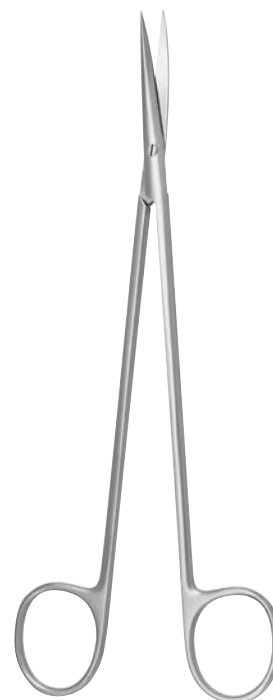

METZENBAUM-FINO

11-215-14	14,0 cm, 5 1/2 "
11-215-18	18,0 cm, 7 "
11-215-20	20,0 cm, 8 "
11-215-23	23,0 cm, 9 "

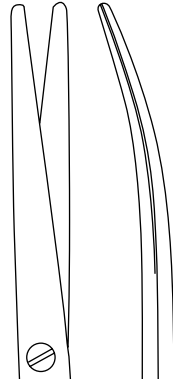
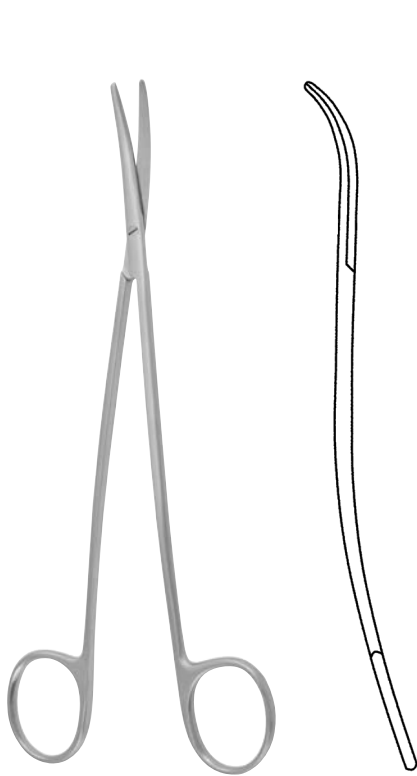

METZENBAUM-FINO-S

11-221-14	14,0 cm, 5 1/2 "
11-221-18	18,0 cm, 7 "
11-221-20	20,0 cm, 8 "
11-221-23	23,0 cm, 9 "
11-221-25	25,0 cm, 9 3/4 "

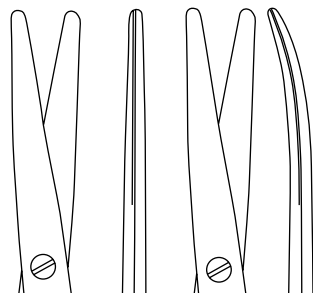

11-226-15

kurze Blätter
 short blades
 hojas corta
 lame corta

11-227-15

kurze Blätter
 short blades
 hojas corta
 lame corta

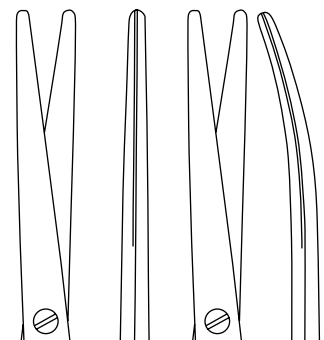

11-228-11

11-229-11

METZENBAUM

11-226-15 - 11-227-15 15,0 cm, 6 "

METZENBAUM-BABY

11-228-11 - 11-229-11 11,0 cm, 4 3/8 "

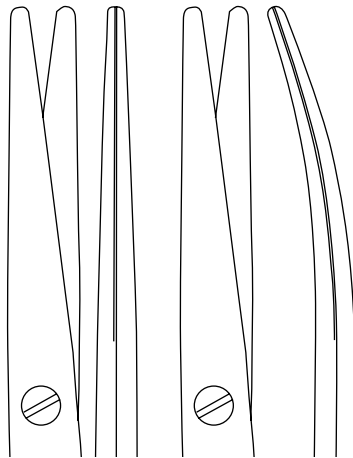

11-230-16

11-231-16

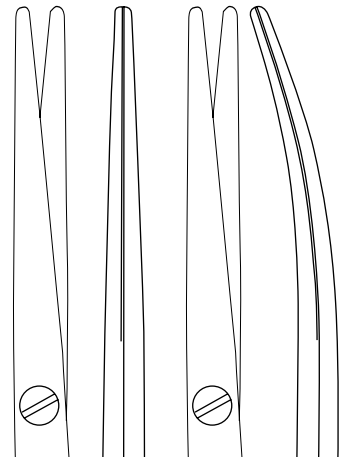

11-232-16

11-233-16

LEXER

11-230-16 - 11-231-16 16,0 cm, 6 ¼"

LEXER-FINO

11-232-16 - 11-233-16 16,0 cm, 6 ¼"

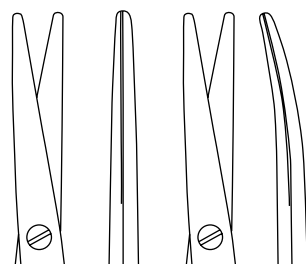

11-234-10

11-235-10

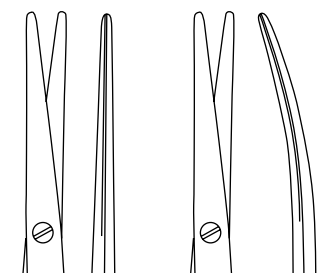

11-236-09
11-236-11

11-237-09
11-237-11

LEXER-BABY

11-234-10 - 11-235-10 10,0 cm, 4"

STRABISMUS

11-236-09 - 11-237-09 9,0 cm, 3 ½"
11-236-11 - 11-237-11 11,0 cm, 4 ⅜"

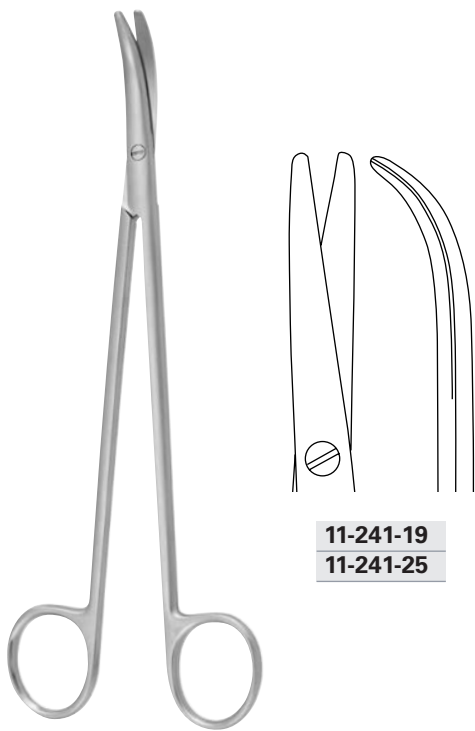

11-241-19
 11-241-25

THOREK

11-241-19	19,0 cm, 7 1/2 "
11-241-25	25,0 cm, 9 3/4 "

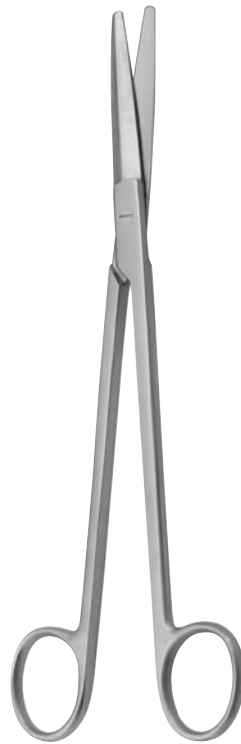

11-242-12

11-242-19

11-243-19

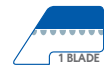

GORNEY

11-242-12	12,5 cm, 5 "
11-242-19 - 11-243-19	19,5 cm, 7 3/4 "

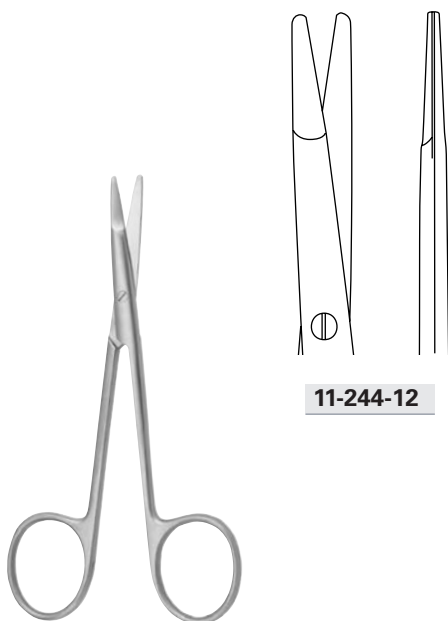

11-244-12

KILNER (RAGNELL)

11-244-12	12,0 cm, 4 3/4 "
-----------	------------------

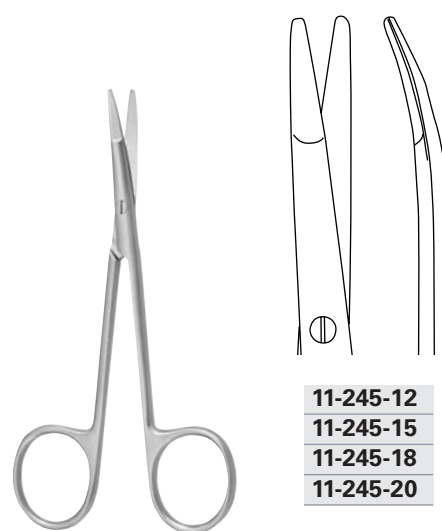

11-245-12

11-245-15

11-245-18

11-245-20

KILNER (RAGNELL)

11-245-12	12,0 cm, 4 3/4 "
11-245-15	15,0 cm, 6 "
11-245-18	18,0 cm, 7 "
11-245-20	20,0 cm, 8 "

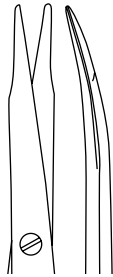

11-247-13
11-247-15

JAMESON

11-247-13	13,0 cm, 5 1/8"
11-247-15	15,0 cm, 6"

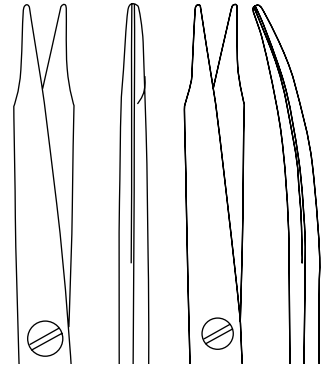

11-248-13
11-248-15
11-248-18

11-249-13
11-249-15
11-249-18

REYNOLDS

11-248-13 - 11-249-13	13,0 cm, 5 1/8"
11-248-15 - 11-249-15	15,0 cm, 6"
11-248-18 - 11-249-18	18,0 cm, 7"

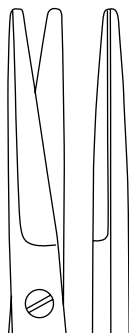
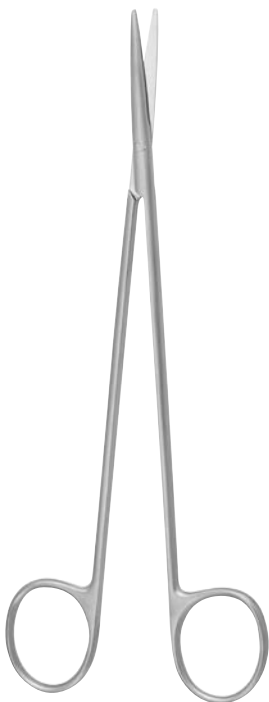

11-250-18

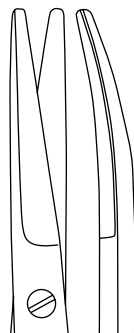

11-251-18

TOENNIS

11-250-18 - 11-251-18	18,0 cm, 7"
-----------------------	-------------

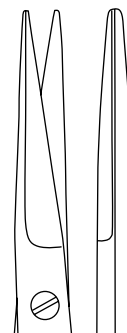
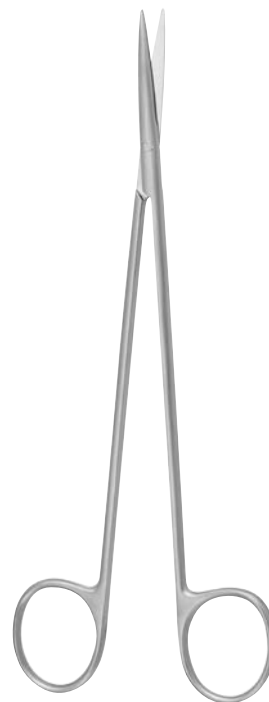

11-252-18

TOENNIS-FINO

11-252-18	18,0 cm, 7"
-----------	-------------

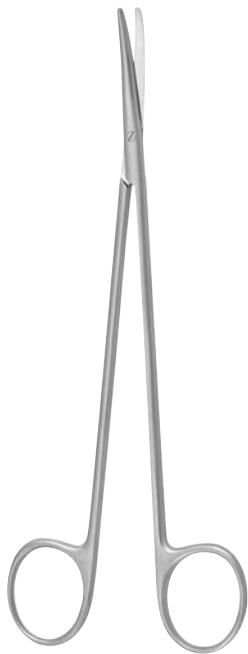

11-253-17



11-255-17

Präparierscheren
 Dissecting scissors
 Tijeras des disección
 Forbici per dissezione

TOENNIS-ADSON

11-253-17 - 11-255-17 17,5 cm, 7 "

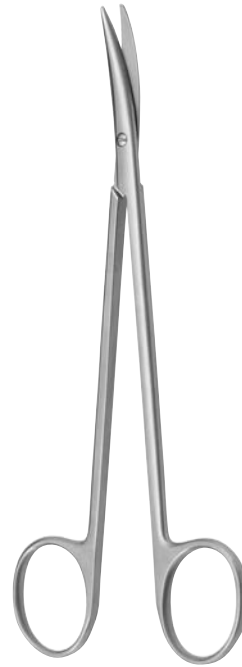

11-257-17

Präparierschere
 Dissecting scissors
 Tijera des disección
 Forbici per dissezione

DE BAKEY

11-257-17 17,5 cm, 7 "

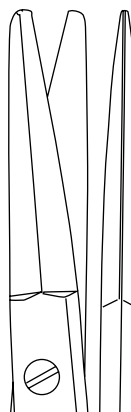

11-300-15

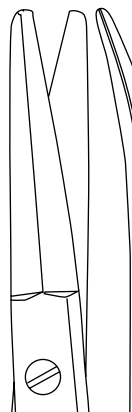

11-301-15

Scheren für die plastische Chirurgie
 Plastic surgery scissors
 Tijeras para la cirugía plástica
 Forbici per la chirurgia plastica

AUFRICHT

11-300-15 - 11-301-15 15,0 cm, 6 "

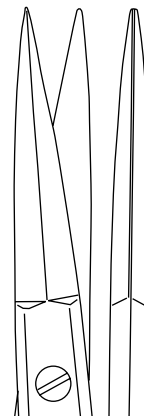

11-300-19

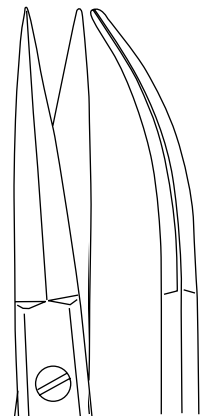

11-301-19

Knorpelscheren
 Cartilage scissors
 Tijeras para cartilago
 Forbici per cartilagini

MC INDOE

11-300-19 - 11-301-19 19,0 cm, 7 1/2 "

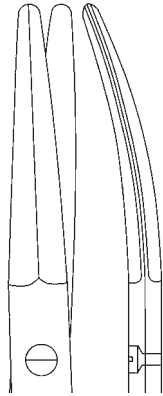
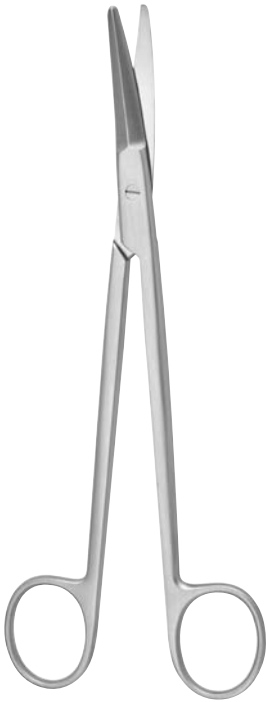

11-301-18

Tonsillenschere
Tonsil scissors
Tijera para amígdalas
Forbici per tonsille

BOETTCHER

11-301-18 18,0 cm, 7 "

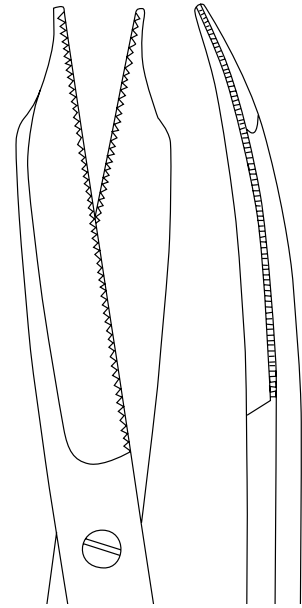
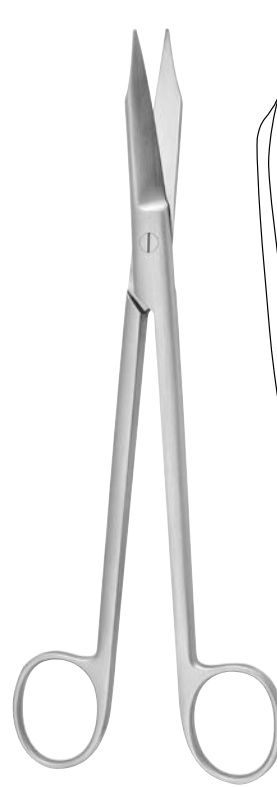

11-301-20



Knorpelschere
Cartilage scissors
Tijeras para cartílago
Forbici per cartilagini

MARTIN

11-301-20 20,0 cm, 8 "

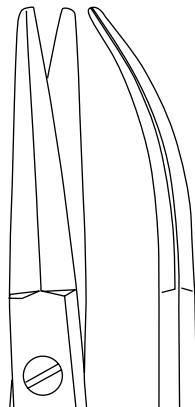

11-303-17

Tonsillenschere
Tonsil scissors
Tijera para amígdalas
Forbici per tonsille

PRINCE

11-303-17 17,0 cm, 6 3/4 "

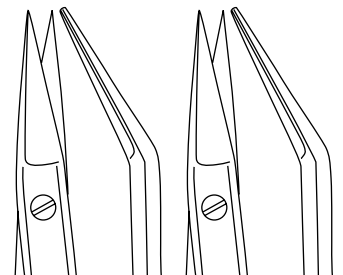

11-305-17

11-307-17



Tonsillenscheren
Tonsil scissors
Tijeras para amígdalas
Forbici per tonsille

DEAN

11-305-17 - 11-307-17 17,0 cm, 6 3/4 "



11-309-19

Tonsillenschere
 Tonsil scissors
 Tijera para amígdalas
 Forbici per tonsille

GOOD

11-309-19 19,0 cm, 7 1/2"

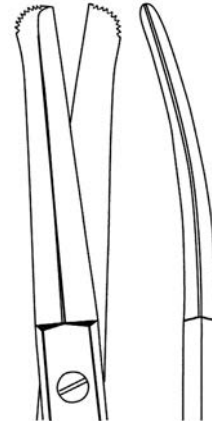
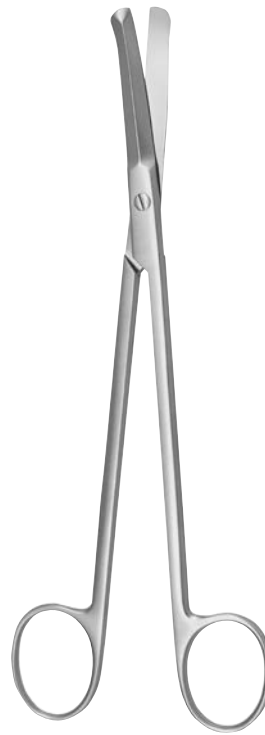

11-311-19



Tonsillenschere
 Tonsil scissors
 Tijera para amígdalas
 Forbici per tonsille

GOOD-SCHWEKENDIECK

11-311-19 19,0 cm, 7 1/2"

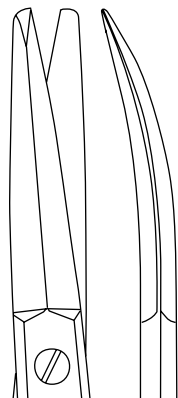
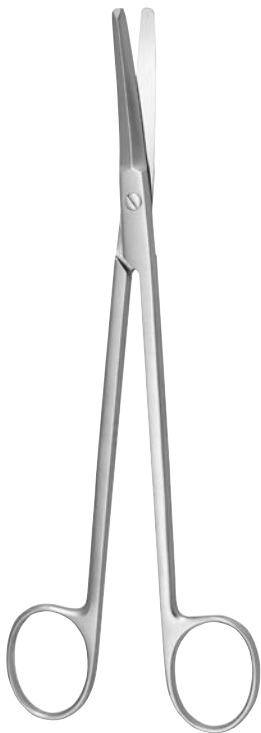

11-313-19

Gefäßschere
 Vascular scissors
 Tijera vasculares
 Forbici vascolari

POTTS-SMITH

11-313-19 19,0 cm, 7 1/2"

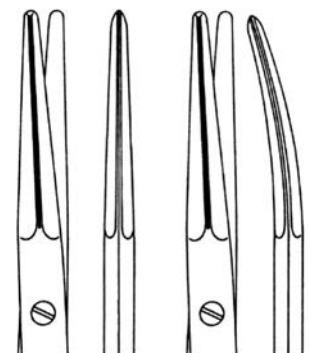

11-314-14
11-314-18

11-315-14
11-315-18

Face-lift Scheren
 Face-lift scissors
 Tijeras para Face-lift
 Forbici per Face-lift

KAHN

11-314-14 - 11-315-14 14,0 cm, 5 1/2"
11-314-18 - 11-315-18 18,0 cm, 7"



11-317-09

Face-lift Schere
Face-lift scissors
Tijera para Face-lift
Forbici per Face-lift

SALYER

11-317-09 9,5 cm, 3 3/4 "

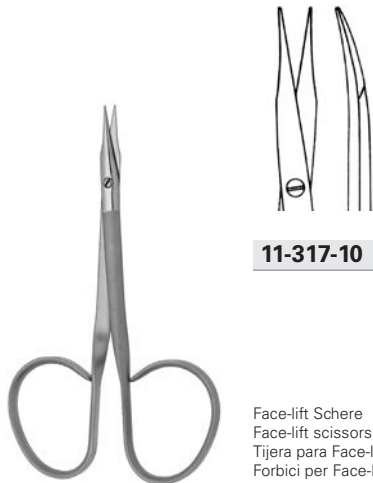

11-317-10

Face-lift Schere
Face-lift scissors
Tijera para Face-lift
Forbici per Face-lift

SALYER

11-317-10 10,0 cm, 4 "

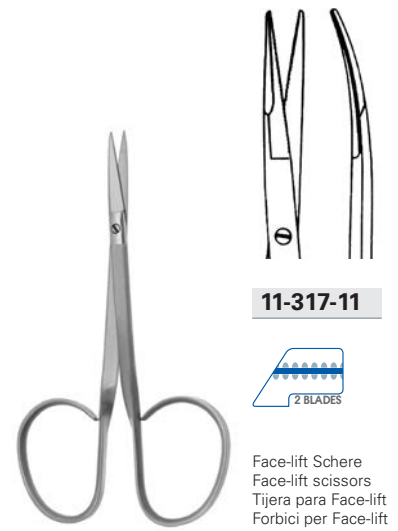

11-317-11

Face-lift Schere
Face-lift scissors
Tijera para Face-lift
Forbici per Face-lift

KAYE

11-317-11 11,0 cm, 4 3/8 "



11-319-13

Nasenschere
Nasal scissors
Tijera nasales
Forbici nasali

FOMON

11-319-13 13,0 cm, 5 1/8 "

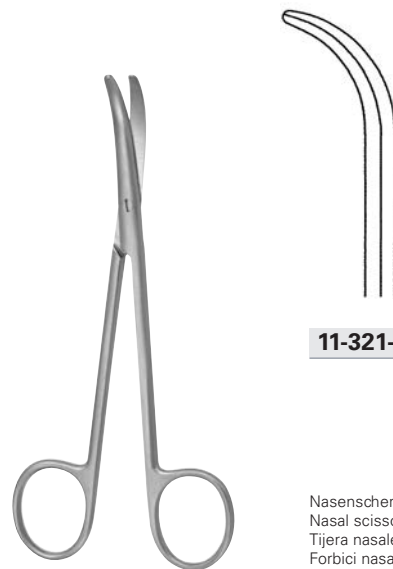

11-321-13

Nasenschere
Nasal scissors
Tijera nasales
Forbici nasali

FOMON

11-321-13 13,0 cm, 5 1/8 "

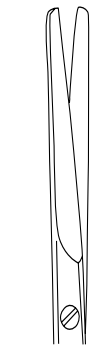

11-327-13

FOMON-FINO

11-327-13 13,0 cm, 5 1/8"



11-327-14

FOMON

11-327-14 13,0 cm, 5 1/8"



11-329-13

FOMON

11-329-13 13,0 cm, 5 1/8"

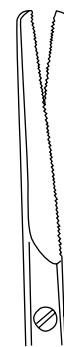

11-329-15



FOMON

11-329-15 15,0 cm, 6"

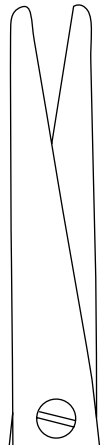

11-331-16

COTTLE

11-331-16 16,0 cm, 6 1/4"



11-333-17
11-335-18
11-333-20

HEYMANN

11-333-17	17,0 cm, 6 3/4"
11-335-18	18,0 cm, 7"
11-333-20	20,0 cm, 8"

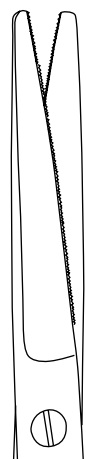

11-337-18



HEYMANN

11-337-18 18,0 cm, 7"

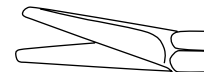

11-338-23

OLIVECRONA

11-338-23 23,0 cm, 9"

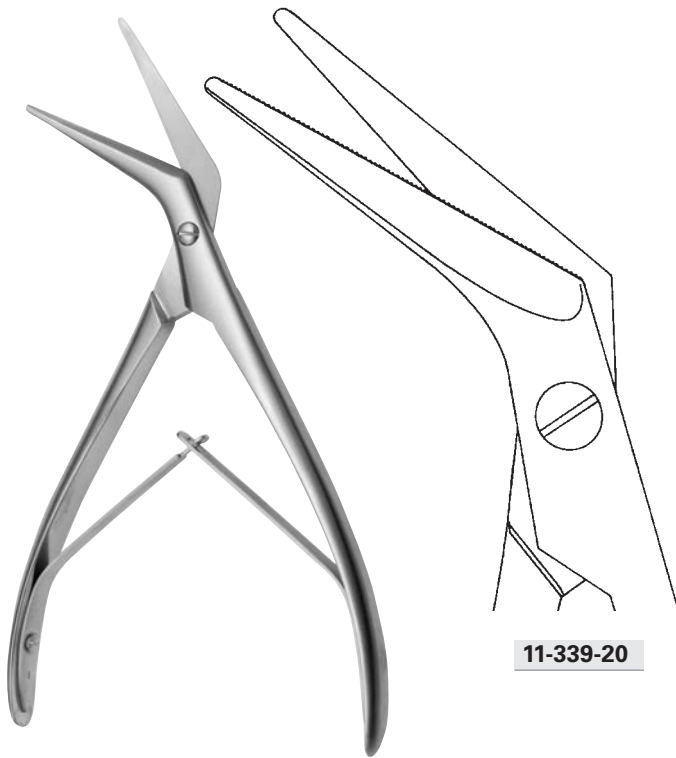

11-339-20

TESSIER

11-339-20 20,0 cm, 8 "



11-341-18

KNIGHT

11-341-18 18,0 cm, 7 "



11-343-11

FOMON

11-343-11 11,5 cm, 4 1/2 "



11-345-11

11-345-12

LANDOLT

11-345-11 - 11-345-12 12,0 cm, 4 3/4 "

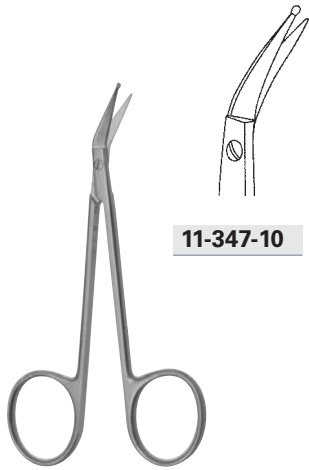

11-347-10

11-347-10 10,0 cm, 4"

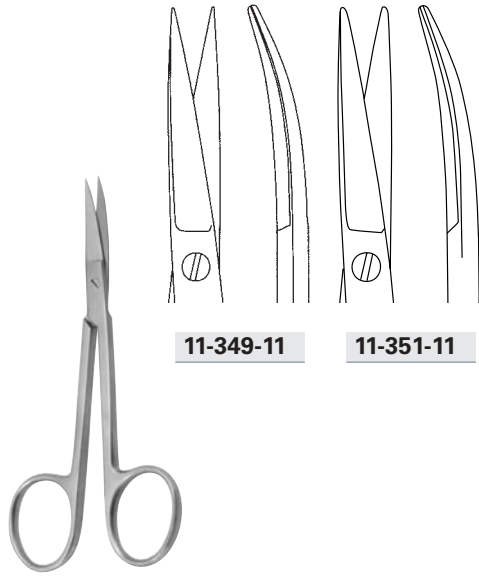

11-349-11

11-351-11

COTTLE-MASING

11-349-11 - 11-351-11 10,5 cm, 4 1/4"



11-355-12

COTTLE

11-355-12 11,5 cm, 4 1/2"

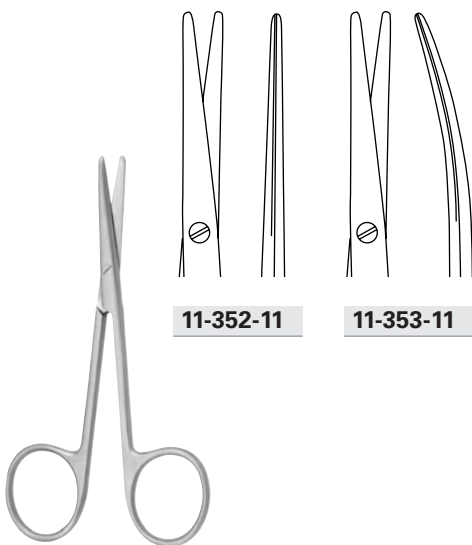

11-352-11

11-353-11

COTTLE-KNAPP

11-352-11 - 11-353-11 10,5 cm, 4 1/4"

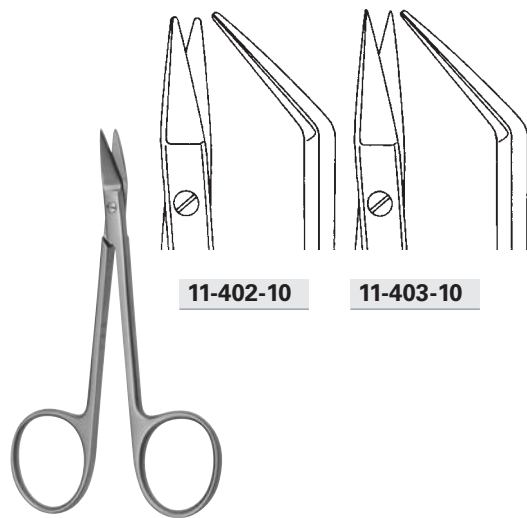

11-402-10

11-403-10

WILMER-WALTER

11-402-10 - 11-403-10 10,0 cm, 4"

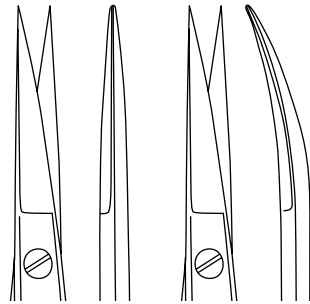

11-400-16
11-400-18

11-401-16
11-401-18

KELLY

11-400-16 - 11-401-16 16,0 cm, 6 ¼"
 11-400-18 - 11-401-18 18,0 cm, 7"

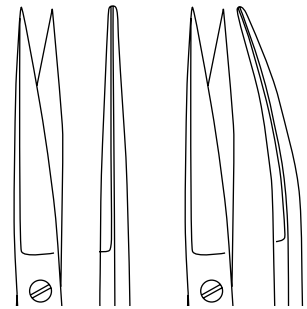

11-404-14
11-404-17

11-405-14
11-405-17

JOSEPH

11-404-14 - 11-405-14 14,0 cm, 5 ½"
 11-404-17 - 11-405-17 17,0 cm, 6 ¾"

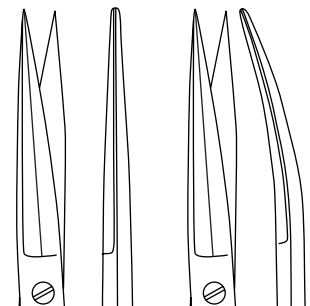

11-404-15

11-405-15

PECK-JOSEPH

11-404-15 - 11-405-15 14,5 cm, 5 ⅞"



11-407-11

CHADWICK

11-407-11 11,0 cm, 4 ⅜"

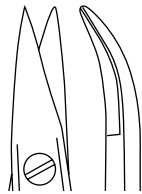

11-407-13

Zahnfleischschere
Gum scissors
Tijera para encías
Forbici per gengiva

QUINBY

11-407-13 13,0 cm, 5 1/8"

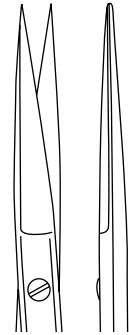
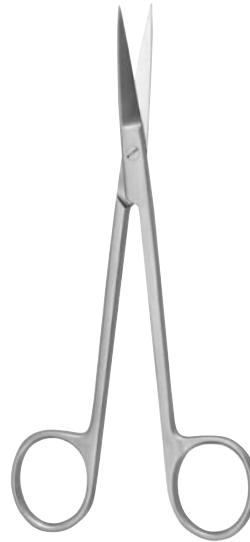

11-408-14

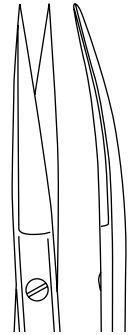

11-409-14

SANVENERO

11-408-14 - 11-409-14 14,0 cm, 5 1/2"

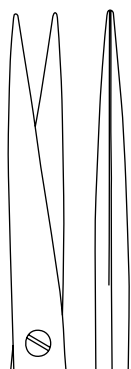

11-410-15

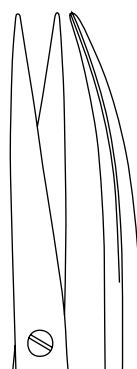

11-411-15

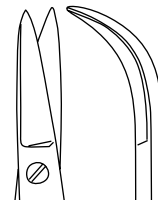

11-413-11

Zahnfleischschere
Gum scissors
Tijera para encías
Forbici per gengiva

LA GRANGE

11-413-11 11,0 cm, 4 3/8"

11-410-15 - 11-411-15 15,0 cm, 6"



11-416-13

11-417-13



Zahnfleischscheren
 Gum scissors
 Tijeras para encías
 Forbici per gengiva



11-417-12



Zahnfleischscheren
 Gum scissors
 Tijera para encías
 Forbici per gengiva

GOLDMANN-FOX

11-416-13 - 11-417-13 13,0 cm, 5 1/8"

GOLDMANN-FOX-S

11-417-12 13,0 cm, 5 1/8"

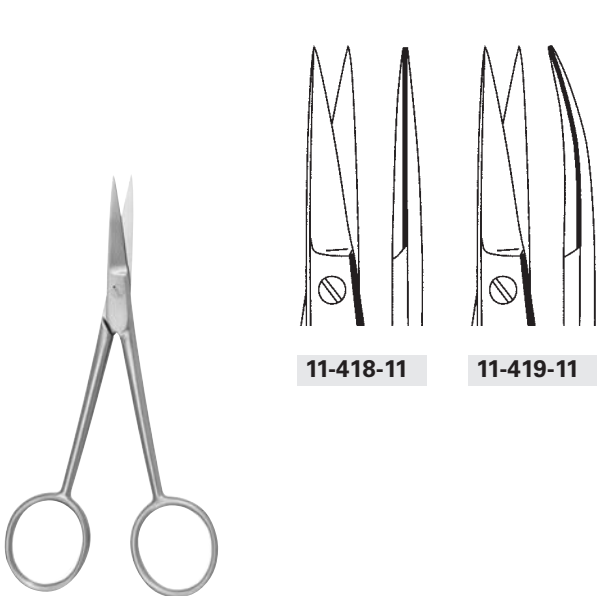

11-418-11

11-419-11

11-418-11 - 11-419-11 11,0 cm, 4 3/8"

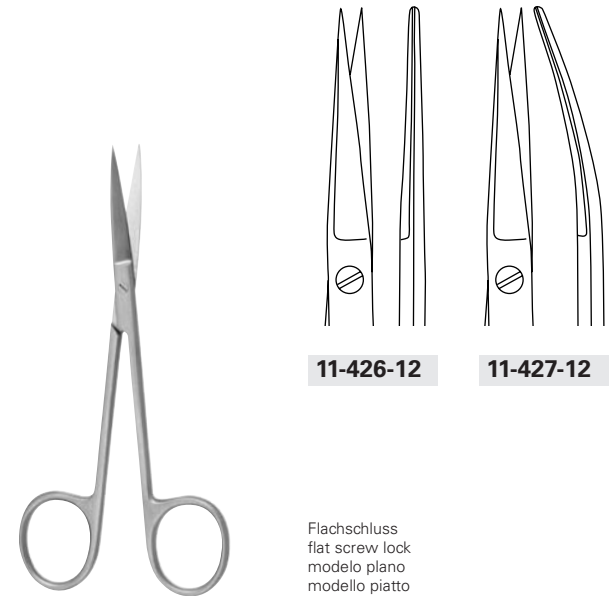

11-426-12

11-427-12

Flachschluss
 flat screw lock
 modelo plano
 modello piatto

WAGNER

11-426-12 - 11-427-12 12,0 cm, 4 3/4"



Fig. 1

11-420-12

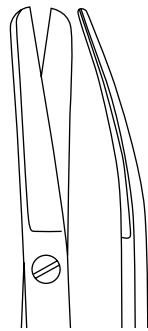

Fig. 1

11-421-12

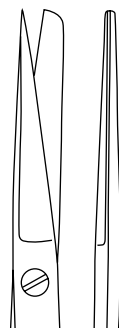

Fig. 2

11-422-12



Fig. 2

11-423-12



Fig. 3

11-424-12

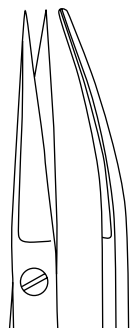

Fig. 3

11-425-12

WAGNER STANDARD

11-420-12 - 11-425-12 12,0 cm, 4 3/4"



11-428-11



11-429-11

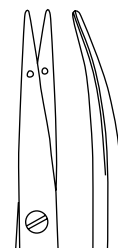

11-431-11
11-431-14

KILNER

11-428-11 - 11-429-11 11,0 cm, 4 3/8"

LITTLER

11-431-11 11,0 cm, 4 3/8"
11-431-14 14,0 cm, 5 1/2"



Fig. 1

11-432-10
11-432-11



Fig. 1

11-433-10
11-433-11



Fig. 3

11-434-10
11-434-11



Fig. 3

11-435-10
11-435-11

STEVENS

11-432-10 - 11-435-10 10,0 cm, 4 "
11-432-11 - 11-435-11 11,0 cm, 4 3/8 "



11-436-09
11-436-10
11-436-11

IRIS

11-436-09 9,0 cm, 3 1/2 "
11-436-10 10,0 cm, 4 "
11-436-11 11,0 cm, 4 3/8 "



11-437-09
11-437-10
11-437-11

IRIS

11-437-09 9,0 cm, 3 1/2 "
11-437-10 10,0 cm, 4 "
11-437-11 11,0 cm, 4 3/8 "

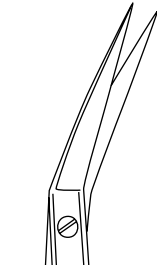

11-438-11



11-439-11



11-439-09

IRIS

11-438-11 - 11-439-11 11,0 cm, 4 $\frac{3}{8}$ "

O'BRIEN

11-439-09 9,0 cm, 3 $\frac{1}{2}$ "

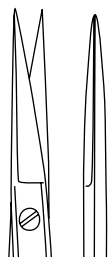

11-440-09
11-440-10
11-440-11
11-440-12



11-441-09
11-441-10
11-441-11
11-441-12

IRIS STANDARD

11-440-09 9,0 cm, 3 $\frac{1}{2}$ "
11-440-10 10,0 cm, 4 "
11-440-11 11,0 cm, 4 $\frac{3}{8}$ "
11-440-12 12,0 cm, 4 $\frac{3}{4}$ "

IRIS STANDARD

11-441-09 9,0 cm, 3 $\frac{1}{2}$ "
11-441-10 10,0 cm, 4 "
11-441-11 11,0 cm, 4 $\frac{3}{8}$ "
11-441-12 12,0 cm, 4 $\frac{3}{4}$ "



11-442-10
11-442-11

11-443-10
11-443-11

IRIS-FINO

11-442-10 - 11-443-10 10,0 cm, 4 "
 11-442-11 - 11-443-11 11,0 cm, 4 3/8 "

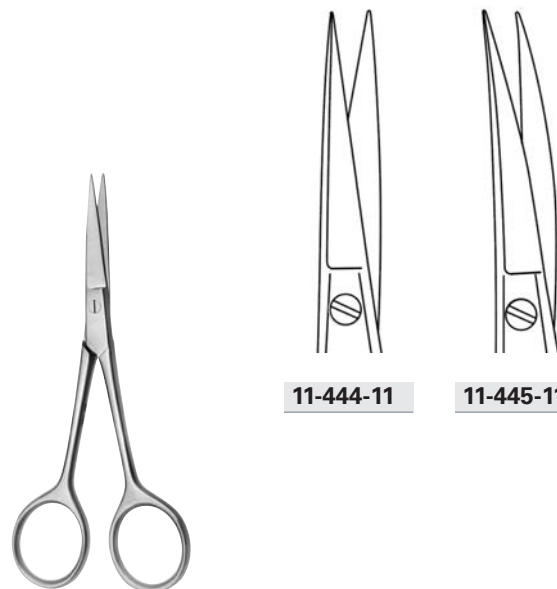

11-444-11

11-445-11

IRIS-ANATOMY

11-444-11 - 11-445-11 11,0 cm, 4 3/8 "



11-446-08
11-446-09

11-447-08
11-447-09

BONN

11-446-08 - 11-447-08 8,0 cm, 3 1/8 "
 11-446-09 - 11-447-09 9,0 cm, 3 1/2 "

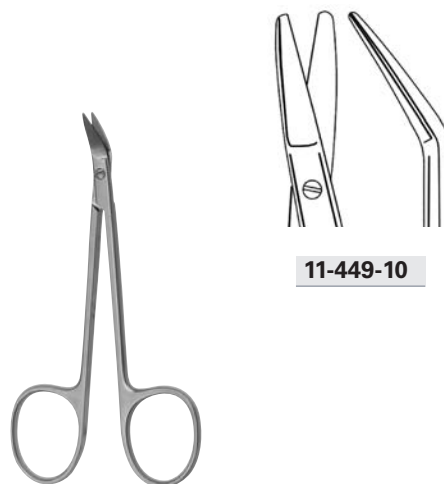

11-449-10

GRAEFE

11-449-10 9,5 cm, 3 3/4 "



RIBBON-STEVENS

11-450-10 - 11-453-10 9,5 cm, 3 3/4"

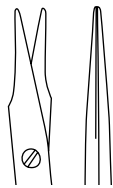

Fig. 1

11-450-10



Fig. 1

11-451-10



Fig. 3

11-452-10



Fig. 3

11-453-10



RIBBON-IRIS

11-454-10 - 11-457-10 10,0 cm, 4"

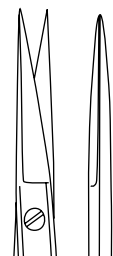

Fig. 1

11-454-10



Fig. 1

11-455-10

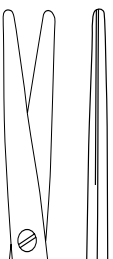

Fig. 3

11-456-10



Fig. 3

11-457-10



JABALEY

11-458-13 - 11-459-13 13,0 cm, 5 1/8"

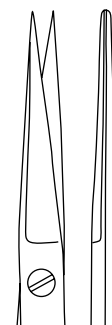

11-458-13

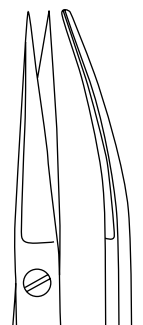

11-459-13

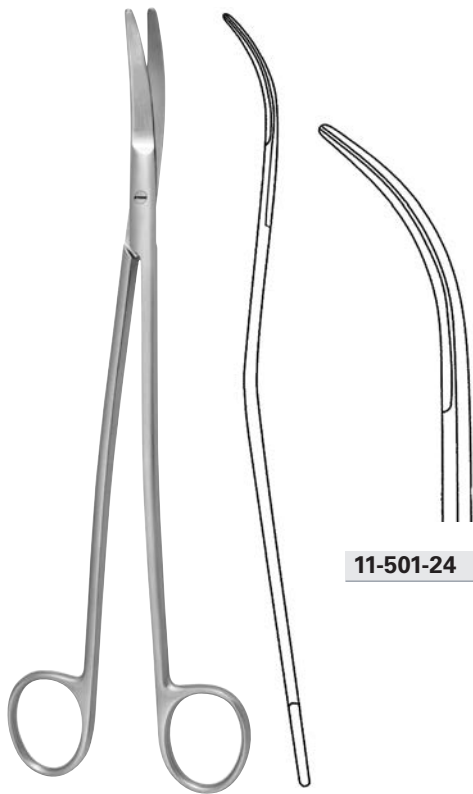

11-501-24

SATINSKY

11-501-24 24,0 cm, 9 1/2"



BOZEMANN

11-502-22 22,0 cm, 8 3/4"

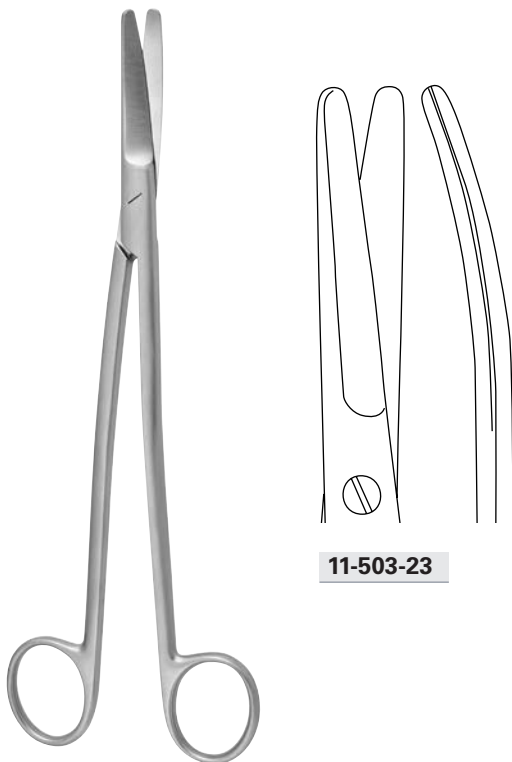

11-503-23

KLINKENBERGH-LOTH

11-503-23 23,0 cm, 9"

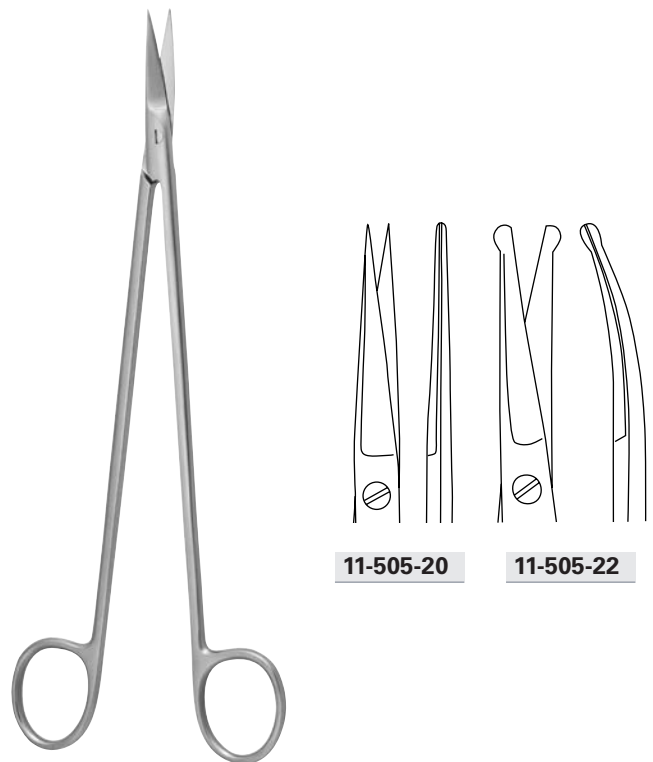

11-505-20

11-505-22

STRULLY

11-505-20 20,0 cm, 8"
 11-505-22 22,0 cm, 8 3/4"

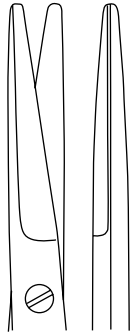

11-506-17



11-507-17

CHURCH

11-506-17 - 11-507-17 17,0 cm, 6 3/4"

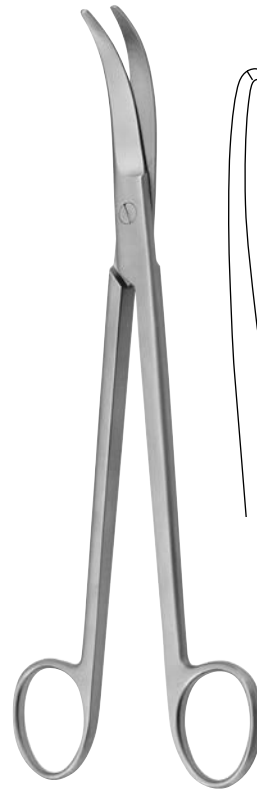

11-507-23

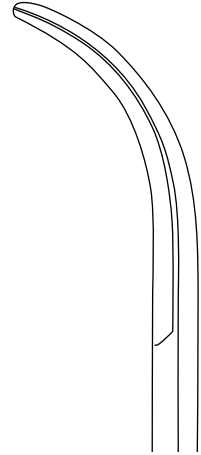

JORGENSON

11-507-23 23,0 cm, 9"

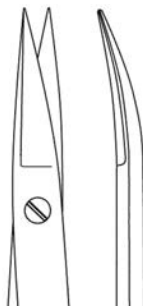
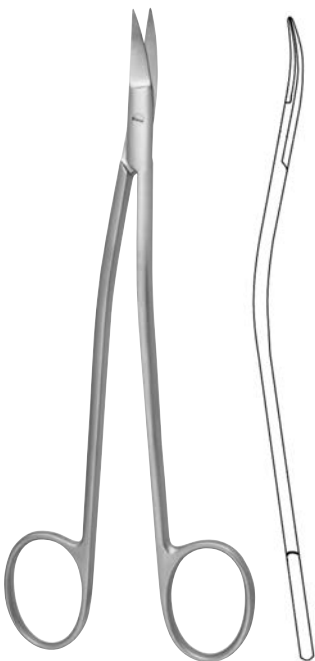

11-511-17

DANDY

11-511-17 17,0 cm, 6 3/4"

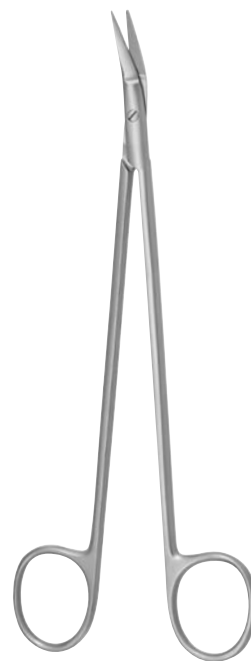

11-513-17

CLASSON

11-513-17 17,0 cm, 6 3/4"

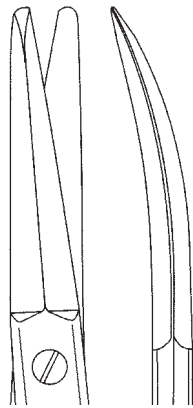

11-515-19

POTTS-SMITH

11-515-19 19,0 cm, 7 1/2"

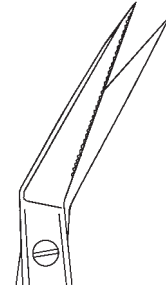
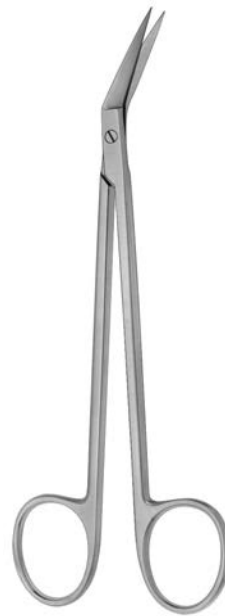

11-519-16



LOCKLIN

11-519-16 16,0 cm, 6 1/4"

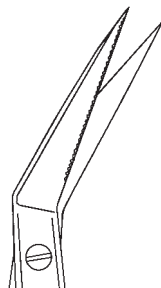

11-521-16



LOCKLIN

11-521-16 16,0 cm, 6 1/4"

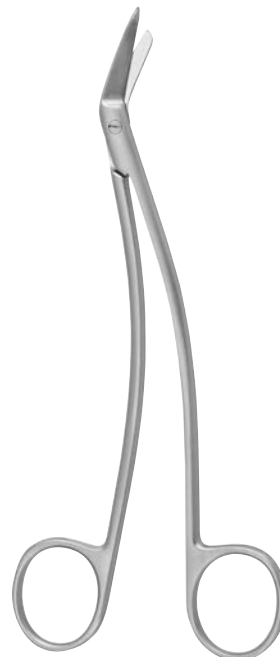

11-523-14
 11-523-17

SCHMIEDEN-TAYLOR

11-523-14 14,0 cm, 5 1/2"
 11-523-17 17,0 cm, 6 3/4"

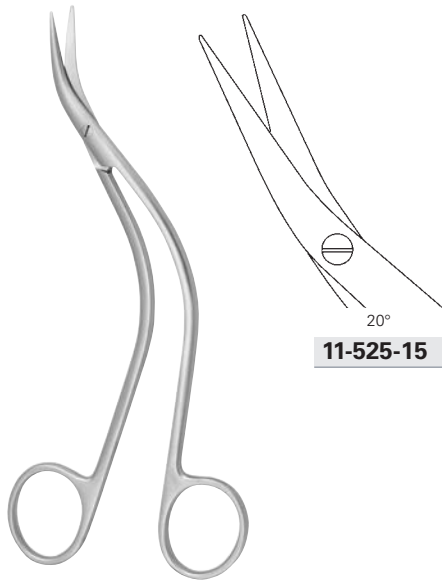

11-525-15

DE BAKEY

11-525-15 15,0 cm, 6 "

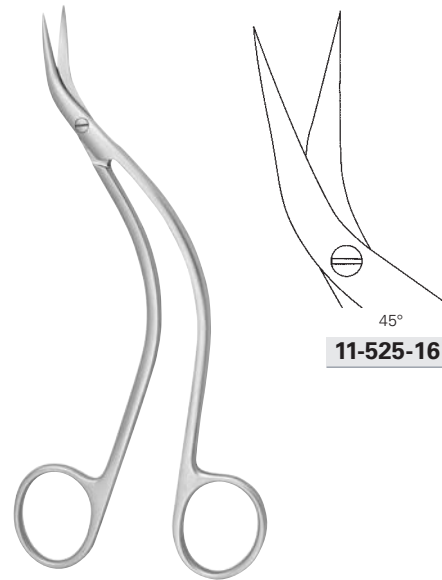

11-525-16

DE BAKEY

11-525-16 15,0 cm, 6 "

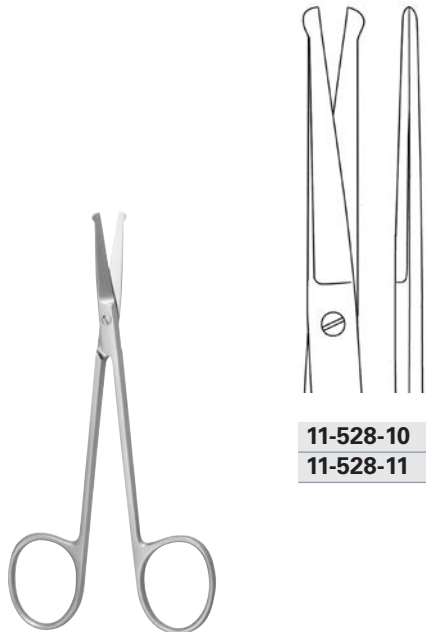

11-528-10
11-528-11

11-528-10 10,0 cm, 4 "

11-528-11 11,0 cm, 4 3/8 "

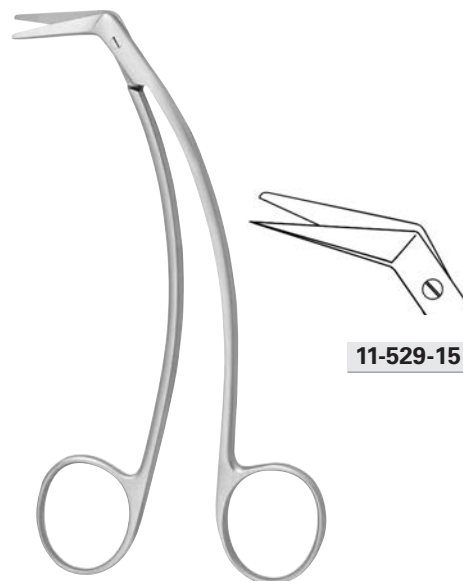

11-529-15

FAVALORO

11-529-15 15,0 cm, 6 "



11-530-11

11-530-11 11,0 cm, 4 3/8"



11-531-11

11-531-11 11,5 cm, 4 1/2"



11-532-14 14,5 cm, 5 3/4"

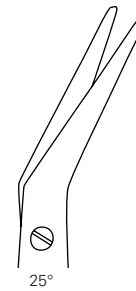
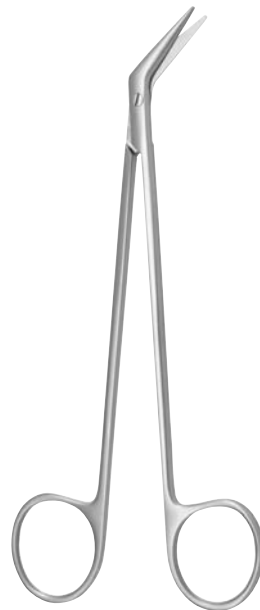

25°
 11-541-16
 11-541-19
 11-541-23

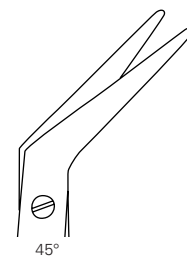

45°
 11-543-16
 11-543-19
 11-543-23

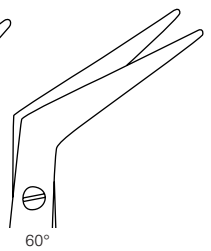

60°
 11-545-16
 11-545-19
 11-545-23

DE BAKEY

11-541-16 - 11-545-16 16,0 cm, 6 1/4"
 11-541-19 - 11-545-19 19,0 cm, 7 1/2"
 11-541-23 - 11-545-23 23,0 cm, 9"

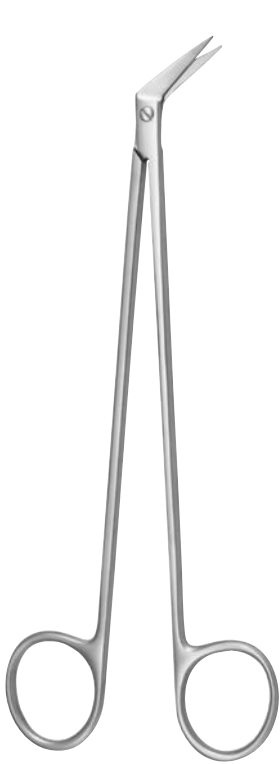

11-551-19

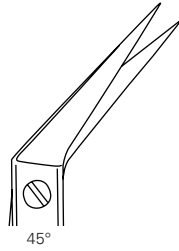

11-553-19

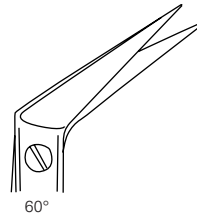

11-555-19



11-561-19

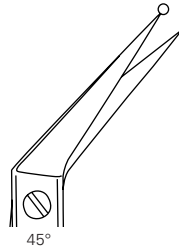

11-563-19

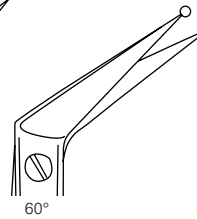

11-565-19

POTTS-SMITH

11-551-19 - 11-565-19 19,0 cm, 7 1/2"

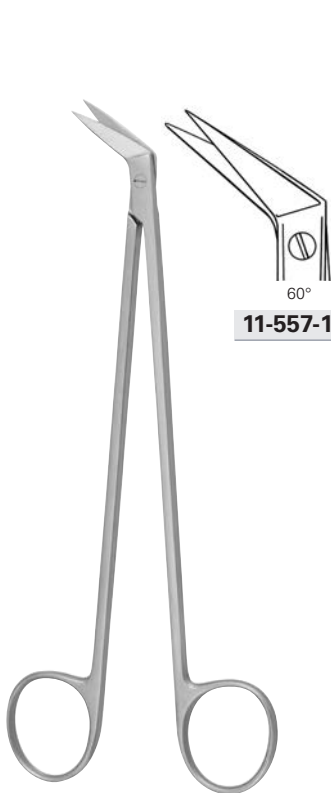

11-557-18

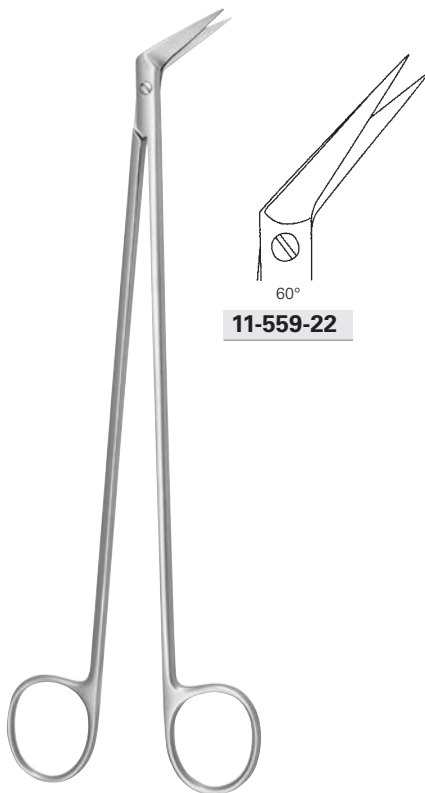

11-559-22



11-560-18

POTTS-SMITH

11-557-18 18,0 cm, 7"

POTTS-DE MARTEL

11-559-22 22,0 cm, 8 3/4"

POTTS-SMITH

11-560-18 18,0 cm, 7"

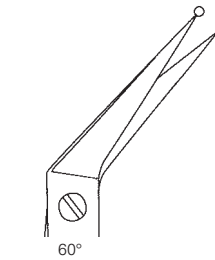
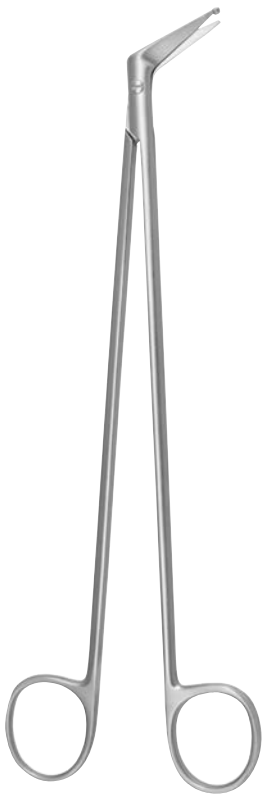

11-567-22

MILLS

11-567-22 22,0 cm, 8 3/4"

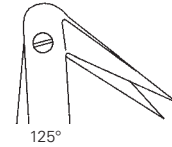

11-589-19

HEGEMANN-DIETRICH

11-589-19 19,0 cm, 7 1/2"

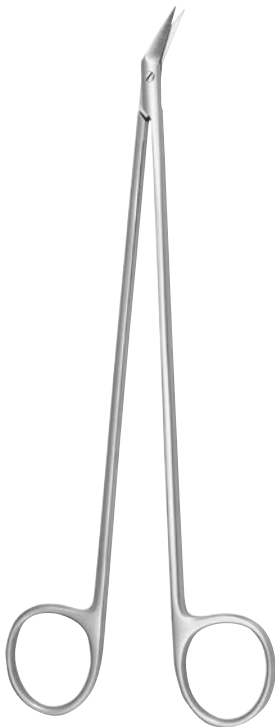

11-571-13
11-571-16
11-571-19

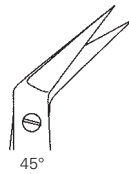

11-573-13
11-573-16
11-573-19

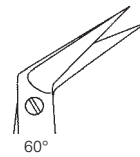

11-575-13
11-575-16
11-575-19

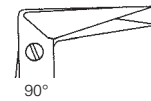

11-577-13
11-577-16
11-577-19

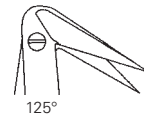

11-579-16
11-579-19

HEGEMANN-DIETRICH

11-571-13 - 11-577-13 13,0 cm, 5 1/8"
11-571-16 - 11-579-16 16,0 cm, 6 1/4"
11-571-19 - 11-579-19 19,0 cm, 7 1/2"

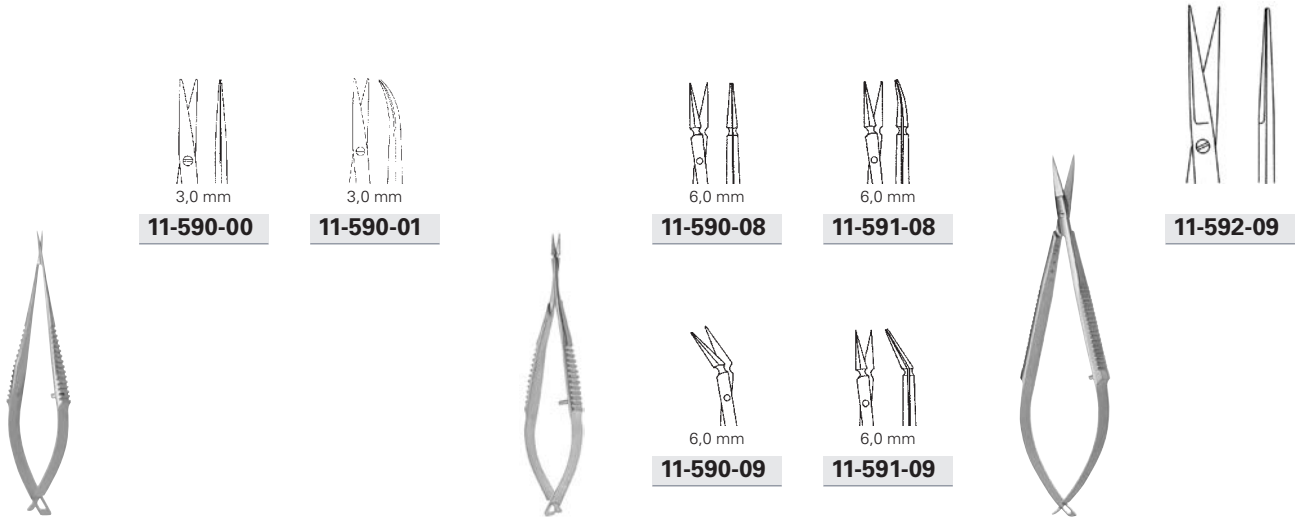

MINI-VANNAS

11-590-00 - 11-590-01 7,5 cm, 3 "

MINI-VANNAS

11-590-08 - 11-591-09 7,5 cm, 3 "

MC CLURE

11-592-09 9,5 cm, 3 3/4 "

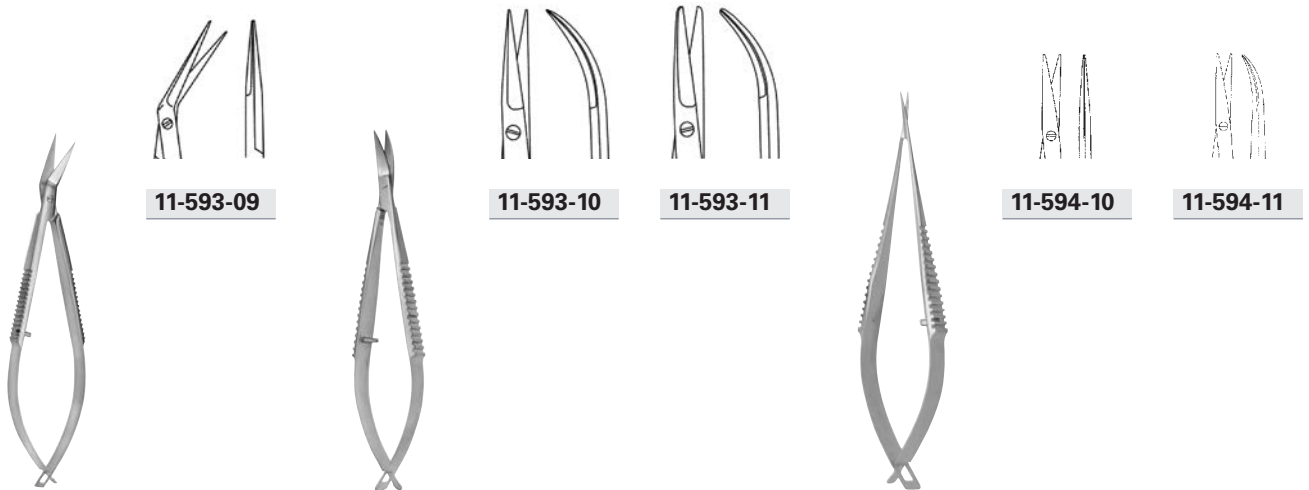

CASTROVIEJO

11-593-09 9,5 cm, 3 3/4 "

CASTROVIEJO

11-593-10 - 11-593-11 9,5 cm, 3 3/4 "

11-594-10 - 11-594-11 10,5 cm, 4 1/4 "

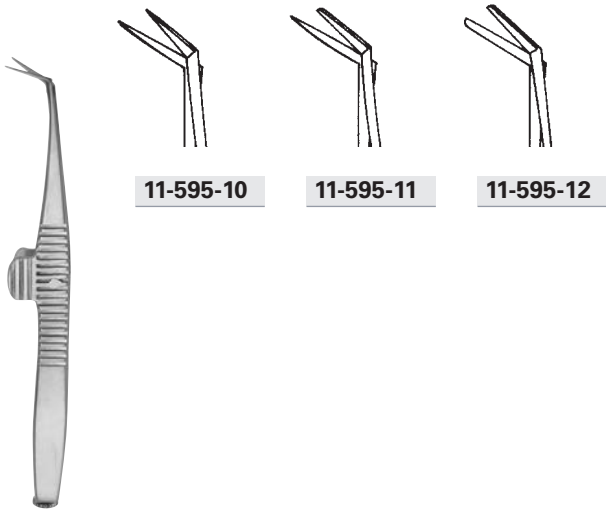

11-595-10

11-595-11

11-595-12

WECKER

11-595-10 - 11-595-12 11,5 cm, 4 3/8"

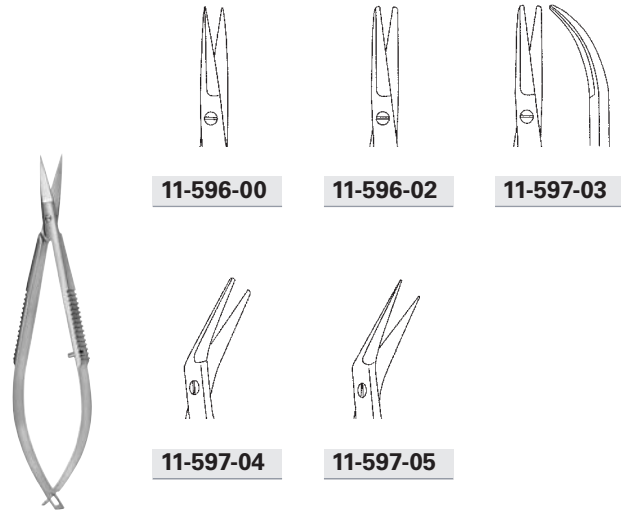

11-596-00

11-596-02

11-597-03

11-597-04

11-597-05

CASTROVIEJO

11-596-00 - 11-597-05 9,0 cm, 3 1/2"



11-596-10

CASTROVIEJO

11-596-10 11,0 cm, 4 3/8"



11-596-11

CASTROVIEJO

11-596-11 11,0 cm, 4 3/8"



11-596-12

CASTROVIEJO

11-596-12 11,5 cm, 4 1/2"



11-596-13



11-597-12



11-597-13



11-598-11



11-598-12



11-598-13

NOYES

11-596-13 - 11-597-13 12,5 cm, 5 "

NOYES

11-598-11 - 11-598-13 12,5 cm, 5 "



5,0 mm

11-598-05



7,0 mm

11-598-07



BARRAQUER

11-598-05 - 11-598-07 5,5 cm, 2 1/4 "

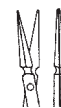

11-599-01



11-599-02



11-599-03

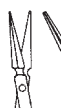

11-599-04

VANNAS MOD. TUEBINGEN

11-599-01 - 11-599-04 8,5 cm, 3 1/3 "

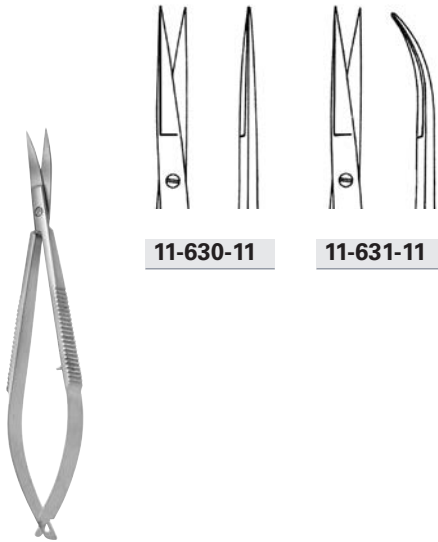

11-630-11

11-631-11

WESTCOTT

11-630-11 - 11-631-11 11,0 cm, 4 3/8"

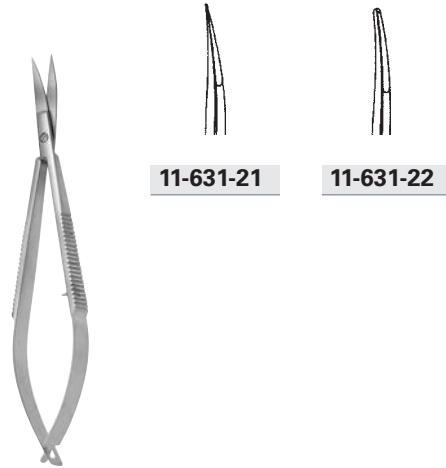

11-631-21

11-631-22

WESTCOTT

11-631-21 - 11-631-22 11,0 cm, 4 3/8"

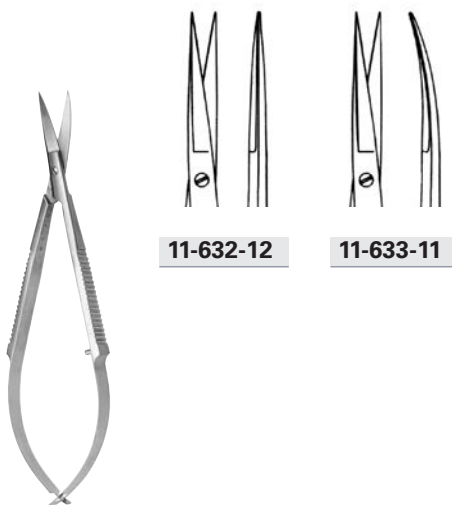

11-632-12

11-633-11

11-632-11 11,0 cm, 4 3/8"
 11-632-12 12,0 cm, 4 3/4"

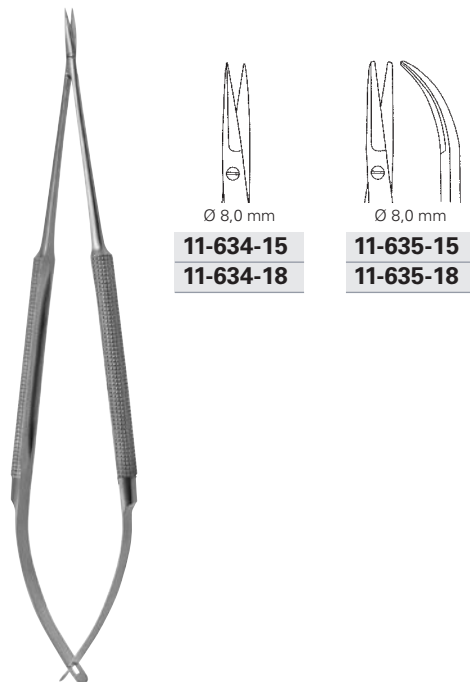

11-634-15

11-634-18

11-635-15

11-635-18

11-634-15 - 11-635-15 15,0 cm, 6"
 11-634-18 - 11-635-18 18,0 cm, 7"



11-635-01

KATZIN

11-635-01 10,0 cm, 4 "



11-635-02

KATZIN

11-635-02 10,0 cm, 4 "



11-635-03

KATZIN

11-635-03 11,0 cm, 4 3/8 "



11-635-04

KATZIN

11-635-04 11,0 cm, 4 3/8 "



11-635-05

KATZIN-BARRAQUER

11-635-05 10,0 cm, 4 "



11-635-06

KATZIN-BARRAQUER

11-635-06 10,0 cm, 4 "



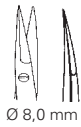

11-687-18

HEPP-SCHIEDEL

11-687-18 18,0 cm, 7 "



11-689-14
 11-689-16

GOMEL

11-689-14 14,0 cm, 5 1/2 "
 11-689-16 16,0 cm, 6 1/4 "



11-691-14
 11-691-16

HEPP-SCHIEDEL

11-691-14 14,0 cm, 5 1/2 "
 11-691-16 16,0 cm, 6 1/4 "

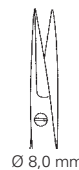

11-696-14

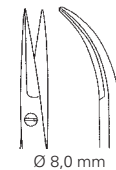

11-697-14

11-696-14 - 11-697-14 14,5 cm, 5 3/4 "



11



Mikro Instrumente

Micro Instruments

Instrumentos de micro

Strumentario micro

Fordern Sie unser Spezialprospekt an
Please ask for our special catalogue
No duden pedirnos más catálogos especiales
Chiedete i nostri cataloghi speciali



SPENCER-FINO

11-699-11 11,0 cm, 4 $\frac{3}{8}$ ''



SPENCER

11-700-09	9,0 cm, 3 $\frac{1}{2}$ ''
11-700-11	11,0 cm, 4 $\frac{3}{8}$ ''
11-700-13	12,5 cm, 5''



SPENCER

11-701-11 11,0 cm, 4 $\frac{3}{8}$ ''



SHORTBENT

11-703-09 9,0 cm, 3 $\frac{1}{2}$ ''



LOCKLIN

11-703-15 15,0 cm, 6''



NORTHBENT

11-705-13 13,0 cm, 5 $\frac{1}{8}$ ''



11-706-14

LITTAUER

11-706-14 14,0 cm, 5 1/2"



11-707-11
 11-707-14
 11-707-18

LITTLER

11-707-11	11,0 cm, 4 3/8"
11-707-14	14,0 cm, 5 1/2"
11-707-18	18,0 cm, 7"



11-708-14
 11-708-18

BUCK

11-708-14	14,0 cm, 5 1/2"
11-708-18	18,0 cm, 7"



11-710-12

EISELSBERG

11-710-12 12,0 cm, 4 3/4"

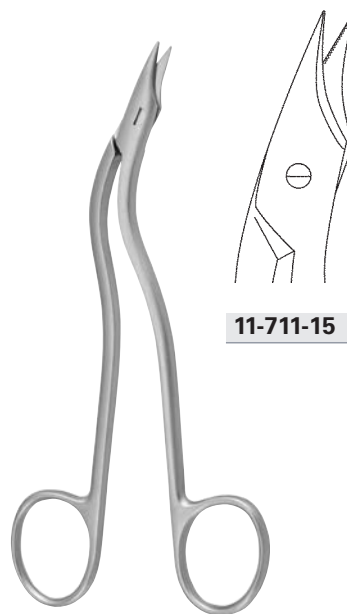

11-711-15

HEATH

11-711-15 15,0 cm, 6"



SCHOEMAKER-LOTH

11-712-12 12,0 cm, 4 3/4"

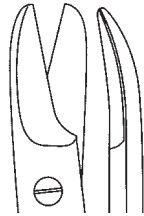

11-715-10

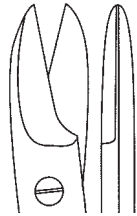

11-716-10

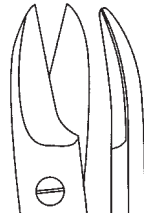

11-717-10

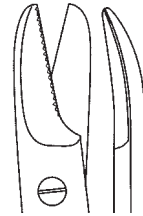

11-715-12

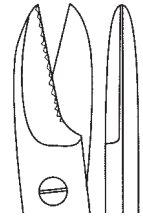

11-716-12

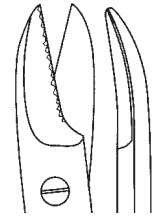

11-717-12

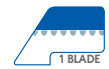

BEEBEE

11-715-10 - 11-717-10 10,0 cm, 4 "
11-715-12 - 11-717-12 12,0 cm, 4 3/4 "

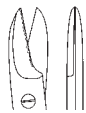

11-719-12

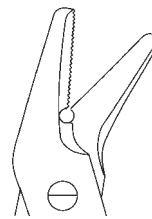
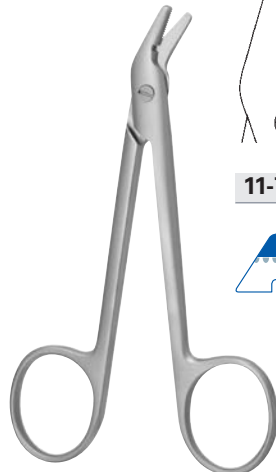

11-721-12



11-722-12

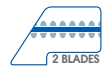

GUILFORD-WRIGHT

11-719-12 10,0 cm, 4 "

UNIVERSAL

11-721-12 12,0 cm, 4 3/4 "

HARVEY

11-722-12 12,0 cm, 4 3/4 "



11



SUPERCUT Scheren

SUPERCUT scissors

Tijeras SUPERCUT

Forbici SUPERCUT

Kennzeichen: goldene Schraube
Characteristic: golden screw
Característica: tornillo dorado
Caratteristica: vite dorata

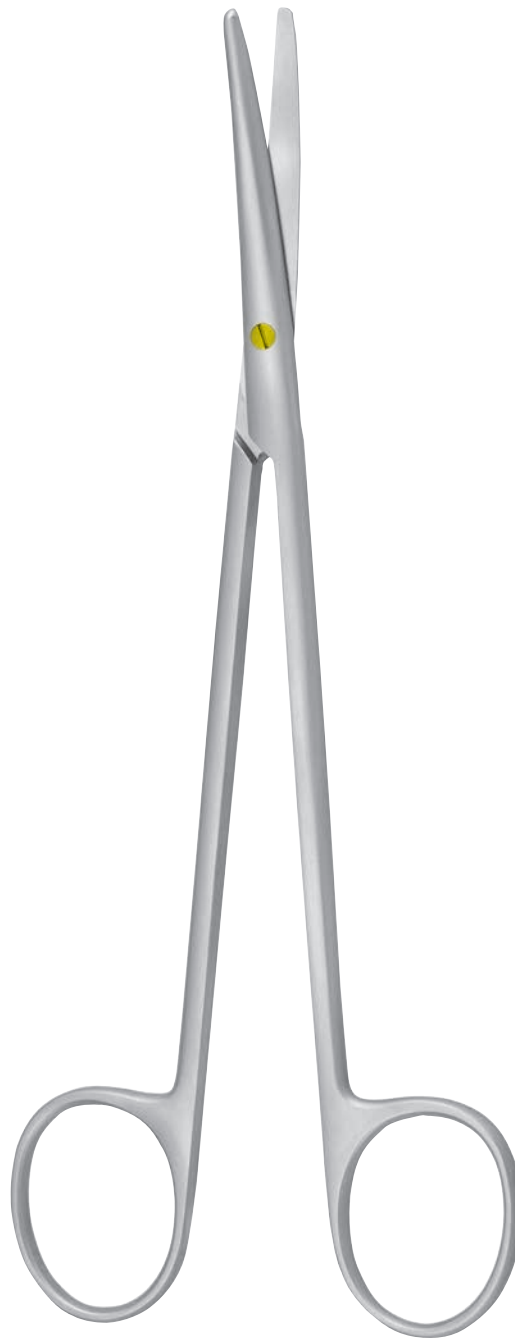

Schneidegeometrie
Cutting geometry
Geometría del corte
Geometria di taglio

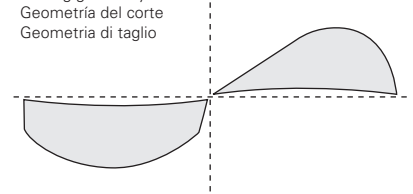

- Bei SUPERCUT Scheren hat ein Blatt die Schneidegeometrie eines Messers, was einen mühelosen, messerartigen und glatten Schnitt ermöglicht.
- Die Mikroverzahnung am anderen Scherenblatt verhindert das Abgleiten des Gewebes.
- SUPERCUT Scissors have one razor blade which allows an easy and clean cut.
- The micro serration at the opposite blade prevents sliding off the tissue.
- Las tijeras SUPERCUT tienen una hoja geométrica cortante, lo que posibilita un corte liso y sin esfuerzo en el tejido.
- El microdentado opuesto a la hoja lisa disminuye el deslizamiento del tejido.
- Le forbici SUPERCUT hanno una lama con sezione a coltello. Questo rende facile anche il taglio del tessuto meno delicato.
- La microdentellatura nell'altra lama garantisce una presa sicura del tessuto da tagliare.



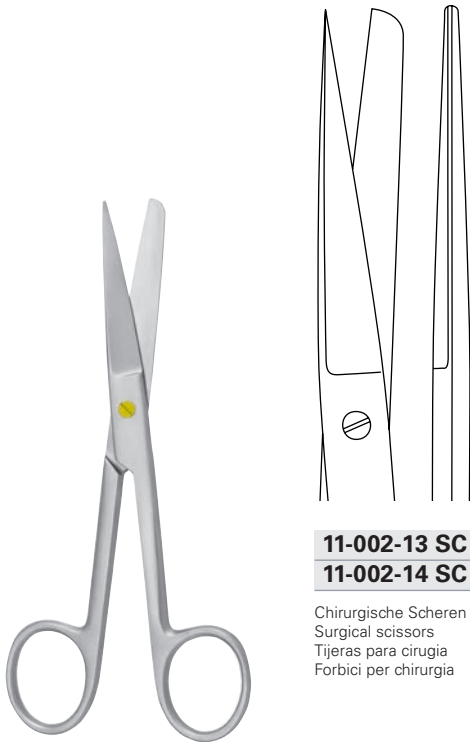

11-002-13 SC
11-002-14 SC

Chirurgische Scheren
 Surgical scissors
 Tijeras para cirugía
 Forbici per chirurgia

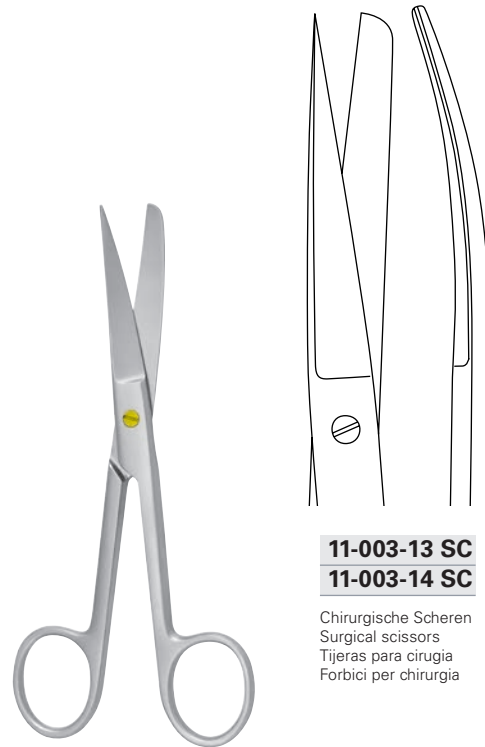

11-003-13 SC
11-003-14 SC

Chirurgische Scheren
 Surgical scissors
 Tijeras para cirugía
 Forbici per chirurgia

STANDARD Fig. 2

11-002-13 SC 13,0 cm, 5 1/8"
11-002-14 SC 14,0 cm, 5 1/2"



STANDARD Fig. 2

11-003-13 SC 13,0 cm, 5 1/8"
11-003-14 SC 14,0 cm, 5 1/2"

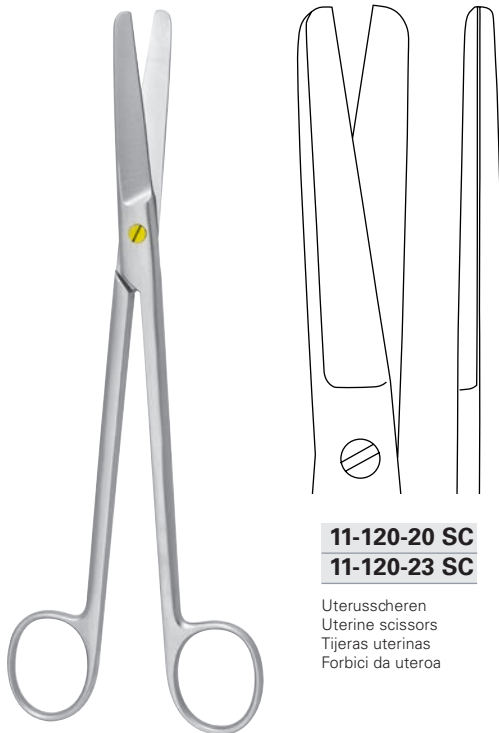

11-120-20 SC
11-120-23 SC

Uterusscheren
 Uterine scissors
 Tijeras uterinas
 Forbici da uteroa



11-121-20 SC
11-121-23 SC

Uterusscheren
 Uterine scissors
 Tijeras uterinas
 Forbici da uteroa

SIMS

11-120-20 SC - 11-121-20 SC 20,0 cm, 8"
11-120-23 SC - 11-121-23 SC 23,0 cm, 9"



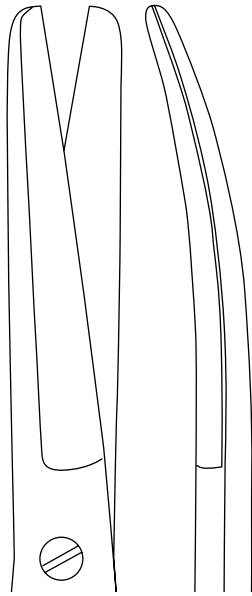

11-127-24 SC

Uterusschere
Uterine scissors
Tijera uterinas
Forbici da uteroa

SIMS-SIEBOLD-S

11-127-24 SC 24,0 cm, 9 1/2 "

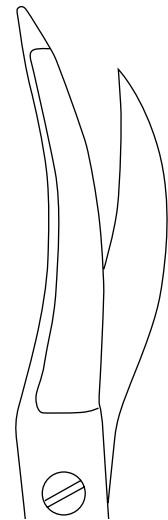

11-141-18 SC

Damm Schere (Episiotomie)
Perineum scissors (Episiotomy)
Tijeras para perineo (episiotomia)
Forbici per perineo (episiotomia)

WALDMANN

11-141-18 SC 18,0 cm, 7 "

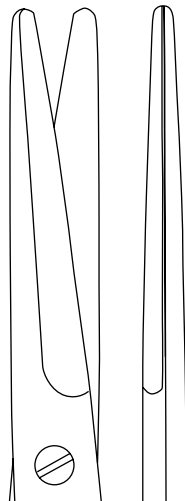

11-160-14 SC
11-160-15 SC
11-160-17 SC
11-160-23 SC

Chirurgische Scheren
Surgical scissors
Tijeras para cirugia
Forbici per chirurgia

MAYO

11-160-14 SC 14,0 cm, 5 1/2 "
11-160-15 SC 15,0 cm, 6 "
11-160-17 SC 17,0 cm, 6 3/4 "
11-160-23 SC 23,0 cm, 9 "

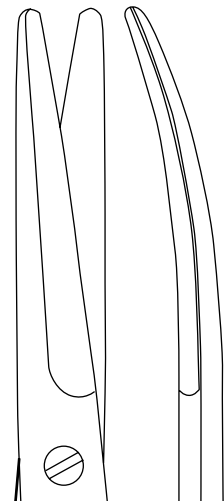

11-161-14 SC
11-161-15 SC
11-161-17 SC
11-161-23 SC

Chirurgische Scheren
Surgical scissors
Tijeras para cirugia
Forbici per chirurgia

MAYO

11-161-14 SC 14,0 cm, 5 1/2 "
11-161-15 SC 15,0 cm, 6 "
11-161-17 SC 17,0 cm, 6 3/4 "
11-161-23 SC 23,0 cm, 9 "



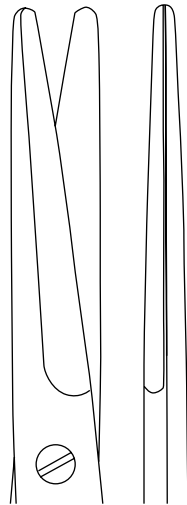

11-166-22 SC

Chirurgische Schere
 Surgical scissors
 Tijera para cirugía
 Forbici per chirurgia

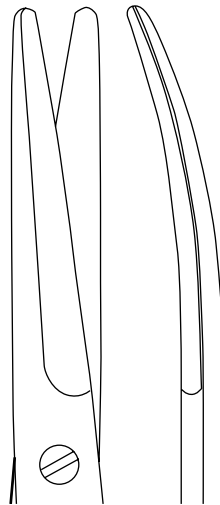

11-167-22 SC

Chirurgische Schere
 Surgical scissors
 Tijera para cirugía
 Forbici per chirurgia

MAYO-HARRINGTON

11-166-22 SC - 11-167-22 SC 22,0 cm, 8 ¾"

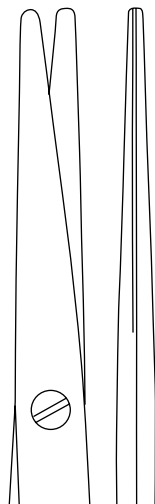

11-170-15 SC
11-170-17 SC

Chirurgische Scheren
 Surgical scissors
 Tijeras para cirugía
 Forbici per chirurgia



11-171-15 SC
11-171-17 SC

Chirurgische Scheren
 Surgical scissors
 Tijeras para cirugía
 Forbici per chirurgia

MAYO-STILLE

11-170-15 SC 15,0 cm, 6"
11-170-17 SC 17,0 cm, 6 ¾"



MAYO-STILLE

11-171-15 SC 15,0 cm, 6"
11-171-17 SC 17,0 cm, 6 ¾"



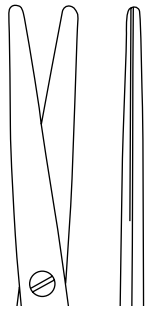
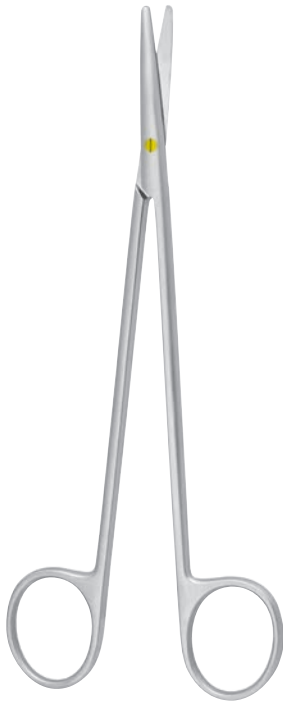

Präparierscheren
Dissecting scissors
Tijeras des disección
Forbici per dissezione



METZENBAUM

11-200-14 SC	14,0 cm, 5 1/2 "
11-200-18 SC	18,0 cm, 7 "
11-200-20 SC	20,0 cm, 8 "
11-200-23 SC	23,0 cm, 9 1/2 "
11-200-25 SC	25,0 cm, 9 3/4 "
11-200-30 SC	30,0 cm, 11 3/4 "

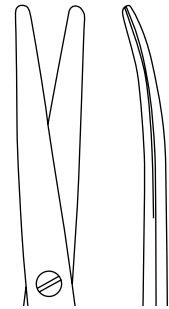

Präparierscheren
Dissecting scissors
Tijeras des disección
Forbici per dissezione



METZENBAUM

11-201-14 SC	14,0 cm, 5 1/2 "
11-201-18 SC	18,0 cm, 7 "
11-201-20 SC	20,0 cm, 8 "
11-201-23 SC	23,0 cm, 9 1/2 "
11-201-25 SC	25,0 cm, 9 3/4 "
11-201-30 SC	30,0 cm, 11 3/4 "

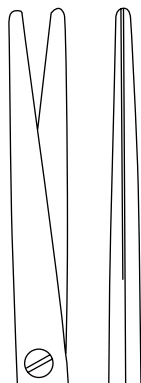

Präparierscheren
Dissecting scissors
Tijeras des disección
Forbici per dissezione



METZENBAUM-FINO

11-210-12 SC	12,0 cm, 4 3/4 "
11-210-14 SC	14,0 cm, 5 1/2 "
11-210-18 SC	18,0 cm, 7 "
11-210-20 SC	20,0 cm, 8 "
11-210-23 SC	23,0 cm, 9 1/2 "



Präparierscheren
Dissecting scissors
Tijeras des disección
Forbici per dissezione



METZENBAUM-FINO

11-211-12 SC	12,0 cm, 4 3/4 "
11-211-14 SC	14,0 cm, 5 1/2 "
11-211-18 SC	18,0 cm, 7 "
11-211-20 SC	20,0 cm, 8 "
11-211-23 SC	23,0 cm, 9 1/2 "

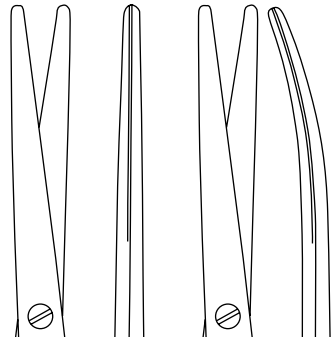

11-228-11 SC

11-229-11 SC



Präparierscheren
 Dissecting scissors
 Tijeras des disección
 Forbici per dissezione

METZENBAUM-BABY

11-228-11 SC - 11-229-11 SC 11,0 cm, 4 3/8 "

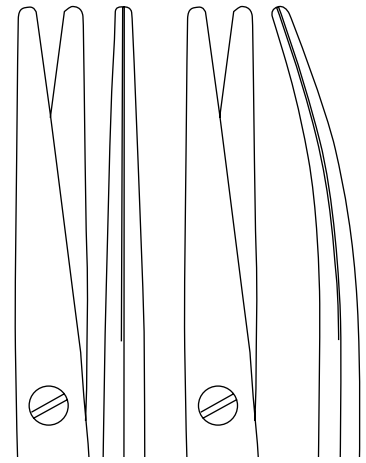

11-230-16 SC

11-231-16 SC



Präparierscheren
 Dissecting scissors
 Tijeras des disección
 Forbici per dissezione

LEXER

11-230-16 SC - 11-231-16 SC 16,0 cm, 6 1/4 "



11-245-12 SC

Präparierscheren
 Dissecting scissors
 Tijeras des disección
 Forbici per dissezione

KILNER (RAGNELL)

11-245-12 SC 12,0 cm, 4 3/4 "



11-247-15 SC

Präparierscheren
 Dissecting scissors
 Tijeras des disección
 Forbici per dissezione

JAMESON

11-247-15 SC 15,0 cm, 6 "



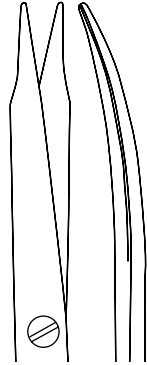

11-249-13 SC
11-249-15 SC
11-249-18 SC

Präparierscheren
Dissecting scissors
Tijeras des disección
Forbici per dissezione

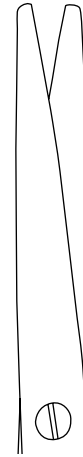

11-335-18 SC

Nasenschere
Nasal scissors
Tijera nasales
Forbici nasali

REYNOLDS

11-249-13 SC	13,0 cm, 5 1/8"
11-249-15 SC	15,0 cm, 6"
11-249-18 SC	18,0 cm, 7"



HEYMANN

11-335-18 SC 18,0 cm, 7"

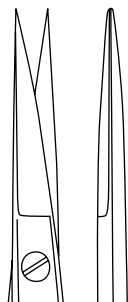

11-400-16 SC



Feine chirurgische Scheren
Delicate surgical scissors
Tijeras finas para cirugía
Forbici fine per chirurgia



11-401-16 SC



11-433-11 SC

Feine chirurgische Schere
Delicate surgical scissors
Tijera finas para cirugía
Forbici fine per chirurgia

KELLY

11-400-16 SC - 11-401-16 SC 16,0 cm, 6 1/4"

STEVENS

11-433-11 SC 11,0 cm, 4 3/8"



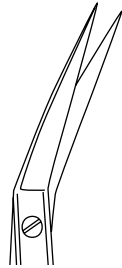

11-438-11 SC

Feine chirurgische Schere
 Delicate surgical scissors
 Tijera finas para cirugía
 Forbici fine per chirurgia

IRIS

11-438-11 SC 11,0 cm, 4 $\frac{3}{8}$ "



11-440-09 SC
11-440-11 SC

Feine chirurgische Scheren
 Delicate surgical scissors
 Tijeras finas para cirugía
 Forbici fine per chirurgia

IRIS

11-440-09 SC 9,0 cm, 3 $\frac{1}{2}$ "

11-440-11 SC 11,0 cm, 4 $\frac{3}{8}$ "

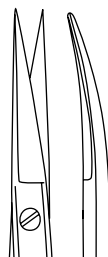

11-441-09 SC
11-441-11 SC

Feine chirurgische Scheren
 Delicate surgical scissors
 Tijeras finas para cirugía
 Forbici fine per chirurgia

IRIS

11-441-09 SC 9,0 cm, 3 $\frac{1}{2}$ "

11-441-11 SC 11,0 cm, 4 $\frac{3}{8}$ "



11-458-13 SC

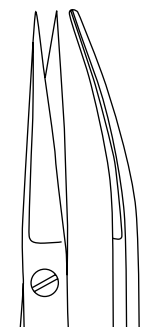

11-459-13 SC



Feine chirurgische Scheren
 Delicate surgical scissors
 Tijeras finas para cirugía
 Forbici fine per chirurgia

JABALEY

11-458-13 SC - 11-459-13 SC 13,0 cm, 5 $\frac{1}{8}$ "

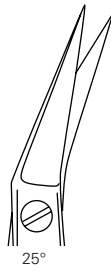
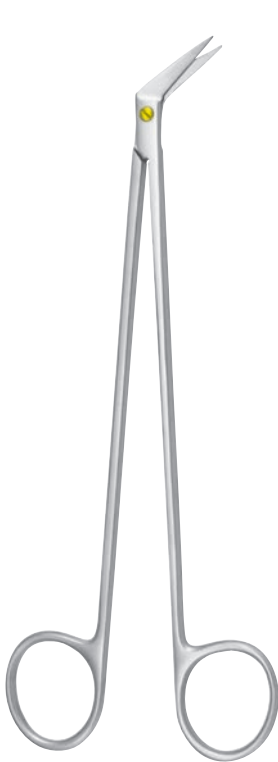

11-551-19 SC

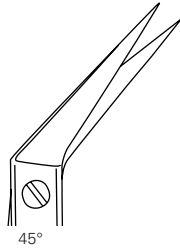

11-553-19 SC

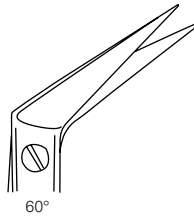

11-555-19 SC



Gefäßscheren
Vascular scissors
Tijeras vasculares
Forbici vascolari

POTTS-SMITH

11-551-19 SC - 11-555-19 SC 19,0 cm, 7 1/2"

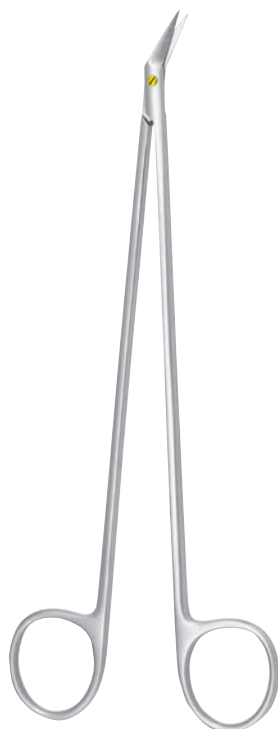

11-571-19 SC

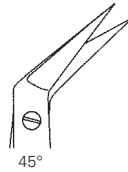

11-573-19 SC

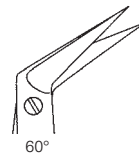

11-575-19 SC

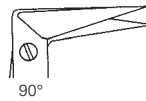

11-577-19 SC

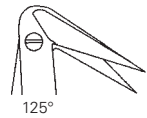

11-579-19 SC



Gefäßscheren
Vascular scissors
Tijeras vasculares
Forbici vascolari

HEGEMANN-DIETRICH

11-571-19 - 11-579-19 SC 19,0 cm, 7 1/2"



12



Scheren mit
Hartmetallschneiden

Scissors with
tungsten carbide edges

Tijeras con filos
de carburo tungsteno

Forbici con lame
in carburo i tungsteno

Kennzeichnung: goldene Ringe
Characteristic: golden rings
Característica: mangos dorados
Caratteristica: anelli dorata



Ausführungen | Specification
Especificación | Specifica

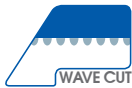

1 Schneide gezahnt
1 serrated blade
1 hoja dentada
1 lama dentata

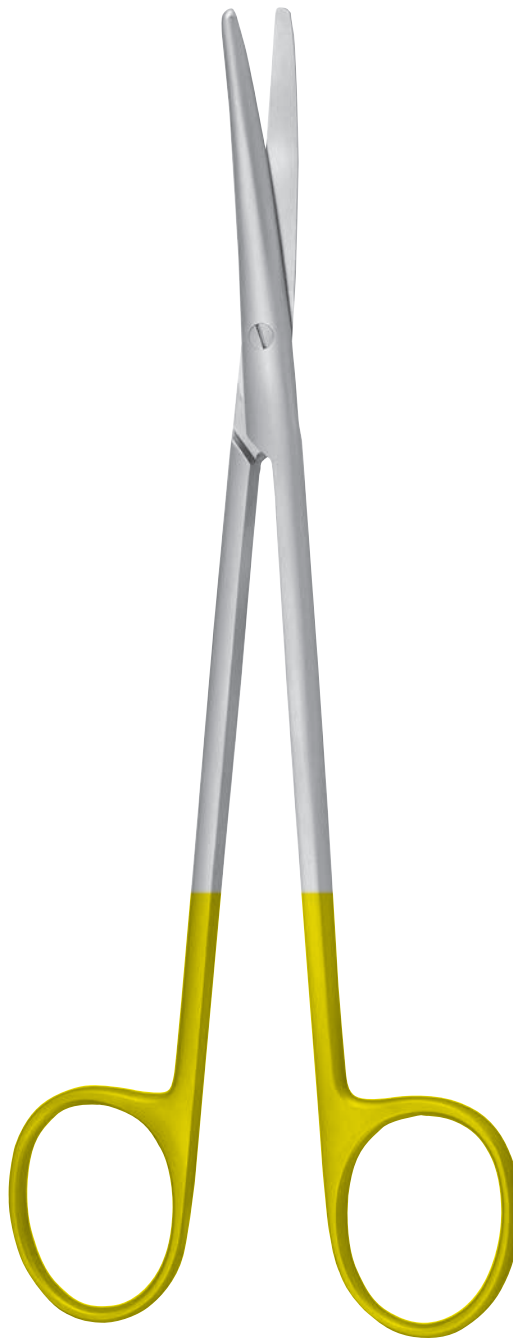

Schneidegeometrie
Cutting geometry
Geometría del corte
Geometria di taglio

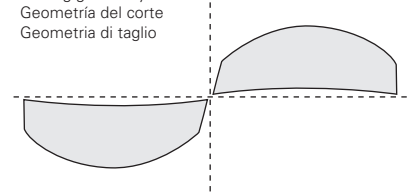

- Aufgeschweißte Hartmetallschneiden, daher keine zur Korrosion neigende Lötnaht
- Dauerhaft scharfer Schnitt
- Gleichmäßiger, weicher Gang
- Welded tungsten carbide cutting edges, therefore no seam tending to corrosion
- Durable sharp cutting edge
- Regular and smooth function
- Filos de carburo de tungsteno soldados, por eso sin soldadura tendiente a la corrosión.
- Agudeza del corte durable
- Corte suave y regular
- Parti taglienti in carburo di tungsteno saldate e di conseguenza nessuna tendenza alla corrosione
- Taglio eccellente di lunga durata
- Funzionamento armonico e dolce



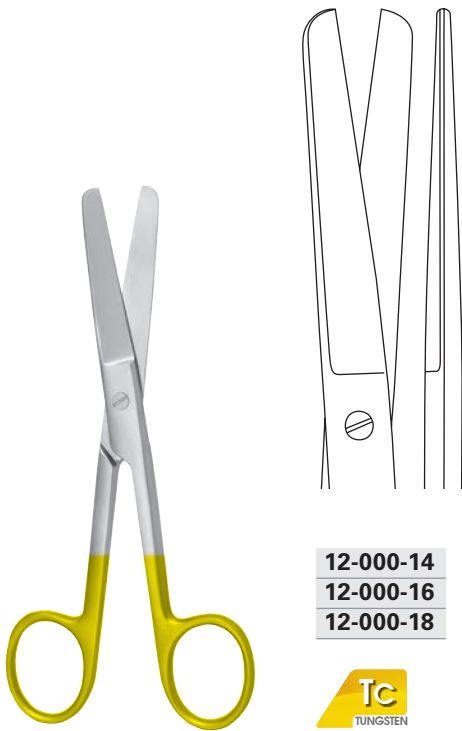

12-000-14
12-000-16
12-000-18



STANDARD Fig. 1

12-000-14	14,0 cm, 5 1/2 "
12-000-16	16,0 cm, 6 1/4 "
12-000-18	18,0 cm, 7 "

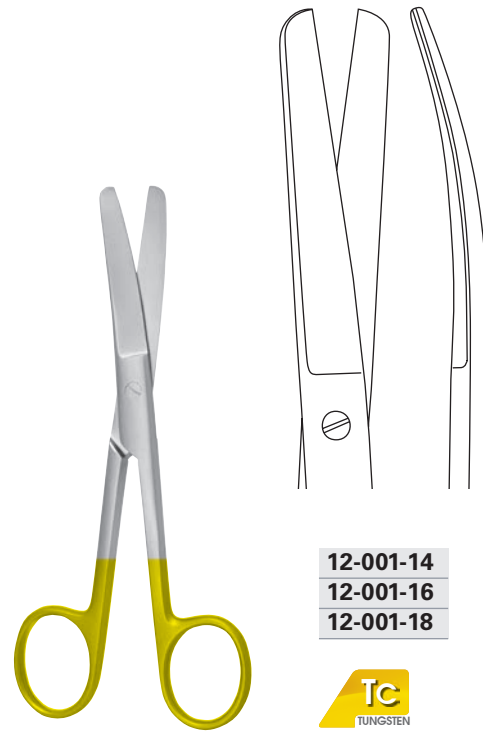

12-001-14
12-001-16
12-001-18

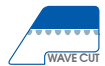

STANDARD Fig. 1

12-001-14	14,0 cm, 5 1/2 "
12-001-16	16,0 cm, 6 1/4 "
12-001-18	18,0 cm, 7 "

STANDARD Fig. 1

12-001-14 W	14,0 cm, 5 1/2 "
--------------------	------------------

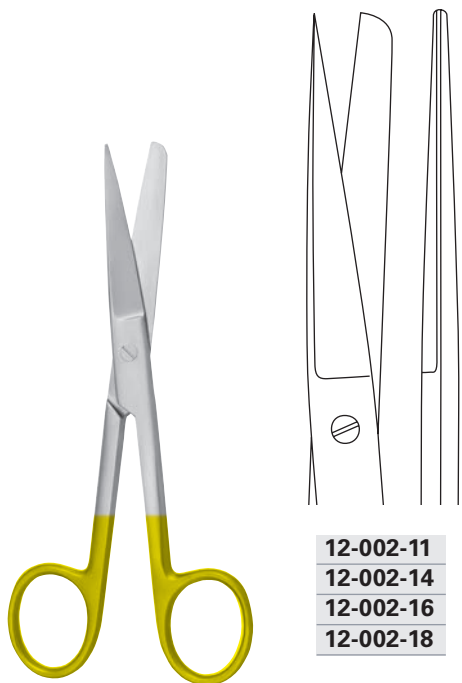

12-002-11
12-002-14
12-002-16
12-002-18



STANDARD Fig. 2

12-002-11	11,0 cm, 4 3/8 "
12-002-14	14,0 cm, 5 1/2 "
12-002-16	16,0 cm, 6 1/4 "
12-002-18	18,0 cm, 7 "

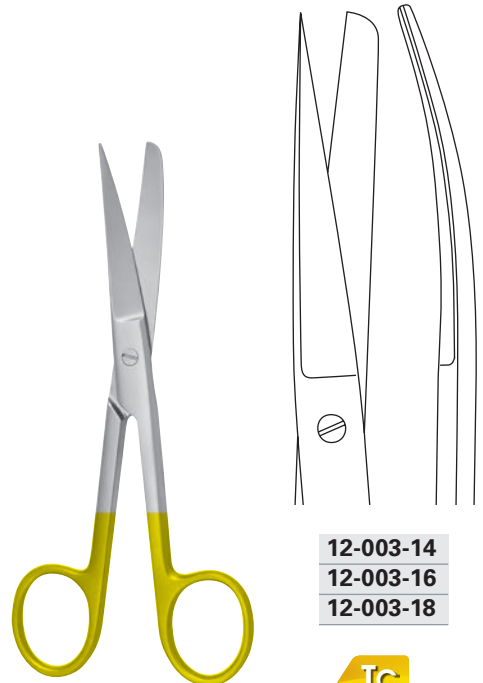

12-003-14
12-003-16
12-003-18



STANDARD Fig. 2

12-003-14	14,0 cm, 5 1/2 "
12-003-16	16,0 cm, 6 1/4 "
12-003-18	18,0 cm, 7 "

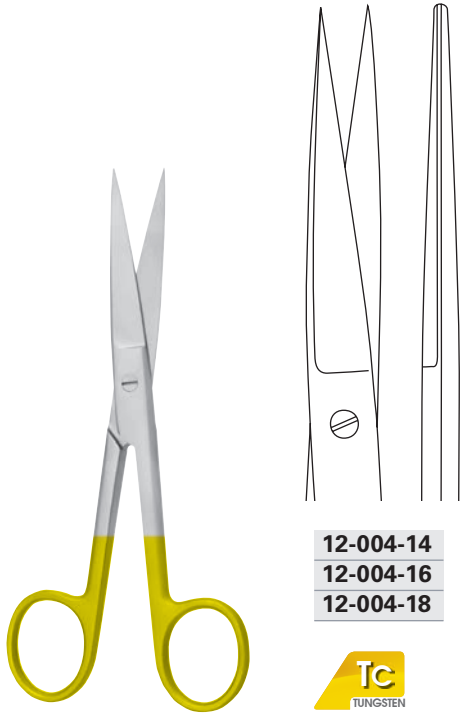

12-004-14
12-004-16
12-004-18



STANDARD Fig. 3

12-004-14	14,0 cm, 5 1/2"
12-004-16	16,0 cm, 6 1/4"
12-004-18	18,0 cm, 7"

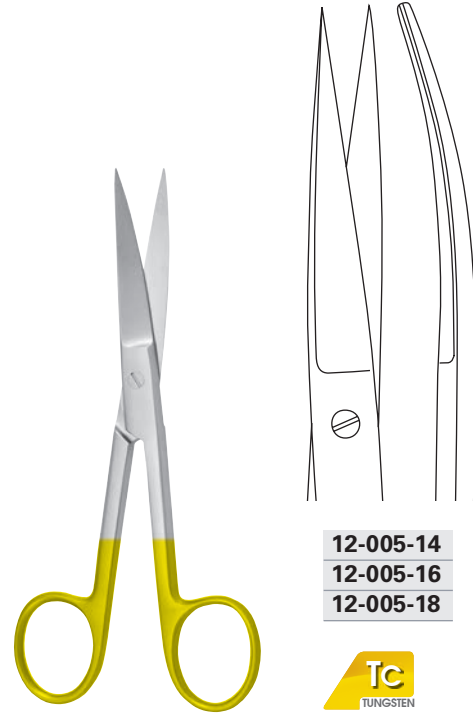

12-005-14
12-005-16
12-005-18



STANDARD Fig. 3

12-005-14	14,0 cm, 5 1/2"
12-005-16	16,0 cm, 6 1/4"
12-005-18	18,0 cm, 7"



12-107-15



MIXTER

12-107-15	15,0 cm, 6"
-----------	-------------



12-141-20



WALDMANN

12-141-20	20,0 cm, 8"
-----------	-------------

Damm Schere (Episiotomie)
Perineum scissors (Episiotomy)
Tijeras para perineo (episiotomía)
Forbici per perineo (episiotomia)

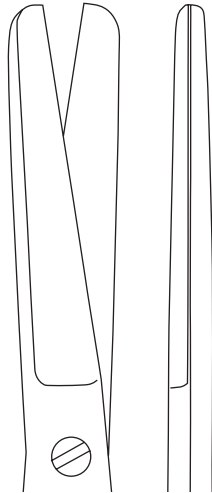

12-120-20
 12-120-23



12-121-20
 12-121-23



SIMS

12-120-20 - 12-121-20 20,0 cm, 8"

12-120-23 - 12-121-23 23,0 cm, 9"

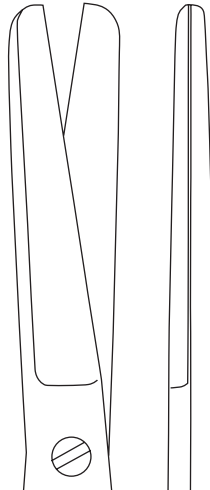

12-120-20 W



12-121-20 W
 12-121-23 W



SIMS

12-120-20 W - 12-121-20 W 20,0 cm, 8"

12-121-23 W 23,0 cm, 9"

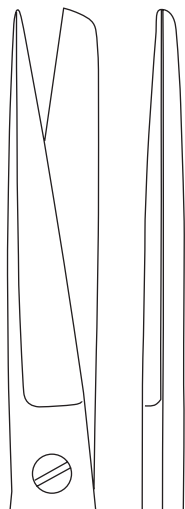

12-122-20
12-122-23



12-123-20
12-123-23



SIMS

12-122-20 - 12-123-20 20,0 cm, 8 "

12-122-23 - 12-123-23 23,0 cm, 9 "



12-124-20
12-124-23



12-125-20
12-125-23



SIMS

12-124-20 - 12-125-20 20,0 cm, 8 "

12-124-23 - 12-125-23 23,0 cm, 9 "

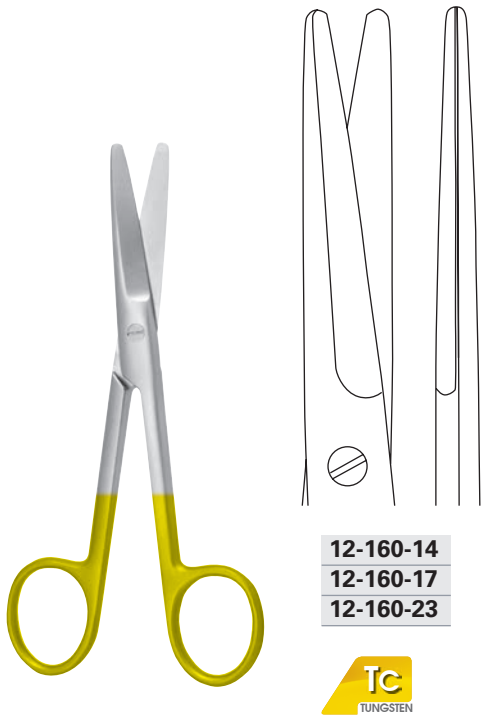

12-160-14
12-160-17
12-160-23



MAYO

12-160-14	14,0 cm, 5 1/2 "
12-160-17	17,0 cm, 6 3/4 "
12-160-23	23,0 cm, 9 "

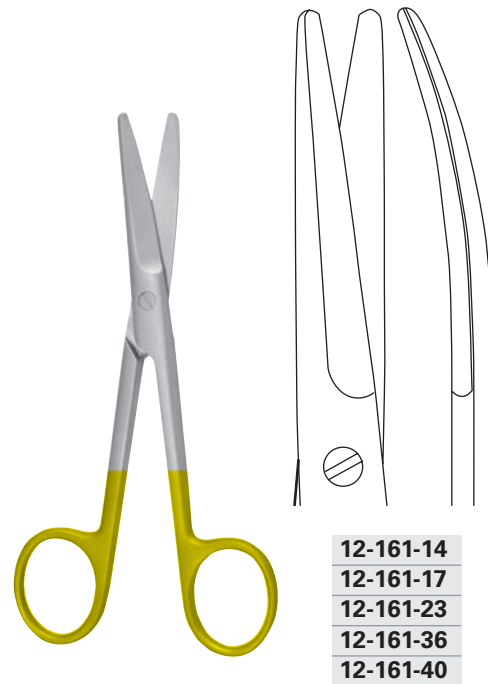

12-161-14
12-161-17
12-161-23
12-161-36
12-161-40



MAYO

12-161-14	14,0 cm, 5 1/2 "
12-161-17	17,0 cm, 6 3/4 "
12-161-23	23,0 cm, 9 "
12-161-36	36,0 cm, 14 1/4 "
12-161-40	40,0 cm, 16 "

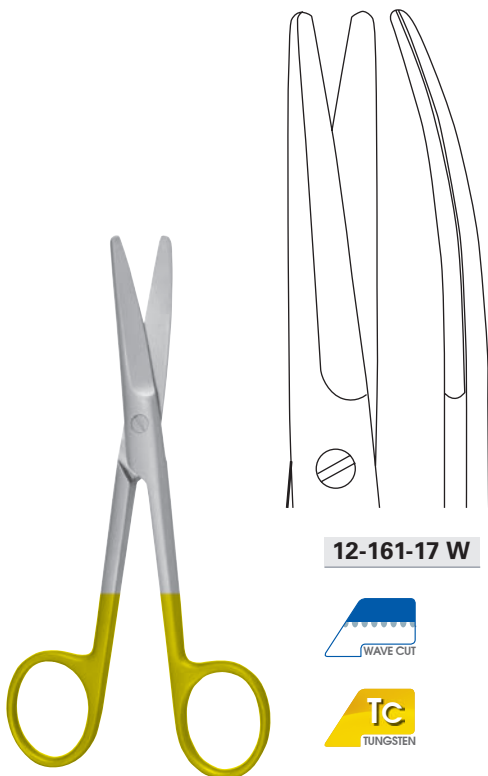

12-161-17 W



MAYO

12-161-17 W	17,0 cm, 6 3/4 "
-------------	------------------



12-166-22



MAYO-HARRINGTON

12-166-22	22,0 cm, 8 3/4 "
-----------	------------------

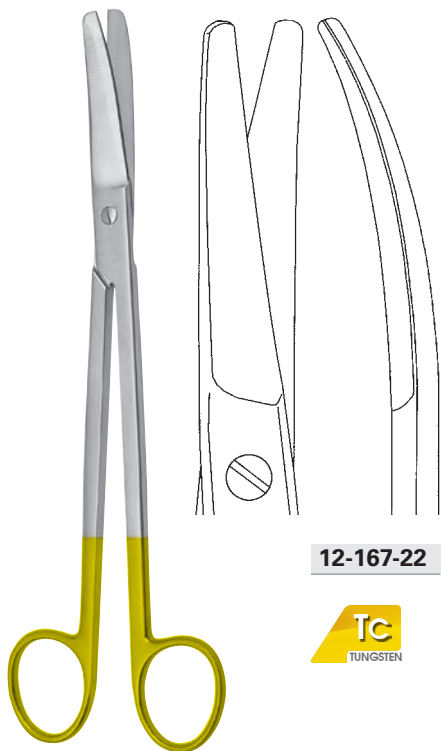

12-167-22

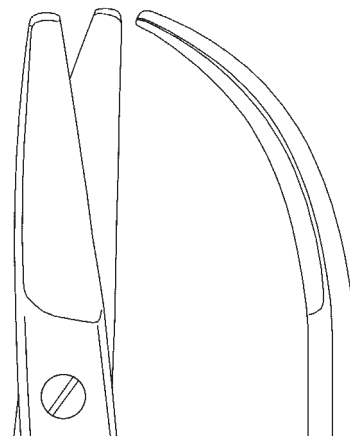

12-169-23



12-167-23



12-167-22 22,0 cm, 8 3/4"
12-169-23 23,0 cm, 9"

WERTHEIM

12-167-23 23,0 cm, 9"

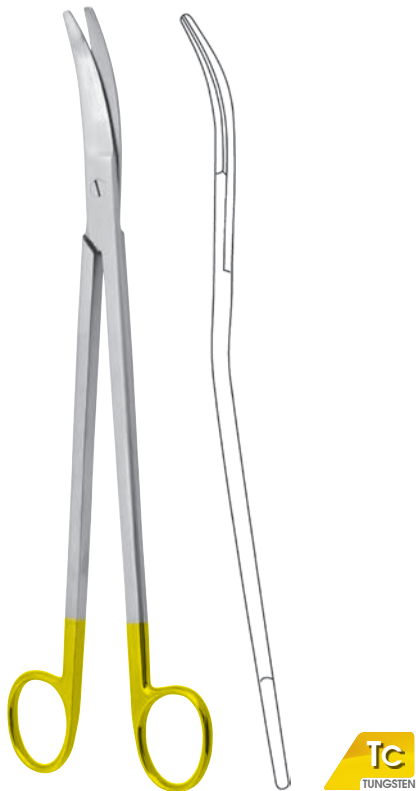

12-173-25 25,0 cm, 9 3/4"

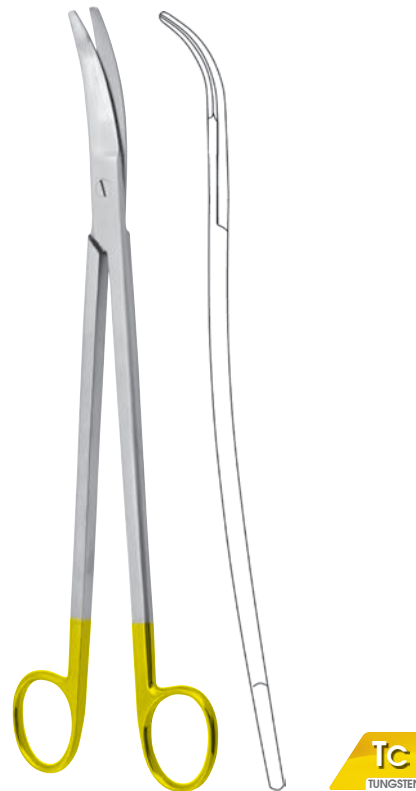

12-175-25 25,0 cm, 9 3/4"

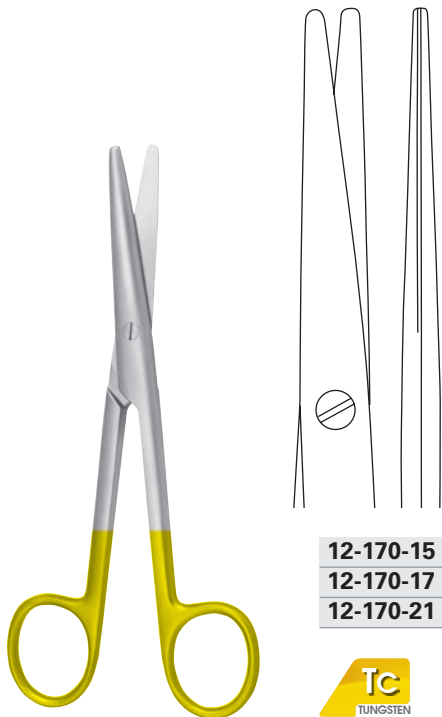

12-170-15
 12-170-17
 12-170-21



MAYO-STILLE

12-170-15	15,0 cm, 6 "
12-170-17	17,0 cm, 6 ¾ "
12-170-21	21,0 cm, 8 ¼ "

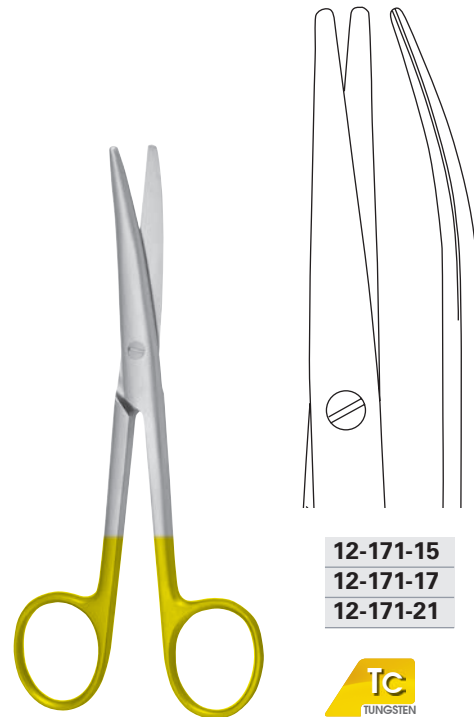

12-171-15
 12-171-17
 12-171-21



MAYO-STILLE

12-171-15	15,0 cm, 6 "
12-171-17	17,0 cm, 6 ¾ "
12-171-21	21,0 cm, 8 ¼ "



METZENBAUM

12-200-11	11,0 cm, 4 ⅜ "
12-200-14	14,0 cm, 5 ½ "
12-200-18	18,0 cm, 7 "
12-200-20	20,0 cm, 8 "
12-200-23	23,0 cm, 9 "
12-200-25	25,0 cm, 9 ¾ "
12-200-28	28,0 cm, 11 "
12-200-30	30,0 cm, 12 "



METZENBAUM

12-201-11	11,0 cm, 4 ⅜ "
12-201-14	14,0 cm, 5 ½ "
12-201-18	18,0 cm, 7 "
12-201-20	20,0 cm, 8 "
12-201-23	23,0 cm, 9 "
12-201-25	25,0 cm, 9 ¾ "
12-201-28	28,0 cm, 11 "
12-201-30	30,0 cm, 12 "
12-201-36	36,0 cm, 14 ¼ "
12-201-40	40,0 cm, 16 "

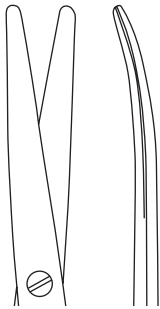
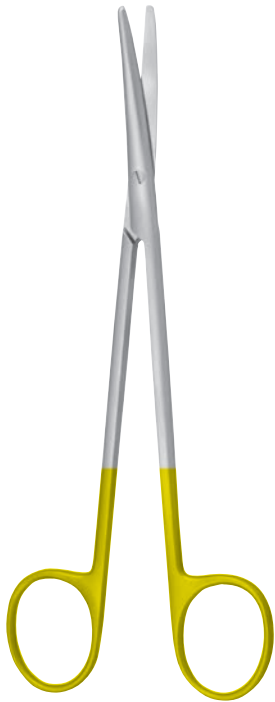

METZENBAUM

12-201-11 W	11,0 cm, 4 3/8 "
12-201-14 W	14,0 cm, 5 1/2 "
12-201-18 W	18,0 cm, 7 "
12-201-20 W	20,0 cm, 8 "
12-201-23 W	23,0 cm, 9 "

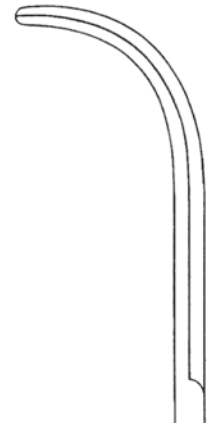
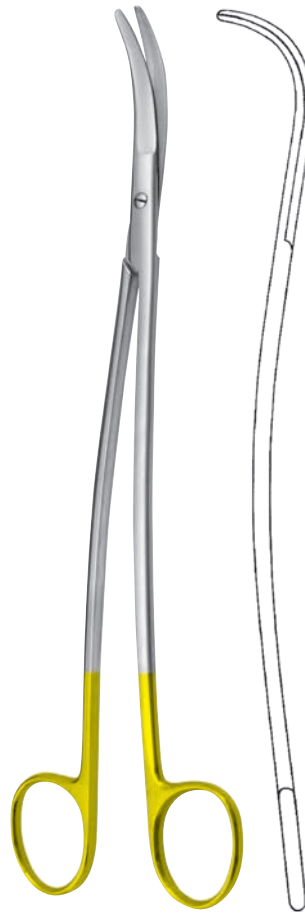

METZENBAUM-S

12-209-20	20,0 cm, 8 "
12-209-23	23,0 cm, 9 "
12-209-25	25,0 cm, 9 3/4 "
12-209-28	28,0 cm, 11 "

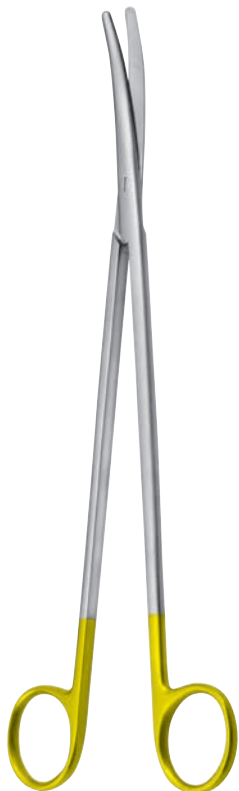

12-207-23



METZENBAUM

12-207-23 23,0 cm, 9 "

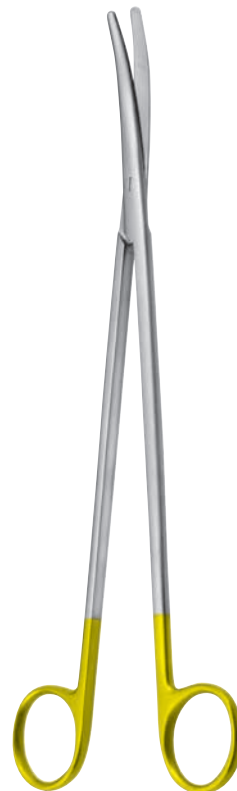

12-207-23 W



METZENBAUM

12-207-23 W 23,0 cm, 9 "

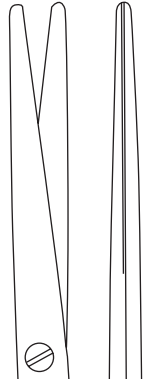
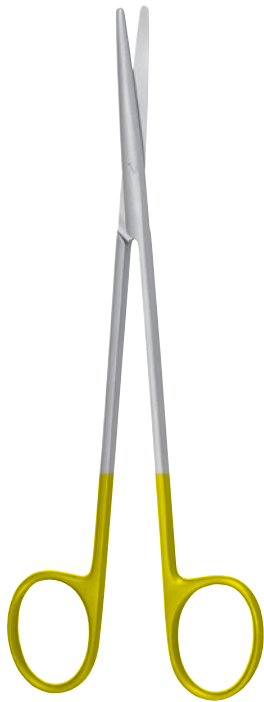

METZENBAUM-FINO

12-210-14	14,0 cm, 5 1/2 "
12-210-18	18,0 cm, 7 "
12-210-20	20,0 cm, 8 "
12-210-23	23,0 cm, 9 "
12-210-25	25,0 cm, 9 3/4 "
12-210-28	28,0 cm, 11 "

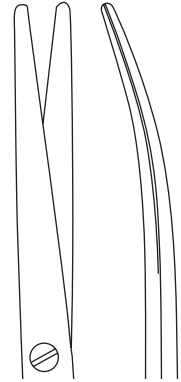

METZENBAUM-FINO

12-211-14	14,0 cm, 5 1/2 "
12-211-18	18,0 cm, 7 "
12-211-20	20,0 cm, 8 "
12-211-23	23,0 cm, 9 "
12-211-25	25,0 cm, 9 3/4 "
12-211-28	28,0 cm, 11 "

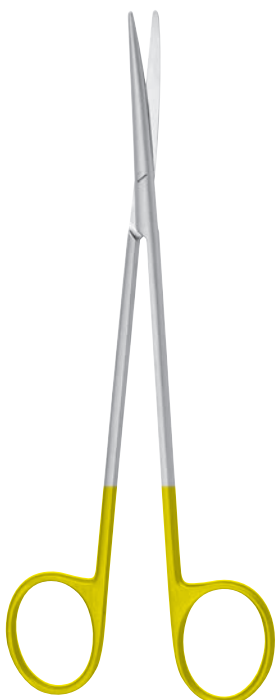

METZENBAUM-FINO

12-211-14 W	14,0 cm, 5 1/2 "
12-211-18 W	18,0 cm, 7 "
12-211-20 W	20,0 cm, 8 "
12-211-23 W	23,0 cm, 9 "
12-211-25 W	25,0 cm, 9 3/4 "
12-211-28 W	28,0 cm, 11 "

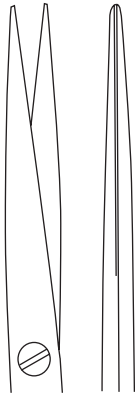

Tc
TUNGSTEN

METZENBAUM-FINO

12-214-14	14,0 cm, 5 1/2 "
12-214-18	18,0 cm, 7 "
12-214-20	20,0 cm, 8 "
12-214-23	23,0 cm, 9 "



Tc
TUNGSTEN

METZENBAUM-FINO

12-215-11	11,0 cm, 4 3/8 "
12-215-14	14,0 cm, 5 1/2 "
12-215-18	18,0 cm, 7 "
12-215-20	20,0 cm, 8 "
12-215-23	23,0 cm, 9 "

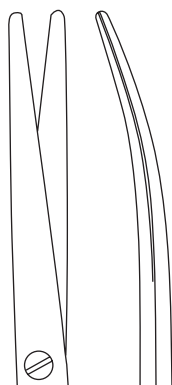
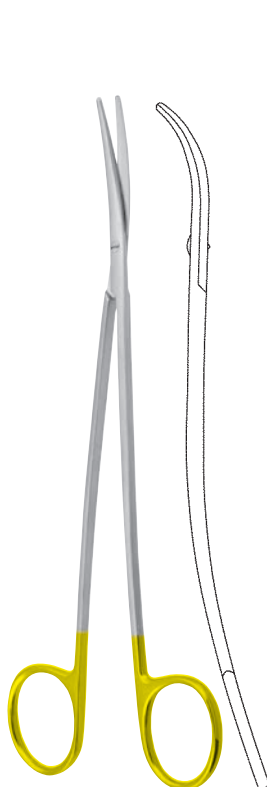

Tc
TUNGSTEN

METZENBAUM-FINO-S

12-221-18	18,0 cm, 7 "
12-221-20	20,0 cm, 8 "
12-221-23	23,0 cm, 9 "

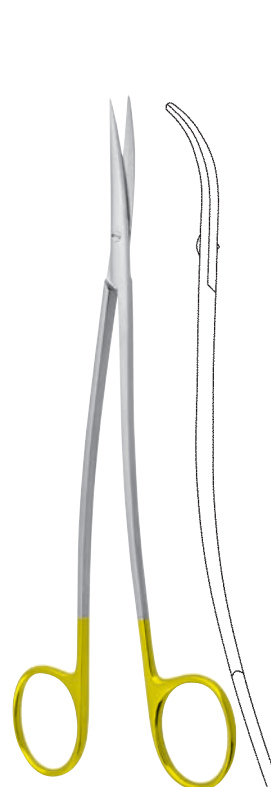

Tc
TUNGSTEN

METZENBAUM-FINO-S

12-225-18	18,0 cm, 7 "
12-225-20	20,0 cm, 8 "
12-225-23	23,0 cm, 9 "



12-230-16
 12-230-21

12-231-16
 12-231-21

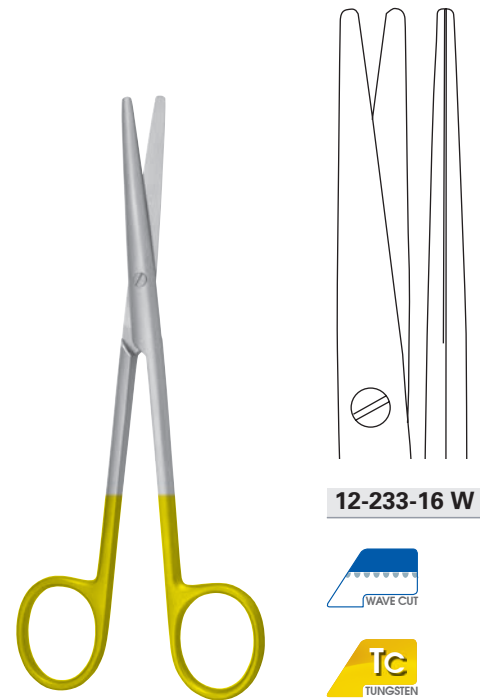

12-233-16 W

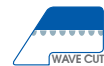

MAYO-LEXER

12-230-16 - 12-231-16 16,0 cm, 6 ¼"
 12-230-21 - 12-231-21 21,0 cm, 8 ¼"

LEXER

12-233-16 W 16,0 cm, 6 ¼"



12-232-16

12-233-16



12-241-20
 12-241-23
 12-241-28



LEXER

12-232-16 - 12-233-16 16,0 cm, 6 ¼"

THOREK

12-241-20 20,0 cm, 8"
 12-241-23 23,0 cm, 9"
 12-241-28 28,0 cm, 11"



12-243-14



JOSEPH

12-243-14 14,5 cm, 5 3/4"



12-245-12
12-245-15



KILNER

12-245-12 12,0 cm, 4 3/4"
12-245-15 15,0 cm, 5"

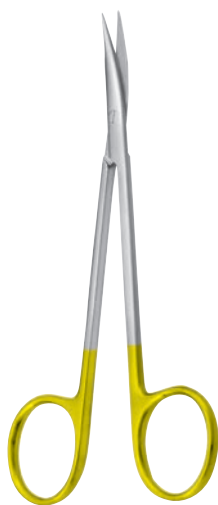

12-247-13
12-247-15



JAMESON

12-247-13 13,0 cm, 5 1/8"
12-247-15 15,0 cm, 5"

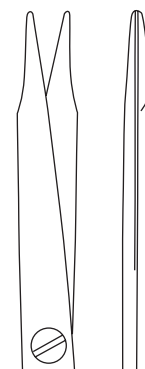

12-248-15



REYNOLDS

12-248-15 15,0 cm, 5"



12-249-15
 12-249-18



REYNOLDS

12-249-15 15,0 cm, 5 "
 12-249-18 18,0 cm, 7 "

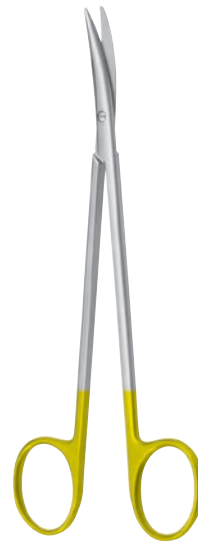

12-253-14



METZENBAUM-LAHEY

12-253-14 14,0 cm, 5 1/2 "

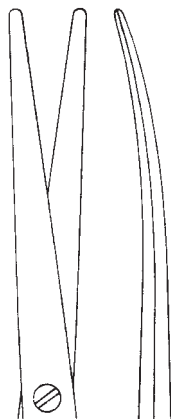
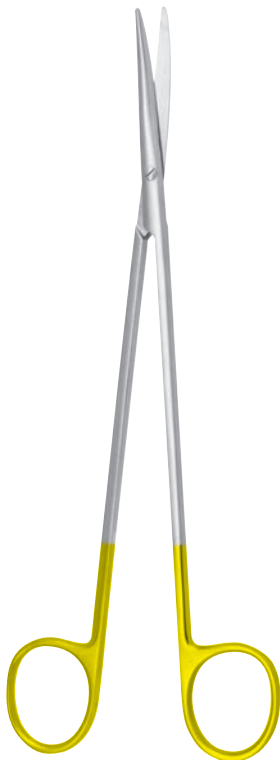

12-253-20
 12-253-23



METZENBAUM-LAHEY

12-253-20 20,0 cm, 8 "
 12-253-23 23,0 cm, 9 "



12-253-17



TOENNIS-ADSON

12-253-17 17,5 cm, 7 "



TOENNIS-ADSON

12-253-17 W 17,5 cm, 7 "

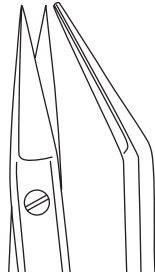
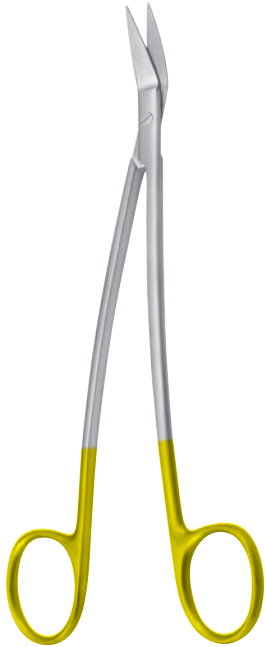

12-305-17



Tonsillenschere
Tonsil scissors
Tijera para amígdalas
Forbici per tonsille

DEAN

12-305-17 17,0 cm, 6 3/4"



12-319-13



Nasenschere
Nasal scissors
Tijera nasales
Forbici nasali

FOMON

12-319-13 13,0 cm, 5 1/8"



12-329-13



Nasenschere
Nasal scissors
Tijera nasales
Forbici nasali

FOMON

12-329-13 13,0 cm, 5 1/8"



12-331-16



Nasenschere
Nasal scissors
Tijera nasales
Forbici nasali

COTTLE

12-331-16 16,0 cm, 6 1/4"

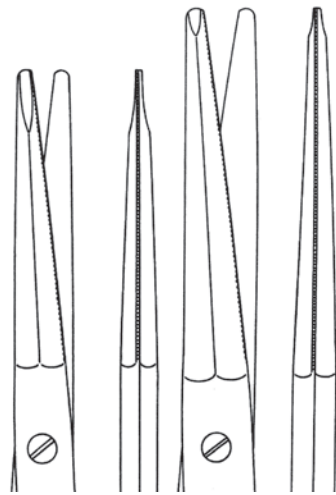

12-360-20

12-360-23



GORNEY

12-360-20	20,0 cm, 8 "
12-360-23	23,0 cm, 9 "



12-363-14



GREGORY

12-363-14	14,0 cm, 5 1/2 "
-----------	------------------



12-365-15
 12-365-18



KAYE

12-365-15	14,5 cm, 5 3/4 "
12-365-18	18,0 cm, 7 "



12-367-18



STELLA

12-367-18	18,0 cm, 7 "
-----------	--------------

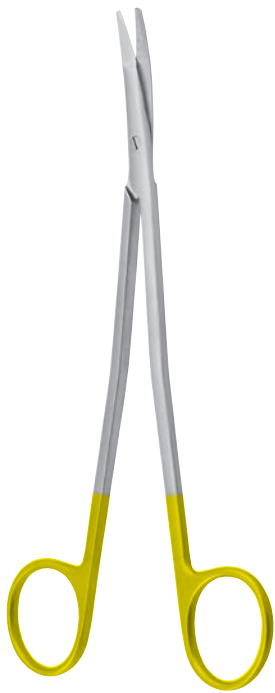

12-369-18



GORNEY-FREEMAN

12-369-18 18,0 cm, 7 "

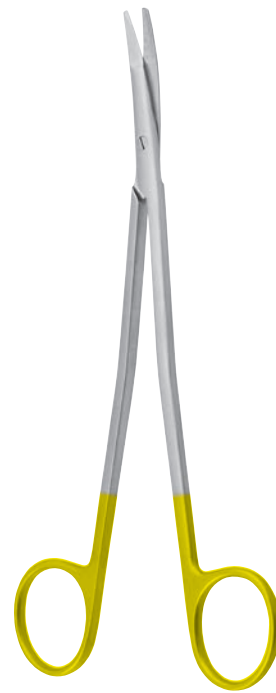

12-370-23



GORNEY-FREEMAN

12-370-23 23,0 cm, 9 "

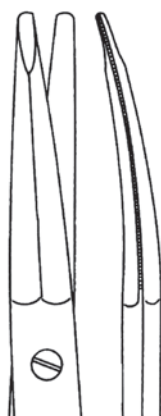

12-371-18



FREEMAN-KAYE

12-371-18 18,0 cm, 7 "

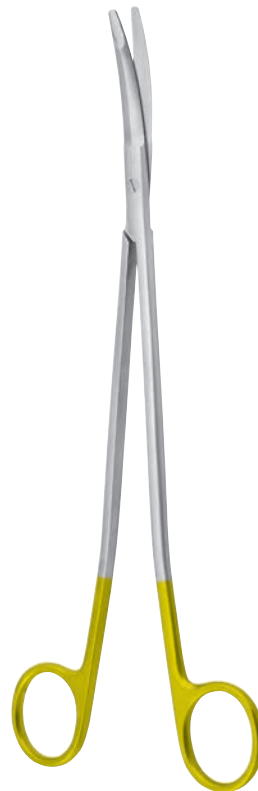

12-371-23



FREEMAN-GORNEY

12-371-23 23,0 cm, 9 "

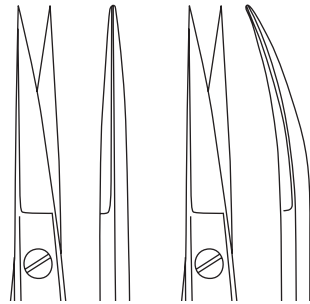
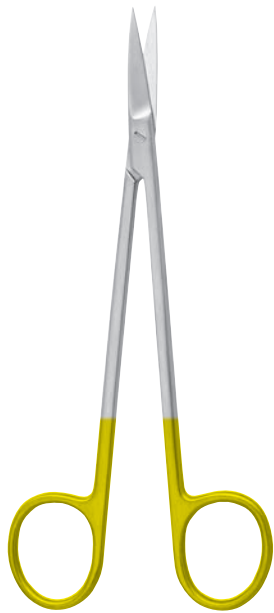

12-400-16

12-401-16

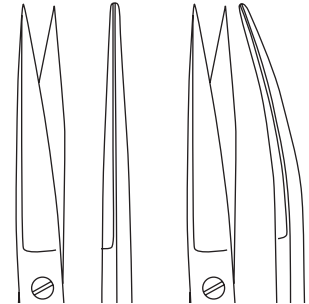

12-404-14

12-405-14



KELLY

12-400-16 - 12-401-16 16,0 cm, 6 ¼ "

JOSEPH

12-404-14 - 12-405-14 14,0 cm, 5 ½ "

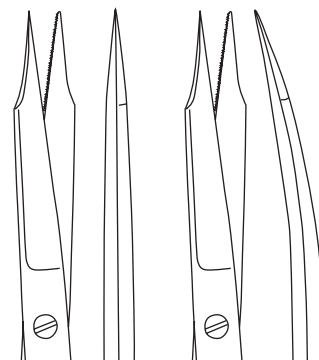

12-416-13

12-417-13

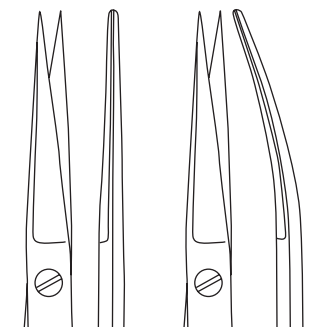

12-424-12

12-425-12



GOLDMANN-FOX

12-416-13 - 12-417-13 13,0 cm, 5 ⅛ "

Zahnfleissscheren
 Gum scissors
 Tijeras para encías
 Forbici per gengiva

WAGNER

12-424-12 - 12-425-12 12,0 cm, 4 ¾ "

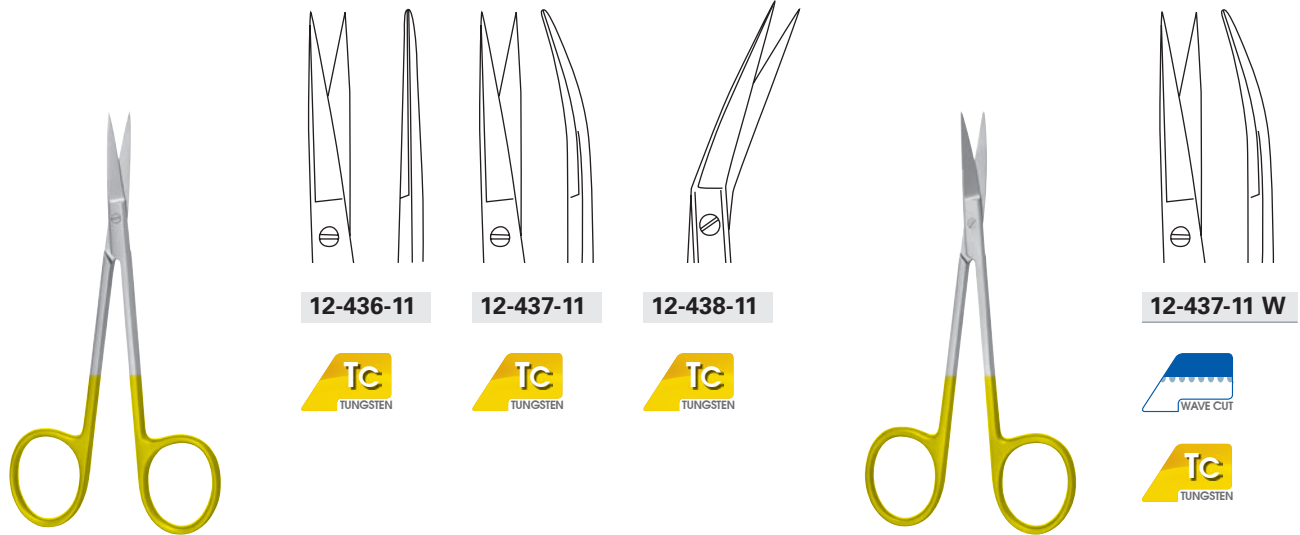

IRIS

12-436-11 - 12-438-11 11,5 cm, 4 ½ "

12-437-11 W 17,0 cm, 6 ¾ "



LOCKLIN

12-519-16 16,0 cm, 6 ¼ "

Zahnfleischschere
Gum scissors
Tijera para encías
Forbici per gengiva

LOCKLIN-S

12-521-16 16,0 cm, 6 ¼ "

Zahnfleischschere
Gum scissors
Tijera para encías
Forbici per gengiva

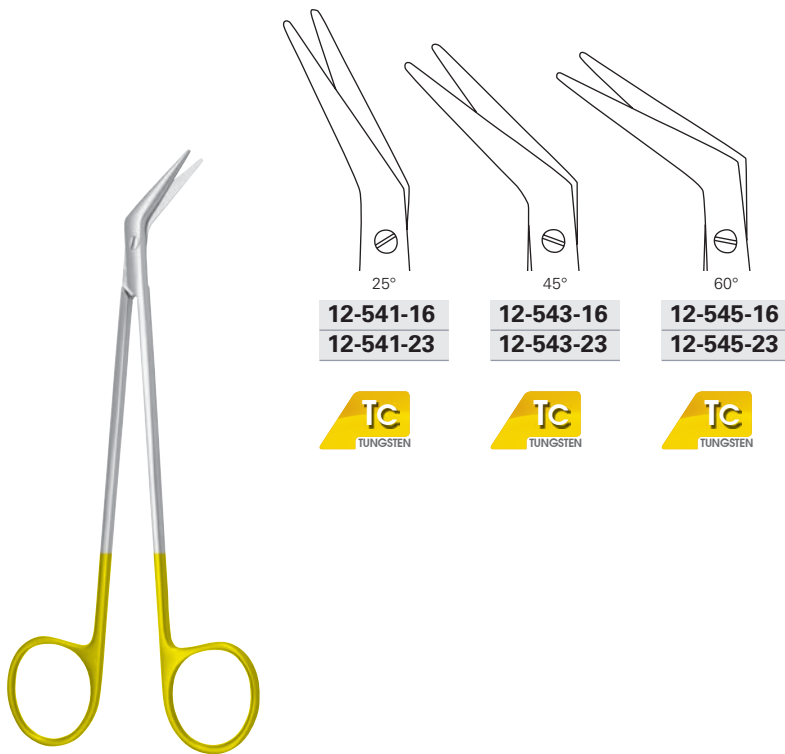

12-541-16
 12-541-23

12-543-16
 12-543-23

12-545-16
 12-545-23



DE BAKEY

12-541-16 - 12-545-16 16,0 cm, 6 ¼ "

12-541-23 - 12-545-23 23,0 cm, 9 "



12-551-19

12-553-19

12-555-19



POTTS-SMITH

12-551-19 - 12-555-19 19,0 cm, 7 ½ "

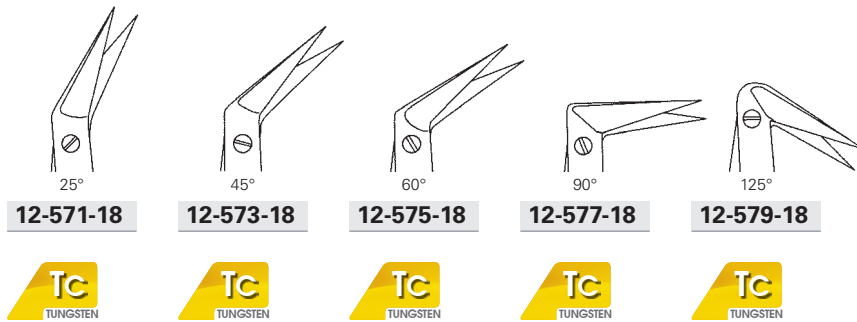
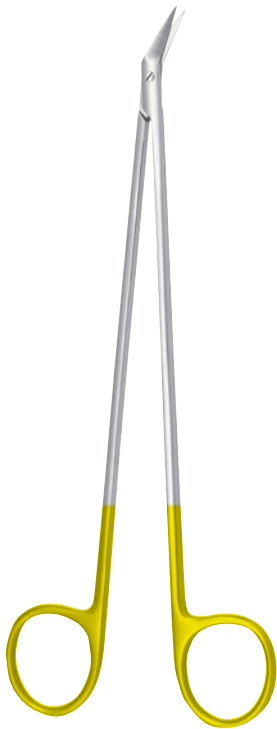

Gefäßscheren
Vascular scissors
Tijeras vasculares
Forbici vascolari

HEGEMANN-DIETRICH

12-571-18 - 12-579-18 18,0 cm, 7 "



UNIVERSAL

12-721-12 12,0 cm, 4 ¾ "

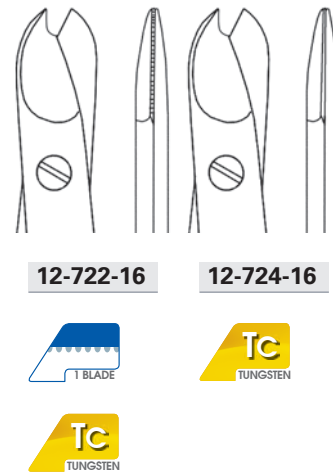
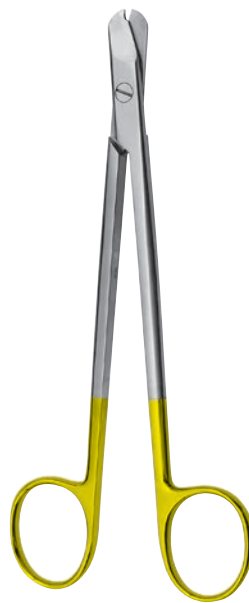

SMITH

12-722-16 - 12-724-16 16,0 cm, 6 ¼ "

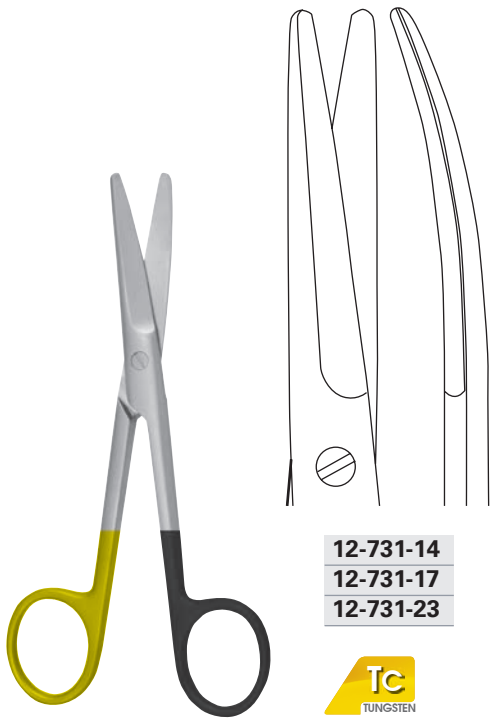

12-731-14
 12-731-17
 12-731-23



MAYO

12-731-14	14,0 cm, 5 1/2 "
12-731-17	17,0 cm, 6 3/4 "
12-731-23	23,0 cm, 9 "

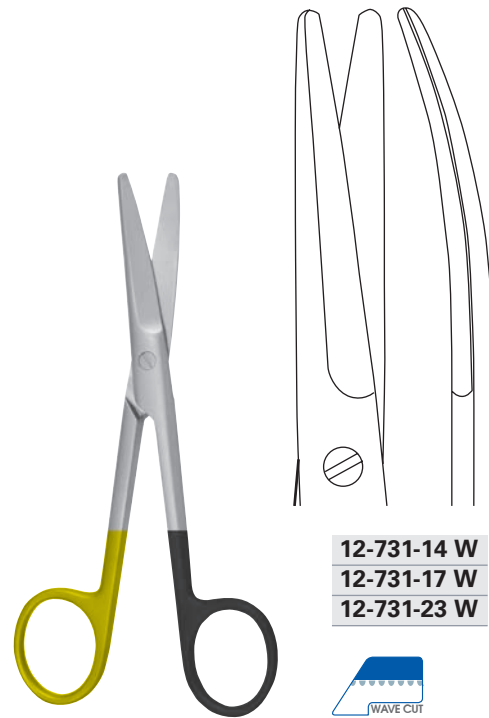

12-731-14 W
 12-731-17 W
 12-731-23 W



MAYO

12-731-14 W	14,0 cm, 5 1/2 "
12-731-17 W	17,0 cm, 6 3/4 "
12-731-23 W	23,0 cm, 9 "

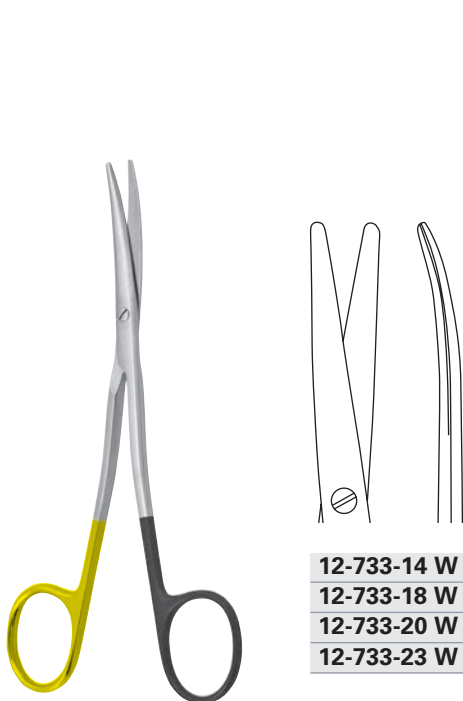

12-733-14 W
 12-733-18 W
 12-733-20 W
 12-733-23 W



METZENBAUM

12-733-14 W	14,0 cm, 5 1/2 "
12-733-18 W	18,0 cm, 7 "
12-733-20 W	20,0 cm, 8 "
12-733-23 W	23,0 cm, 9 "



12-733-26 W



METZENBAUM

12-733-26 W	26,0 cm, 10 1/4 "
--------------------	-------------------





12



SUPERCUT TITAN-NITRIT
Scheren

SUPERCUT TITANIUM-NITRITE
scissors

Tijeras SUPERCUT NITRITO
de TITANIO

Forbici SUPERCUT NITRITO
di TITANIO

Kennzeichnung: schwarzes Finish, goldene Schraube
Characteristic: black finish, golden screw
Característica: superficie negro, tornillo dorado
Caratteristica: finitura nero, vite dorata



Schneidegeometrie
Cutting geometry
Geometria del corte
Geometria di taglio

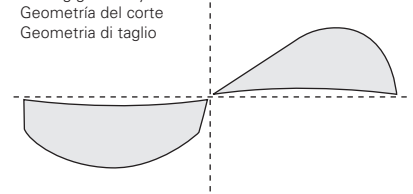

Bei SUPERCUT TITAN-NITRIT Scheren hat ein Blatt die Schneidegeometrie eines Messers, was einen mühelosen, messerartigen Schnitt ermöglicht.

Beschichtungen aus TITAN-NITRIT:

- Durch die elektro-physikalische Glättung wird die Gleitfähigkeit der Instrumente stark verbessert, was einen geringeren Abrieb und damit weniger Verschleiß zur Folge hat.
- Die außergewöhnliche Glätte führt zu einem leichten Gleiten der Scherenblätter auch bei höchster Beanspruchung.
- Dank der glatten Oberfläche wird die Reinigung der Scheren wesentlich erleichtert.
- Durch die Beschichtung erhöht sich die Oberflächenhärte um das 3-5 fache. Dies vervielfacht die Standzeit der Schneidekanten und macht die Instrumente äußerst kratzfest und schlagzäh.
- Die Beschichtung ist in hohem Maße inert, d.h. die molekulare Bindung ist chemisch sehr widerstandsfähig. Dadurch werden unerwünschte Reaktionen beim Eintauchen in Lösungen oder bei der Sterilisation vermieden.
- Auch beim intensiven Einsatz in sauren oder basischen Lösungen bleibt die hohe Glätte der Oberfläche erhalten.
- Die inerte Beschichtung ist auch bei hohen Temperaturen stabil.

Eigenschaften von TIN - Beschichtungen:

- 3-5 fache Härte gegenüber gehärtetem Stahl
- glatte, dichte, keramische Materialstruktur
- edle Oberflächenoptik, weniger Reflexion
- antikorrosive, leicht zu reinigende Oberfläche
- wesentlich beständiger gegen Lösungsmittel und aggressive Flüssigkeiten als unbeschichteter Stahl
- kratzbeständig
- temperaturbeständig
- hohe Haftfestigkeit
- geringe Reibung



Scissors with SUPERCUT TITANIUM-NITRITE have one razor blade which allows an easy and clean cut through tissue.

TITANIUM NITRITE coatings:

- The glide quality of the instruments is considerably improved by electrophysical smoothing, resulting in less abrasion and reduced wear.
- The exceptional smoothness means that the scissor blades slide easily, even under maximum stress.
- The smooth surface makes the scissors much easier to clean.
- The coating makes the surface three to five times harder. This multiplies the lifetime of the cutting edges and makes the instruments extremely resistant to scratches and impacts.
- The coating is largely inert, which means that the molecular binding is very chemically resistant. This prevents undesirable reactions when the instruments are immersed in solutions or sterilised.
- Even under intensive use of acid or alkaline solutions, the high level of surface smoothness is retained.
- The inert coating is also stable at high temperatures.

Characteristics of TIN - coatings:

- 3-5 times harder than hardened steel
- smooth, impervious, ceramic material structure
- high-grade surface finish, reduced reflection
- anti-corrosive, easy to clean surface
- far more resistant to solvents and aggressive fluids than uncoated steel
- scratch-resistant
- temperature-resistant
- high level of adherence
- low friction



Las tijeras SUPERCUT con revestimiento de NITRITO DE TITANIO tienen una de las hojas con la geometría de corte de un bisturí, lo que permite realizar la incisión sin esfuerzo, como si se tratara realmente de un bisturí.

Revestimiento de NITRITO DE TITANIO:

- El alisado electrofísico mejora considerablemente la capacidad de deslizamiento del instrumental, por lo que se produce menor abrasión y, en consecuencia, un desgaste más reducido.
- Gracias a su extraordinaria suavidad, las hojas de las tijeras se deslizan fácilmente, incluso en las condiciones más difíciles.
- Además, esta superficie lisa facilita también las operaciones de limpieza.
- Por otro lado, el revestimiento aumenta de tres a cinco veces la dureza de la superficie, lo que también alarga la duración de los cantos de corte y protege enormemente los instrumentos frente al rayado o a los golpes.
- El revestimiento es prácticamente inerte, es decir, el enlace molecular es químicamente resistente, lo que excluye la posibilidad de que se produzcan reacciones no deseadas al introducir las tijeras en ciertas disoluciones o esterilizarlas.
- La suavidad y lisura de la superficie se mantiene incluso con un uso intensivo en disoluciones ácidas o básicas.
- El revestimiento inerte también es estable a altas temperaturas.

Propiedades de los revestimientos de nitrato de titanio:

- de tres a cinco más de dureza que el acero endurecido
- estructura del material cerámico compacta y lisa
- aspecto exterior impecable, con menos reflexión
- superficie anticorrosiva y fácil de limpiar
- mucho más resistente a disolventes y líquidos agresivos que el acero no revestido
- resistente al rayado
- resistente a los cambios térmicos
- alta fuerza adhesiva
- poca fricción



Le forbici SUPERCUT in NITRITO di TITANIO hanno una lama con la geometria di taglio di un coltello che consente di eseguire tagli agevoli, puliti e precisi come un coltello.

Rivestimento in NITRITO di TITANIO:

- La capacità allo scorrimento degli strumenti è notevolmente migliorata grazie alla levigatura elettro-fisica: ciò significa una ridotta abrasione e quindi una minore usura.
- L'eccellente levigatura consente un agevole scorrimento delle lame della forbice anche nelle sollecitazioni più estreme.
- La pulizia delle forbici è notevolmente facilitata grazie alla superficie liscia.
- Il rivestimento aumenta la durezza della superficie di 3-5 volte. Ciò moltiplica la durata utile degli spigoli taglienti e rende gli strumenti estremamente resistenti ai graffi e agli urti.
- Il rivestimento è altamente inerte, ciò significa che il legame molecolare è chimicamente molto resistente. Questo evita reazioni indesiderate durante l'immersione in soluzioni o nel corso dell'operazione di sterilizzazione.
- La grande levigatezza delle superfici non viene intaccata neanche con un uso intenso in soluzioni acide e basiche.
- Il rivestimento inerte è stabile anche ad alte temperature.

Proprietà di rivestimenti in TIN:

- durezza 3-5 volte superiore rispetto all'acciaio temprato
- struttura del materiale levigata, compatta e ceramizzata
- superficie di ottica pregiata, meno riflettente
- superficie anticorrosione, facile da pulire
- notevolmente più resistente dell'acciaio non rivestito nei confronti di solventi e liquidi aggressivi
- antigraffio
- termostabile
- elevata adesività
- basso attrito



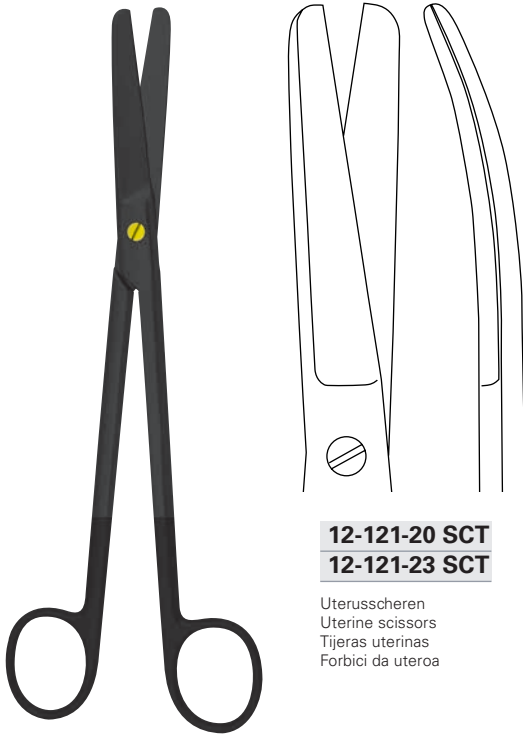

12-121-20 SCT
12-121-23 SCT

Uterusscheren
Uterine scissors
Tijeras uterinas
Forbici da uteroa

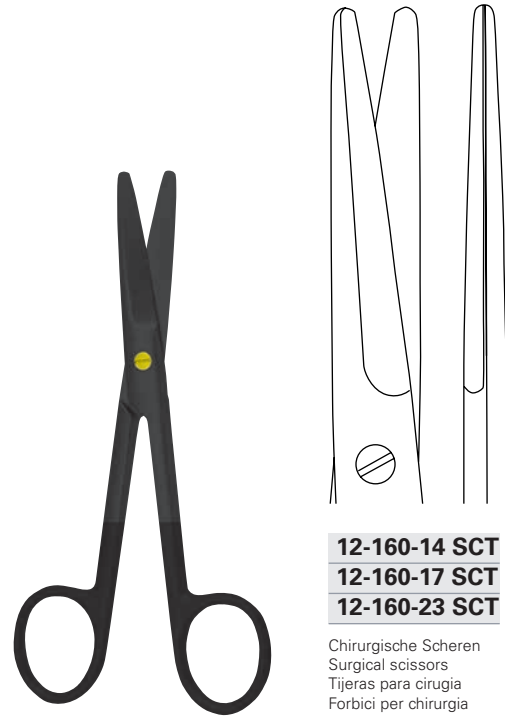

12-160-14 SCT
12-160-17 SCT
12-160-23 SCT

Chirurgische Scheren
Surgical scissors
Tijeras para cirugia
Forbici per chirurgia

SIMS

12-121-20 SCT 20,0 cm, 8"
12-121-23 SCT 23,0 cm, 9"



MAYO

12-160-14 SCT 14,0 cm, 5 1/2"
12-160-17 SCT 17,0 cm, 6 3/4"
12-160-23 SCT 23,0 cm, 9"

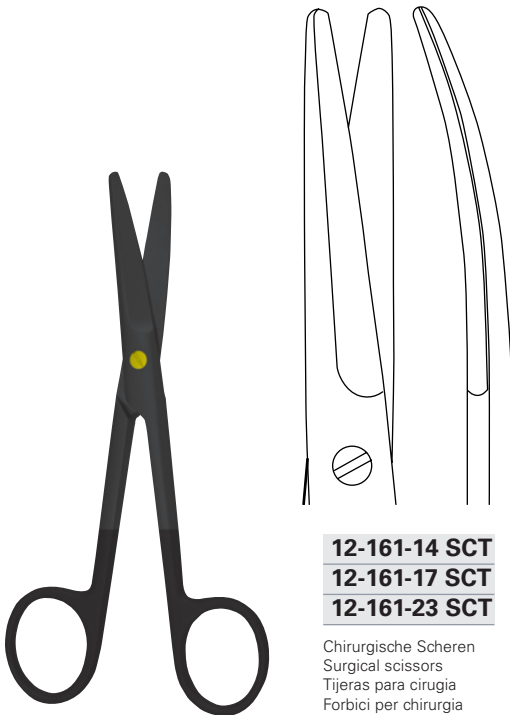

12-161-14 SCT
12-161-17 SCT
12-161-23 SCT

Chirurgische Scheren
Surgical scissors
Tijeras para cirugia
Forbici per chirurgia



12-167-22 SCT

Chirurgische Schere
Surgical scissors
Tijera para cirugia
Forbici per chirurgia

MAYO

12-161-14 SCT 14,0 cm, 5 1/2"
12-161-17 SCT 17,0 cm, 6 3/4"
12-161-23 SCT 23,0 cm, 9"



MAYO-HARRINGTON

12-167-22 SCT 22,0 cm, 8 3/4"



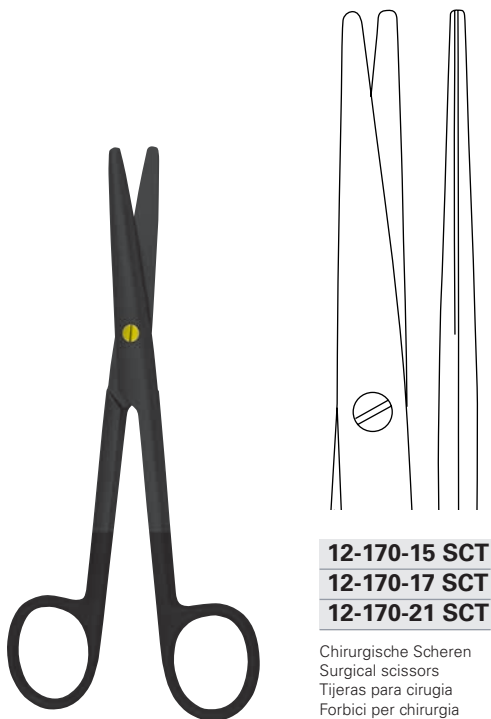

12-170-15 SCT
12-170-17 SCT
12-170-21 SCT

Chirurgische Scheren
 Surgical scissors
 Tijeras para cirugía
 Forbici per chirurgia

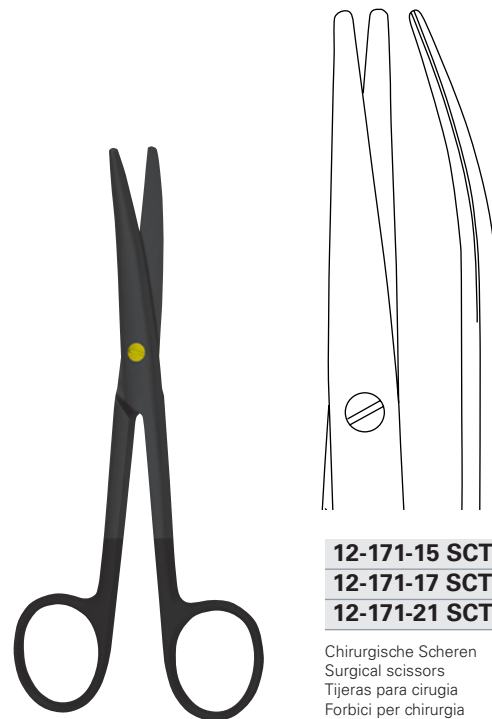

12-171-15 SCT
12-171-17 SCT
12-171-21 SCT

Chirurgische Scheren
 Surgical scissors
 Tijeras para cirugía
 Forbici per chirurgia

MAYO-STILLE

12-170-15 SCT	15,0 cm, 6 "
12-170-17 SCT	17,0 cm, 6 3/4 "
12-170-21 SCT	21,0 cm, 8 1/4 "



MAYO-STILLE

12-171-15 SCT	15,0 cm, 6 "
12-171-17 SCT	17,0 cm, 6 3/4 "
12-171-21 SCT	21,0 cm, 8 1/4 "



Präparierscheren
 Dissecting scissors
 Tijeras des disección
 Forbici per dissezione



METZENBAUM

12-200-11 SCT	11,0 cm, 4 3/8 "
12-200-14 SCT	14,0 cm, 5 1/2 "
12-200-18 SCT	18,0 cm, 7 "
12-200-20 SCT	20,0 cm, 8 "
12-200-23 SCT	23,0 cm, 9 "
12-200-25 SCT	25,0 cm, 9 3/4 "
12-200-28 SCT	28,0 cm, 11 "
12-200-30 SCT	30,0 cm, 12 "



Präparierscheren
 Dissecting scissors
 Tijeras des disección
 Forbici per dissezione



METZENBAUM

12-201-11 SCT	11,0 cm, 4 3/8 "
12-201-14 SCT	14,0 cm, 5 1/2 "
12-201-18 SCT	18,0 cm, 7 "
12-201-20 SCT	20,0 cm, 8 "
12-201-23 SCT	23,0 cm, 9 "
12-201-25 SCT	25,0 cm, 9 3/4 "
12-201-28 SCT	28,0 cm, 11 "
12-201-30 SCT	30,0 cm, 12 "





Präparierscheren
Dissecting scissors
Tijeras des disección
Forbici per dissezione

METZENBAUM-FINO

12-211-11 SCT	11,0 cm, 4 ³ / ₈ "
12-211-14 SCT	14,0 cm, 5 ¹ / ₂ "
12-211-18 SCT	18,0 cm, 7 "
12-211-20 SCT	20,0 cm, 8 "
12-211-23 SCT	23,0 cm, 9 "
12-211-25 SCT	25,0 cm, 9 ³ / ₄ "
12-211-28 SCT	28,0 cm, 11 "

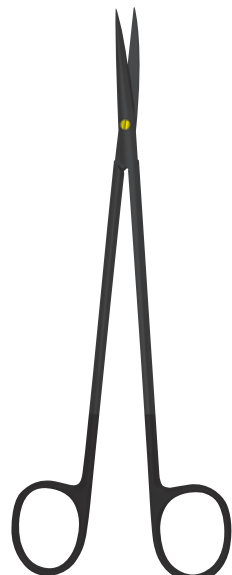
SCT
TITANITRIT

12-215-14 SCT

Präparierschere
Dissecting scissors
Tijera des disección
Forbici per dissezione

METZENBAUM-FINO

12-215-14 SCT 14,0 cm, 5 ¹/₂ "

SCT
TITANITRIT



12-221-14 SCT

Präparierschere
Dissecting scissors
Tijera des disección
Forbici per dissezione

METZENBAUM-FINO-S

12-221-14 SCT 14,0 cm, 5 ¹/₂ "

SCT
TITANITRIT





12-232-16 SCT **12-233-16 SCT**

Präparierscheren
Dissecting scissors
Tijeras des disección
Forbici per dissezione

LEXER

12-232-16 SCT - 12-233-16 SCT 16,0 cm, 6 ¹/₄ "

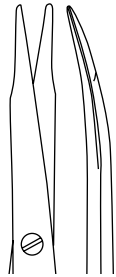
SCT
TITANITRIT



12-247-15 SCT

Präparierschere
 Dissecting scissors
 Tijera des disección
 Forbici per dissezione

JAMESON

12-247-15 SCT 15,0 cm, 6 "



12-249-15 SCT

Präparierschere
 Dissecting scissors
 Tijera des disección
 Forbici per dissezione

REYNOLDS

12-249-15 SCT 15,0 cm, 6 "

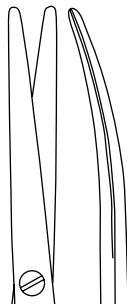

12-253-17 SCT

Präparierschere
 Dissecting scissors
 Tijera des disección
 Forbici per dissezione

TOENNIS-ADSON

12-253-17 SCT 17,5 cm, 7 "



12-329-13 SCT

Nasenschere
 Nasal scissors
 Tijera nasales
 Forbici nasali

FOMON

12-329-13 SCT 13,0 cm, 5 1/8 "





12-335-18 SCT

Nasenschere
Nasal scissors
Tijera nasales
Forbici nasali

HEYMANN

12-335-18 SCT 18,0 cm, 7 "



12-361-18 SCT



Face-lift Scheren
Face-lift scissors
Tijeras para Face-lift
Forbici per Face-lift

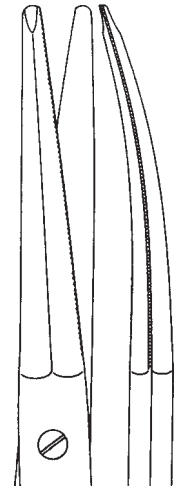

12-361-23 SCT



GREGORY

12-361-18 SCT 18,0 cm, 7 "

12-361-23 SCT 23,0 cm, 9 "



12-400-16 SCT



Feine chirurgische Scheren
Delicate surgical scissors
Tijeras finas para cirugía
Forbici fine per chirurgia



12-401-16 SCT



KELLY

12-400-16 SCT - 12-401-16 SCT 16,0 cm, 6 ¼ "



12-404-14 SCT



Feine chirurgische Scheren
Delicate surgical scissors
Tijeras finas para cirugía
Forbici fine per chirurgia



12-405-14 SCT



JOSEPH

12-404-14 SCT - 12-405-14 SCT 14,0 cm, 5 ½ "

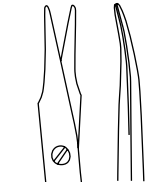

12-433-11 SCT

Feine chirurgische Scheren
 Delicate surgical scissors
 Tijeras finas para cirugía
 Forbici fine per chirurgia



12-436-11 SCT



12-437-11 SCT



Feine chirurgische Scheren
 Delicate surgical scissors
 Tijeras finas para cirugía
 Forbici fine per chirurgia

STEVENS

12-433-11 SCT 11,5 cm, 4 ½"



IRIS

12-436-11 SCT - 12-437-11 SCT 11,5 cm, 4 ½"

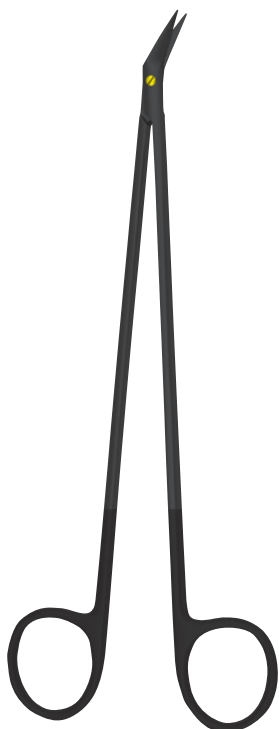

12-571-19 SCT

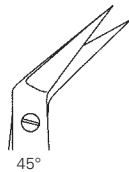

12-573-19 SCT

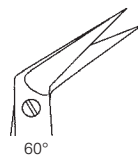

12-575-19 SCT

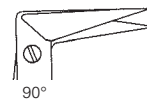

12-577-19 SCT

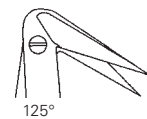

12-579-18 SCT



Gefäßscheren
 Vascular scissors
 Tijeras vasculares
 Forbici vascolari

HEGEMANN-DIETRICH

12-571-19 SCT - 12-579-19 SCT 19,0 cm, 7 ½"

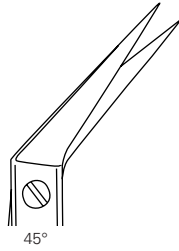

45°

12-573-21 SCT

Gefäßschere
Vascular scissors
Tijera vasculares
Forbici vascolari

POTTS-DE MARTEL

12-573-21 SCT 21,0 cm, 8 ¼ "





13



Pinzetten

Forceps

Pinzas

Pinze



STANDARD

13-000-10	10,0 cm, 4 "
13-000-11	11,0 cm, 4 ³ / ₈ "
13-000-13	13,0 cm, 5 ¹ / ₈ "
13-000-14	14,5 cm, 5 ³ / ₄ "
13-000-16	16,0 cm, 6 ¹ / ₄ "
13-000-18	18,0 cm, 7 "
13-000-20	20,0 cm, 8 "
13-000-23	23,0 cm, 9 "
13-000-25	25,0 cm, 9 ³ / ₄ "
13-000-30	30,0 cm, 11 ³ / ₄ "



STANDARD

13-001-10	10,0 cm, 4 "
13-001-11	11,0 cm, 4 ³ / ₈ "
13-001-13	13,0 cm, 5 ¹ / ₈ "
13-001-14	14,5 cm, 5 ³ / ₄ "
13-001-16	16,0 cm, 6 ¹ / ₄ "
13-001-18	18,0 cm, 7 "
13-001-20	20,0 cm, 8 "
13-001-23	23,0 cm, 9 "
13-001-25	25,0 cm, 9 ³ / ₄ "
13-001-30	30,0 cm, 11 ³ / ₄ "

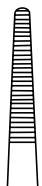

schmal
narrow
estrechos
stretti

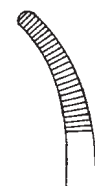

schmal
narrow
estrechos
stretti



STANDARD

13-002-10	10,0 cm, 4 "
13-002-11	11,0 cm, 4 ³ / ₈ "
13-002-13	13,0 cm, 5 ¹ / ₈ "
13-002-14	14,5 cm, 5 ³ / ₄ "
13-002-16	16,0 cm, 6 ¹ / ₄ "
13-002-18	18,0 cm, 7 "
13-002-20	20,0 cm, 8 "
13-002-25	25,0 cm, 9 ³ / ₄ "
13-002-30	30,0 cm, 11 ³ / ₄ "



STANDARD

13-003-10	10,0 cm, 4 "
13-003-11	11,0 cm, 4 ³ / ₈ "
13-003-13	13,0 cm, 5 ¹ / ₈ "
13-003-14	14,5 cm, 5 ³ / ₄ "
13-003-16	16,0 cm, 6 ¹ / ₄ "
13-003-18	18,0 cm, 7 "
13-003-20	20,0 cm, 8 "
13-003-25	25,0 cm, 9 ³ / ₄ "
13-003-30	30,0 cm, 11 ³ / ₄ "

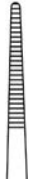

fein
 delicate
 finas
 fine

STANDARD

13-004-10	10,0 cm, 4 "
13-004-11	11,0 cm, 4 3/8 "
13-004-13	13,0 cm, 5 1/8 "
13-004-14	14,5 cm, 5 3/4 "
13-004-16	16,0 cm, 6 1/4 "
13-004-18	18,0 cm, 7 "
13-004-20	20,0 cm, 8 "



13-006-14

breites Modell
 wide pattern
 modelo ancho
 modello largo

13-006-14 14,5 cm, 5 3/4 "



13-008-09	10,5 cm, 3 1/2 "
13-008-10	10,5 cm, 4 1/4 "
13-008-11	11,5 cm, 4 1/2 "
13-008-13	13,0 cm, 5 1/8 "
13-008-14	14,5 cm, 5 3/4 "



13-009-09	10,5 cm, 3 1/2 "
13-009-10	10,5 cm, 4 1/4 "
13-009-11	11,5 cm, 4 1/2 "
13-009-13	13,0 cm, 5 1/8 "
13-009-14	14,5 cm, 5 3/4 "

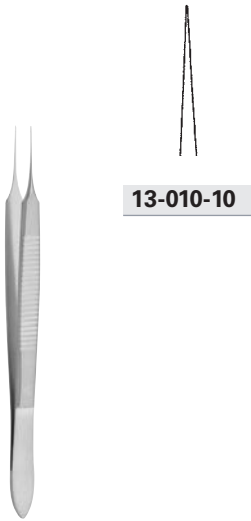

13-010-10

13-010-10 10,0 cm, 4 "



13-011-10

13-011-10 10,0 cm, 4 "

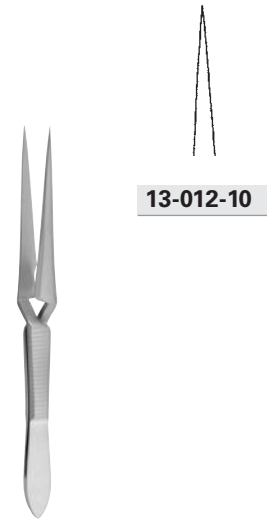

13-012-10

13-012-10 10,0 cm, 4 "



MOD. USA

13-020-12	12,0 cm, 4 ³ / ₄ "
13-020-13	13,0 cm, 5 ¹ / ₈ "
13-020-14	14,5 cm, 5 ³ / ₄ "
13-020-15	15,0 cm, 6 "
13-020-18	18,0 cm, 7 "
13-020-21	21,0 cm, 8 ¹ / ₄ "
13-020-25	25,0 cm, 9 ³ / ₄ "
13-020-31	31,0 cm, 12 ¹ / ₄ "



schmal
narrow
estrechos
stretti



MOD. USA

13-022-12	12,0 cm, 4 ³ / ₄ "
13-022-13	13,0 cm, 5 ¹ / ₈ "
13-022-14	14,5 cm, 5 ³ / ₄ "
13-022-15	15,0 cm, 6 "



STILLE

13-030-11	11,0 cm, 4 3/8"
13-030-13	13,0 cm, 5 1/8"
13-030-15	15,0 cm, 6"
13-030-17	17,0 cm, 6 3/4"
13-030-20	20,0 cm, 8"

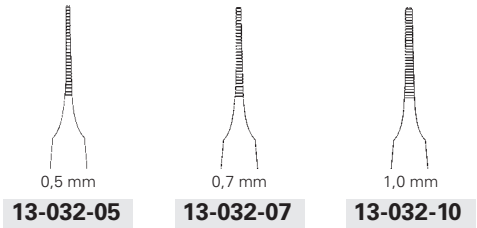

0,5 mm
13-032-05

0,7 mm
13-032-07

1,0 mm
13-032-10

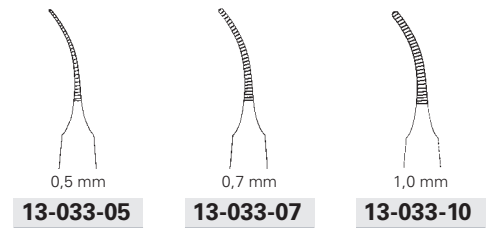

0,5 mm
13-033-05

0,7 mm
13-033-07

1,0 mm
13-033-10

Irispinzetten
 Iris forceps
 Pinzas para iridectomía
 Pinze per iridectomia

GRAEFE

13-032-05 - 13-033-07 7,0 cm, 2 3/4"

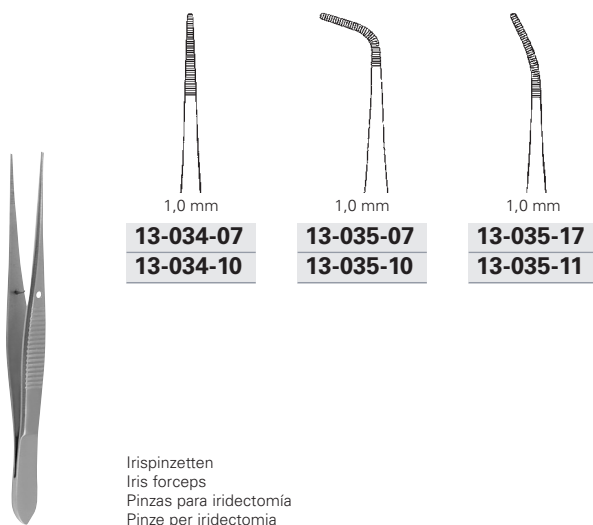

1,0 mm
13-034-07
13-034-10

1,0 mm
13-035-07
13-035-10

1,0 mm
13-035-17
13-035-11

Irispinzetten
 Iris forceps
 Pinzas para iridectomía
 Pinze per iridectomia

GRAEFE

13-034-07 - 13-035-17 7,0 cm, 2 3/4"
13-034-10 - 13-035-11 10,0 cm, 4"

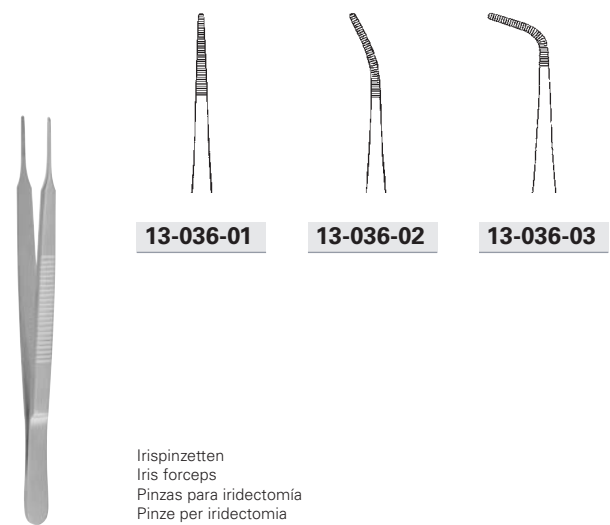

13-036-01

13-036-02

13-036-03

Irispinzetten
 Iris forceps
 Pinzas para iridectomía
 Pinze per iridectomia

STEVENS

13-036-01 - 13-036-03 10,5 cm, 4"



13-036-10

Nahtpinzette
Suture forceps
Pinza para sutura
Pinze per sutura

MOORFIELD

13-036-10 10,0 cm, 4 "



13-038-11

Nahtpinzette, schmal
Suture forceps, narrow
Pinza para sutura, estrechos
Pinze per sutura, stretti

BONACCOLTO

13-038-11 10,0 cm, 4 "



13-036-11

Nahtpinzette
Suture forceps
Pinza para sutura
Pinze per sutura

BONACCOLTO

13-036-11 10,0 cm, 4 "

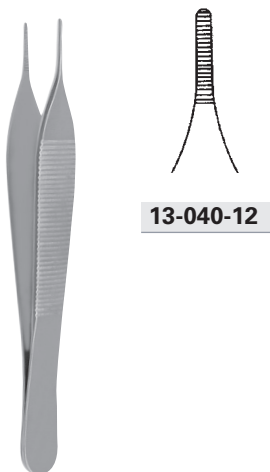

13-040-12

EWALD

13-040-12 12,0 cm, 4 3/4 "

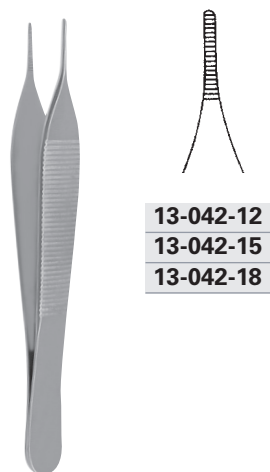

13-042-12
13-042-15
13-042-18

ADSON

13-042-12 12,0 cm, 4 3/4 "
13-042-15 15,0 cm, 6 "
13-042-18 18,0 cm, 7 "

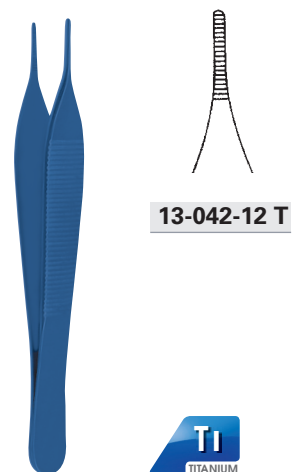

13-042-12 T

ADSON

13-042-12 T 12,0 cm, 4 3/4 "





13-044-12
 13-044-15

ADSON-MICRO

13-044-12 12,0 cm, 4 3/4 "
 13-044-15 15,0 cm, 6 "



13-046-12

ADSON

13-046-12 12,0 cm, 4 3/4 "



13-050-15

MC INDOE

13-050-15 15,0 cm, 6 "



13-050-15 T



MC INDOE

13-050-15 T 15,0 cm, 6 "



13-052-15

GILLIES

13-052-15 15,0 cm, 6 "



13-054-12 T



SEMKEN

13-054-12 T 12,0 cm, 4 3/4 "

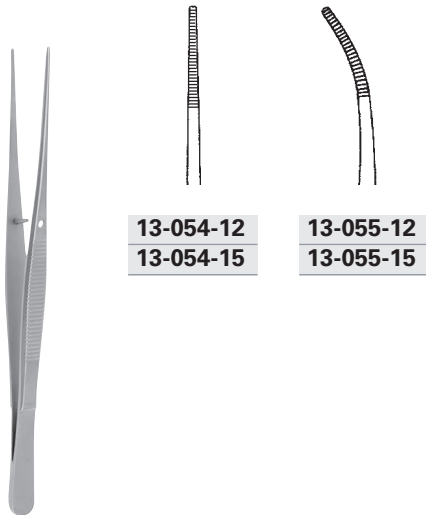

13-054-12
13-054-15

13-055-12
13-055-15

SEMKEN

13-054-12 - 13-055-12 12,0 cm, 4 3/4"
13-054-15 - 13-055-15 15,0 cm, 6"

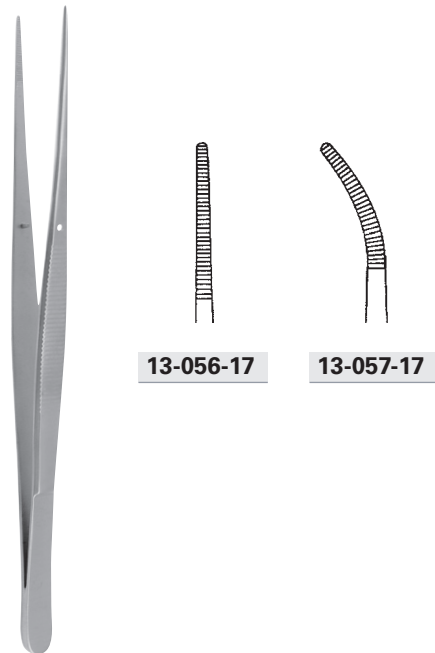

13-056-17

13-057-17

TAYLOR

13-056-17 - 13-057-17 17,0 cm, 6 3/4"

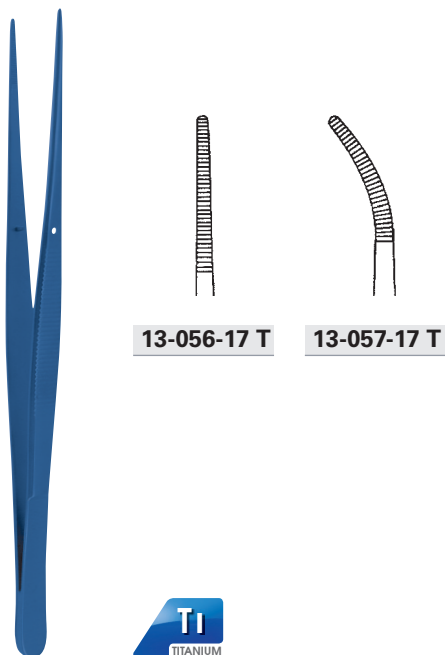

13-056-17 T

13-057-17 T



TAYLOR

13-056-17 T - 13-057-17 T 17,0 cm, 6 3/4"

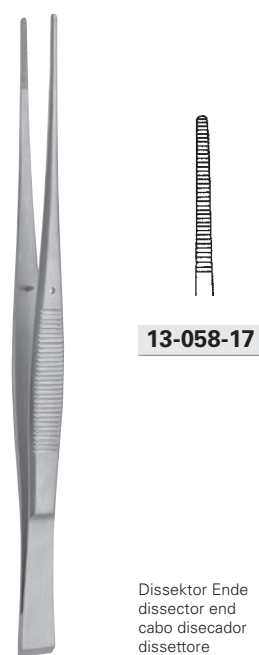

13-058-17

Dissektor Ende
dissector end
cabo disecador
dissettore

TAYLOR

13-058-17 17,0 cm, 6 3/4"

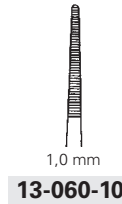
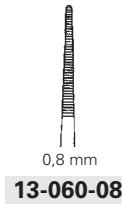
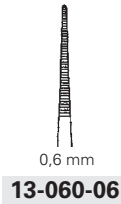

13-060-06 - 13-060-10 15,5 cm, 6 1/8"

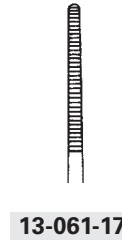

Dissektor Ende
 dissector end
 cabo disecador
 dissettore

TAYLOR

13-061-17 17,0 cm, 6 3/4"

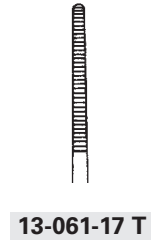

Dissektor Ende
 dissector end
 cabo disecador
 dissettore

TAYLOR

13-061-17 T 17,0 cm, 6 3/4"



POTTS-SMITH

13-064-18 - 13-065-18 18,0 cm, 7"
13-064-21 - 13-065-21 21,0 cm, 8 1/4"
13-064-25 - 13-065-25 25,0 cm, 9 3/4"
13-064-30 - 13-065-30 30,0 cm, 11 3/4"



POTTS-SMITH

13-064-18 T 18,0 cm, 7"
13-064-21 T 21,0 cm, 8 1/4"
13-064-25 T 25,0 cm, 9 3/4"



13-066-17



13-067-17

Dissektor Ende
dissector end
cabo disecador
dissetto

CUSHING

13-066-17 - 13-067-17 17,0 cm, 6 3/4"



13-068-20



13-069-20

BROPHY

13-068-20 - 13-069-20 20,0 cm, 8"



13-070-18
13-070-23

GERALD

13-070-18 18,0 cm, 7"
13-070-23 23,0 cm, 9"



13-070-18 T



GERALD

13-070-18 T 18,0 cm, 7"



13-071-18

GERALD

13-071-18 18,0 cm, 7"



13-072-20

DUEHRSEN

13-072-20 20,0 cm, 8"



13-074-14

OCHSNER

13-074-14 14,5 cm, 5 3/4"



13-074-18
 13-074-20

13-074-18 18,0 cm, 7"
 13-074-20 20,0 cm, 8"



13-075-18

BONNEY

13-075-18 18,0 cm, 7"



13-084-15
 13-084-20
 13-084-25
 13-084-30

Gewebefasspinzetten
 Tissue grasping forceps
 Pinzas para agarrar tejidos
 Pinze per afferrare tessuti

MOD. RUSSIAN

13-084-15 15,0 cm, 6"
 13-084-20 20,0 cm, 8"
 13-084-25 25,0 cm, 9 3/4"
 13-084-30 30,0 cm, 11 3/4"



13-084-23

Gewebefasspinzette
 Tissue grasping forceps
 Pinza para agarrar tejidos
 Pinze per afferrare tessuti

MAYO-RUSSIAN

13-084-23 23,0 cm, 9"



13-086-23

Gewebefasspinzette
Tissue grasping forceps
Pinza para agrrar tejidos
Pinze per afferrare tessuti



13-088-18
13-088-23

Gewebefasspinzette
Tissue grasping forceps
Pinza para agrrar tejidos
Pinze per afferrare tessuti



13-090-19

Gewebefasspinzette
Tissue grasping forceps
Pinza para agrrar tejidos
Pinze per afferrare tessuti



13-092-13
13-092-16

WANGENSTEEN

13-086-23 23,0 cm, 9"

SINGLEY-TUTTLE

13-088-18 18,0 cm, 7"

13-088-23 23,0 cm, 9"

DENNIS-BROWNE

13-090-19 19,0 cm, 7 1/2"

STANDARD

13-092-13 13,0 cm, 5 1/8"

13-092-16 16,0 cm, 6 1/4"



13-094-15
13-094-20
13-094-25

Fasspinzette
Tissue forceps
Pinza para agrrar
Pinze da presa



13-096-14

Fasspinzette
Tissue forceps
Pinza para agrrar
Pinze da presa

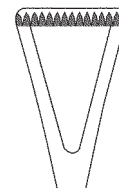

14,0 mm

13-098-01

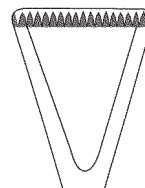

18,0 mm

13-098-02

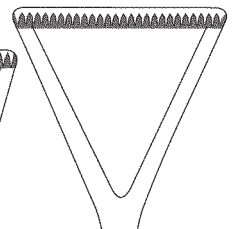

27,0 mm

13-098-03

Fasspinzetten
Tissue forceps
Pinzas para agrrar
Pinze da presa

SELMANN

13-094-15 16,0 cm, 6 1/4"

13-094-20 20,0 cm, 8"

13-094-25 25,0 cm, 9 3/4"

DUVAL

13-096-14 14,0 cm, 5 1/2"

COLLIN-DUVAL

13-098-01 - 13-098-03 20,0 cm, 8"

1 x 2



STANDARD

13-100-10	10,0 cm, 4 "
13-100-11	11,0 cm, 4 3/8 "
13-100-13	13,0 cm, 5 1/8 "
13-100-14	14,5 cm, 5 3/4 "
13-100-16	16,0 cm, 6 1/4 "
13-100-18	18,0 cm, 7 "
13-100-20	20,0 cm, 8 "
13-100-23	23,0 cm, 9 "
13-100-25	25,0 cm, 9 3/4 "
13-100-30	30,0 cm, 11 3/4 "

1 x 2



schmal
narrow
estrechos
stretti



STANDARD

13-102-11	11,0 cm, 4 3/8 "
13-102-13	13,0 cm, 5 1/8 "
13-102-14	14,5 cm, 5 3/4 "
13-102-16	16,0 cm, 6 1/4 "
13-102-18	18,0 cm, 7 "
13-102-20	20,0 cm, 8 "
13-102-25	25,0 cm, 9 3/4 "
13-102-30	30,0 cm, 11 3/4 "

1 x 2



schmal
narrow
estrechos
stretti



STANDARD

13-103-11	11,0 cm, 4 3/8 "
13-103-13	13,0 cm, 5 1/8 "
13-103-14	14,5 cm, 5 3/4 "
13-103-16	16,0 cm, 6 1/4 "
13-103-18	18,0 cm, 7 "
13-103-20	20,0 cm, 8 "
13-103-25	25,0 cm, 9 3/4 "
13-103-30	30,0 cm, 11 3/4 "

1 x 2



fein
delicate
finas
fine



STANDARD

13-104-13	13,0 cm, 5 1/8 "
13-104-14	14,5 cm, 5 3/4 "
13-104-16	16,0 cm, 6 1/4 "
13-104-18	18,0 cm, 7 "
13-104-20	20,0 cm, 8 "



1 x 2



13-106-18
13-106-20
13-106-25
13-106-30

WAUGH

13-106-18	18,0 cm, 7"
13-106-20	20,0 cm, 8"
13-106-25	25,0 cm, 9 3/4"
13-106-30	30,0 cm, 11 3/4"



1 x 2



13-108-14
13-108-16

mittel
medium
media
mezzo

STANDARD

13-108-14	14,0 cm, 5 1/2"
13-108-16	16,0 cm, 6 1/4"

2 x 3



MOD. USA

13-120-11	11,0 cm, 4 3/8"
13-120-13	13,0 cm, 5 1/8"
13-120-14	14,5 cm, 5 3/4"
13-120-15	15,0 cm, 6"
13-120-18	18,0 cm, 7"
13-120-20	20,0 cm, 8"
13-120-25	25,0 cm, 9 3/4"
13-120-30	30,0 cm, 11 3/4"

1 x 2



MOD. USA

13-122-12	12,0 cm, 4 3/4"
13-122-13	13,0 cm, 5 1/8"
13-122-14	14,5 cm, 5 3/4"
13-122-15	15,0 cm, 6"
13-122-18	18,0 cm, 7"
13-122-21	21,0 cm, 9 1/4"
13-122-25	25,0 cm, 9 3/4"
13-122-31	31,0 cm, 12 1/4"

2 x 3



STANDARD

13-124-11	11,0 cm, 4 $\frac{3}{8}$ "
13-124-13	13,0 cm, 5 $\frac{1}{8}$ "
13-124-14	14,0 cm, 5 $\frac{1}{2}$ "
13-124-15	15,0 cm, 6 $\frac{1}{8}$ "
13-124-16	16,0 cm, 6 $\frac{1}{4}$ "
13-124-18	18,0 cm, 7 "
13-124-20	20,0 cm, 8 "
13-124-25	25,0 cm, 9 $\frac{3}{4}$ "
13-124-30	30,0 cm, 11 $\frac{3}{4}$ "

3 x 4



STANDARD

13-126-13	13,0 cm, 5 $\frac{1}{8}$ "
13-126-14	14,0 cm, 5 $\frac{1}{2}$ "
13-126-15	15,0 cm, 6 $\frac{1}{8}$ "
13-126-16	16,0 cm, 6 $\frac{1}{4}$ "
13-126-20	20,0 cm, 8 "

4 x 5



13-128-13
13-128-14
13-128-16

STANDARD

13-128-13	13,0 cm, 5 $\frac{1}{8}$ "
13-128-14	14,0 cm, 5 $\frac{1}{2}$ "
13-128-16	16,0 cm, 6 $\frac{1}{4}$ "

1 x 2



13-129-15

STILLE

13-129-15	15,0 cm, 6 $\frac{1}{8}$ "
------------------	----------------------------

2 x 3



13-130-15

STILLE

13-130-15	15,0 cm, 6 $\frac{1}{8}$ "
------------------	----------------------------

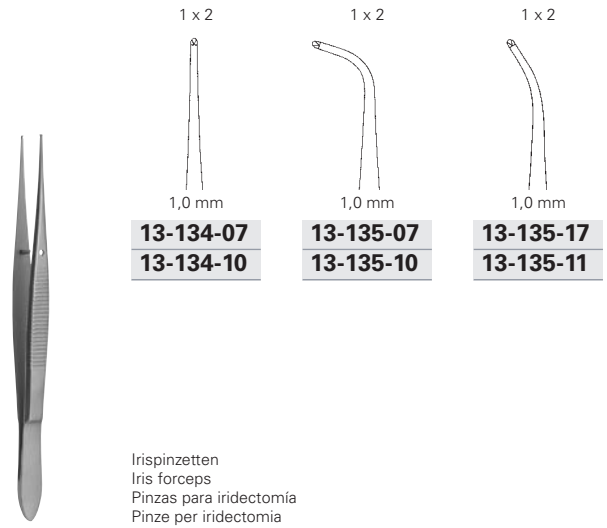
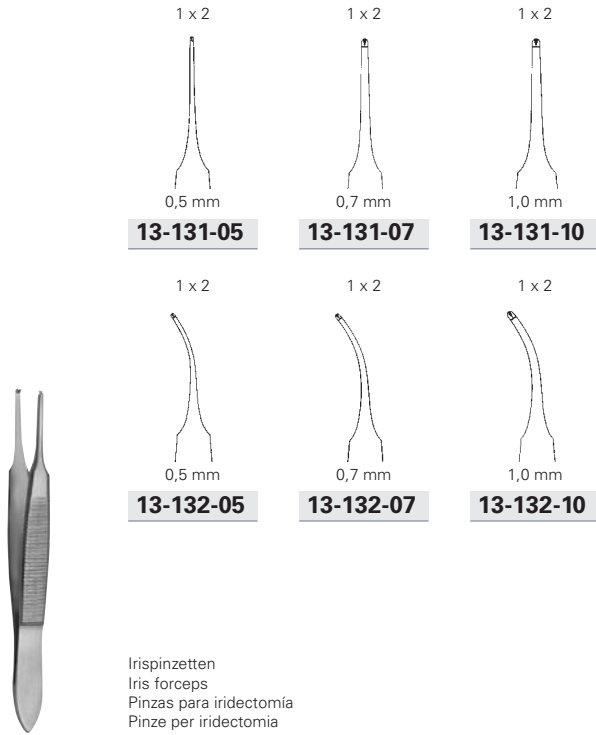

GRAEFE

13-131-05 - 13-131-07 7,0 cm, 2 3/4 "

GRAEFE

13-134-07 - 13-135-17 7,0 cm, 2 3/4 "

13-134-10 - 13-135-11 10,0 cm, 4 "

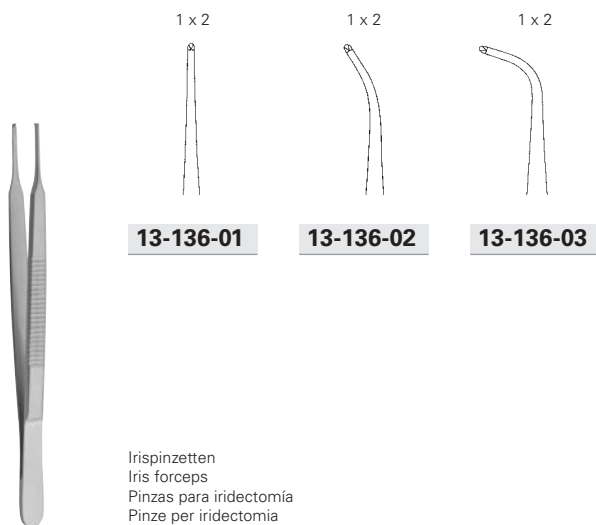

STEVENS

13-136-01 - 13-136-03 10,5 cm, 4 "

SEMKEN

13-136-10 10,0 cm, 4 "

13-136-11 11,0 cm, 4 3/8 "

13-136-12 12,5 cm, 5 "

13-136-14 14,5 cm, 5 3/4 "



13-138-10

Gewebefasspinzette
Tissue grasping forceps
Pinza para agrrar tejidos
Pinze per afferrare tessuti

GRAEFE

13-138-10 10,0 cm, 4 "



13-138-11

Gewebefasspinzette
Tissue grasping forceps
Pinza para agrrar tejidos
Pinze per afferrare tessuti

GRAEFE

13-138-11 10,0 cm, 4 "



13-140-12

1 x 2



EWALD

13-140-12 12,0 cm, 4 3/4 "



13-141-12
13-141-15

1 x 2



ADSON

13-141-12 12,0 cm, 4 3/4 "
13-141-15 15,0 cm, 6 "



13-142-12
13-142-15
13-142-18

1 x 2



ADSON

13-142-12 12,0 cm, 4 3/4 "
13-142-15 15,0 cm, 6 "
13-142-18 18,0 cm, 7 "



13-142-12 T

1 x 2



ADSON

13-142-12 T 12,0 cm, 4 3/4 "

2 x 3



13-142-22
13-142-25

ADSON

13-142-22 12,0 cm, 4 3/4"
13-142-25 15,0 cm, 6"

1 x 2



13-143-12

ADSON-MICRO

13-143-12 12,0 cm, 4 3/4"

1 x 2

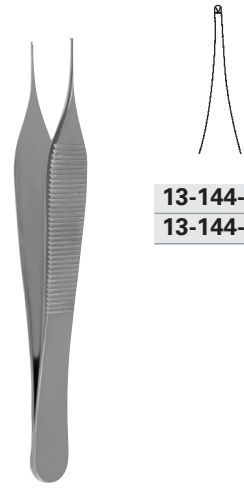

13-144-12
13-144-15

ADSON-MICRO

13-144-12 12,0 cm, 4 3/4"
13-144-15 15,0 cm, 6"

1 x 2



13-145-12

ADSON

13-145-12 12,0 cm, 4 3/4"

1 x 2



13-146-12

ADSON-MINI

13-146-12 12,0 cm, 4 3/4"

1 x 2

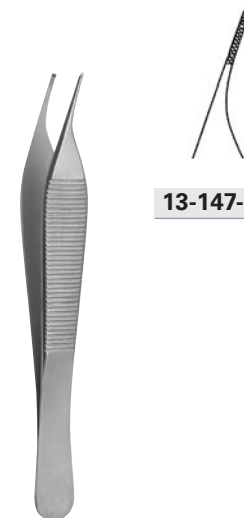

13-147-12

ADSON-MICRO

13-147-12 12,0 cm, 4 3/4"

1 x 2



13-148-12

ADSON-MICRO

13-148-12 12,0 cm, 4 3/4"

1 x 2



13-149-12

ADSON-BIEMER-MICRO

13-149-12 12,0 cm, 4 3/4"

1 x 2



13-150-15

MC INDOE

13-150-15 15,0 cm, 6"

1 x 2



13-152-15

GILLIES

13-152-15 15,0 cm, 6"

1 x 2



13-152-15 T

GILLIES

13-152-15 T 15,0 cm, 6"



1 x 2



13-152-16

GILLIES

13-152-16 15,5 cm, 6 1/8"

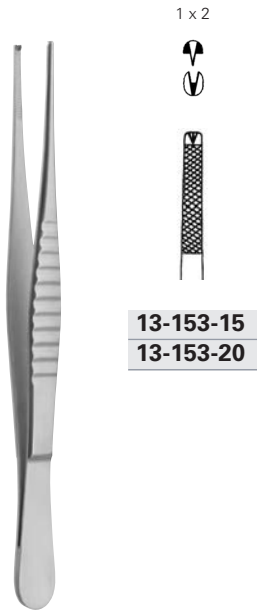

1 x 2



13-153-15
13-153-20

MOD. STRASSBURG

13-153-15 15,0 cm, 6"
13-153-20 20,0 cm, 8"

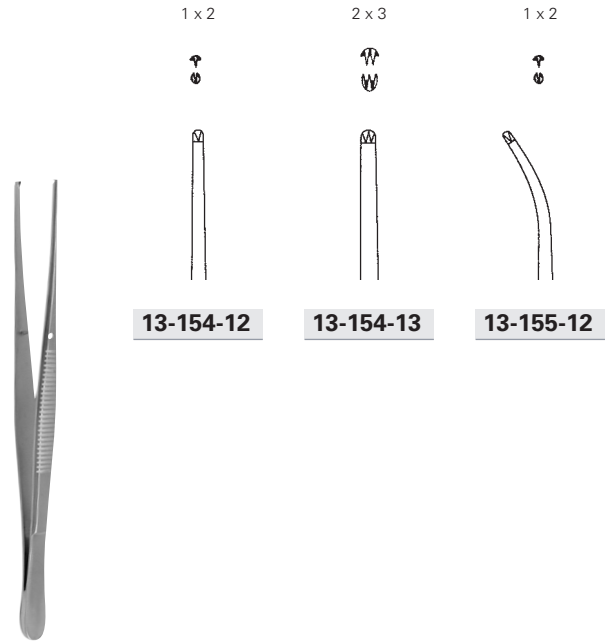

1 x 2



13-154-12

2 x 3



13-154-13

1 x 2



13-155-12

SEMKEN

13-154-12 - 13-155-12 12,5 cm, 5"

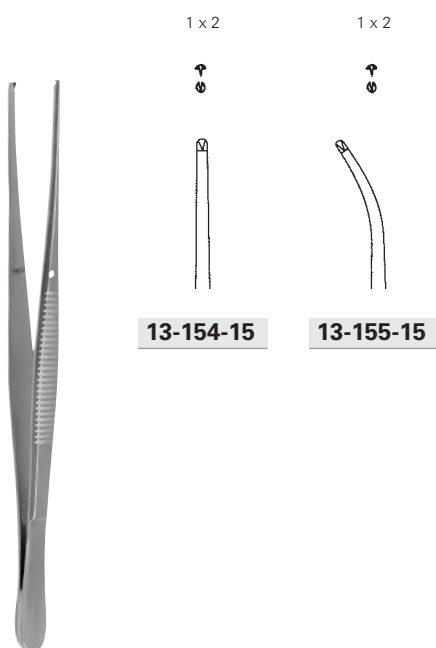

1 x 2



13-154-15

1 x 2



13-155-15

SEMKEN

13-154-15 - 13-155-15 15,0 cm, 6"

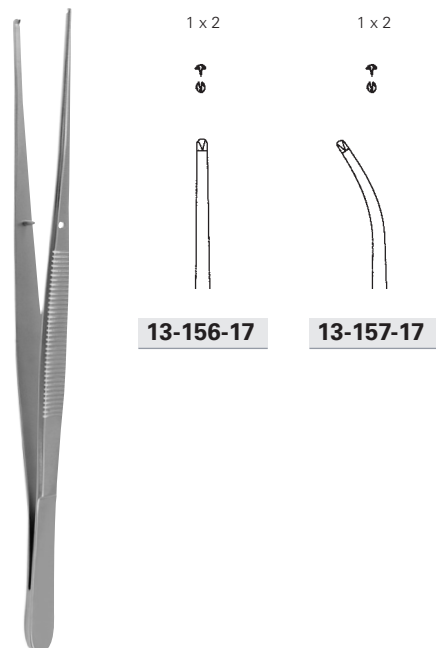

1 x 2



13-156-17

1 x 2



13-157-17

TAYLOR

13-156-17 - 13-157-17 17,0 cm, 6 3/4"

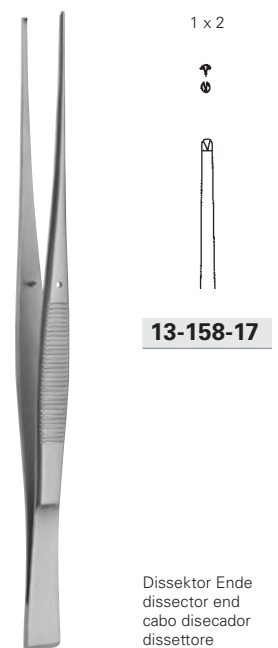

1 x 2



13-158-17

Dissektor Ende
dissector end
cabo disecador
dissettore

TAYLOR

13-158-17 17,0 cm, 6 3/4"

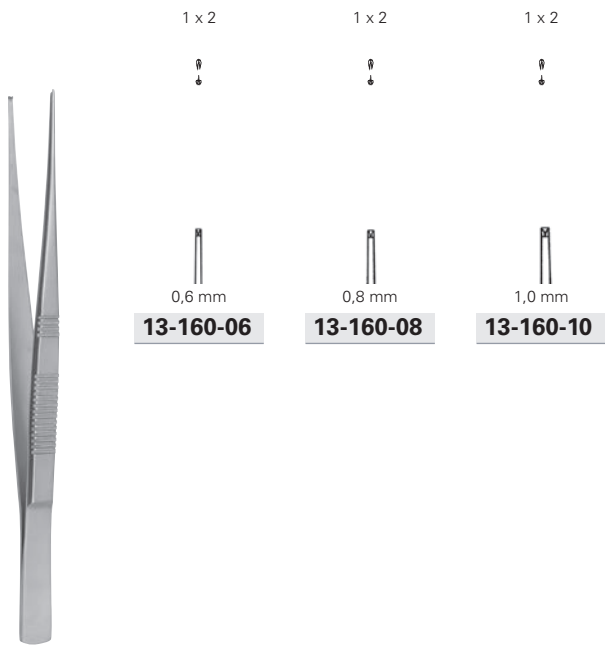

13-160-06

13-160-08

13-160-10

13-160-06 - 13-160-10 15,0 cm, 6 "



13-161-17

Dissektor Ende
dissector end
cabo disecador
dissettore

TAYLOR

13-161-17 17,0 cm, 6 3/4 "



13-161-17 T

Dissektor Ende
dissector end
cabo disecador
dissettore

TAYLOR

13-161-17 T 17,0 cm, 6 3/4 "

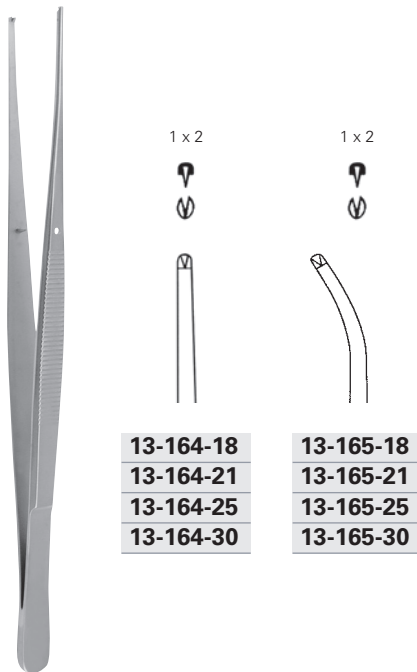

13-164-18
13-164-21
13-164-25
13-164-30

13-165-18
13-165-21
13-165-25
13-165-30

POTTS-SMITH

13-164-18 - 13-165-18 18,0 cm, 7 "
13-164-21 - 13-165-21 21,0 cm, 8 1/4 "
13-164-25 - 13-165-25 25,0 cm, 9 3/4 "
13-164-30 - 13-165-30 30,0 cm, 11 3/4 "

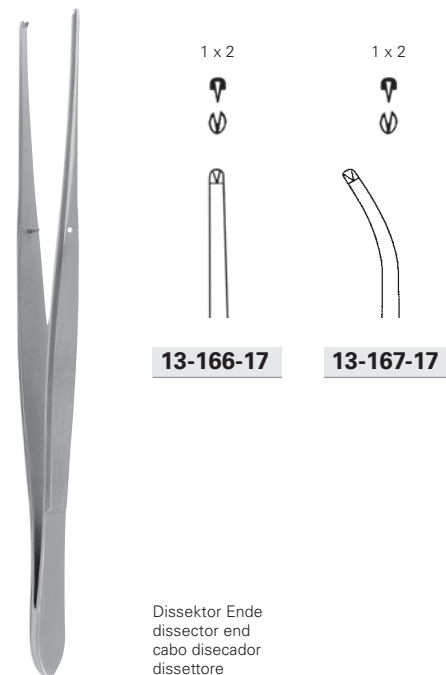

13-166-17

13-167-17

Dissektor Ende
dissector end
cabo disecador
dissettore

CUSHING

13-166-17 - 13-167-17 17,0 cm, 6 3/4 "



1 x 2



13-168-20

1 x 2



13-169-20

BROPHY

13-168-20 - 13-169-20 20,0 cm, 8 "



1 x 2



13-170-18
13-170-23

GERALD

13-170-18 18,0 cm, 7 "

13-170-23 23,0 cm, 9 "



1 x 2



13-170-18 T



GERALD

13-170-18 T 18,0 cm, 7 "



1 x 2



13-171-18

GERALD

13-171-18 18,0 cm, 7 "



4 x 5



13-172-15
13-172-20
13-172-25

Gefäß- und Tumorpinzetten
Vascular and tumor forceps
Pinzas para vasos y tumores
Pinza vascolare e per tumori

ADLERKREUTZ

13-172-15 15,0 cm, 6 "

13-172-20 20,0 cm, 9 "

13-172-25 25,0 cm, 9 3/4 "



2 x 3



13-173-15
13-173-20
13-173-25

Gefäß- und Tumorpinzetten
Vascular and tumor forceps
Pinzas para vasos y tumores
Pinza vascolare e per tumori

ADLERKREUTZ

13-173-15 15,0 cm, 6 "

13-173-20 20,0 cm, 9 "

13-173-25 25,0 cm, 9 3/4 "



2 x 3



13-174-18

1 x 2



13-175-18

BONNEY

13-174-18 - 13-175-18 18,0 cm, 7"



2 x 3



13-176-18

1 x 2



13-177-18

FERRIS-SMITH

13-176-18 - 13-177-18 18,0 cm, 7"



1 x 2



13-178-14
13-178-18

2 x 3



13-179-14
13-179-18

LANE

13-178-14 - 13-179-14 14,0 cm, 5 1/2"
13-178-18 - 13-179-18 18,0 cm, 7"



1 x 2



13-180-01

DUEHRSEN

13-180-01 20,0 cm, 8"



1 x 2



13-180-12
13-180-15

TREVES

13-180-12	12,0 cm, 4 3/4"
13-180-15	15,0 cm, 6"



3 x 4



13-182-18
13-182-20
13-182-25

Gefäß- und Tumorzinnetten
Vascular and tumor forceps
Pinzas para vasos y tumores
Pinza vascolare e per tumori

STILLE-BARRAYA

13-182-18	18,0 cm, 7"
13-182-20	20,0 cm, 9"
13-182-25	25,0 cm, 9 3/4"



6 x 7

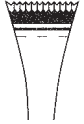

13-183-15
13-183-18
13-183-20
13-183-23

Lungenfasspinnetten
Lung grasping forceps
Pinzas para agrrar pulmón
Pinze per afferrare polmone

NELSON

13-183-15	15,0 cm, 6"
13-183-18	18,0 cm, 7"
13-183-20	20,0 cm, 8"
13-183-23	23,0 cm, 9"



13-185-17

Dissektor Ende
dissector end
cabo disecador
dissettore

TAYLOR-BROWN

13-185-17	17,0 cm, 6 3/4"
------------------	-----------------



13-186-17

Dissektor Ende
dissector end
cabo disecador
dissettore

CUSHING-BROWN

13-186-17	17,0 cm, 6 3/4"
------------------	-----------------



13-187-17

GERALD-BROWN

13-187-17	17,0 cm, 6 3/4"
------------------	-----------------



13-188-15
13-188-20
13-188-25

Gewebefasspinzetten
Tissue grasping forceps
Pinza para agarrar tejidos
Pinze per afferrare tessuti



9 x 9

9 x 9

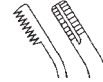

13-190-12

13-193-12

BROWN

13-188-15	15,0 cm, 6"
13-188-20	20,0 cm, 9"
13-188-25	25,0 cm, 9 3/4"

ADSON-BROWN

13-190-12 - 13-193-12 12,0 cm, 4 3/4"



9 x 9



13-190-12 T



ADSON-BROWN

13-190-12 T 12,0 cm, 4 3/4"



7 x 7



13-191-12
13-191-15

ADSON-BROWN

13-191-12 12,0 cm, 4 3/4"
13-191-15 15,0 cm, 6"



13-192-12

ADSON-GRAEFE

13-192-12 12,0 cm, 4 3/4"



4 x 5



13-194-15

STONE

13-194-15 15,0 cm, 6 "



5 x 6



13-196-15

LERCHE

13-196-15 15,0 cm, 6 "



6 x 7



13-198-14
13-198-16
13-198-20
13-198-25

Gefäß- und Tumorzangen
Vascular and tumor forceps
Pinzas para vasos y tumores
Pinza vascolare e per tumori

DURANTE

13-198-14 14,0 cm, 5 1/2 "
13-198-16 16,0 cm, 6 1/4 "
13-198-20 20,0 cm, 8 "
13-198-25 25,0 cm, 9 3/4 "



1,5 mm

13-200-01
13-200-02



ADSON-DE BAKLEY

13-200-01 12,0 cm, 4 3/4 "
13-200-02 15,0 cm, 6 "

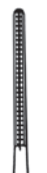

1,5 mm

13-200-02 T



ADSON-DE BAKLEY

13-200-02 T 15,0 cm, 6 "



4,0 mm

13-214-15



8,0 mm

13-214-24



GLASSMANN

13-214-15 15,0 cm, 6 "
13-214-24 24,0 cm, 9 1/2 "



DE BAKAY

Gesamtlänge Total length Longitud total Lunghezza totale					
16,5 cm, 6 1/2"	13-212-16	13-210-16	13-211-16	13-208-16	13-209-16
20,0 cm, 8"	13-212-20	13-210-20	13-211-20	13-208-20	13-209-20
24,0 cm, 9 1/2"	13-212-24	13-210-24	13-211-24	13-208-24	13-209-24
30,0 cm, 11 3/4"		13-210-30	13-211-30	13-208-30	13-209-30







DE BAKAY

COOLEY

Gesamtlänge Total length Longitud total Lunghezza totale					
16,5 cm, 6 1/2"	13-206-16	13-204-16	13-200-16	13-202-16	13-230-16
20,0 cm, 8"	13-206-20	13-204-20	13-200-20	13-202-20	13-230-20
24,0 cm, 9 1/2"	13-206-24	13-204-24	13-200-24	13-202-24	13-230-24
30,0 cm, 11 3/4"	13-206-30	13-204-30	13-200-30	13-202-30	







DE BAKEY

Gesamtlänge Total length Longitud total Lunghezza totale					
15,0 cm, 6 "	13-240-15	13-242-15	13-244-15	13-246-15	13-247-15
20,0 cm, 8 "	13-240-20	13-242-20	13-244-20	13-246-20	13-247-20
24,0 cm, 9 ½ "	13-240-24	13-242-24	13-244-24	13-246-24	13-247-24
30,0 cm, 11 ¾ "				13-246-30	13-247-30



DE BAKEY

COOLEY

Gesamtlänge Total length Longitud total Lunghezza totale					
16,5 cm, 6 ½ "	13-248-15		13-250-15	13-252-15	13-232-16 T
20,0 cm, 8 "	13-248-20	13-249-20	13-250-20	13-252-20	13-230-20 T
24,0 cm, 9 ½ "	13-248-24		13-250-24	13-252-24	13-230-24 T
30,0 cm, 11 ¾ "	13-248-30		13-250-30	13-252-30	

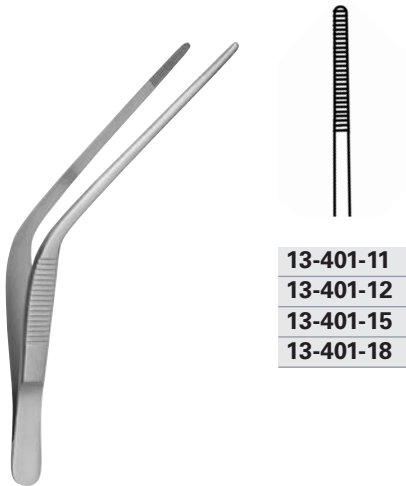

13-401-11
13-401-12
13-401-15
13-401-18

TROELTSCH

13-401-11	11,0 cm, 4 $\frac{3}{8}$ "
13-401-12	12,0 cm, 4 $\frac{3}{4}$ "
13-401-15	15,0 cm, 6 "
13-401-18	18,0 cm, 7 "

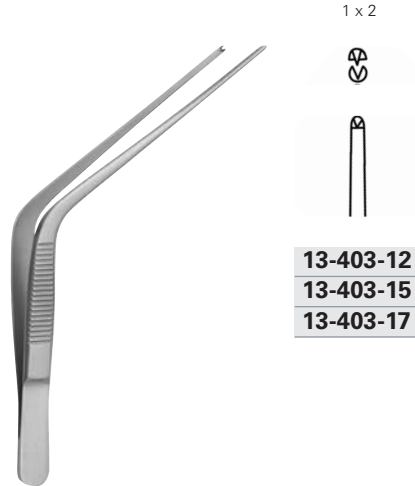

13-403-12
13-403-15
13-403-17

TROELTSCH

13-403-12	12,0 cm, 4 $\frac{3}{4}$ "
13-403-15	15,0 cm, 6 "
13-403-17	17,0 cm, 6 $\frac{3}{4}$ "



13-405-11
13-405-13

TROELTSCH-JALASVIRTA

13-405-11	11,0 cm, 4 $\frac{3}{8}$ "
13-405-13	13,0 cm, 5 $\frac{1}{8}$ "

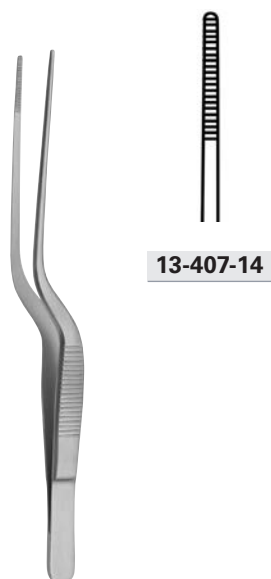

13-407-14

LUCAE

13-407-14	14,0 cm, 5 $\frac{1}{2}$ "
------------------	----------------------------

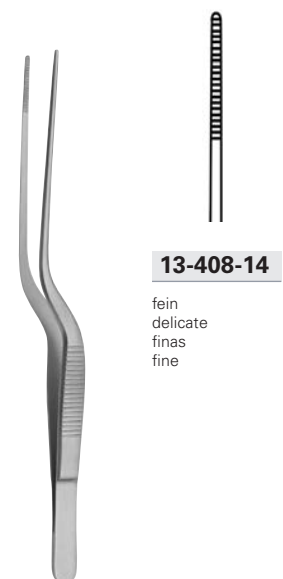

13-408-14

fein
 delicate
 finas
 fine

LUCAE

13-408-14	14,0 cm, 5 $\frac{1}{2}$ "
------------------	----------------------------

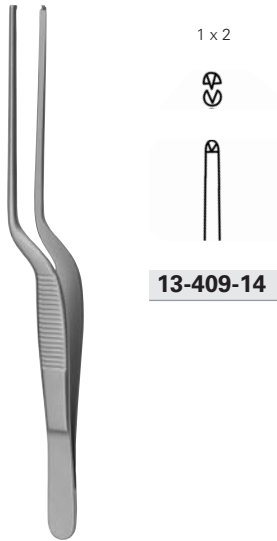

13-409-14

LUCAE

13-409-14 14,0 cm, 5 1/2"

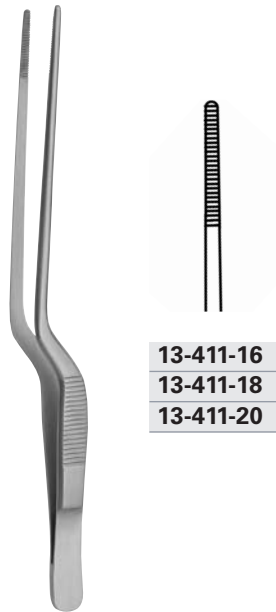

13-411-16
13-411-18
13-411-20

JANSEN

13-411-16 16,0 cm, 6 1/4"
13-411-18 18,0 cm, 7"
13-411-20 20,0 cm, 8"

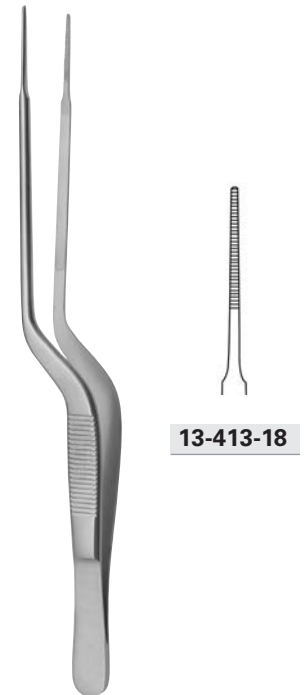

13-413-18

GERALD

13-413-18 18,0 cm, 7"

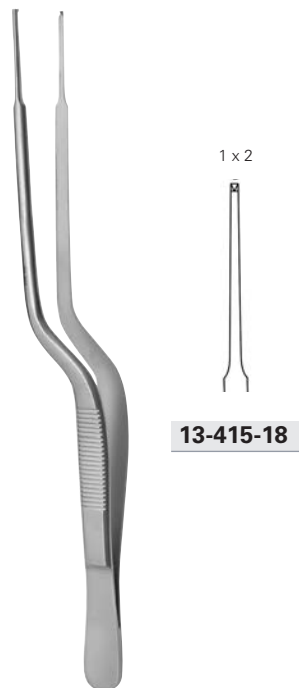

13-415-18

GERALD

13-415-18 18,0 cm, 7"

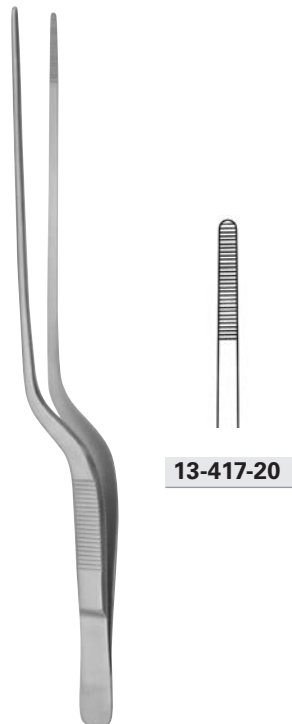

13-417-20

GRUENWALD-JANSEN

13-417-20 20,0 cm, 8"

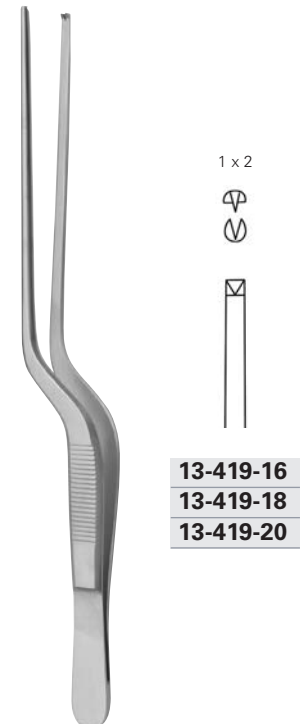

13-419-16
13-419-18
13-419-20

GRUENWALD-JANSEN

13-419-16 16,0 cm, 6 1/4"
13-419-18 18,0 cm, 7"
13-419-20 20,0 cm, 8"



13-500-09

DOUGLAS

13-500-09 9,0 cm, 3 1/2"



13-502-09

SHAAF

13-502-09 9,0 cm, 3 1/2"



13-504-09

BEER

13-504-09 9,0 cm, 3 1/2"



13-506-09

ZIEGLER

13-506-09 9,0 cm, 3 1/2"



13-508-09

13-508-09 9,0 cm, 3 1/2"



13-510-08

LITTAUER

13-510-08 8,5 cm, 3 1/3"



13-511-10

BARRAQUER

13-511-10 10,5 cm, 4 1/4"



13-512-08	8,0 cm, 3 1/8"
13-512-09	9,0 cm, 3 1/2"
13-512-10	10,0 cm, 4"
13-512-11	11,0 cm, 4 3/8"
13-512-12	12,0 cm, 4 3/4"
13-512-14	14,0 cm, 5 1/2"



13-513-08	8,0 cm, 3 1/8"
13-513-09	9,0 cm, 3 1/2"
13-513-10	10,0 cm, 4"
13-513-11	11,0 cm, 4 3/8"
13-513-12	12,0 cm, 4 3/4"
13-513-14	14,0 cm, 5 1/2"



13-514-08	8,0 cm, 3 1/8"
13-514-09	9,0 cm, 3 1/2"
13-514-10	10,0 cm, 4"
13-514-11	11,0 cm, 4 3/8"
13-514-12	12,0 cm, 4 3/4"
13-514-14	14,0 cm, 5 1/2"



13-515-08	8,0 cm, 3 1/8"
13-515-09	9,0 cm, 3 1/2"
13-515-10	10,0 cm, 4"
13-515-11	11,0 cm, 4 3/8"
13-515-12	12,0 cm, 4 3/4"
13-515-14	14,0 cm, 5 1/2"

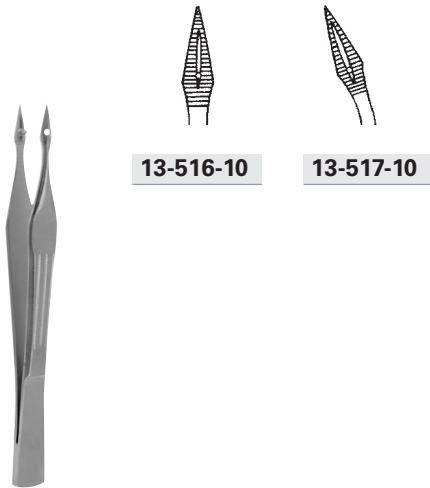

13-516-10

13-517-10

CARMALT

13-516-10 - 13-517-10 10,0 cm, 4 "

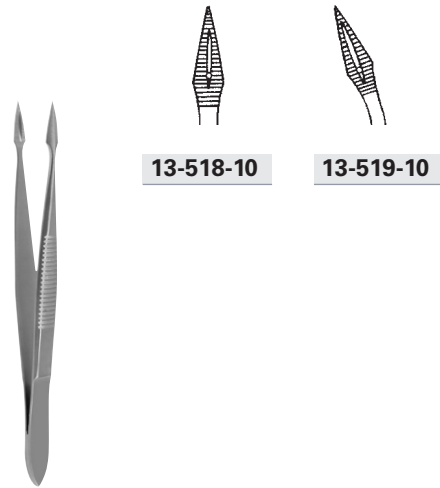

13-518-10

13-519-10

HUNTER

13-518-10 - 13-519-10 10,0 cm, 4 "

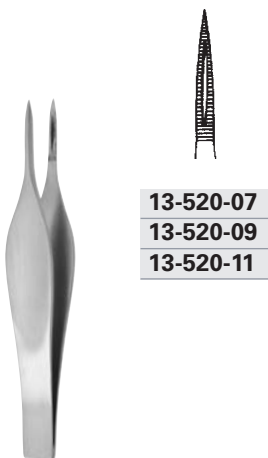

13-520-07

13-520-09

13-520-11

FEILCHENFELD

13-520-07 7,5 cm, 3 "

13-520-09 9,0 cm, 3 1/2 "

13-520-11 11,5 cm, 4 1/2 "

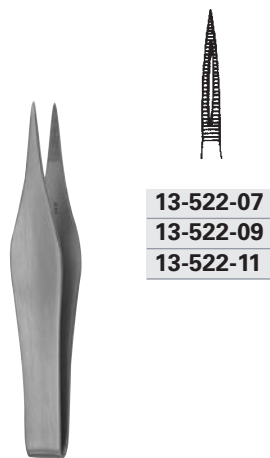

13-522-07

13-522-09

13-522-11

FEILCHENFELD

13-522-07 7,5 cm, 3 "

13-522-09 9,0 cm, 3 1/2 "

13-522-11 11,5 cm, 4 1/2 "



13-528-12 12,0 cm, 4 3/4 "



13-540-10



13-541-10

Deckglaspinzetten
Cover glass forceps
Pinzas porta-laminillas
Pinze porta-lamelle



Zeckenpinzetten
Ticks forceps
Pinzas garrapata
Pinze zecca



Zeckenpinzette
Ticks forceps
Pinza garrapata
Pinze zecca

KUEHNE

13-540-10 - 13-541-10 10,0 cm, 4 "

13-542-09 9,0 cm, 3 1/2 "

13-542-12 12,0 cm, 4 3/4 "

13-542-14 14,5 cm, 5 3/4 "



13-600-09

1 x 2

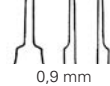
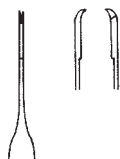

13-606-10

1 x 2

0,9 mm

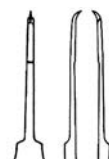

13-607-10

1 x 2

0,5 mm



13-614-09

1 x 2

0,2 mm

13-614-11

CASTROVIEJO

13-600-09 9,5 cm, 3 3/4 "

13-606-10 - 13-607-10 10,0 cm, 4 "

13-614-09 9,5 cm, 3 3/4 "

13-614-11 11,0 cm, 4 3/8 "

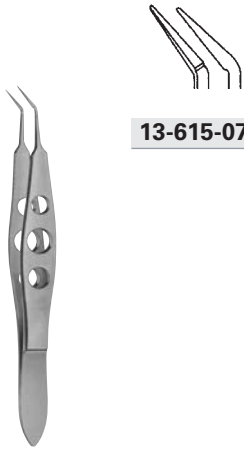

13-615-07

KELMAN-MC PHERSON

13-615-07 10,0 cm, 4 "



13-680-07

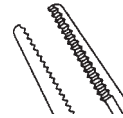

13-681-07



BONN

13-680-07 - 13-681-07 7,5 cm, 3 "



13-682-10



TUEBINGEN

13-682-10 10,0 cm, 4 "



13-684-07



BONN

13-684-07 7,0 cm, 2 3/4 "



13-686-07



BONN

13-686-07 7,0 cm, 2 3/4 "



13-688-10



BONN

13-688-10 10,0 cm, 4 "



FIG. 1

13-616-01 12,0 cm, 4 ³/₄ "



FIG. 2

13-616-02 12,0 cm, 4 ³/₄ "



FIG. 3

13-616-03 12,0 cm, 4 ³/₄ "



FIG. 4

13-616-04 11,0 cm, 4 ³/₈ "



FIG. 5

13-616-05 11,0 cm, 4 ³/₈ "



FIG. 5A

13-616-15 11,0 cm, 4 ³/₈ "



FIG. 5

13-616-45 10,5 cm, 4 ¹/₄ "



FIG. 5

13-616-90 10,5 cm, 4 ¹/₄ "

13-616-91 11,0 cm, 4 ³/₈ "



FIG. 7

13-617-07 11,5 cm, 4 ¹/₂ "



13-617-08 11,5 cm, 4 ¹/₂ "



13-617-09 13,5 cm, 5 ¹/₄ "



13



Mikro Instrumente

Micro Instruments

Instrumentos de micro

Strumentario micro

Fordern Sie unser Spezialprospekt an
Please ask for our special catalogue
No duden pedirnos más catálogos especiales
Chiedete i nostri cataloghi speciali



14



Pinzetten mit
Hartmetalleinlagen

Forceps with
tungsten carbide inserts

Pinzas con bocas
de carburo tungsteno

Pinze con morsi
in carburo di tungsteno

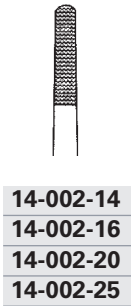

14-002-14
14-002-16
14-002-20
14-002-25



STANDARD

14-002-14	14,0 cm, 5 1/2"
14-002-16	16,0 cm, 6 1/4"
14-002-20	20,0 cm, 8"
14-002-25	25,0 cm, 9 3/4"



14-004-14
14-004-18
14-004-20
14-004-25



fein
delicate
finas
fine

STANDARD

14-004-14	14,0 cm, 5 1/2"
14-004-18	18,0 cm, 7"
14-004-20	20,0 cm, 8"
14-004-25	25,0 cm, 9 3/4"



14-044-12
14-044-15



ADSON

14-044-12	12,0 cm, 4 3/4"
14-044-15	15,0 cm, 6"



14-046-12



ADSON-MICRO

14-046-12	12,0 cm, 4 3/4"
-----------	-----------------



14-050-15



MC INDOE

14-050-15	15,0 cm, 6"
-----------	-------------



14-054-12
14-054-15



SEMKEN

14-054-12	12,0 cm, 4 3/4"
14-054-15	15,0 cm, 6"

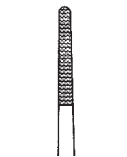

14-061-18



Dissektor Ende
 dissector end
 cabo disecador
 dissettore

CUSHING

14-061-18 18,0 cm, 7 "

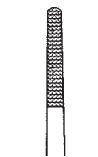

POTTS-SMITH

14-064-15	15,0 cm, 6 "
14-064-18	18,0 cm, 7 "
14-064-20	20,0 cm, 8 "
14-064-23	23,0 cm, 9 "
14-064-25	25,0 cm, 9 3/4 "



14-066-18
 14-066-23

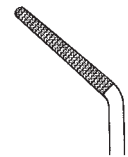

14-067-18



Dissektor Ende
 dissector end
 cabo disecador
 dissettore

CUSHING

14-066-18 - 14-067-18	18,0 cm, 7 "
14-066-23	23,0 cm, 9 "



14-070-18



GERALD

14-070-18 18,0 cm, 7 "



14-075-18



BONNEY

14-075-18 18,0 cm, 7 "



14-086-15
 14-086-23
 14-086-25



WANGENSTEEN

14-086-15	15,0 cm, 6 "
14-086-23	23,0 cm, 9 "
14-086-25	25,0 cm, 9 3/4 "



STANDARD

14-102-14	14,0 cm, 5 1/2 "
14-102-16	16,0 cm, 6 1/4 "
14-102-18	18,0 cm, 7 "
14-102-20	20,0 cm, 8 "
14-102-25	25,0 cm, 9 3/4 "

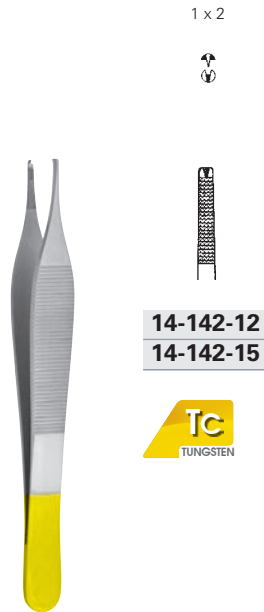

ADSON

14-142-12	12,0 cm, 4 3/4 "
14-142-15	15,0 cm, 6 "

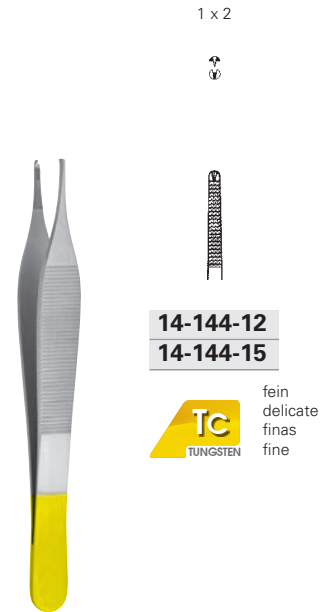

ADSON

14-144-12	12,0 cm, 4 3/4 "
14-144-15	15,0 cm, 6 "

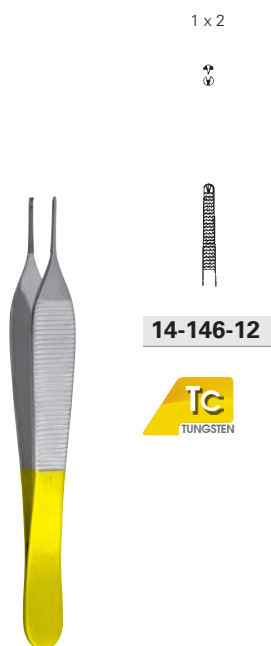

ADSON-MICRO

14-146-12	12,0 cm, 4 3/4 "
------------------	------------------

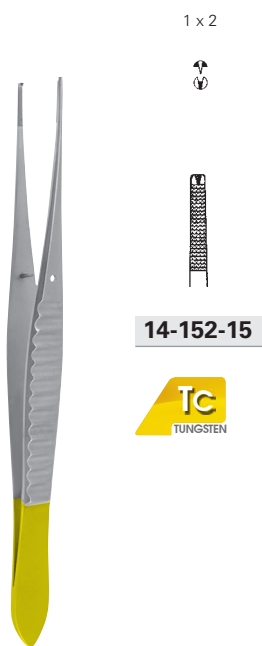

GILLIES

14-152-15	15,0 cm, 6 "
------------------	--------------

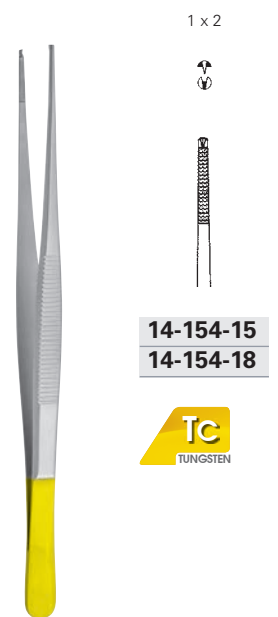

SEMKEN

14-154-15	15,0 cm, 6 "
14-154-18	18,0 cm, 7 "

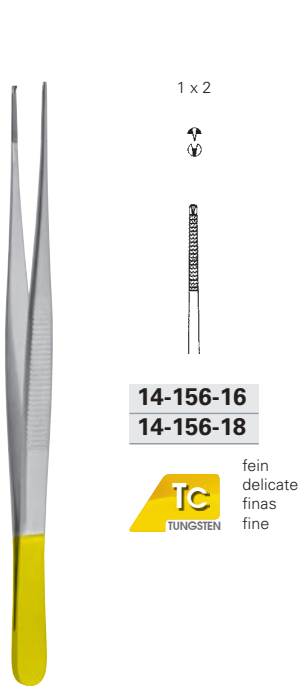

14-156-16
14-156-18

Tc
TUNGSTEN
fein
delicate
finas
fine

SEMKEN

14-156-16 16,0 cm, 6 1/4"
14-156-18 18,0 cm, 7"

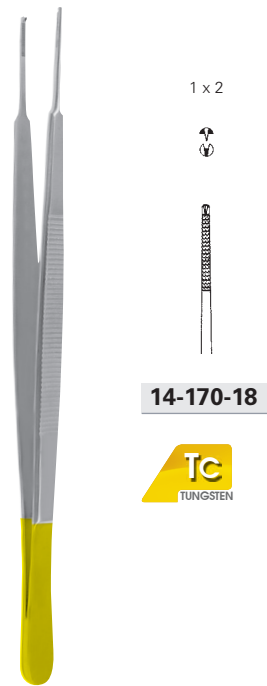

14-170-18

Tc
TUNGSTEN

GERALD

14-170-18 18,0 cm, 7"

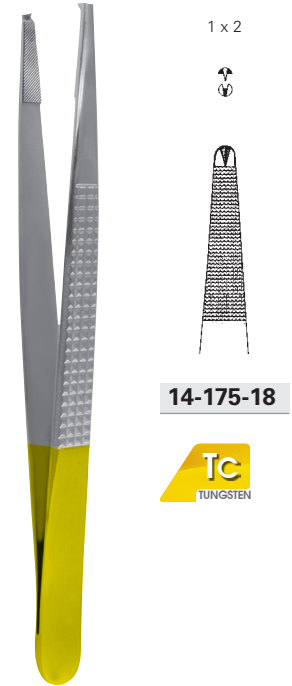

14-175-18

Tc
TUNGSTEN

BONNEY

14-175-18 18,0 cm, 7"

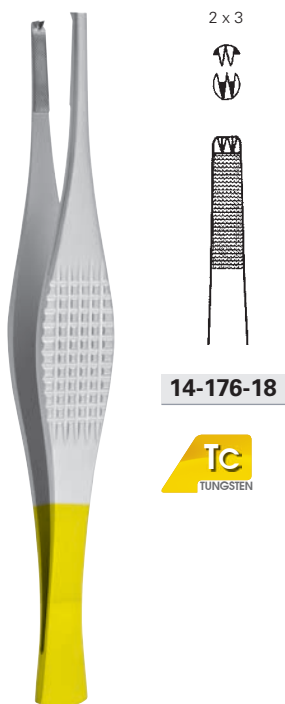

14-176-18

Tc
TUNGSTEN

FERRIS-SMITH

14-176-18 18,0 cm, 7"



14-190-12

Tc
TUNGSTEN

14-191-12

Tc
TUNGSTEN

ADSON-BROWN

14-190-12 - 14-191-12 12,0 cm, 4 3/4"



14-191-15

Tc
TUNGSTEN

ADSON-BROWN

14-191-15 15,0 cm, 6"



14-200-20

Nahtpinzette
Suture forceps
Pinza para sutura
Pinze per sutura



14-200-20 20,0 cm, 8 "



2,0 mm

14-208-16

14-208-20

14-208-24



DE BAKAY

14-208-16 16,0 cm, 6 ¼ "

14-208-20 20,0 cm, 8 "

14-208-24 24,0 cm, 9 ½ "



1,5 mm

14-210-16

14-210-20

14-210-24



DE BAKAY

14-210-16 16,0 cm, 6 ¼ "

14-210-20 20,0 cm, 8 "

14-210-24 24,0 cm, 9 ½ "



15



Arterienklemmen

Artery forceps,
Haemostatic forceps

Pinzas haemostaticas

Pinze emostatiche

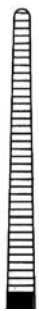

15-000-14



15-000-16



15-000-18

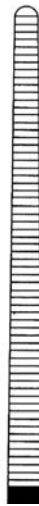

15-000-20



15-000-22



15-000-24



15-000-26



15-000-28

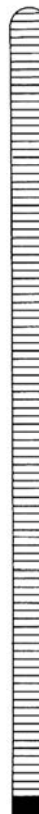

15-000-30



15-000-36



15-000-40



PEAN

15-000-14	14,0 cm, 5 1/2 "
15-000-16	16,0 cm, 6 1/4 "
15-000-18	18,0 cm, 7 "
15-000-20	20,0 cm, 8 "
15-000-22	22,0 cm, 8 3/4 "
15-000-24	24,0 cm, 9 1/2 "
15-000-26	26,0 cm, 10 1/4 "
15-000-28	28,0 cm, 11 "
15-000-30	30,0 cm, 11 3/4 "
15-000-36	36,0 cm, 14 1/4 "
15-000-40	40,0 cm, 16 "

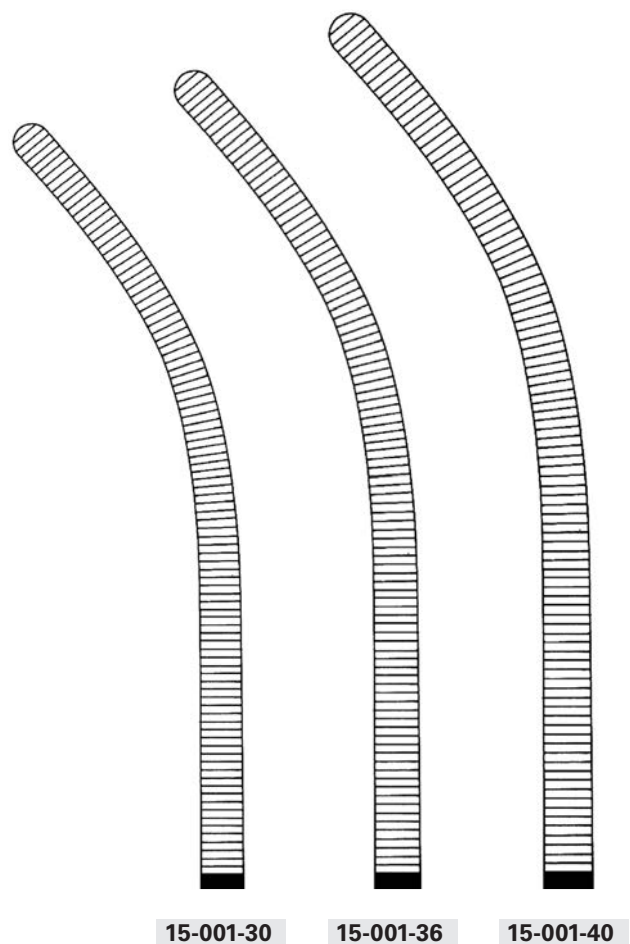
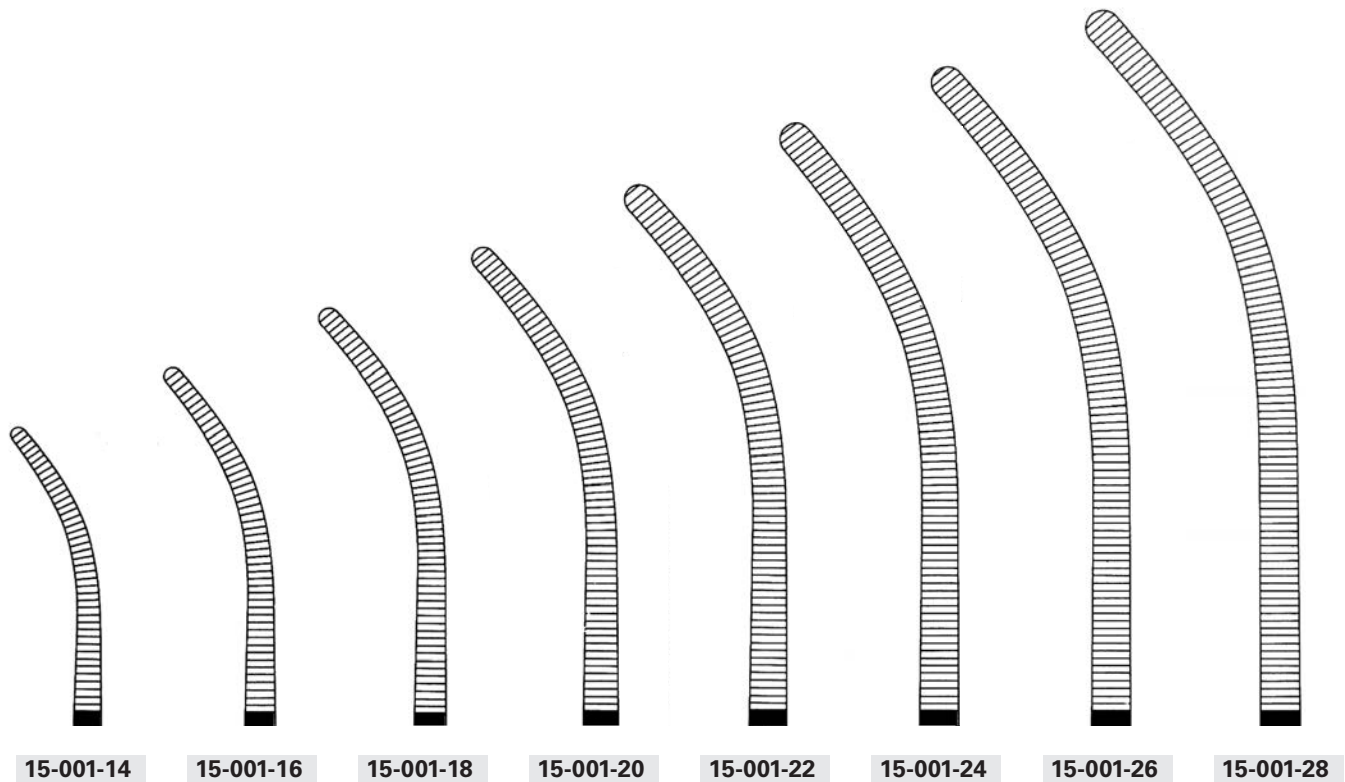

PEAN

15-001-14	14,0 cm, 5 1/2"
15-001-16	16,0 cm, 6 1/4"
15-001-18	18,0 cm, 7"
15-001-20	20,0 cm, 8"
15-001-22	22,0 cm, 8 3/4"
15-001-24	24,0 cm, 9 1/2"
15-001-26	26,0 cm, 10 1/4"
15-001-28	28,0 cm, 11"
15-001-30	30,0 cm, 11 3/4"
15-001-36	36,0 cm, 14 1/4"
15-001-40	40,0 cm, 16"

15-001-30

15-001-36

15-001-40



15-002-24



15-003-24



15-006-12



PEAN

15-002-24 - 15-003-24 24,0 cm, 9 1/2"

PEAN

15-006-12 12,5 cm, 5"



15-008-12



15-008-16



15-008-18



15-012-12



15-012-14



15-012-16



PEAN

15-008-12 12,5 cm, 5"
15-008-16 16,5 cm, 6 1/2"
15-008-18 18,5 cm, 7 1/4"

PEAN

15-012-12 12,5 cm, 5"
15-012-14 14,0 cm, 5 1/2"
15-012-16 16,0 cm, 6 1/4"

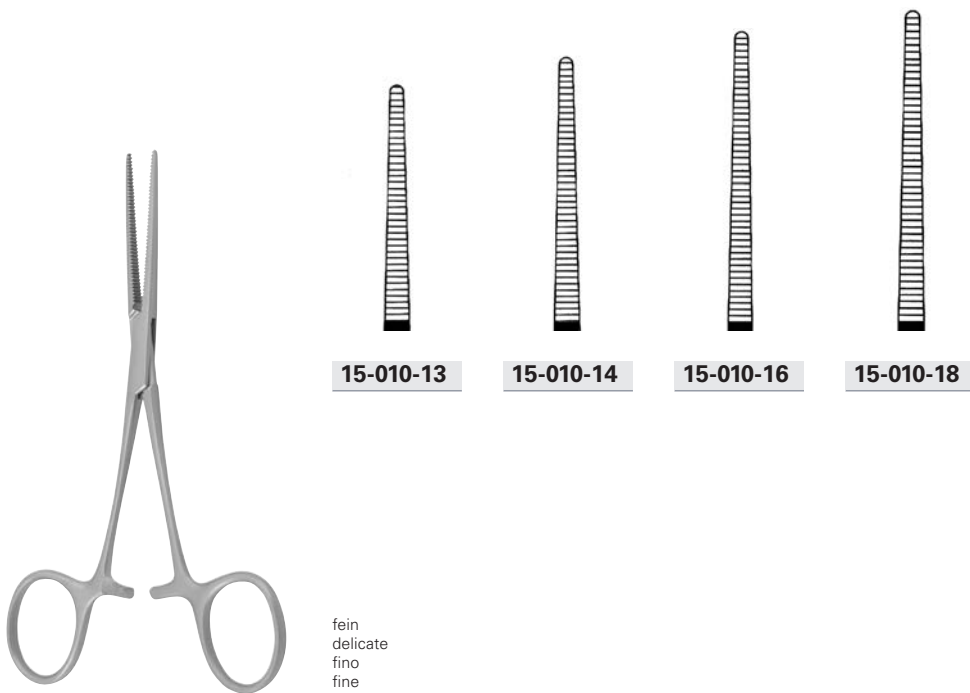

fein
 delicate
 fino
 fine

PEAN

15-010-13	13,0 cm, 5 1/8 "
15-010-14	14,0 cm, 5 1/2 "
15-010-16	16,0 cm, 6 1/4 "
15-010-18	18,0 cm, 7 "

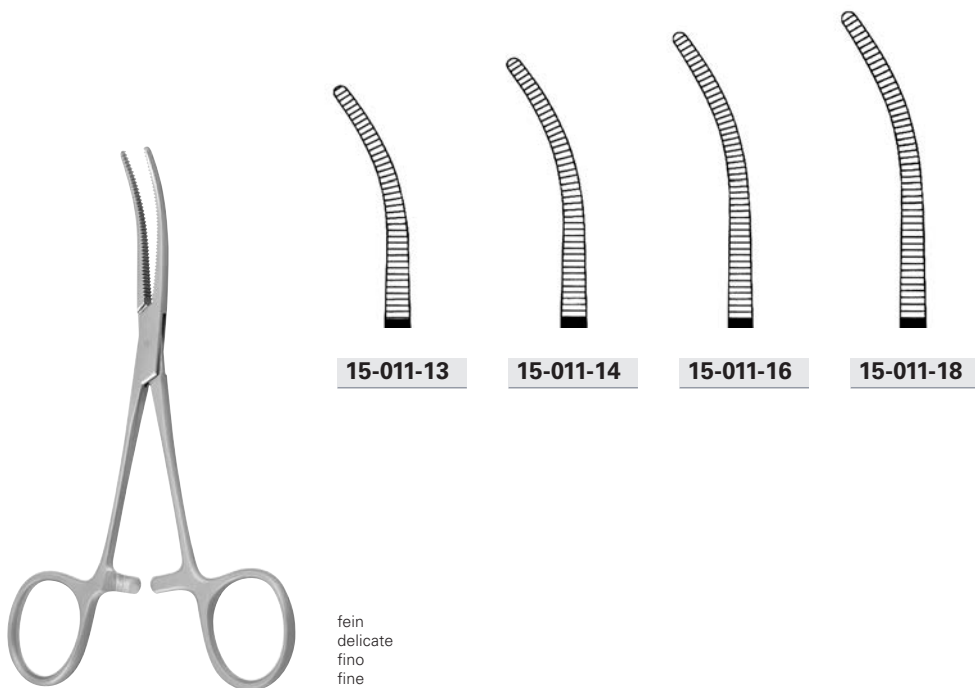

fein
 delicate
 fino
 fine

PEAN

15-011-13	13,0 cm, 5 1/8 "
15-011-14	14,0 cm, 5 1/2 "
15-011-16	16,0 cm, 6 1/4 "
15-011-18	18,0 cm, 7 "



15-014-13



15-014-14



15-014-15



15-014-18



15-014-20

SPENCER-WELLS

15-014-13	13,0 cm, 5 1/8"
15-014-14	14,0 cm, 5 1/2"
15-014-15	15,0 cm, 6"
15-014-18	18,0 cm, 7"
15-014-20	20,0 cm, 8"



15-015-13



15-015-14



15-015-15



15-015-18



15-015-20



15-015-23

SPENCER-WELLS

15-015-13	13,0 cm, 5 1/8"
15-015-14	14,0 cm, 5 1/2"
15-015-15	15,0 cm, 6"
15-015-18	18,0 cm, 7"
15-015-20	20,0 cm, 8"
15-015-23	23,0 cm, 9"



15-017-18

NISSEN

15-017-18 18,5 cm, 7 ¼"

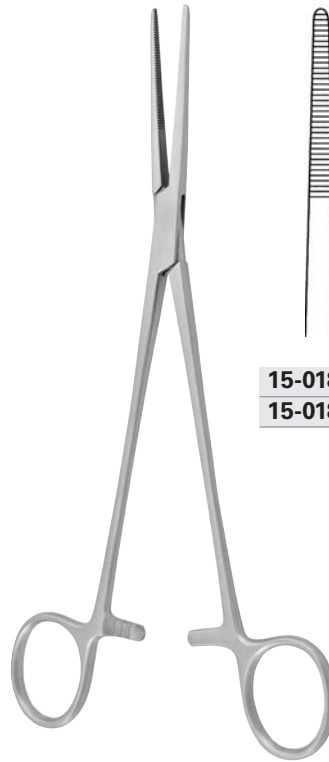

15-018-21
15-018-26

15-019-21
15-019-26

TOENNIS

15-018-21 - 15-019-21 21,0 cm, 8 ¼"
 15-018-26 - 15-019-26 26,0 cm, 10 ¼"



15-020-01
15-020-02

15-020-03
15-020-04

BENGOLEA (MOD. FRENCH)

15-020-01 - 15-020-03 18,0 cm, 7 "
 15-020-02 - 15-020-04 23,0 cm, 9 "

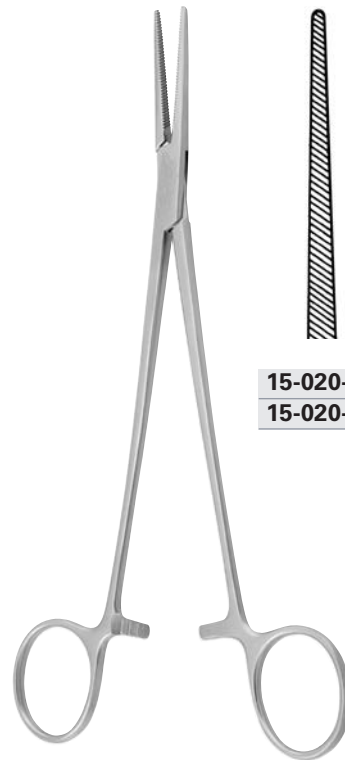

15-020-20
15-020-26

15-021-20
15-021-26

BENGOLEA

15-020-20 - 15-021-20 20,0 cm, 8 "
 15-020-26 - 15-021-26 26,0 cm, 10 ¼"

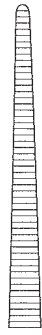

15-022-20

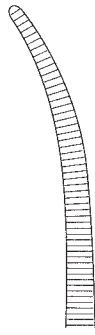

15-023-20

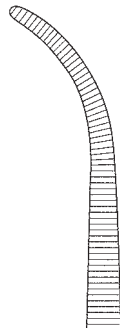

15-025-20

HEISS

15-022-20 - 15-025-20 20,0 cm, 8"

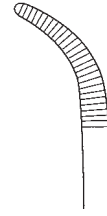

15-029-18

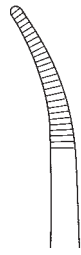

15-029-19

SCHNIDT

15-029-18 18,0 cm, 7"

15-029-19 19,0 cm, 7 1/2"

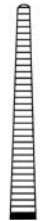
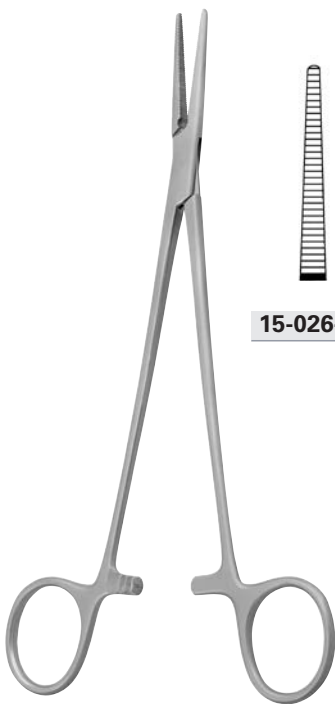

15-026-18



15-026-21



15-027-18



15-027-21

HALSTED-MOSQUITO

15-026-18 - 15-027-18 18,0 cm, 7"

15-026-21 - 15-027-21 21,0 cm, 8 1/4"



15-030-18



15-031-19

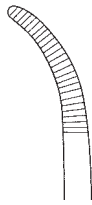

ADSON

- 15-030-18 18,5 cm, 7 ¼"
- 15-031-19 19,0 cm, 7 ½"



15-033-14



MICRO-ADSON

- 15-033-14 14,0 cm, 5 ½"



15-034-16



15-034-20

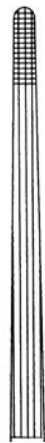

15-035-16



15-035-20



ROCHESTER-CARMALT

- 15-034-16 - 15-035-16 16,0 cm, 6 ¼"
- 15-034-20 - 15-035-20 20,0 cm, 8"

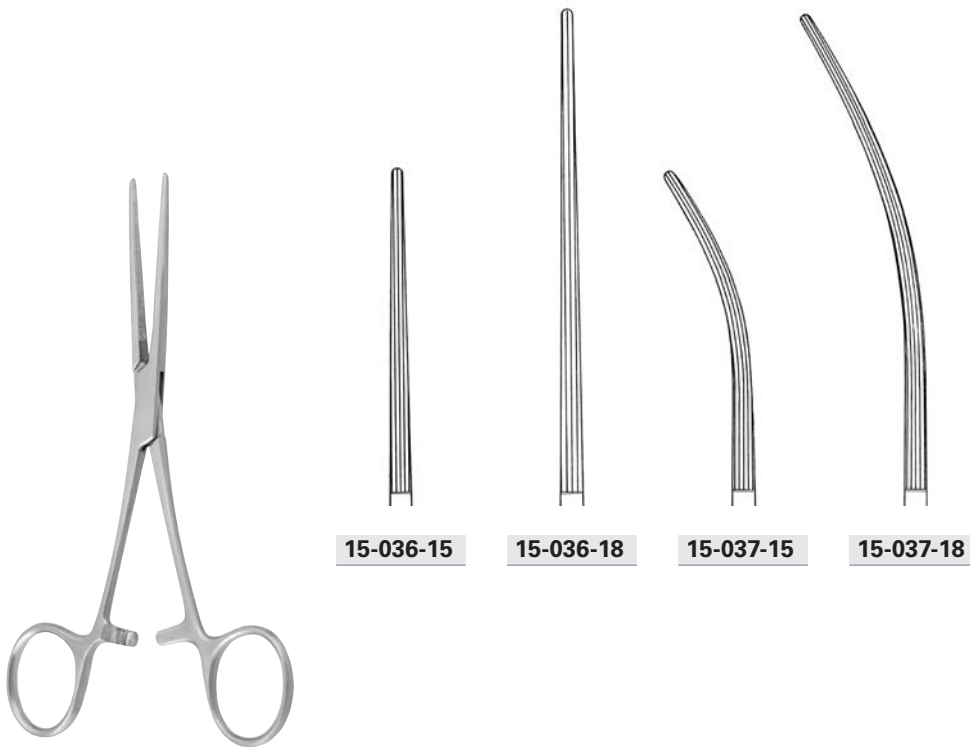

BAINBRIDGE

15-036-15 - 15-037-15 15,0 cm, 6 "

15-036-18 - 15-037-18 18,0 cm, 7 "

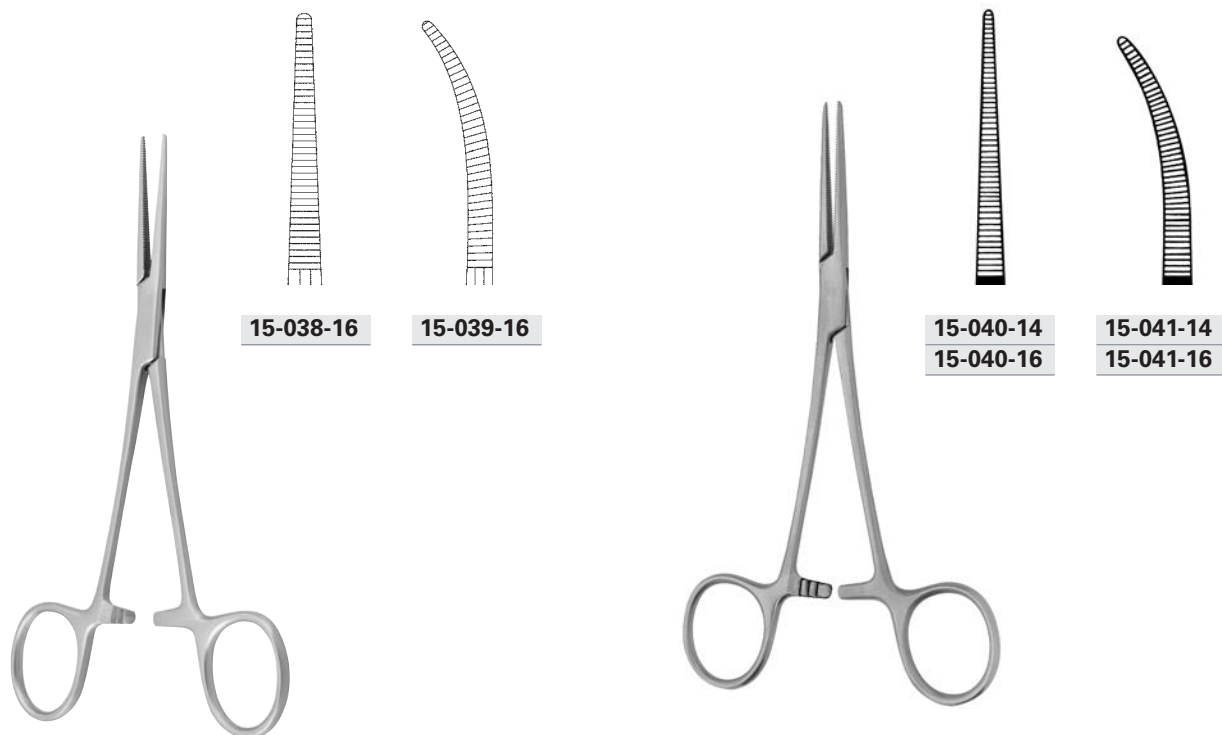

CRILE-RANKIN

15-038-16 - 15-039-16 16,0 cm, 6 ¼ "

COLLER

15-040-14 - 15-041-14 14,0 cm, 5 ½ "

15-040-16 - 15-041-16 16,0 cm, 6 ¼ "

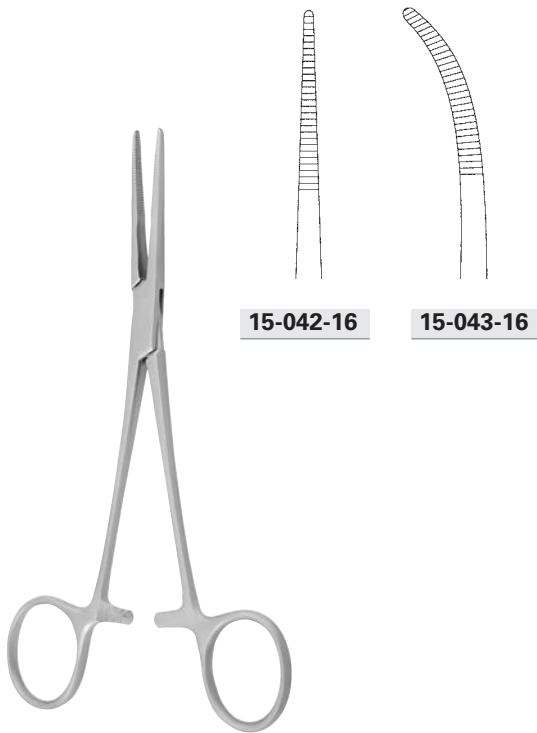

KELLY-RANKIN

15-042-16 - 15-043-16 16,0 cm, 6 ¼ "



DIXON-LOVELACE

15-044-15 15,0 cm, 6 "

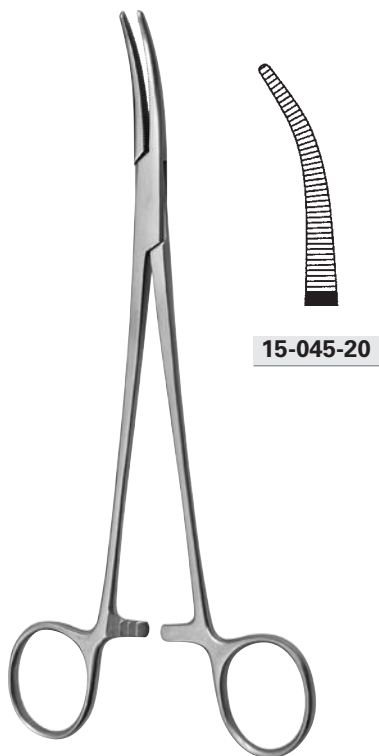

FUCHSIG

15-045-20 20,0 cm, 8 "

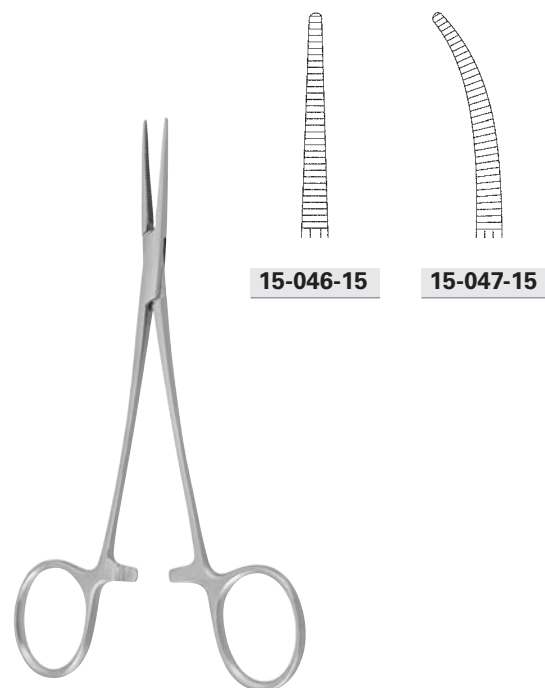

LERICHE

15-046-15 - 15-047-15 15,0 cm, 6 "

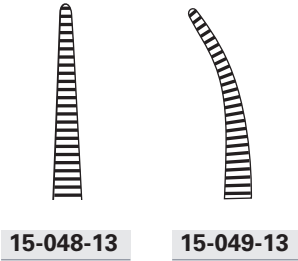

15-048-13

15-049-13

BABY-CRILE

15-048-13 - 15-049-13 14,0 cm, 5 1/2"

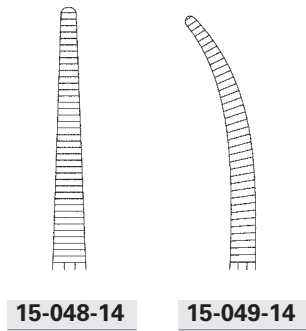

15-048-14

15-049-14

CRILE

15-048-14 - 15-049-14 14,0 cm, 5 1/2"

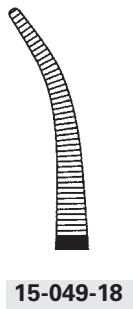

15-049-18

CRILE (FRASER-KELLY)

15-049-18 18,0 cm, 7"



15-050-10

15-050-10 10,0 cm, 4"

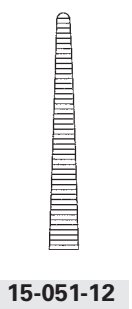

15-051-12

MOSQUITO-DANDY

15-051-12 12,0 cm, 4 3/4"

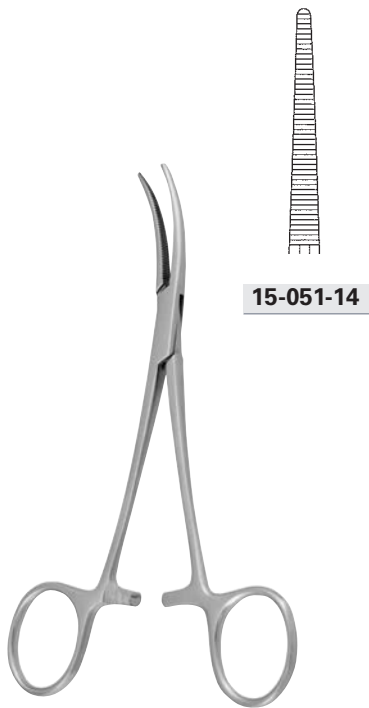

DANDY

15-051-14 14,0 cm, 5 1/2"

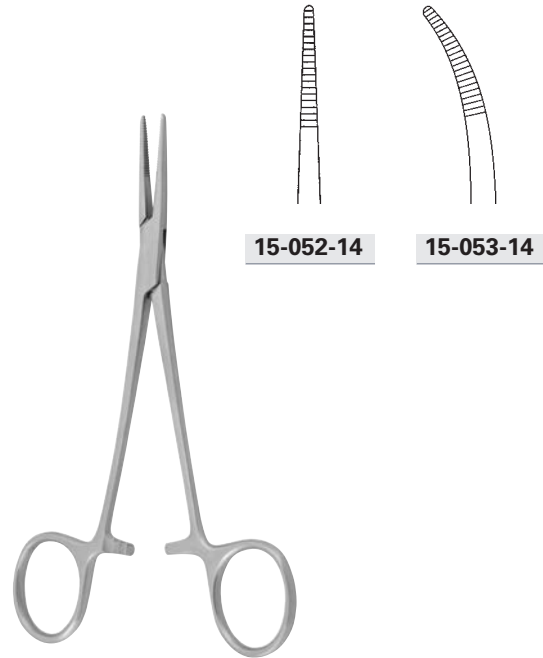

KELLY

15-052-14 - 15-053-14 14,0 cm, 5 1/2"

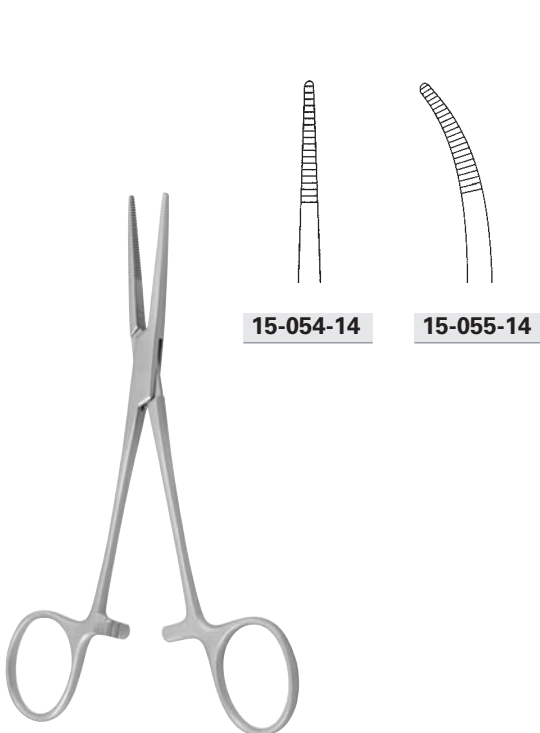

PROVIDENCE-HOSPITAL

15-054-14 - 15-055-14 14,0 cm, 5 1/2"

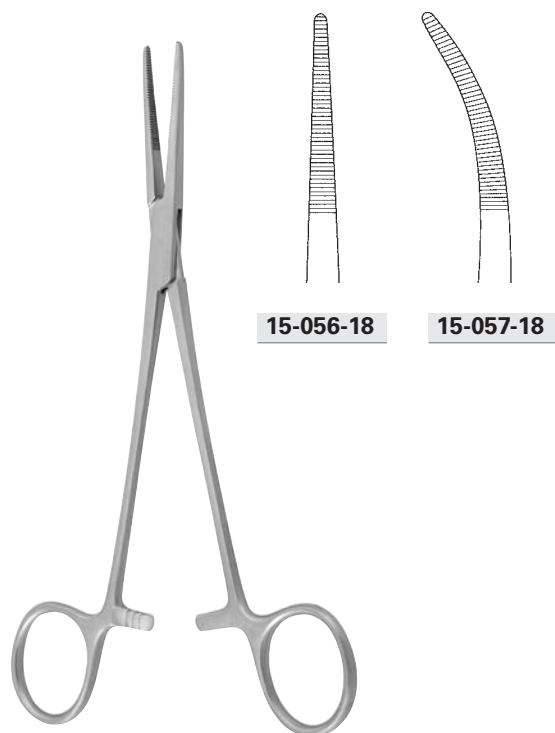

BIRKETT

15-056-18 - 15-057-18 18,5 cm, 7 1/4"



15-060-12



15-060-14



15-061-12



15-061-14

HALSTED-MOSQUITO

15-060-12 - 15-061-12 12,5 cm, 5 "
15-060-14 - 15-061-14 14,0 cm, 5 1/2 "

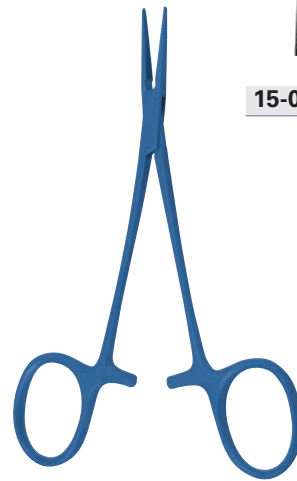

15-060-12 T



15-061-12 T



HALSTED-MOSQUITO

15-060-12 T - 15-061-12 T 12,5 cm, 5 "



15-062-10



15-062-12



15-063-10



15-063-12

MICRO-MOSQUITO

15-062-10 - 15-063-10 10,0 cm, 4 "
15-062-12 - 15-063-12 12,5 cm, 5 "



15-064-10



15-065-10



HARTMANN

15-064-10 - 15-065-10 10,0 cm, 4 "



15-066-08



CARREL

15-066-08 8,0 cm, 3 1/8"



15-067-12



BABY-MOSQUITO

15-067-12 12,0 cm, 4 3/4"



15-068-14



15-069-14



CAIRNS

15-068-14 - 15-069-14 14,0 cm, 5 1/2"



15-072-13



KROENLEIN

15-072-13 13,0 cm, 5 1/8"



15-100-14



15-100-15



15-100-16



15-100-18



15-100-20

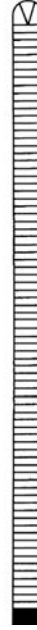

15-100-22

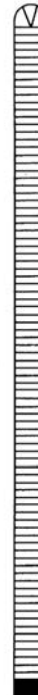

15-100-24



15-100-26

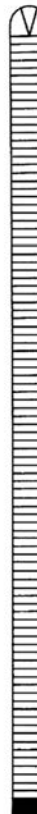

15-100-30



15-100-36

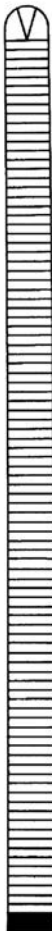

15-100-40



OCHSNER-KOCHER

15-100-14	14,0 cm, 5 1/2 "
15-100-15	15,0 cm, 6 "
15-100-16	16,0 cm, 6 1/4 "
15-100-18	18,0 cm, 7 "
15-100-20	20,0 cm, 8 "
15-100-22	22,0 cm, 8 3/4 "
15-100-24	24,0 cm, 9 1/2 "
15-100-26	26,0 cm, 10 1/4 "
15-100-30	30,0 cm, 11 3/4 "
15-100-36	36,0 cm, 14 1/4 "
15-100-40	40,0 cm, 16 "

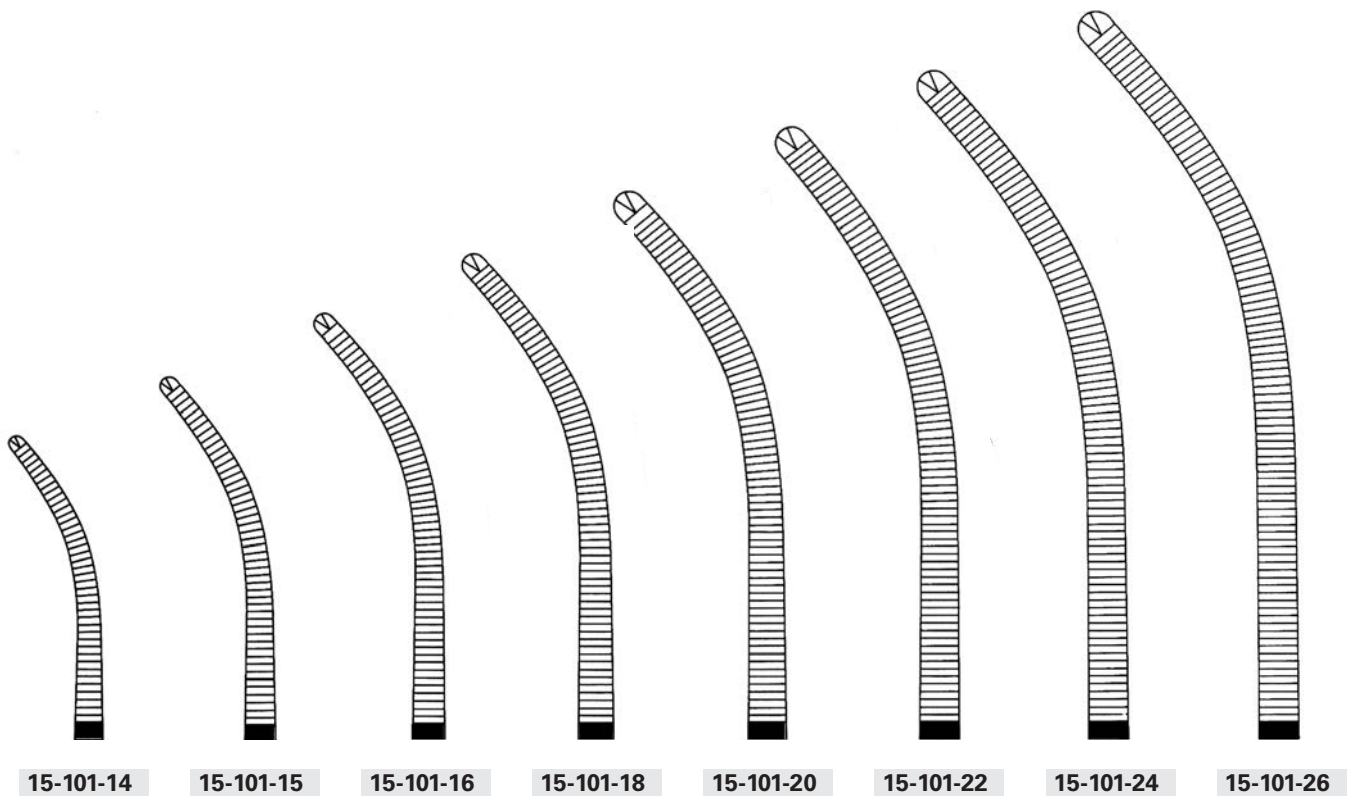

15-101-14

15-101-15

15-101-16

15-101-18

15-101-20

15-101-22

15-101-24

15-101-26

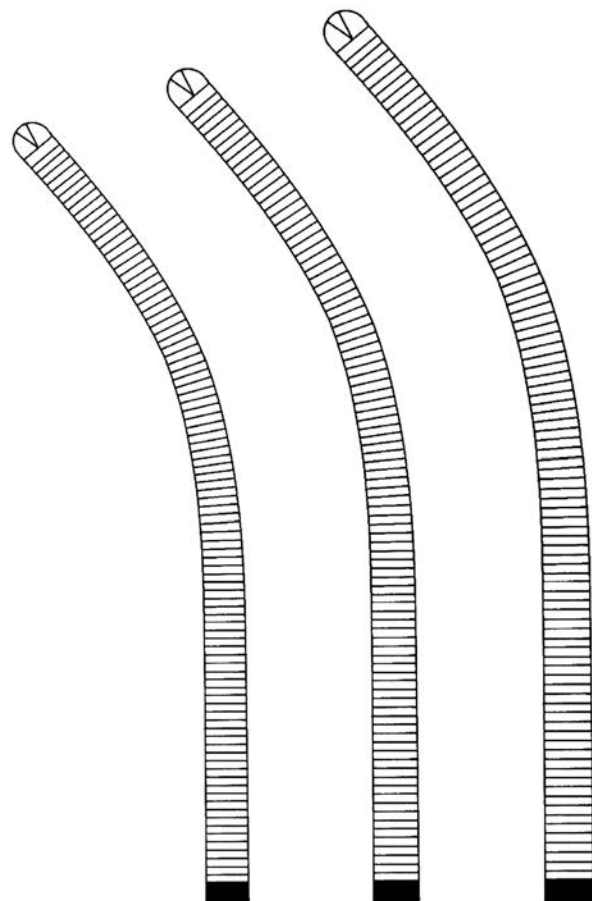

15-101-30

15-101-36

15-101-40



OCHSNER-KOCHER

15-101-14	14,0 cm, 5 1/2"
15-101-15	15,0 cm, 6"
15-101-16	16,0 cm, 6 1/4"
15-101-18	18,0 cm, 7"
15-101-20	20,0 cm, 8"
15-101-22	22,0 cm, 8 3/4"
15-101-24	24,0 cm, 9 1/2"
15-101-26	26,0 cm, 10 1/4"
15-101-30	30,0 cm, 11 3/4"
15-101-36	36,0 cm, 14 1/4"
15-101-40	40,0 cm, 16"



15-110-13



15-110-14



15-110-16

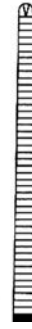

15-110-18

fein
delicate
fino
fine

KOCHER

15-110-13	13,0 cm, 5 1/8"
15-110-14	14,0 cm, 5 1/2"
15-110-16	16,0 cm, 6 1/4"
15-110-18	18,0 cm, 7"



15-111-13



15-111-14

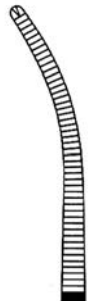

15-111-16



15-111-18

fein
delicate
fino
fine

KOCHER

15-111-13	13,0 cm, 5 1/8"
15-111-14	14,0 cm, 5 1/2"
15-111-16	16,0 cm, 6 1/4"
15-111-18	18,0 cm, 7"

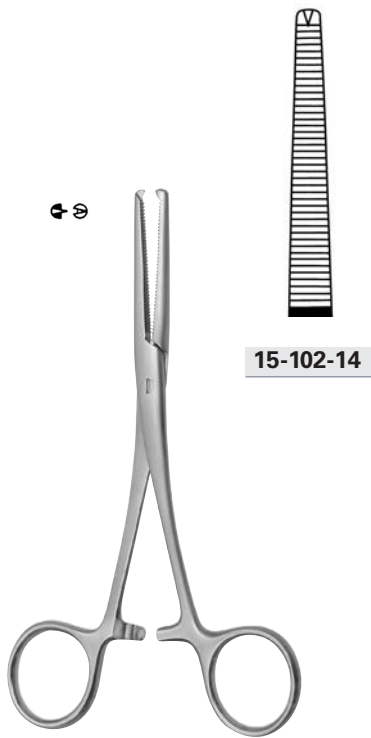

15-102-14

KOCHER

15-102-14 14,0 cm, 5 1/2"

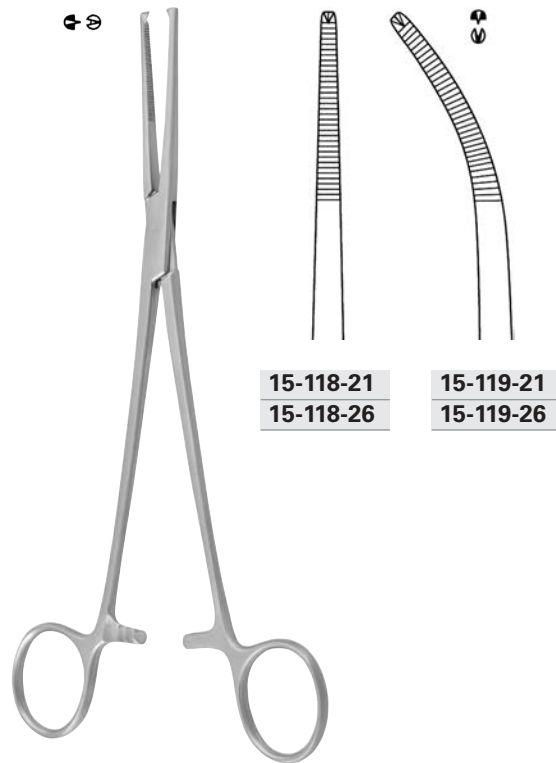

15-118-21
15-118-26

15-119-21
15-119-26

TOENNIS

15-118-21 - 15-119-21 21,0 cm, 8 1/4"
15-118-26 - 15-119-26 26,0 cm, 10 1/4"

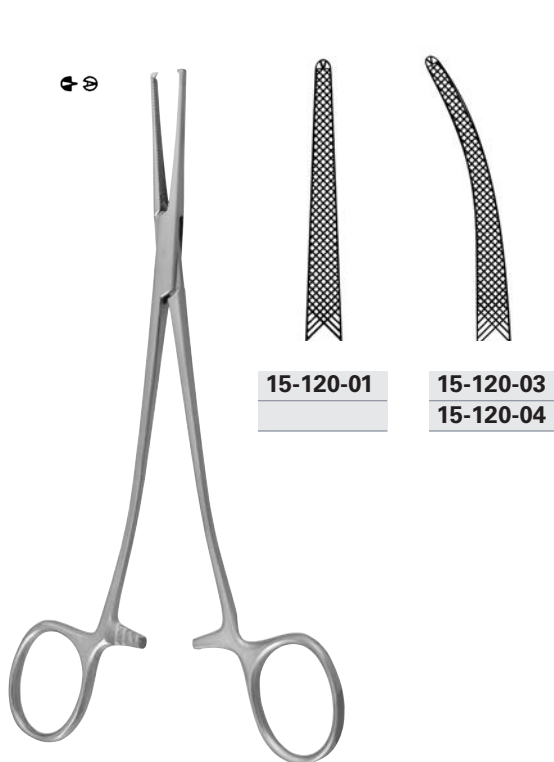

15-120-01

15-120-03
15-120-04

BENGOLEA (MOD. FRENCH)

15-120-01 - 15-120-03 18,0 cm, 7"
15-120-04 23,0 cm, 9"

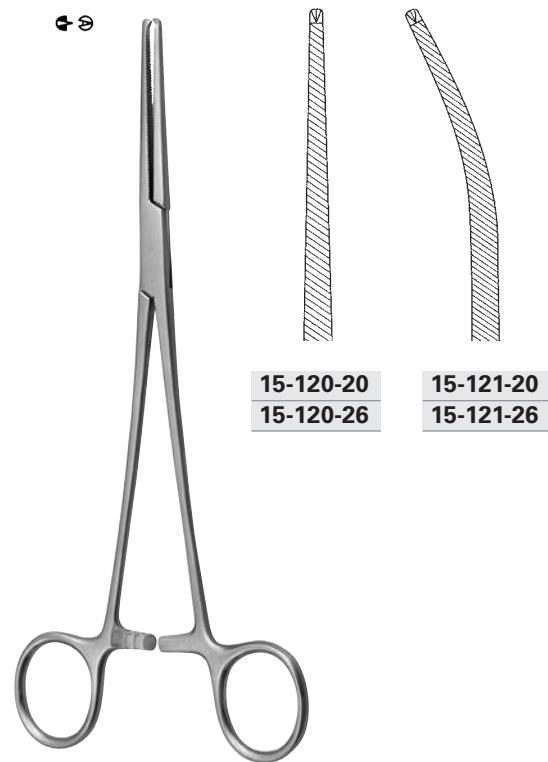

15-120-20
15-120-26

15-121-20
15-121-26

BENGOLEA

15-120-20 - 15-121-20 20,0 cm, 8"
15-120-26 - 15-121-26 26,0 cm, 10 1/4"

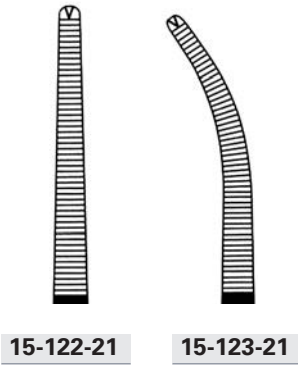

15-122-21

15-123-21

HEISS

15-122-21 - 15-123-21 21,0 cm, 8 ¼"

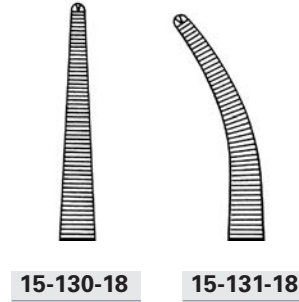

15-130-18

15-131-18

ADSON

15-130-18 - 15-131-18 18,0 cm, 7"

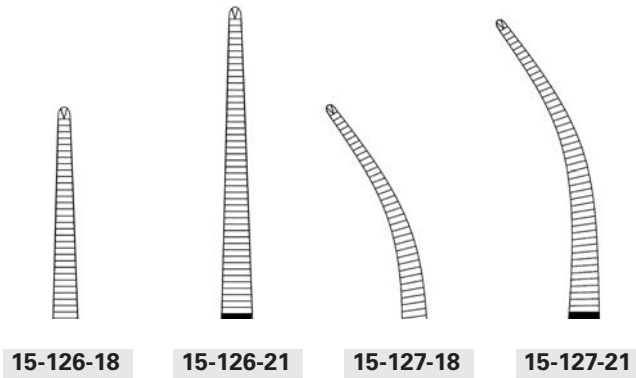
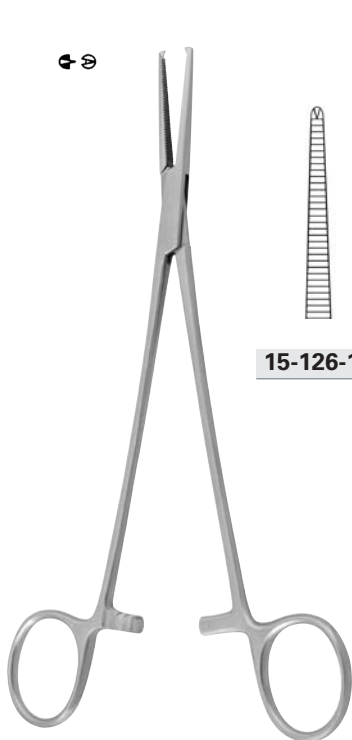

15-126-18

15-126-21

15-127-18

15-127-21

HALSTED-MOSQUITO

15-126-18 - 15-127-18 18,0 cm, 7"
15-126-21 - 15-127-21 21,0 cm, 8 ¼"

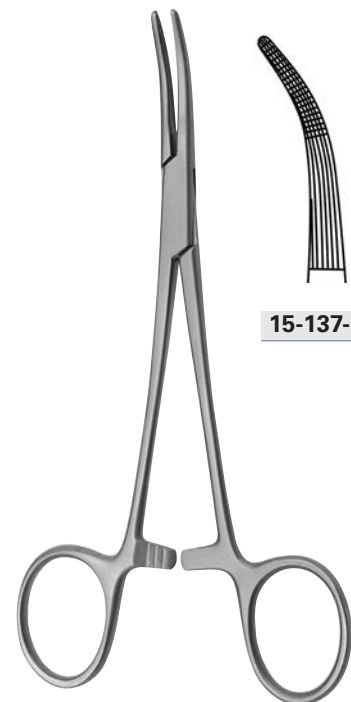

15-137-18

GREY-TURNER

15-137-18 18,0 cm, 7"

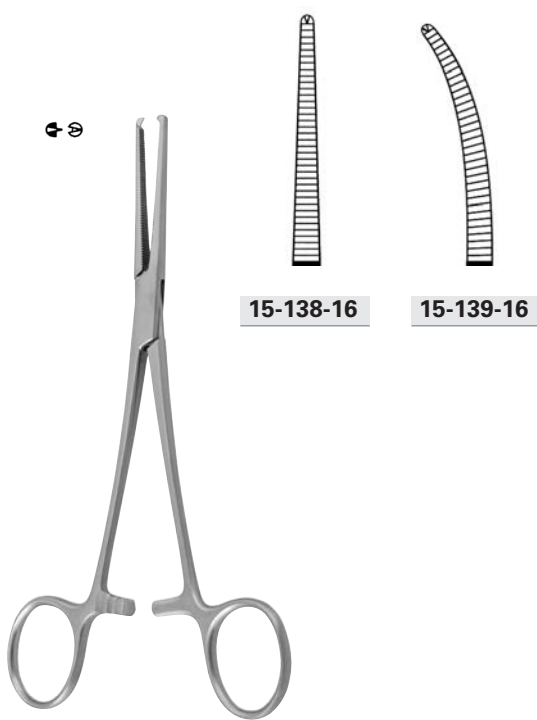

CRILE-RANKIN

15-138-16 - 15-139-16 16,0 cm, 6 ¼ "

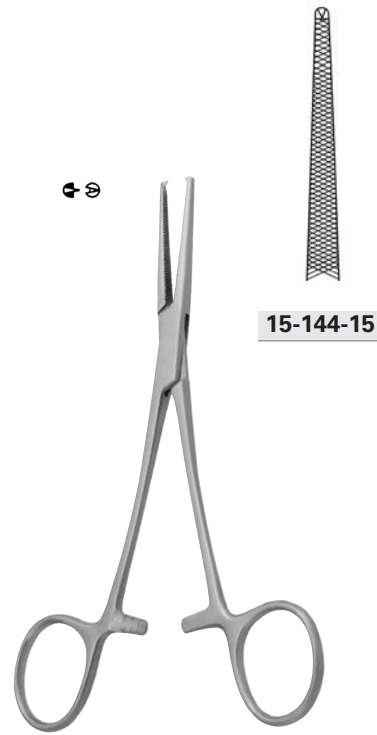

DIXON-LOVELACE

15-144-15 15,0 cm, 6 "

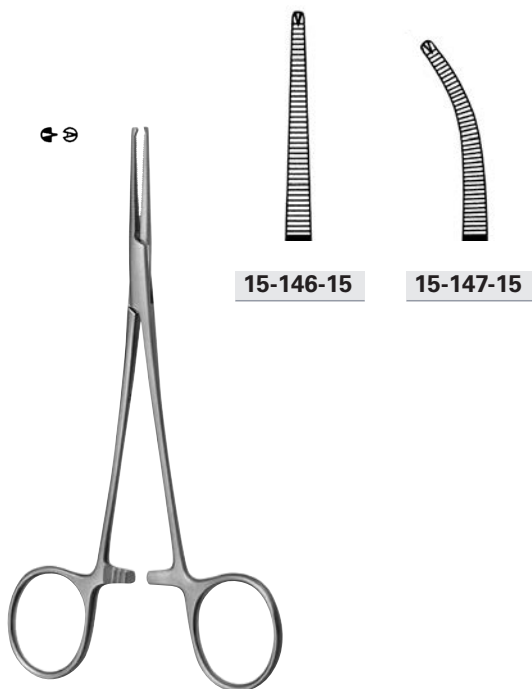

LERICHE

15-146-15 - 15-147-15 15,0 cm, 6 "

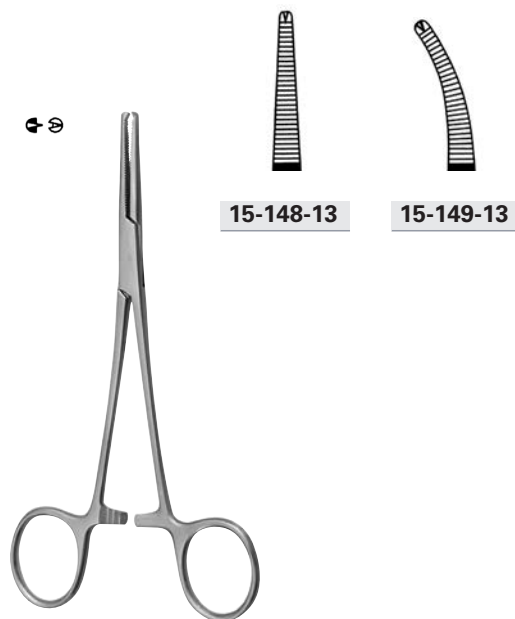

BABY-CRILE

15-148-13 - 15-149-13 14,0 cm, 5 ½ "

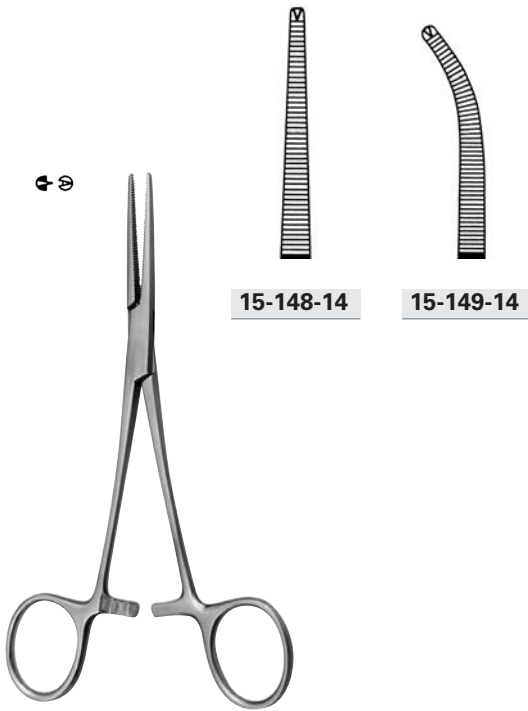

CRILE

15-148-14 - 15-149-14 14,0 cm, 5 ½"

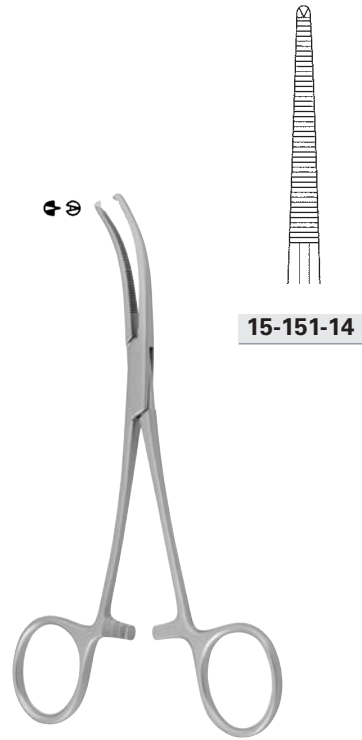

DANDY

15-151-14 14,0 cm, 5 ½"

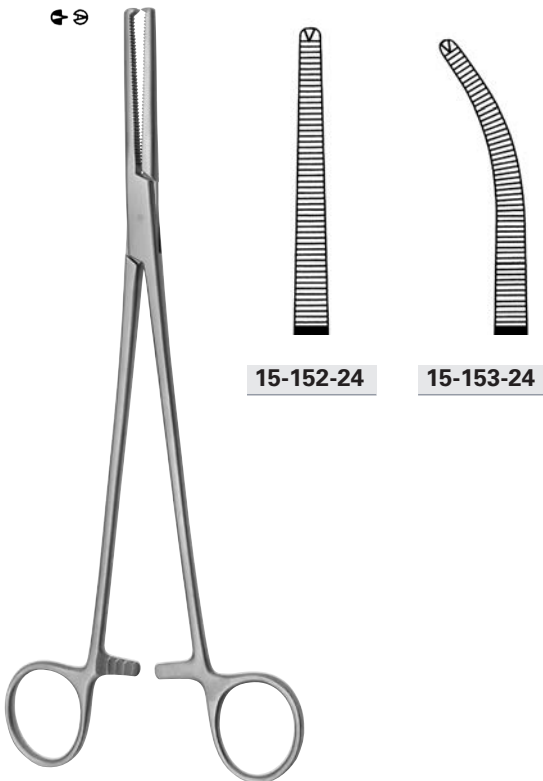

HOLZBACH

15-152-24 - 15-153-24 24,0 cm, 9 ½"



HALSTED-MOSQUITO

15-160-12 - 15-161-12 12,5 cm, 5"
15-160-14 - 15-161-14 14,0 cm, 5 ½"

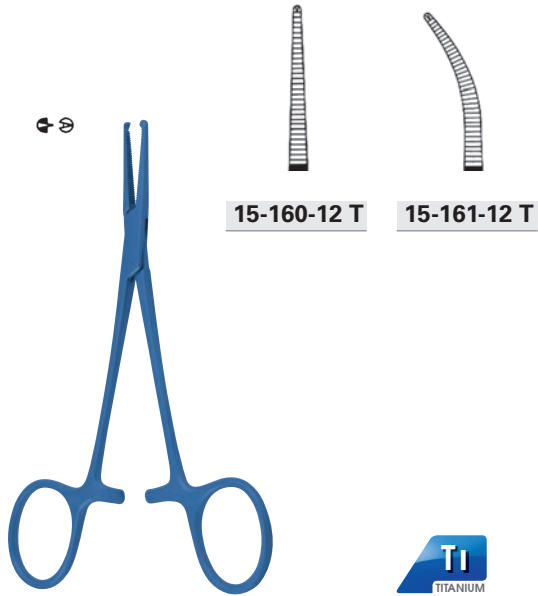

HALSTED-MOSQUITO

15-160-12 T - 15-161-12 T 12,5 cm, 5 "

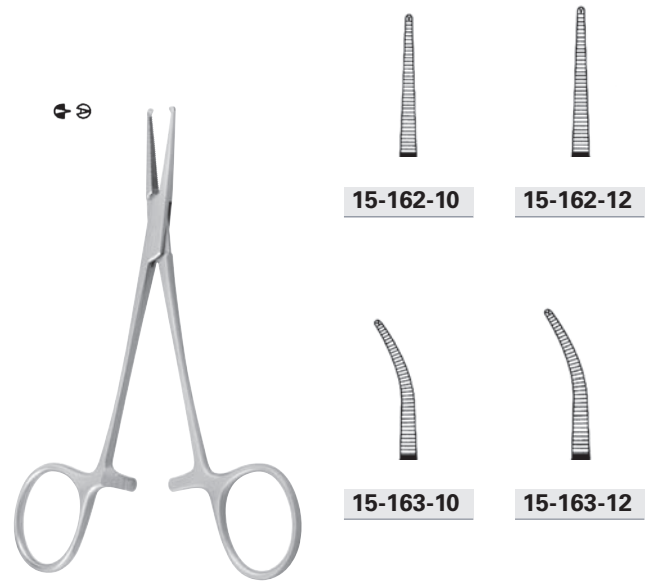

MICRO-MOSQUITO

15-162-10 - 15-163-10 10,0 cm, 4 "
 15-162-12 - 15-163-12 12,5 cm, 5 "

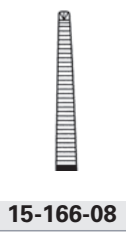

TERRIER

15-166-08 8,0 cm, 3 1/8 "

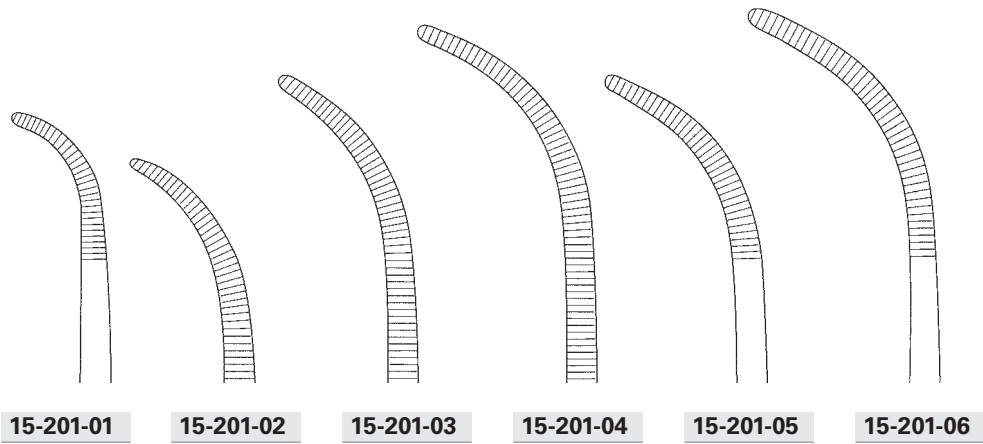

OVERHOLT-GEISSENDOERFER

15-201-01 - 15-201-07 21,0 cm, 8 1/4"

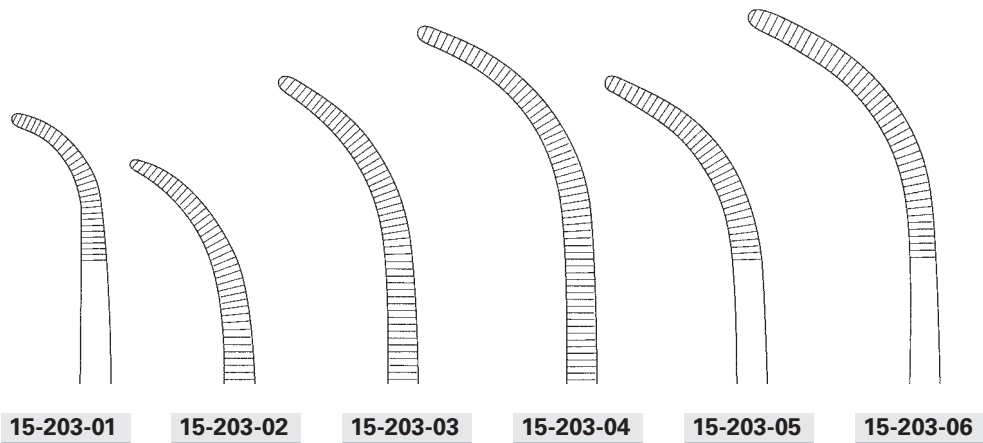
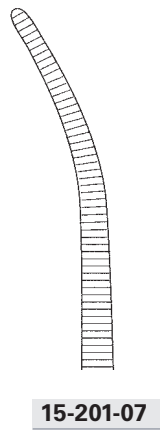

OVERHOLT-GEISSENDOERFER

15-203-01 - 15-203-07 27,0 cm, 10 3/4"

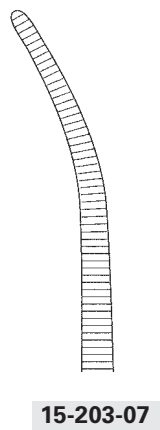

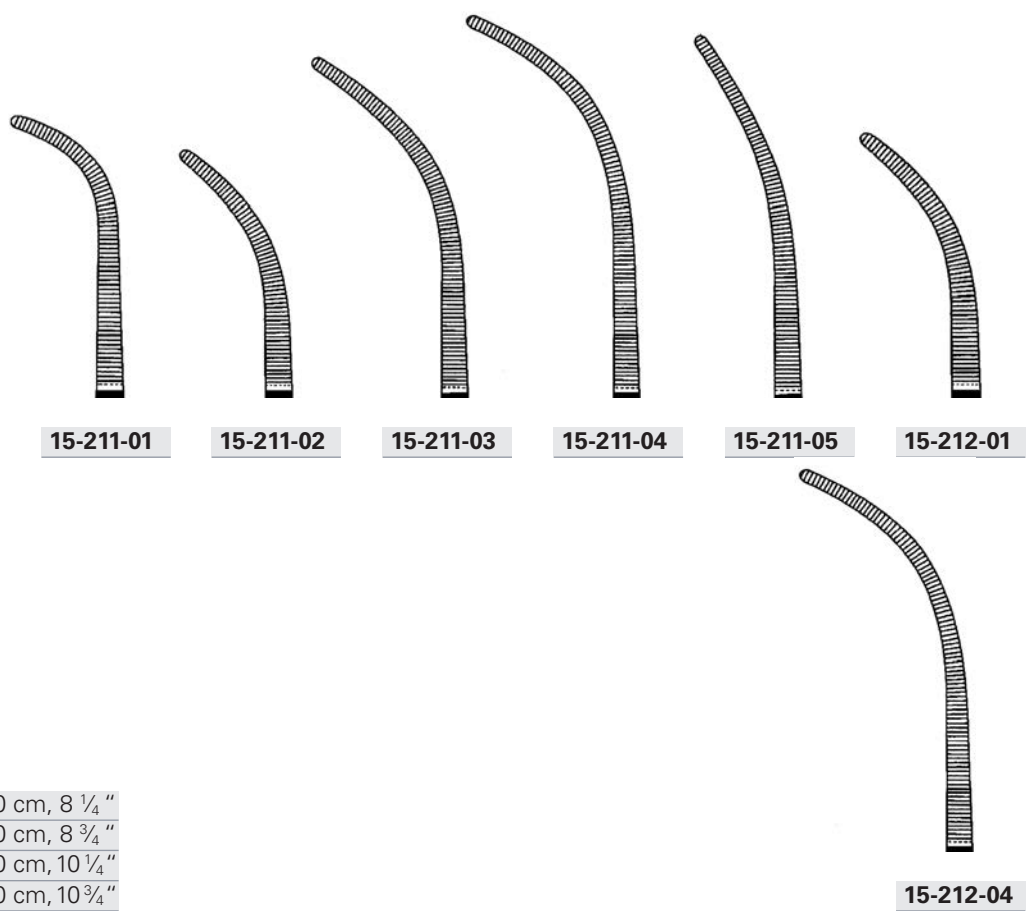

OVERHOLT

15-211-01 - 15-211-02	21,0 cm, 8 1/4"
15-211-03 - 15-211-05	22,0 cm, 8 3/4"
15-212-01	26,0 cm, 10 1/4"
15-212-04	27,0 cm, 10 3/4"

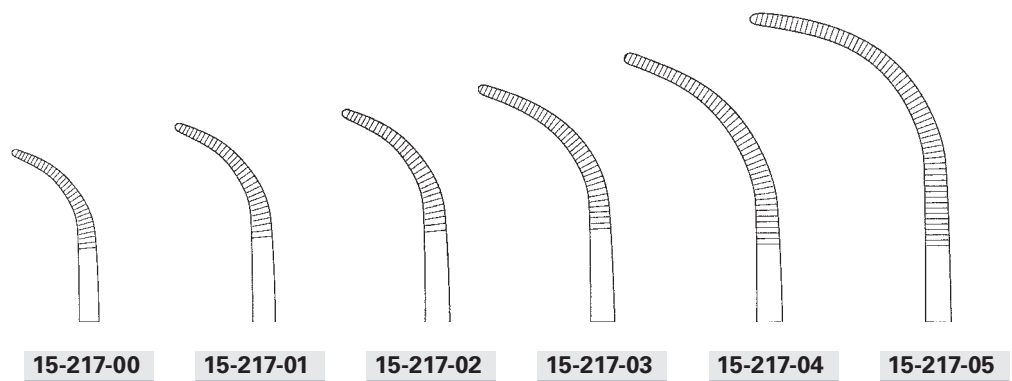
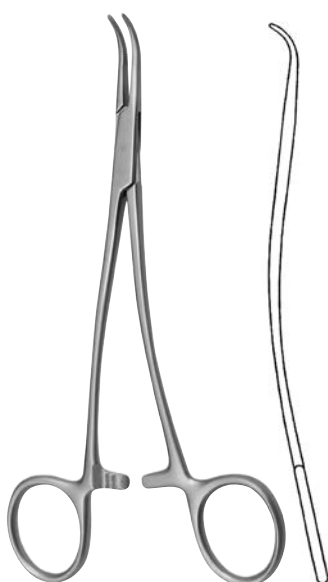

OVERHOLT-S

15-217-00	15,0 cm, 6"
15-217-01	18,5 cm, 7 1/4"
15-217-02	20,5 cm, 8"
15-217-03	21,0 cm, 8 1/4"
15-217-04	21,5 cm, 8 1/2"
15-217-05	24,0 cm, 9 1/2"

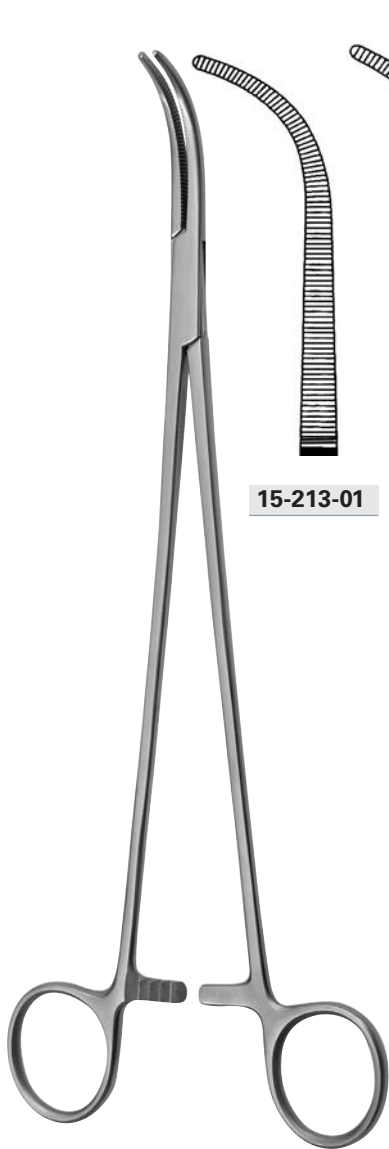

15-213-01

15-213-02

15-213-03

OVERHOLT

15-213-01 - 15-231-02 29,0 cm, 11 1/4"
15-213-03 30,0 cm, 11 3/4"

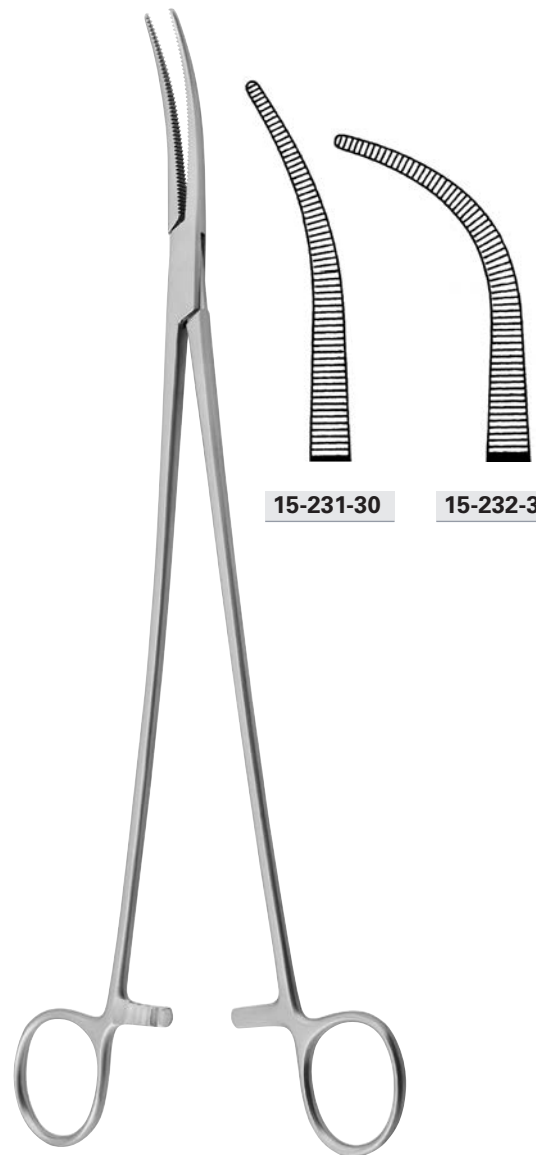

15-231-30

15-232-30

ZENKER

15-231-30 - 15-232-30 30,0 cm, 11 3/4"



ZENKER

15-231-35 - 15-232-36 35,0 cm, 13 3/4"



15-233-28

LAWRENCE

15-233-28 28,0 cm, 11 "



15-234-28



15-235-28

BRIDGE

15-234-28 - 15-235-28 28,0 cm, 11 "

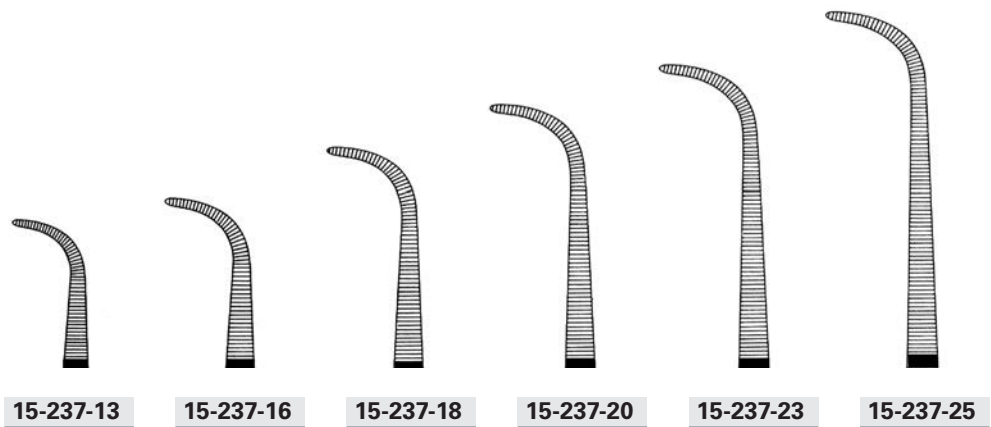

GEMINI

15-237-13	13,0 cm, 5 1/8"
15-237-16	16,0 cm, 6 1/4"
15-237-18	18,0 cm, 7"
15-237-20	20,0 cm, 8"
15-237-23	23,0 cm, 9"
15-237-25	25,0 cm, 9 3/4"
15-237-28	28,0 cm, 11"

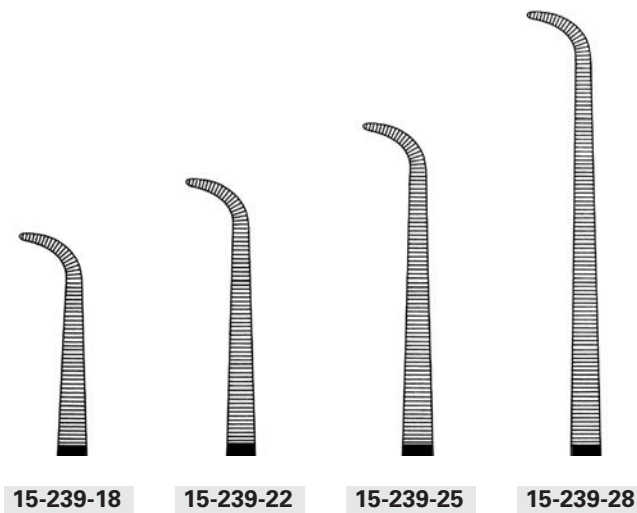
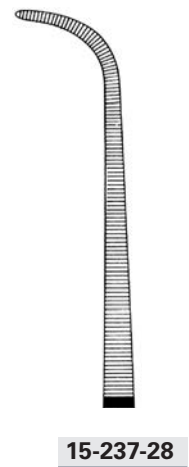

GEMINI

15-239-18	18,0 cm, 7"
15-239-22	22,0 cm, 8 3/4"
15-239-25	25,0 cm, 9 3/4"
15-239-28	28,0 cm, 11"

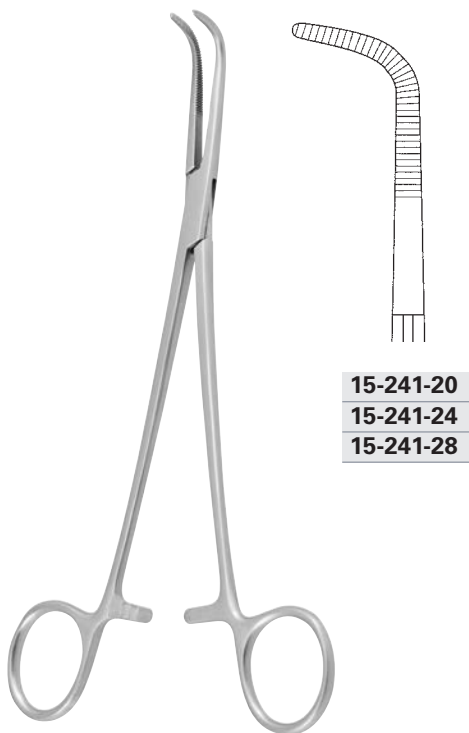

15-241-20
15-241-24
15-241-28

KANTROWITZ

15-241-20	20,0 cm, 8"
15-241-24	24,0 cm, 9 1/2"
15-241-28	28,0 cm, 11"



15-243-18 15-243-28

MEEKER

15-243-18	18,0 cm, 7"
15-243-28	28,0 cm, 11"

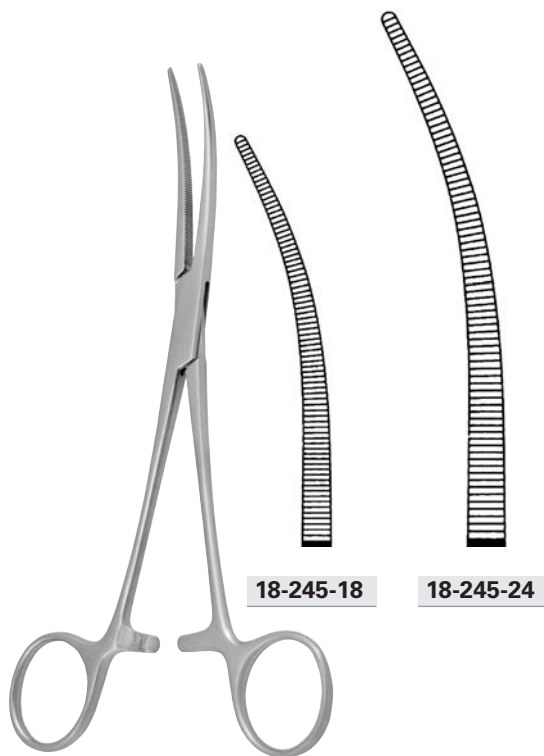

18-245-18 18-245-24

CRAFOORD

15-245-18	18,0 cm, 7"
15-245-24	24,0 cm, 9 1/2"

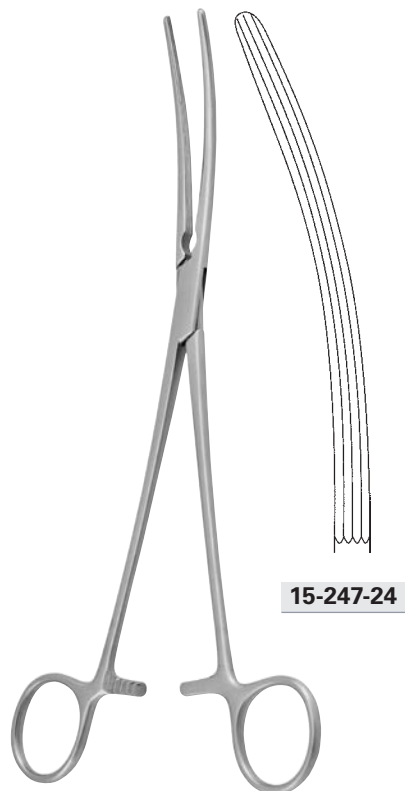

15-247-24

CRAFOORD-SELLORS

15-247-24	24,0 cm, 9 1/2"
-----------	-----------------

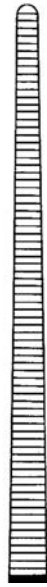

15-248-24

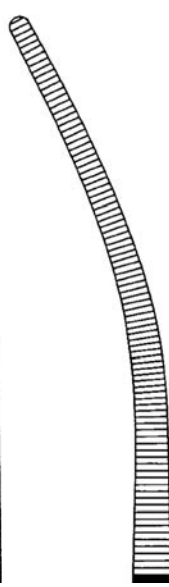

15-249-24

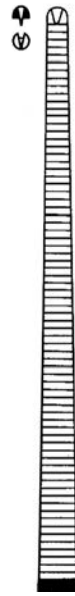

15-250-24

SAROT

15-248-24 - 15-250-24 24,0 cm, 9 1/2"

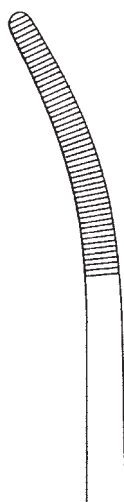

15-251-01

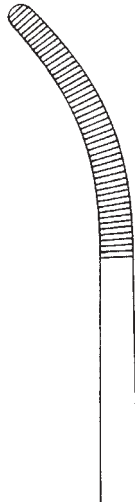

15-251-02

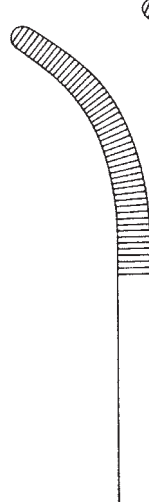

15-251-03

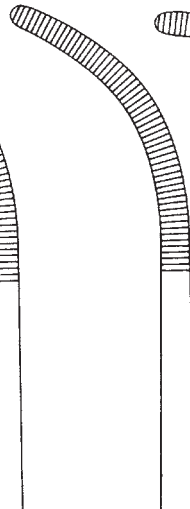

15-251-04

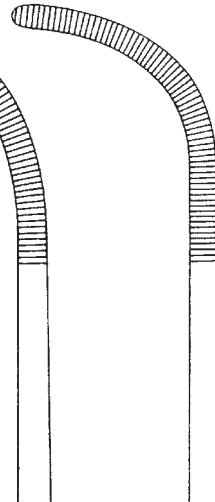

15-251-05

RUMEL

15-251-01 - 15-251-05 23,0 cm, 9"

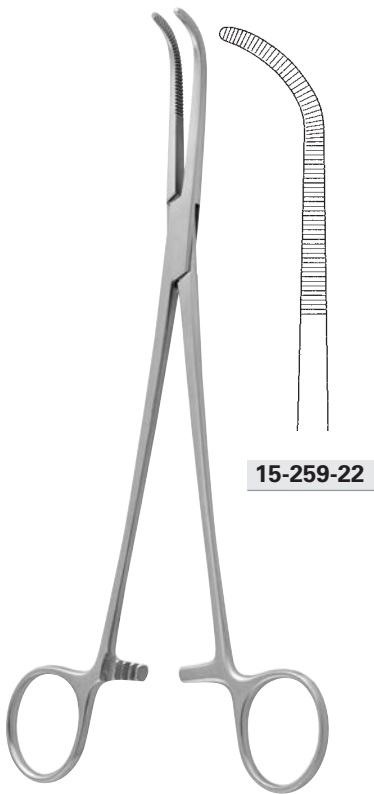

15-259-22

MIXTER

15-259-22 22,0 cm, 8 3/4"

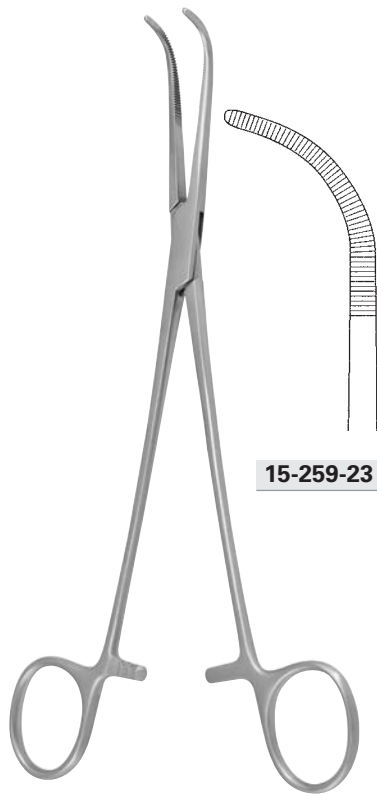

15-259-23

MIXTER

15-259-23 23,0 cm, 9"

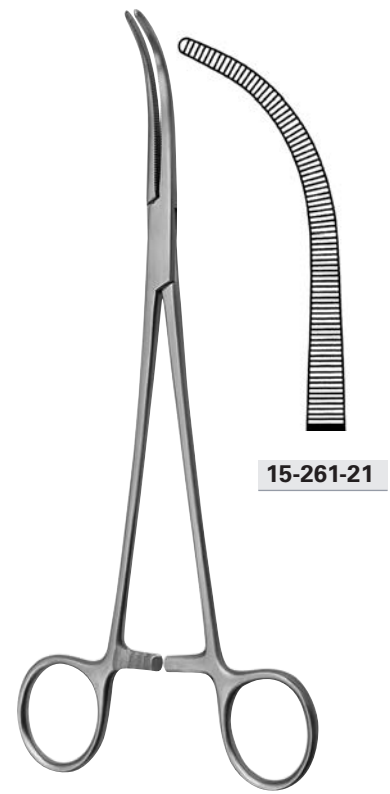

15-261-21

OVERHOLT-MIXTER

15-261-21 21,0 cm, 8 1/4"

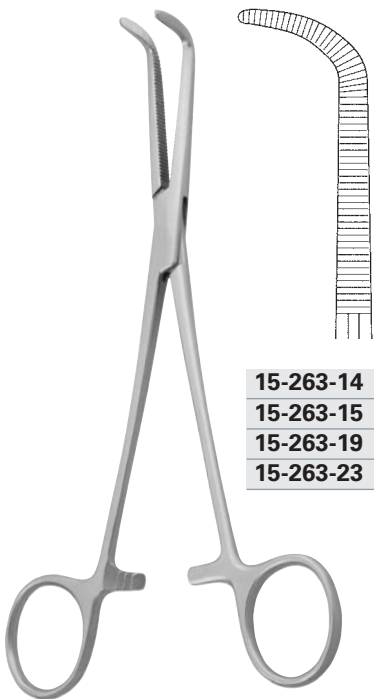

15-263-14
15-263-15
15-263-19
15-263-23

MIXTER

15-263-14 14,0 cm, 5 1/2"
15-263-15 15,0 cm, 6"
15-263-19 19,0 cm, 7 1/2"
15-263-23 23,0 cm, 9"

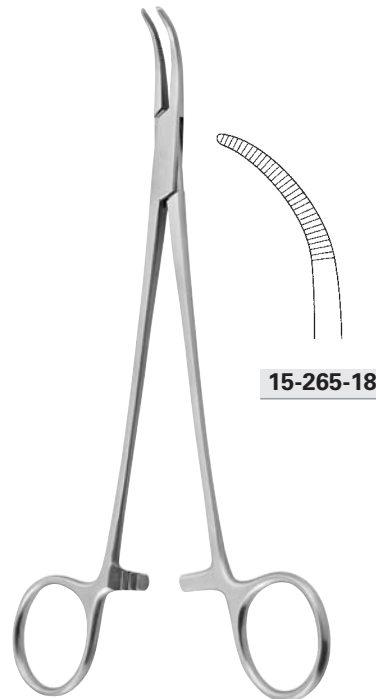

15-265-18

MIXTER

15-265-18 18,0 cm, 7"

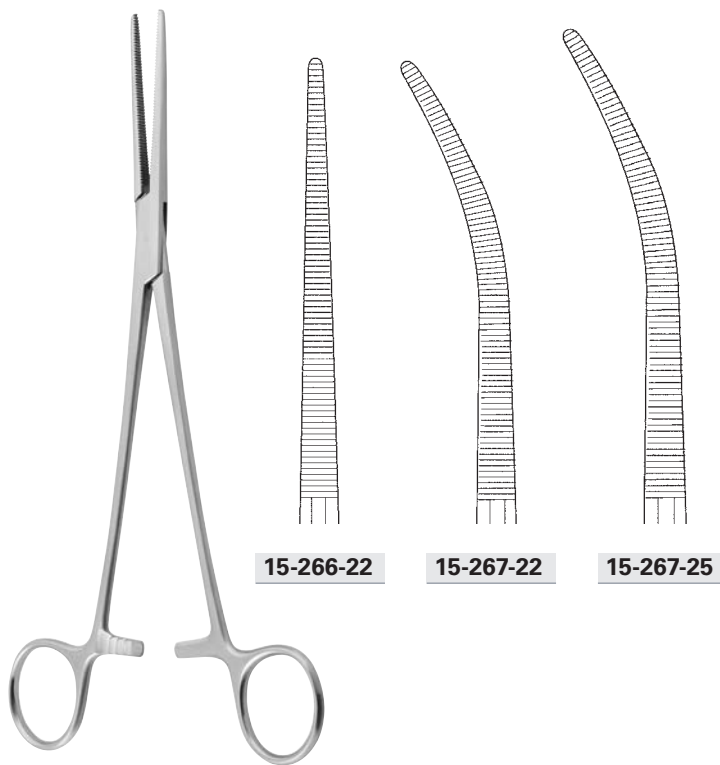

15-266-22

15-267-22

15-267-25

ROBERTS

15-266-22 - 15-267-22 22,0 cm, 8 3/4 "
 15-267-25 25,0 cm, 9 3/4 "

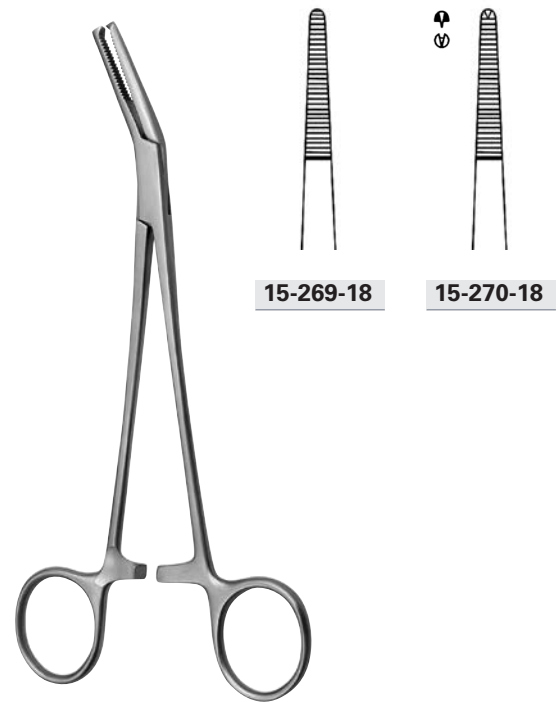

15-269-18

15-270-18

FICKLING

15-269-18 - 15-270-18 18,0 cm, 7 "

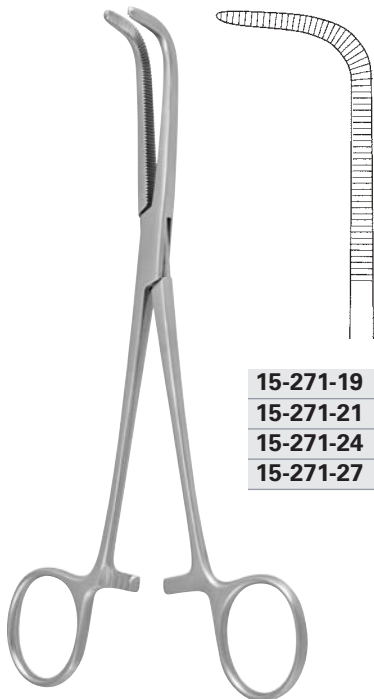

15-271-19

15-271-21

15-271-24

15-271-27

WIKSTROEM

15-271-19 19,0 cm, 7 1/2 "
 15-271-21 21,0 cm, 8 1/4 "
 15-271-24 24,0 cm, 9 1/2 "
 15-271-27 27,0 cm, 10 3/4 "



15-273-14

15-273-18

BABY-ADSON

15-273-14 14,0 cm, 5 1/2 "
 15-273-18 18,0 cm, 7 "



BABY-MIXTER

15-275-01 - 15-275-02 14,0 cm, 5 1/2"

BABY-OVERHOLT

15-279-13 13,0 cm, 5 1/8"

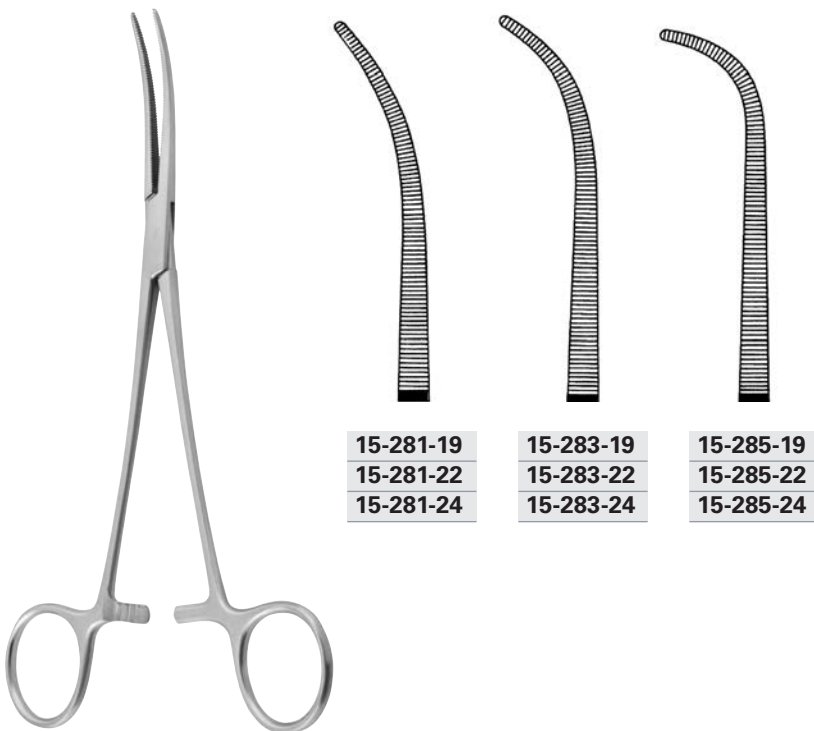

KELLY

15-281-19 - 15-285-19 19,0 cm, 7 1/2"
15-281-22 - 15-285-22 22,0 cm, 8 3/4"
15-281-24 - 15-285-24 24,0 cm, 9 1/2"

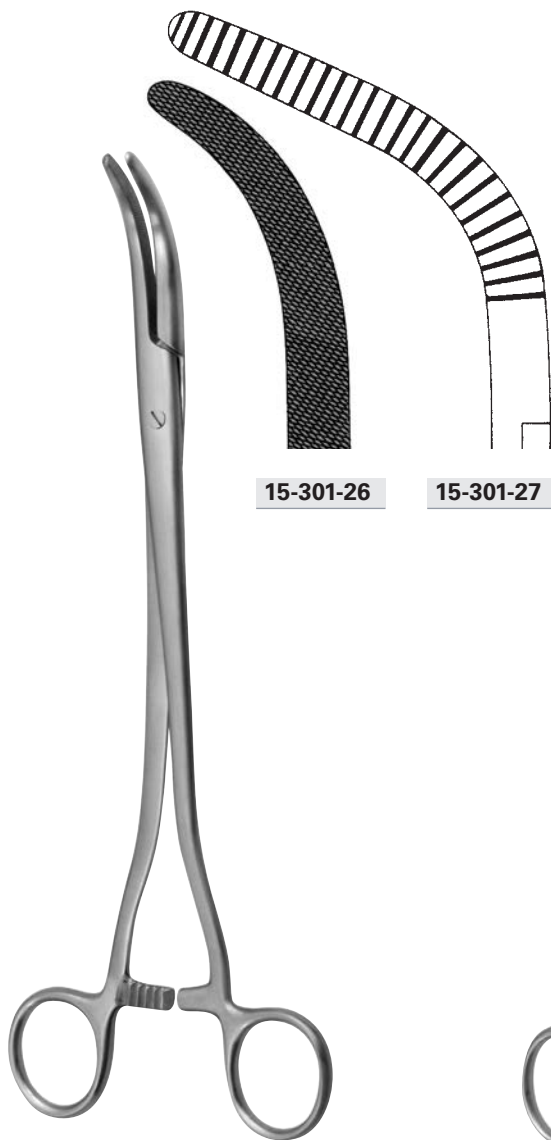

15-301-26

15-301-27

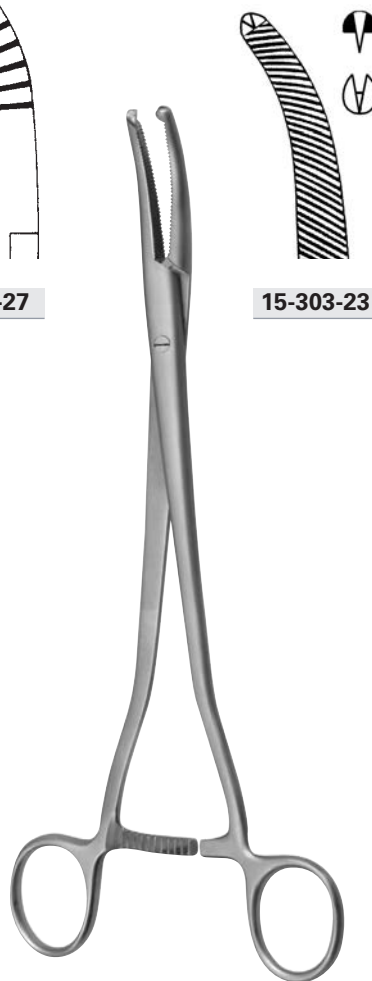

15-303-23



15-303-24

WERTHEIM

15-301-26 26,0 cm, 10 1/4"
15-301-27 27,0 cm, 10 3/4"

WERTHEIM

15-303-23 23,5 cm, 9 1/4"

WERTHEIM

15-303-24 23,5 cm, 9 1/4"

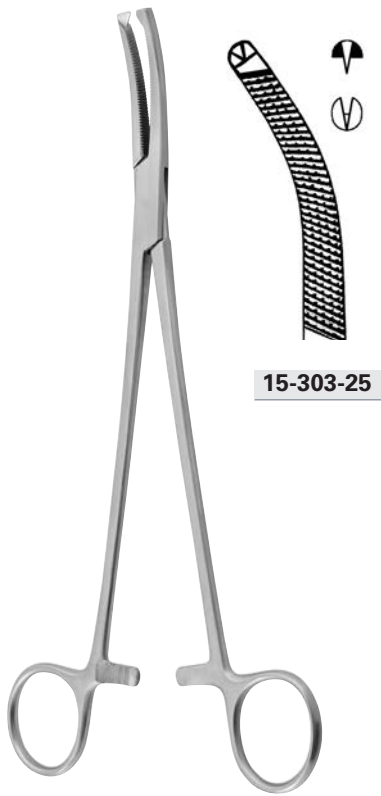

15-303-25

WERTHEIM

15-303-25 24,5 cm, 9 5/8"

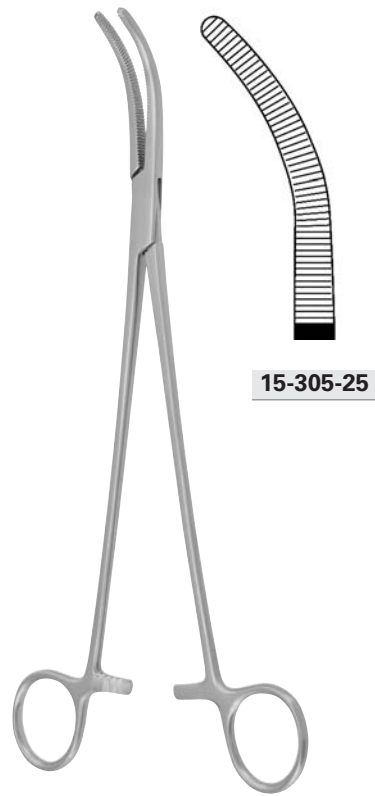

15-305-25

WERTHEIM

15-305-25 25,0 cm, 9 3/4"

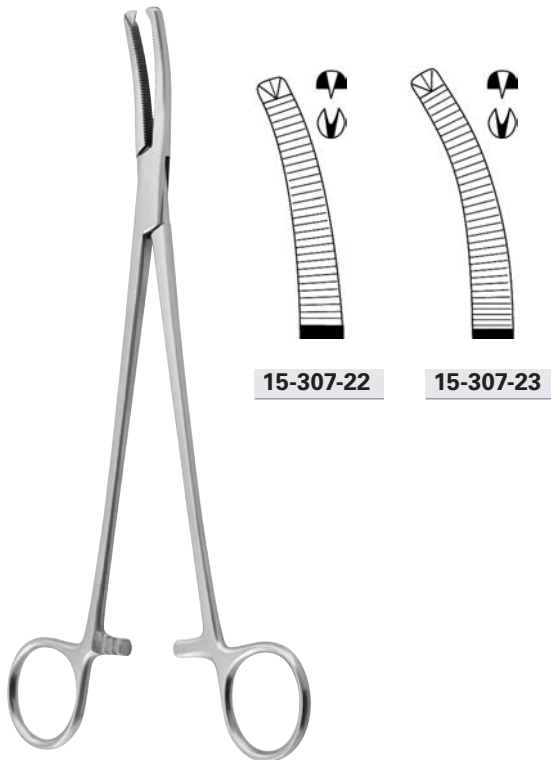

15-307-22

15-307-23

WERTHEIM

15-307-22 22,0 cm, 8 3/4"

15-307-23 23,0 cm, 9"

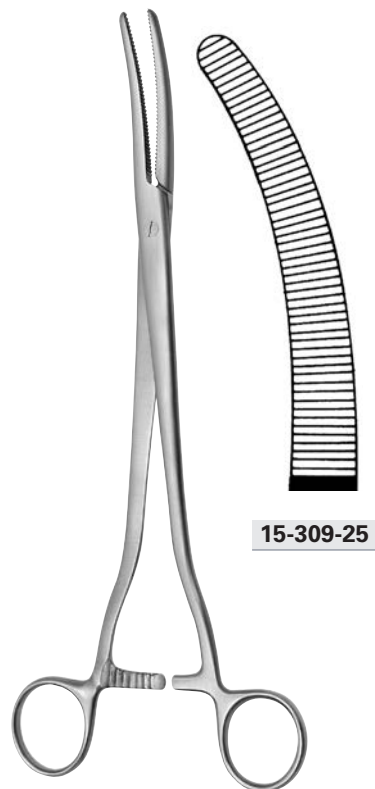

15-309-25

FAURE

15-309-25 25,0 cm, 9 3/4"

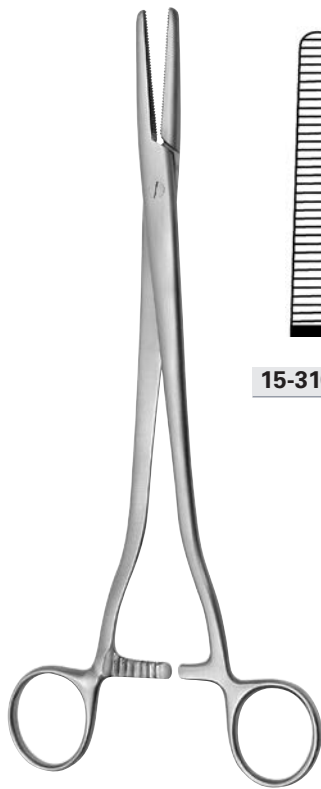

15-310-24



15-311-24

SEGOND-LANDAUF

15-310-24 - 15-311-24 24,0 cm, 9 1/2"



15-313-14

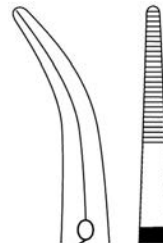

MOYNIHAN

15-313-14 14,5 cm, 5 3/4"



15-313-15

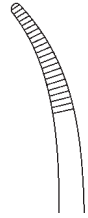

MOYNIHAN

15-313-15 15,0 cm, 6"

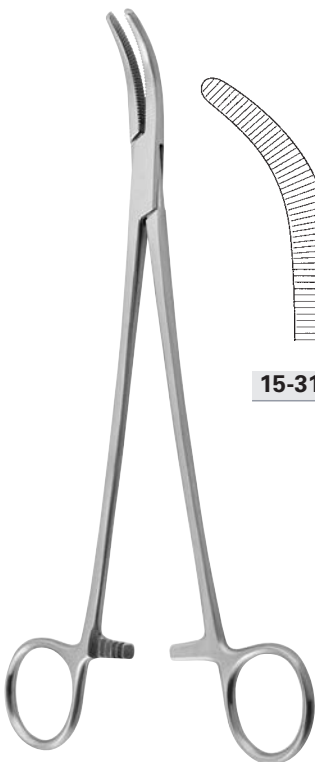

15-313-23

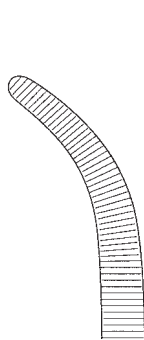

15-313-24

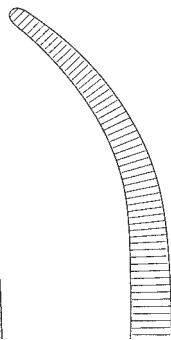

MOYNIHAN

15-313-23 23,0 cm, 9"
 15-313-24 24,0 cm, 9 1/2"



15-314-21

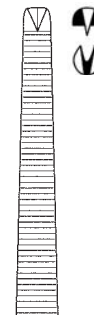

15-315-21

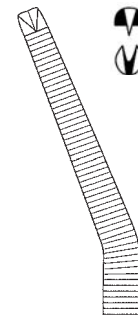

PHANEUF

15-314-21 - 15-315-21 21,0 cm, 8 1/4"

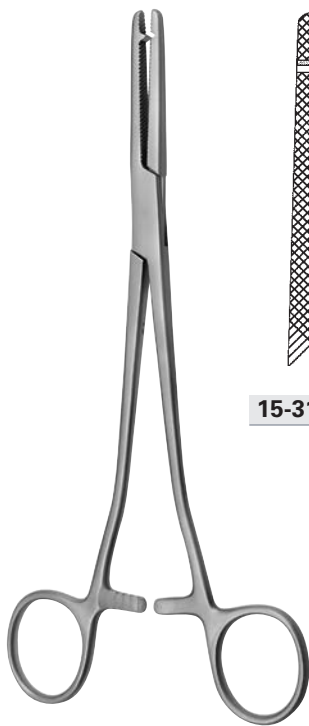

15-316-21



15-317-20



15-317-21



15-317-23

HEANEY-RAZAK

15-316-21 21,0 cm, 8 ¼"

HEANEY

15-317-20	20,0 cm, 8"
15-317-21	21,0 cm, 8 ¼"
15-317-23	23,0 cm, 9"



15-319-20



15-319-21



15-319-23



15-321-22

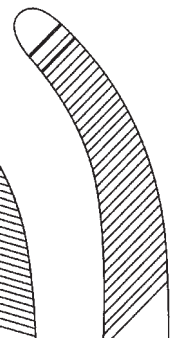
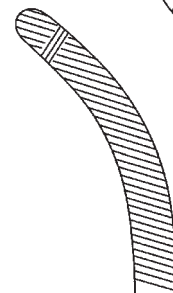

15-321-24

HEANEY

15-319-20	20,0 cm, 8"
15-319-21	21,0 cm, 8 ¼"
15-319-23	23,0 cm, 9"

WIENER MOD.

15-321-22	22,0 cm, 8 ¾"
15-321-24	24,0 cm, 9 ½"

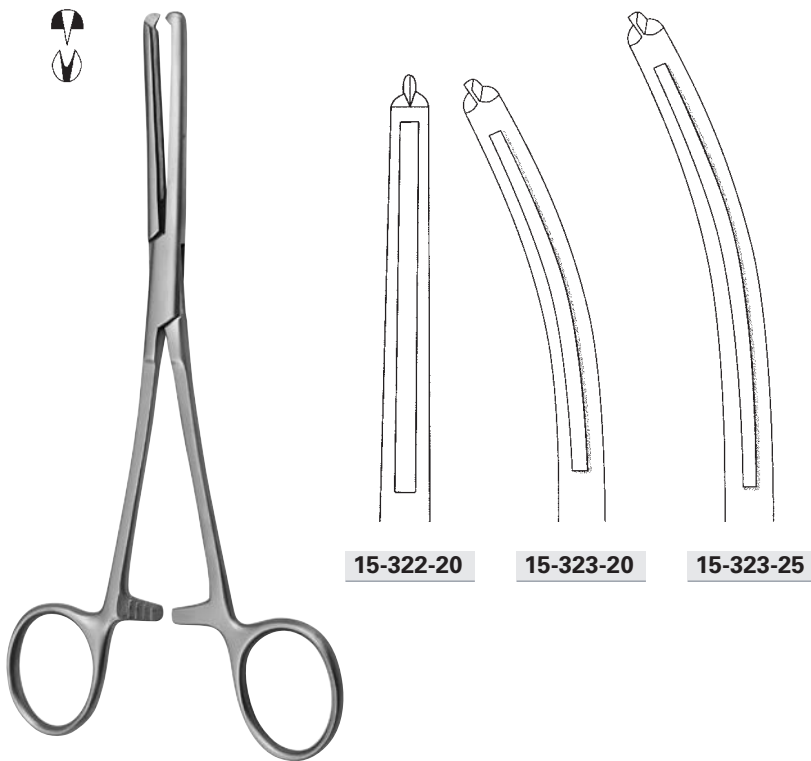

15-322-20

15-323-20

15-323-25

MAINGOTT

15-322-20 - 15-323-20	20,0 cm, 8 "
15-323-25	25,0 cm, 9 3/4 "

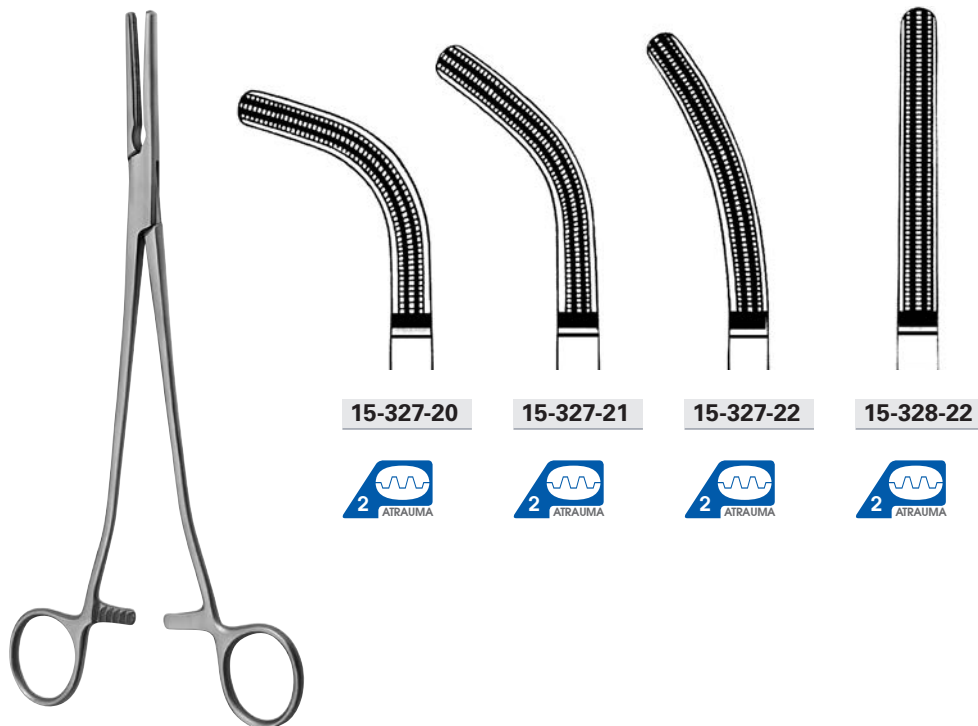

15-327-20

15-327-21

15-327-22

15-328-22



ROGERS

15-327-20	20,0 cm, 8 "
15-327-21	21,0 cm, 8 1/4 "
15-327-22 - 15-328-22	22,0 cm, 8 3/4 "

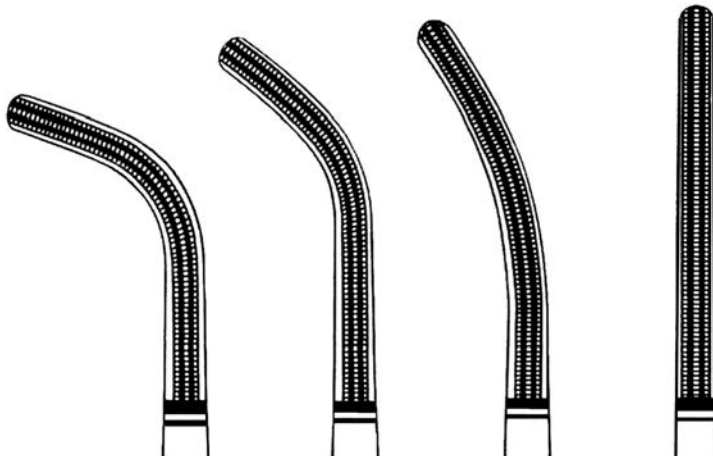

15-329-23

15-329-24

15-329-25

15-330-25



ROGERS

15-329-23	23,0 cm, 9"
15-329-24	24,0 cm, 9 1/2"
15-329-25 - 15-330-25	25,0 cm, 9 3/4"

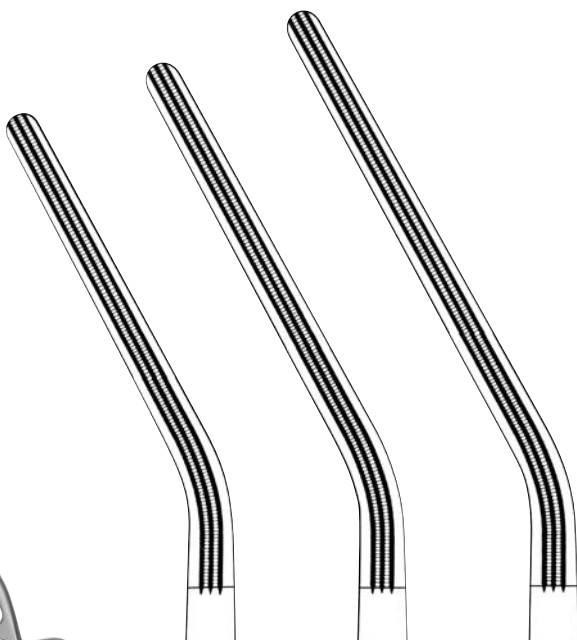

15-331-25

15-331-26

15-331-27



DICK

15-331-25	25,0 cm, 9 3/4"
15-331-26	26,0 cm, 10 1/4"
15-331-27	27,0 cm, 10 3/4"



15-335-21

WERTHEIM-CULLEN

15-335-21	21,0 cm, 8 1/4"
-----------	-----------------



15-338-15

PRATT

15-338-15 15,0 cm, 6"



15-339-18

MIKULICZ

15-339-18 18,5 cm, 7 1/4"



15-339-20

MIKULICZ

15-339-20 20,5 cm, 8"

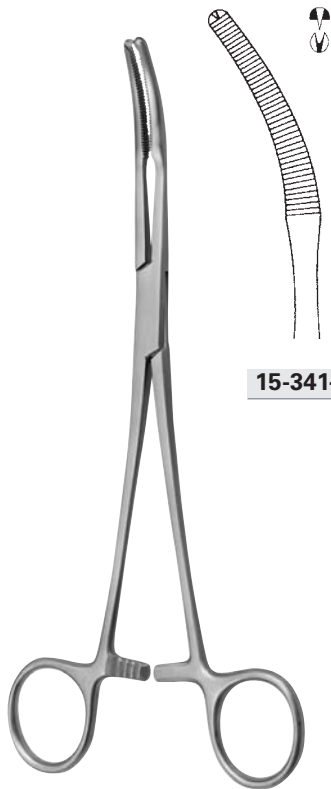

15-341-20

MIKULICZ

15-341-20 20,0 cm, 8"



15-343-14

BABY-MIKULICZ

15-343-14 14,0 cm, 5 1/2"

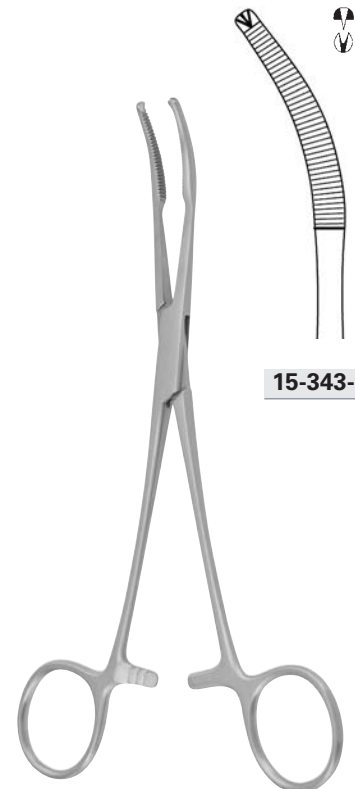

15-343-18

MIKULICZ

15-343-18 18,0 cm, 7"



15-343-19

MIKULICZ

15-343-19 18,0 cm, 7"

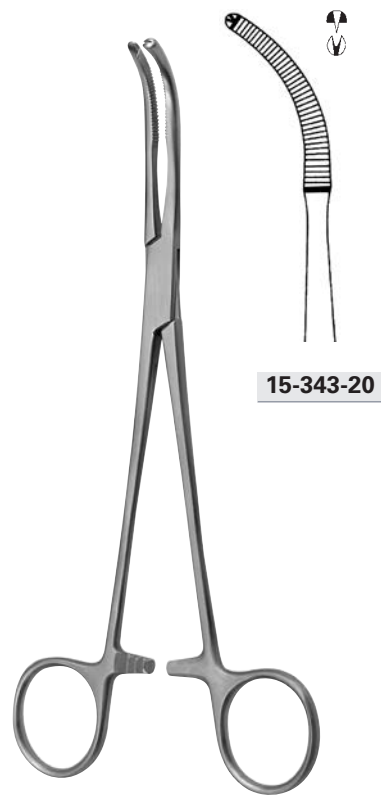

15-343-20

MIKULICZ

15-343-20 20,0 cm, 8"

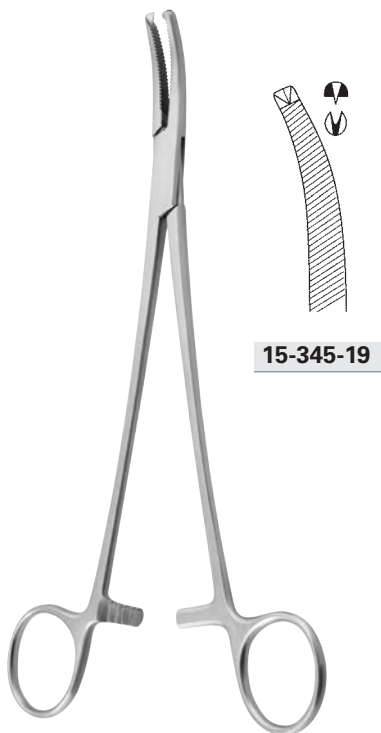

15-345-19

FAURE

15-345-19 19,0 cm, 7 1/2"
15-345-20 20,0 cm, 8"

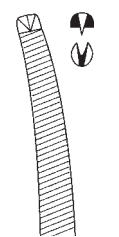

15-345-20



15-349-24

MIKULICZ

15-349-24 24,5 cm, 9 2/3"

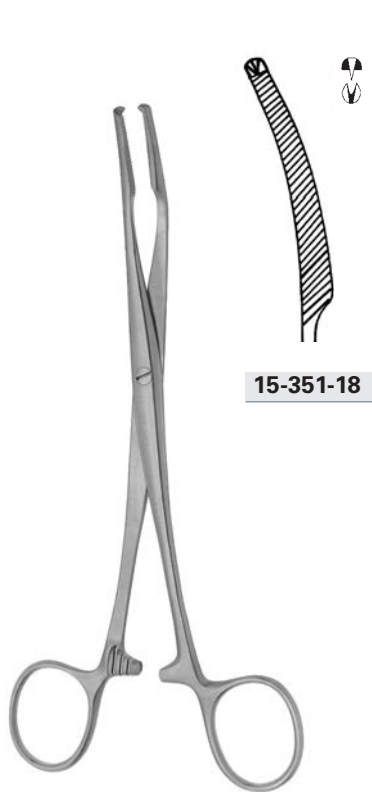

15-351-18

MIKULICZ

15-351-18 18,0 cm, 7"

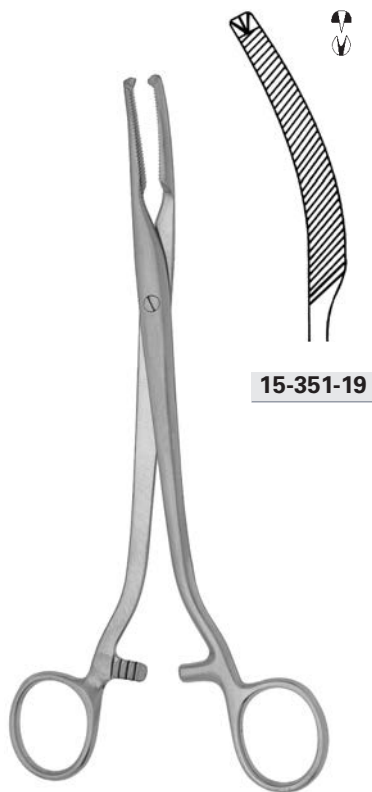

15-351-19

MIKULICZ

15-351-19 19,0 cm, 7 1/2"

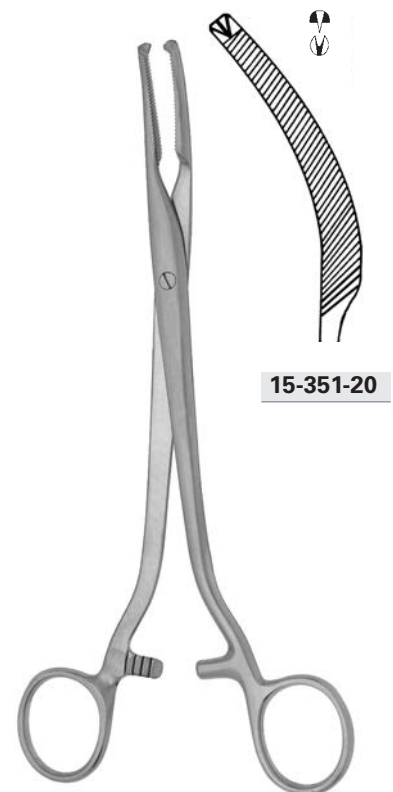

15-351-20

MIKULICZ

15-351-20 20,0 cm, 8"

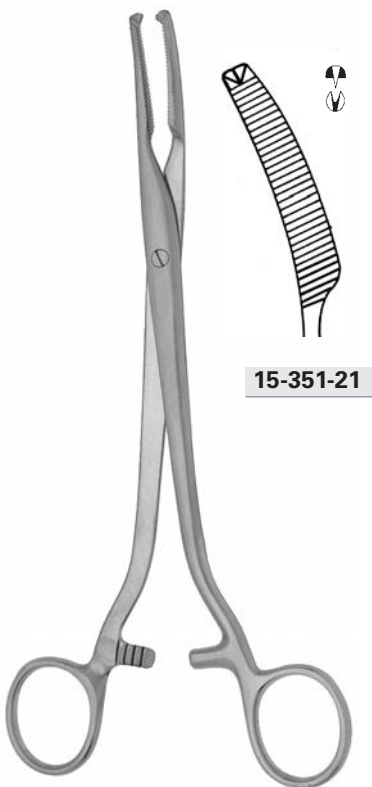

15-351-21

MIKULICZ

15-351-21 21,0 cm, 8 1/4"

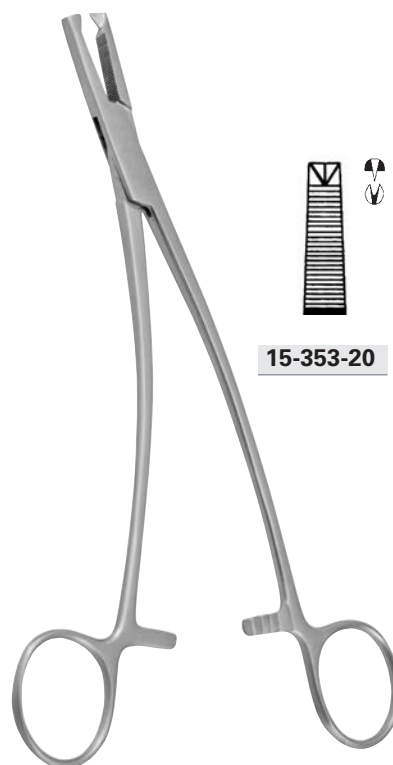

15-353-20

SCHINDLER

15-353-20 20,0 cm, 8"



15-355-22

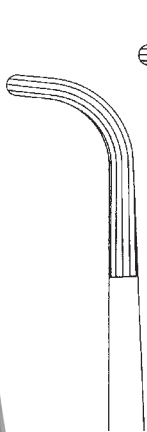

15-355-25

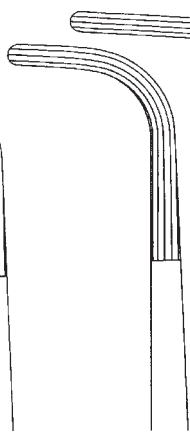

15-355-28

MIXTER

15-355-22	22,0 cm, 8 3/4"
15-355-25	25,0 cm, 9 3/4"
15-355-28	28,0 cm, 11"



15-357-24

FINOCHIETTO

15-357-24	24,0 cm, 9 1/2"
-----------	-----------------



15-359-22
15-359-23

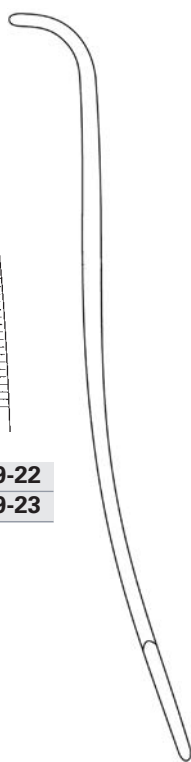
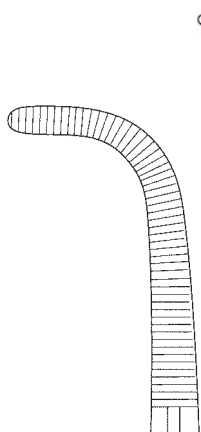

GRAY

15-359-22	22,0 cm, 8 3/4"
15-359-23	23,0 cm, 9"

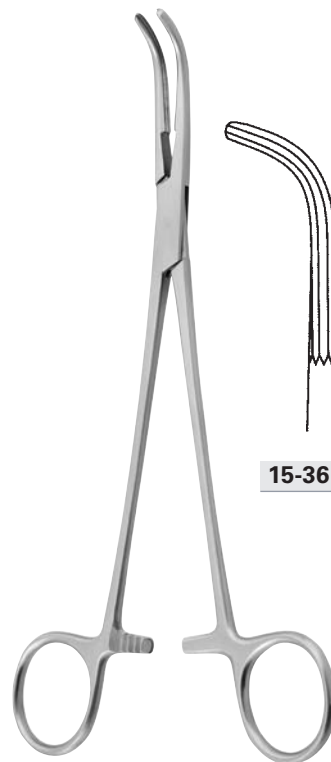

15-361-19

15-361-23

LAHEY

15-361-19	19,0 cm, 7 1/2"
15-361-23	23,0 cm, 9"

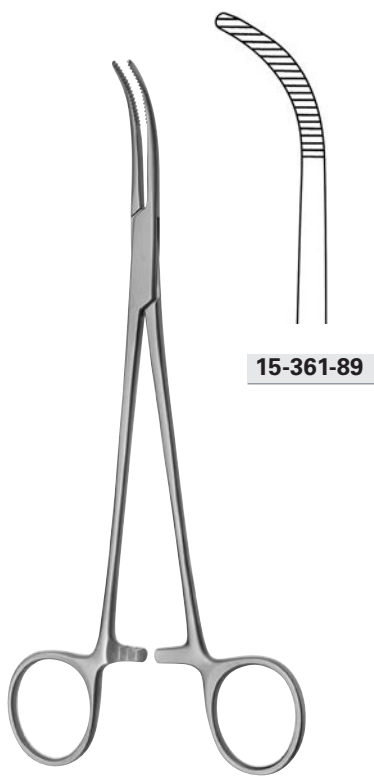

15-361-89

LAHEY

15-361-89 19,0 cm, 7 ½"

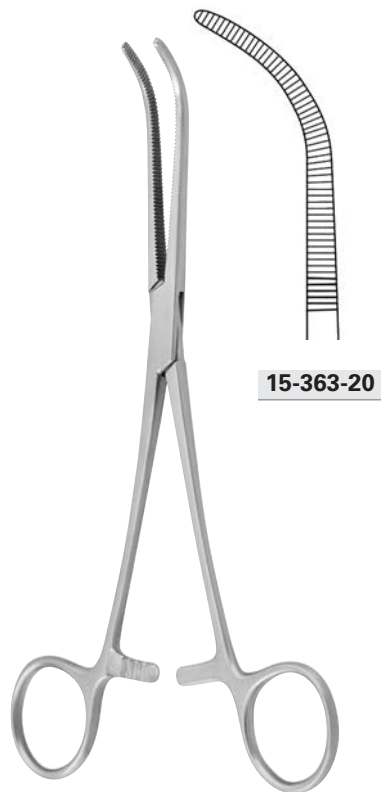

15-363-20

JOHNS-HOPKINS

15-363-20 20,0 cm, 8"

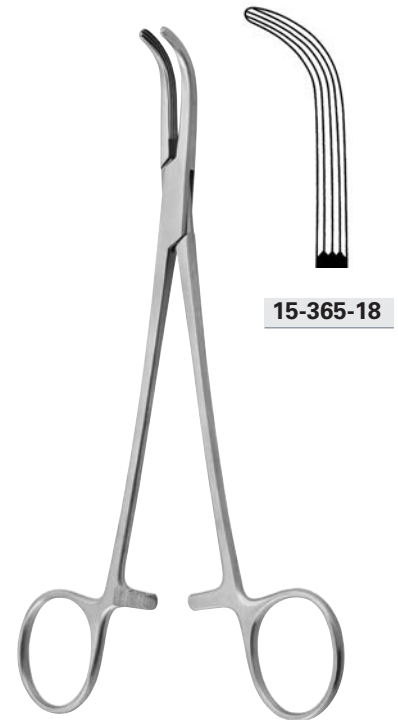

15-365-18

LOWER

15-365-18 18,0 cm, 7"

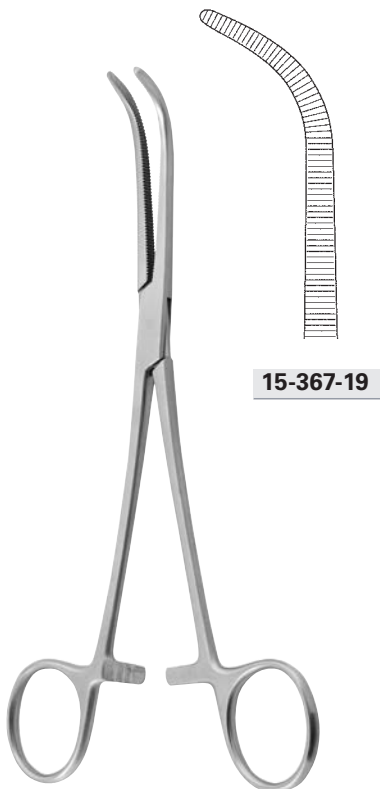

15-367-19

MIXTER-O'SHAUGNESSY

15-367-19 19,0 cm, 7 ½"

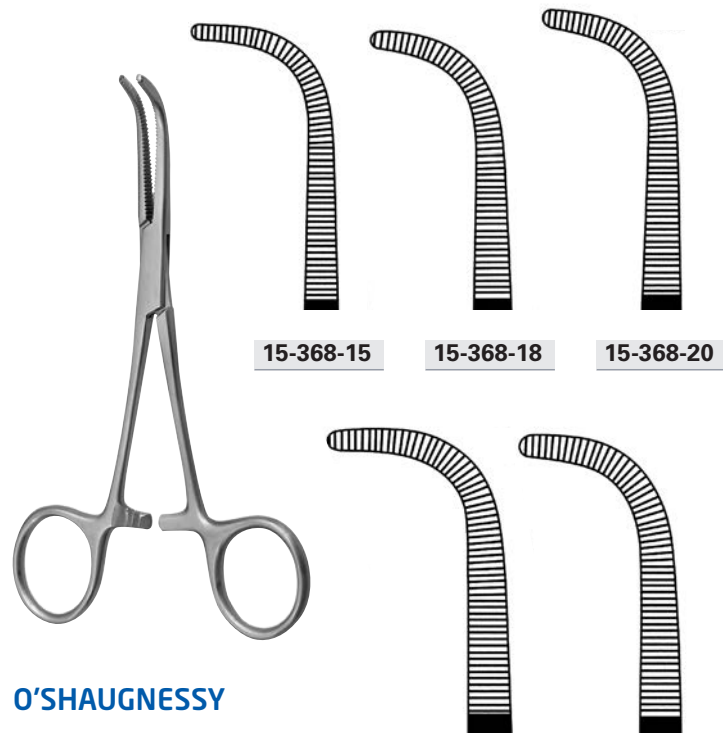

O'SHAUGNESSY

15-368-15 15,0 cm, 6"

15-368-18 18,0 cm, 7"

15-368-20 20,0 cm, 8"

15-368-23 23,0 cm, 9"

15-368-25 25,0 cm, 10"

15-368-23

15-368-25

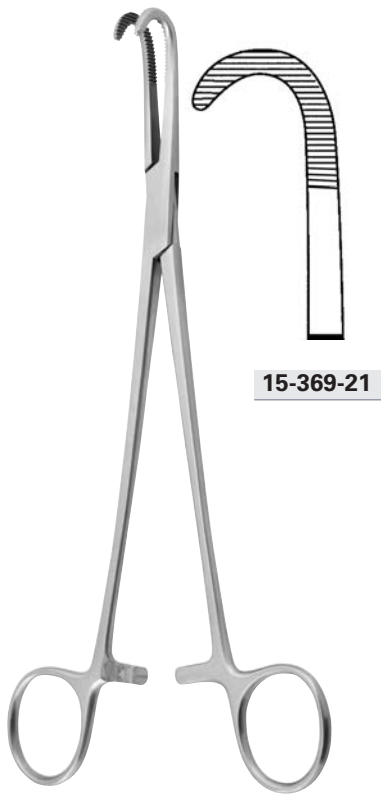

15-369-21

DESJARDINS

15-369-21 21,0 cm, 8 ¼"



15-371-18

15-371-19

NEGUS

15-371-18 18,0 cm, 7"
15-371-19 19,0 cm, 7 ½"

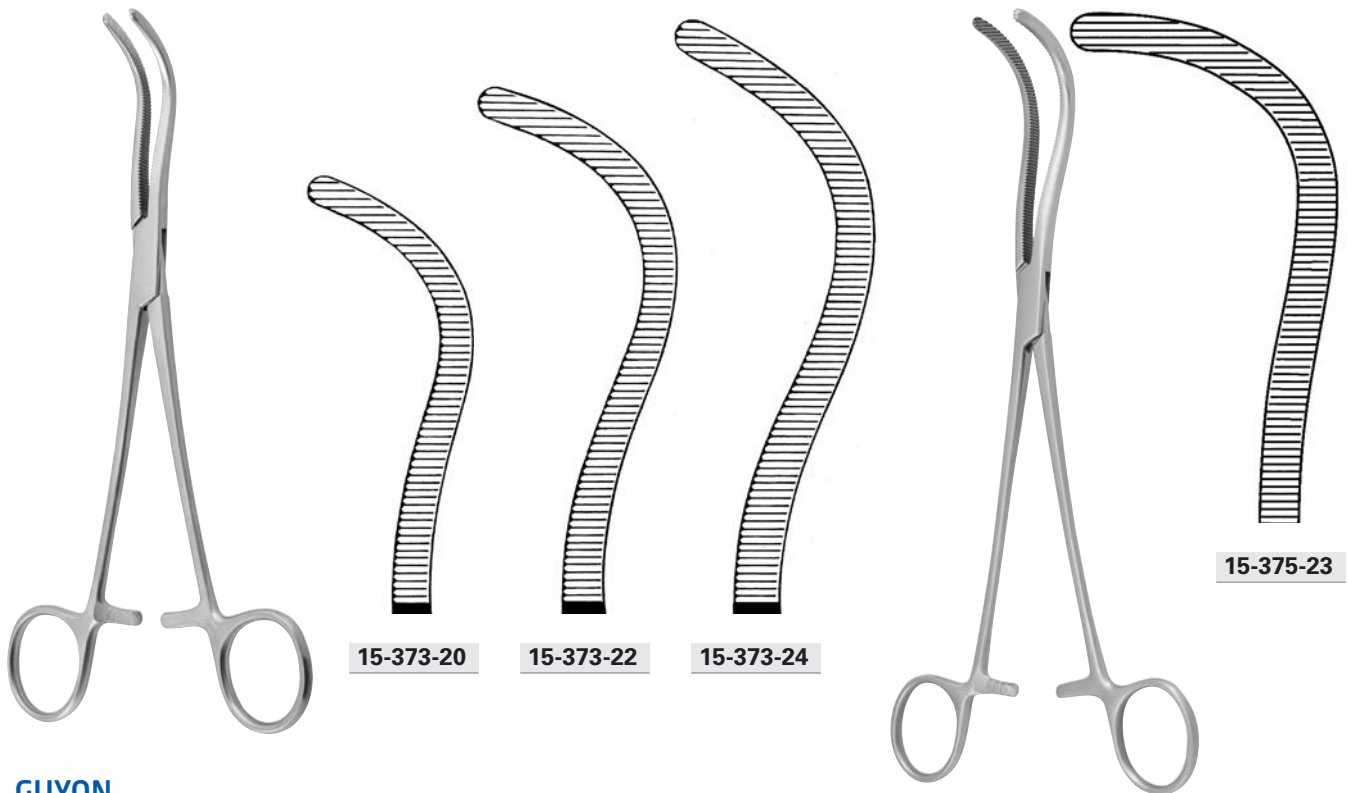

15-373-20

15-373-22

15-373-24

15-375-23

GUYON

15-373-20 20,0 cm, 8"
15-373-22 22,0 cm, 8 ¾"
15-373-24 24,0 cm, 9 ½"

GUYON

15-375-23 23,0 cm, 9"

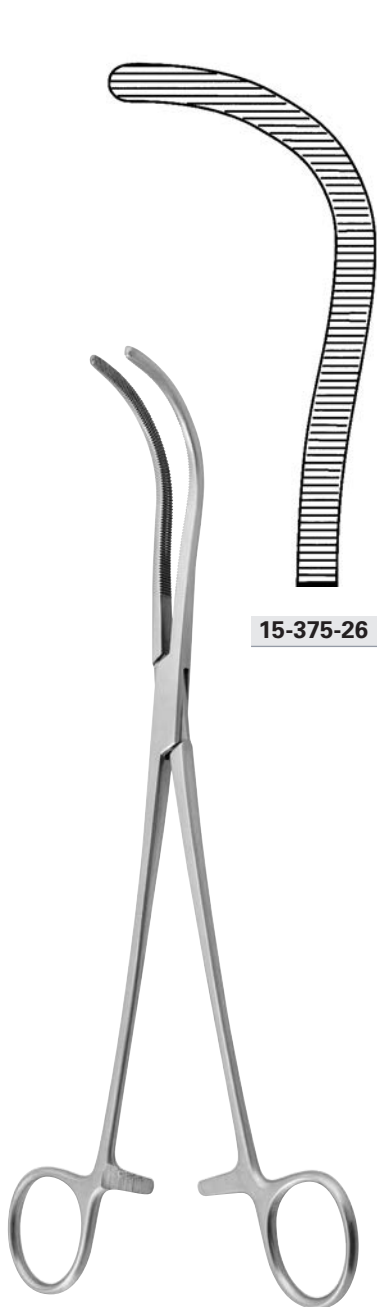

15-375-26

GUYON

15-375-26 26,5 cm, 10 1/2"



15-377-23

STILLE

15-377-23 23,0 cm, 9"



15-379-23

HERRICK

15-379-23 23,0 cm, 9"

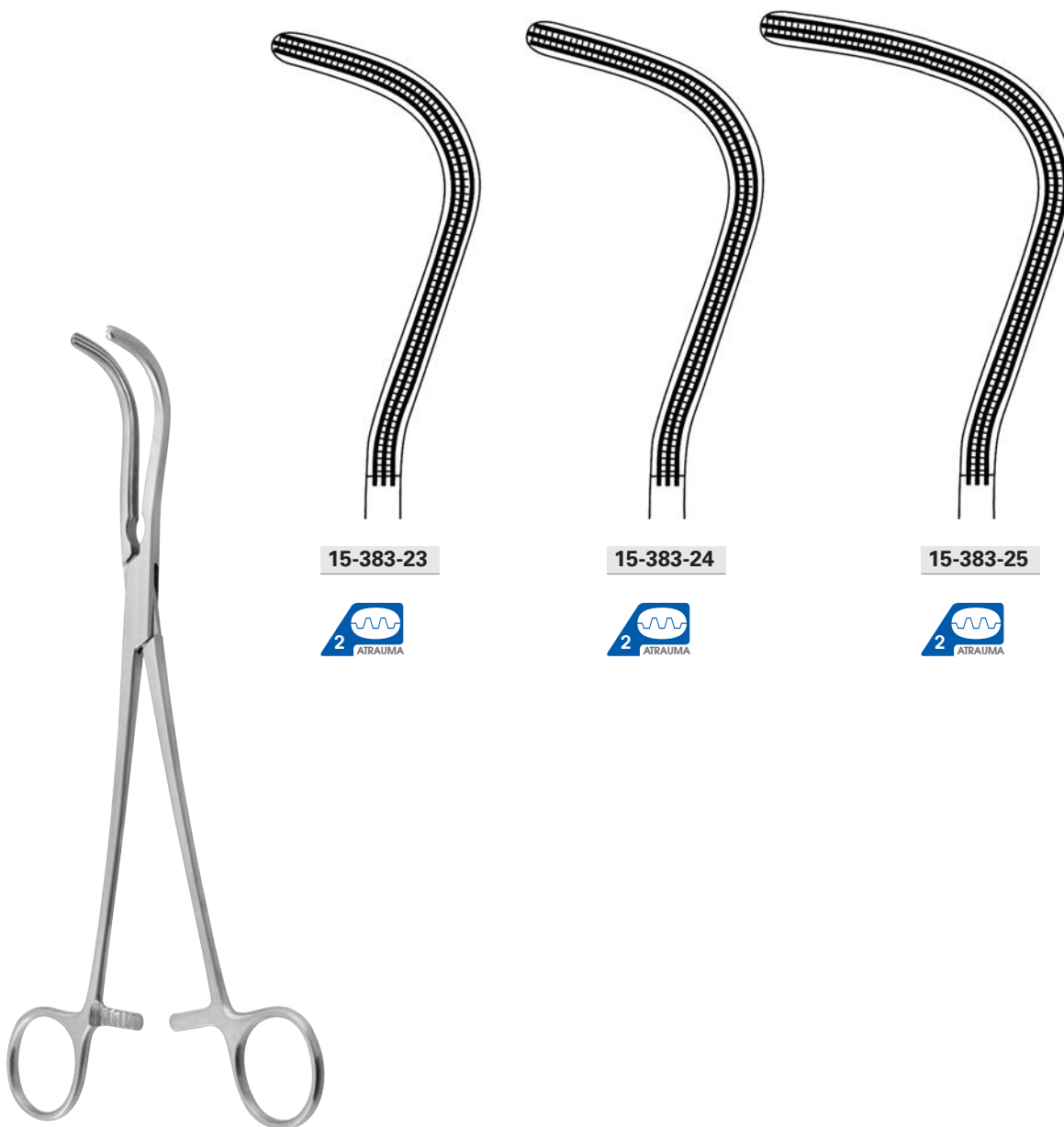

GUYON

15-383-23	23,0 cm, 9"
15-383-24	24,0 cm, 9 ½"
15-383-25	24,0 cm, 9 ½"

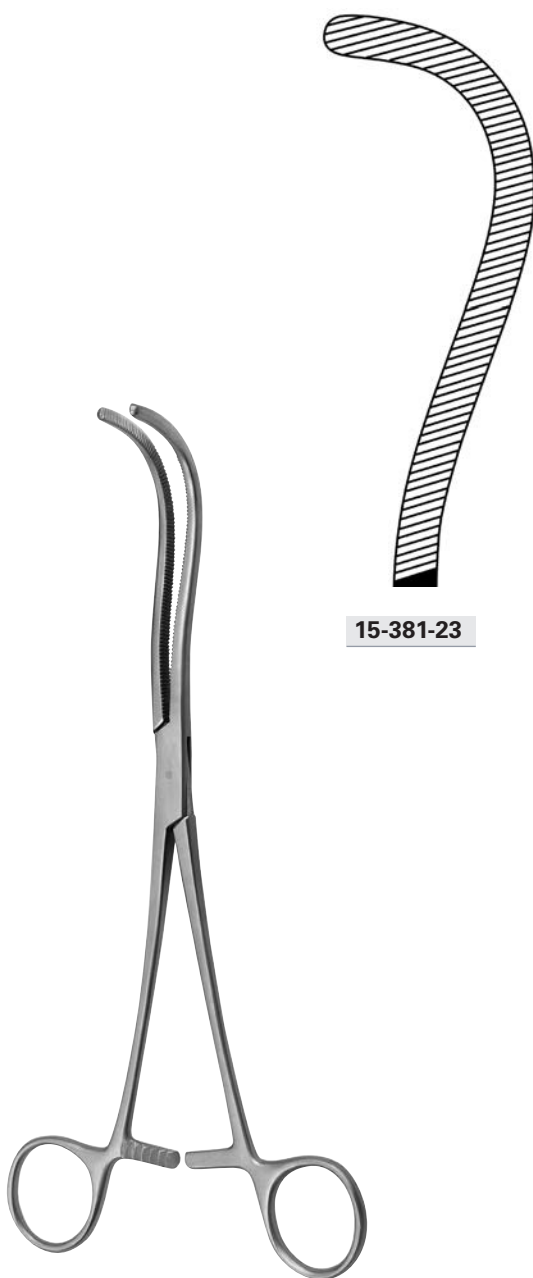

15-381-23

MAYO-GUYON

15-381-23 23,0 cm, 9"

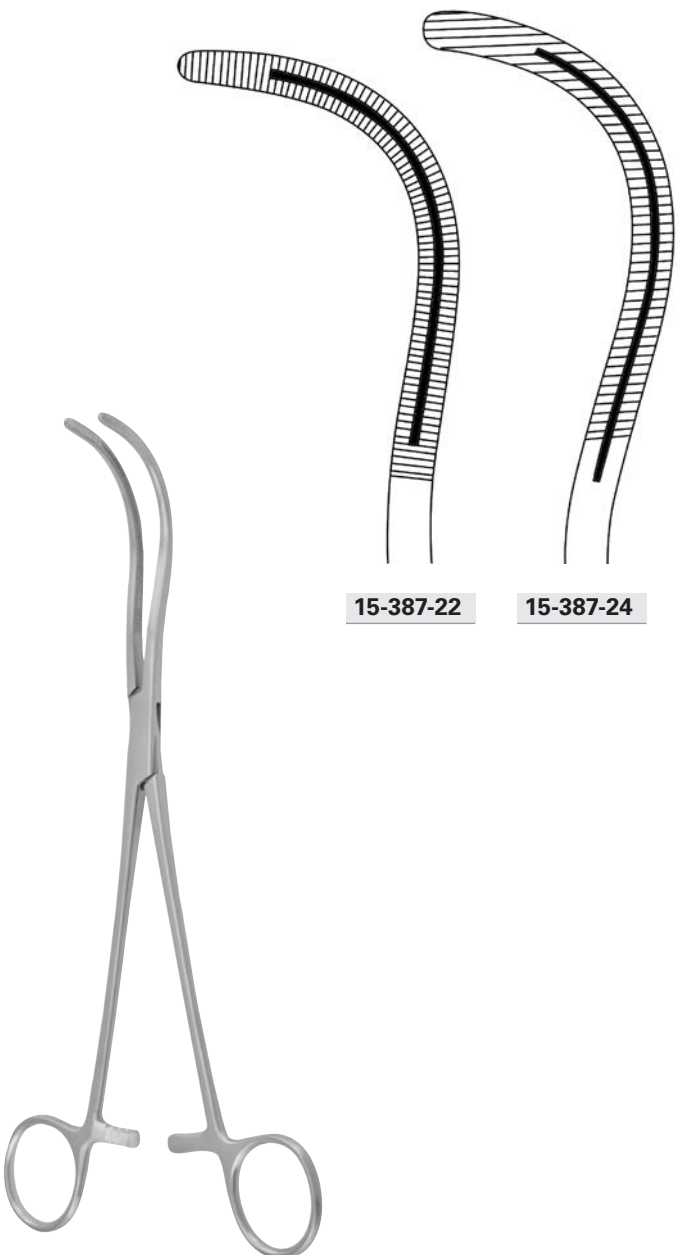

15-387-22

15-387-24

STILLE

15-387-22 22,0 cm, 8 3/4"

15-387-24 24,0 cm, 9 1/2"

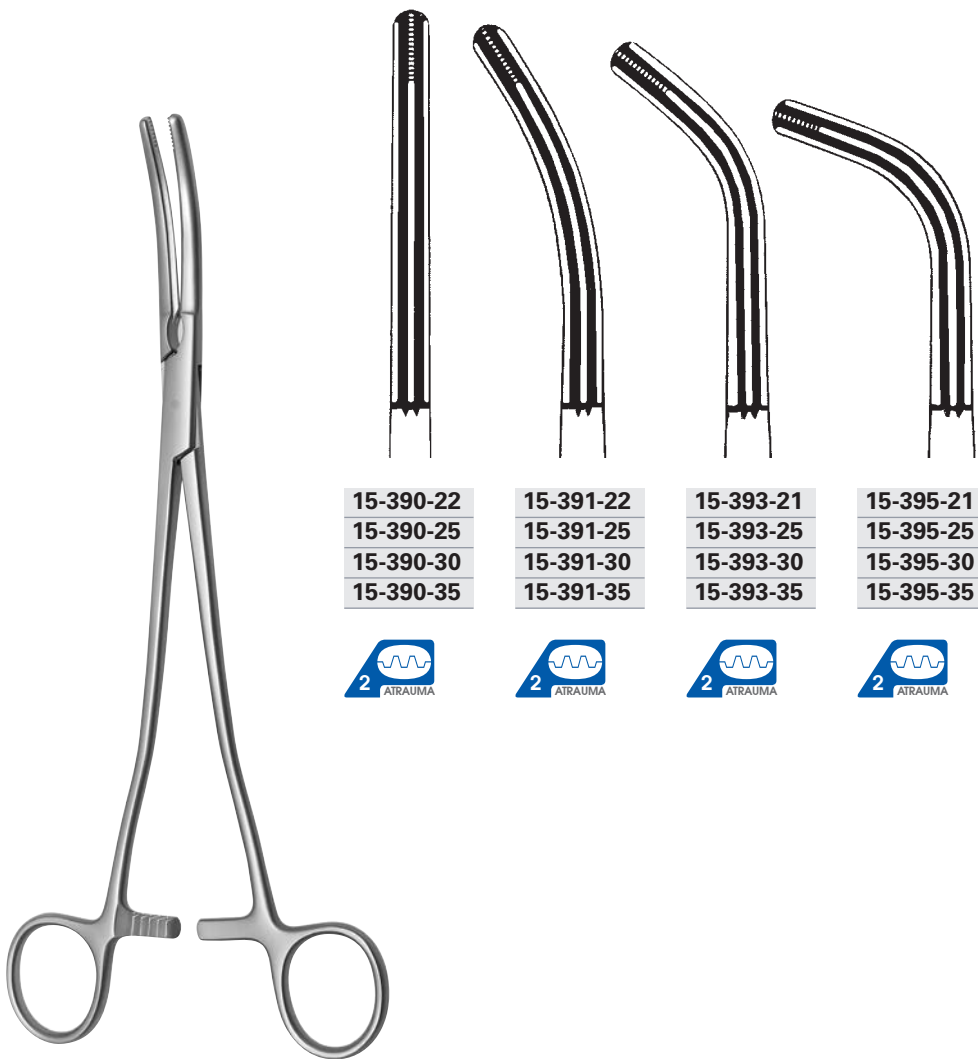

15-390-22
15-390-25
15-390-30
15-390-35

15-391-22
15-391-25
15-391-30
15-391-35

15-393-21
15-393-25
15-393-30
15-393-35

15-395-21
15-395-25
15-395-30
15-395-35



Z-PARAMETRIUM

15-391-22 - 15-395-21	21,0 cm, 8 1/4"
15-390-22 - 15-393-22	22,0 cm, 8 3/4"
15-390-25 - 15-395-22	25,0 cm, 9 3/4"
15-390-30 - 15-395-30	30,0 cm, 11 3/4"
15-390-35 - 15-395-35	35,0 cm, 13 3/4"



15



Mikro Instrumente

Micro Instruments

Instrumentos de micro

Strumentario micro

Fordern Sie unser Spezialprospekt an
Please ask for our special catalogue
No duden pedirnos más catálogos especiales
Chiedete i nostri cataloghi speciali



DE BAKEY

15-492-50 50,0 mm



15-494-08



15-494-09



15-494-10



15-494-12



DE BAKEY

15-494-08 80,0 mm

15-494-09 90,0 mm

15-494-10 105,0 mm

15-494-12 124,0 mm



DE BAKEY

15-493-48 48,0 mm



15-495-08



15-495-09



15-495-10



15-495-11



DE BAKEY

15-495-08 78,0 mm

15-495-09 86,0 mm

15-495-10 97,0 mm

15-495-11 114,0 mm



DE BAKEY

15-494-07 T	70,0 mm
15-494-08 T	80,0 mm
15-494-09 T	90,0 mm
15-494-10 T	100,0 mm
15-494-11 T	110,0 mm
15-494-12 T	120,0 mm
15-494-13 T	130,0 mm

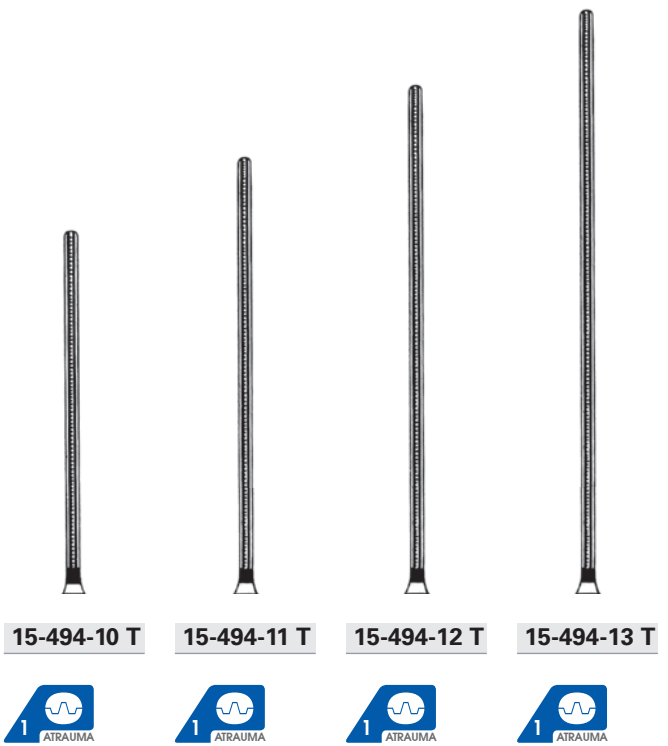

DE BAKEY

15-495-07 T	70,0 mm
15-495-08 T	80,0 mm
15-495-09 T	90,0 mm
15-495-10 T	100,0 mm
15-495-11 T	110,0 mm
15-495-12 T	120,0 mm
15-495-13 T	130,0 mm

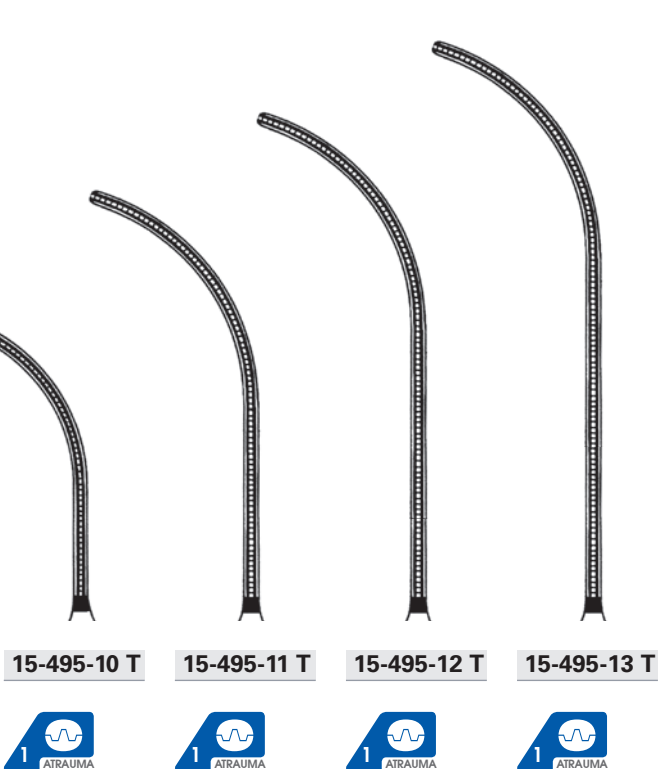

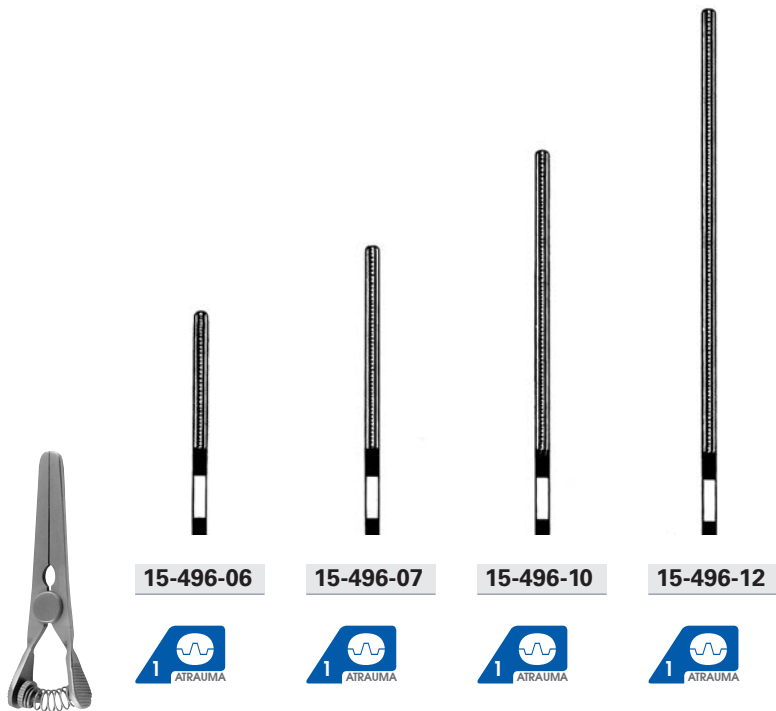

15-496-06

15-496-07

15-496-10

15-496-12



GLOVER

15-496-06	60,0 mm
15-496-07	68,0 mm
15-496-10	96,0 mm
15-496-12	117,0 mm

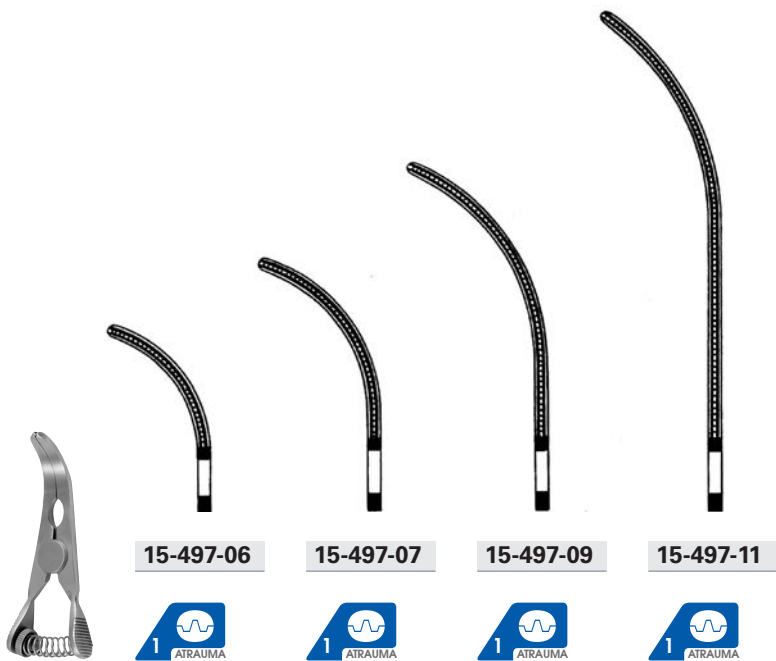

15-497-06

15-497-07

15-497-09

15-497-11



GLOVER

15-497-06	55,0 mm
15-497-07	65,0 mm
15-497-09	91,0 mm
15-497-11	110,0 mm

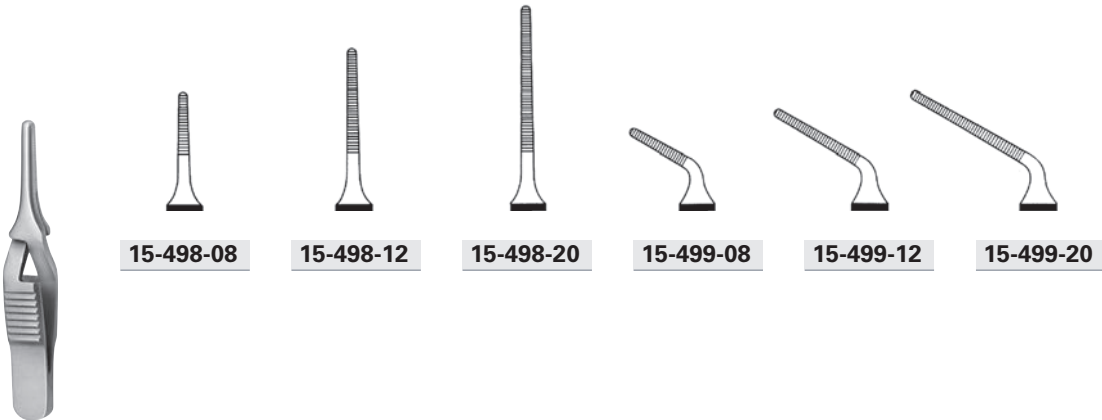

15-498-08

15-498-12

15-498-20

15-499-08

15-499-12

15-499-20

DIETHRICH

15-498-08 - 15-499-08 8,0 mm

15-498-12 - 15-499-12 12,0 mm

15-498-20 - 15-499-20 20,0 mm

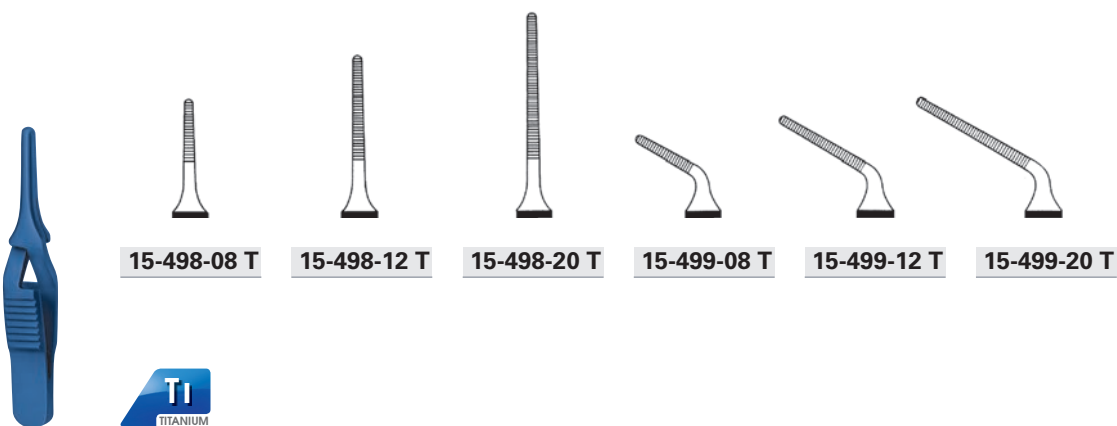

15-498-08 T

15-498-12 T

15-498-20 T

15-499-08 T

15-499-12 T

15-499-20 T

DIETHRICH

15-498-08 T - 15-499-08 T 8,0 mm

15-498-12 T - 15-499-12 T 12,0 mm

15-498-20 T - 15-499-20 T 20,0 mm

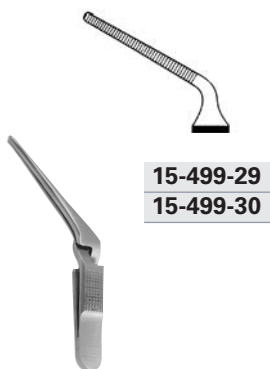

15-499-29
15-499-30

HESS

15-499-29	20,0 mm
15-499-30	30,0 mm

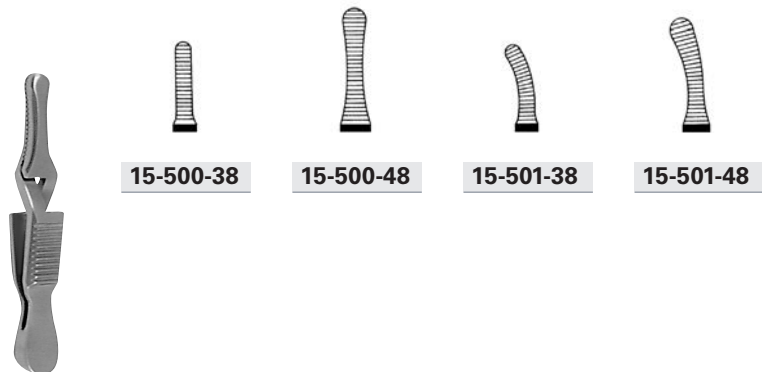

15-500-38

15-500-48

15-501-38

15-501-48

DIEFFENBACH

15-500-38 - 15-501-38	38,0 mm
15-500-48 - 15-501-48	48,0 mm

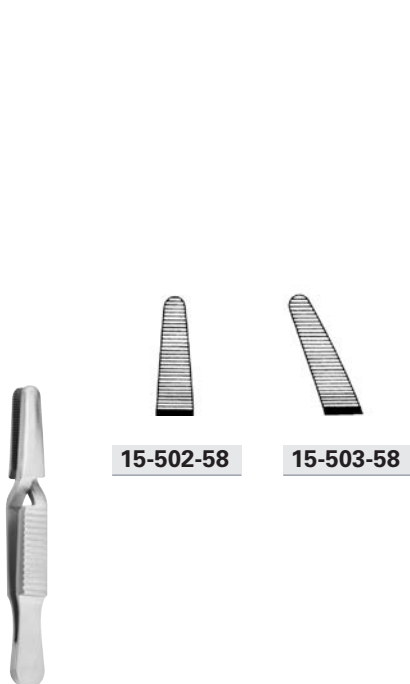

15-502-58

15-503-58

DIEFFENBACH

15-502-58 - 15-503-58	58,0 mm
-----------------------	---------

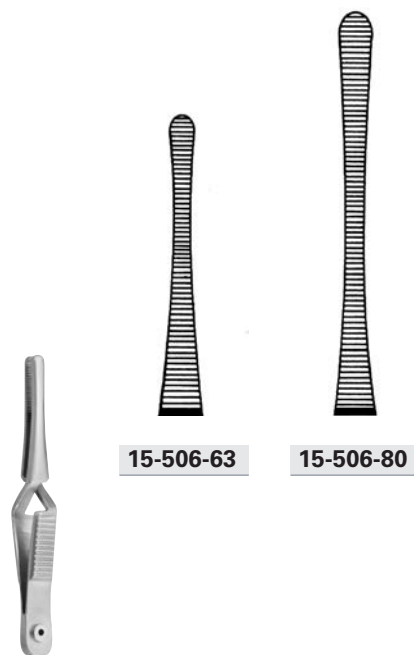

15-506-63

15-506-80

JOHN-HOPKINS

15-506-63	63,0 mm
15-506-80	80,0 mm



15-505-38

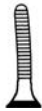

15-505-48

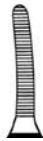

15-505-56



15-505-63



15-505-70



15-505-80



15-505-91



JOHN-HOPKINS

15-505-38	38,0 mm
15-505-48	48,0 mm
15-505-56	56,0 mm
15-505-63	63,0 mm
15-505-70	70,0 mm
15-505-80	80,0 mm
15-505-91	91,0 mm



Anlegezange für Bulldogklemmen
 15-494-08 - 15-495-11 & 15-505-38 - 15-506-80
 Applying forceps for bulldog clamps
 15-494-08 - 15-495-11 & 15-505-38 - 15-506-80
 Pinza para poner los clamps bulldog
 15-494-08 - 15-495-11 & 15-505-38 - 15-506-80
 Pinza per applicare le pinze bulldog
 15-494-08 - 15-495-11 & 15-505-38 - 15-506-80

JOHN-HOPKINS

15-507-24 24,0 cm, 9 1/2 "

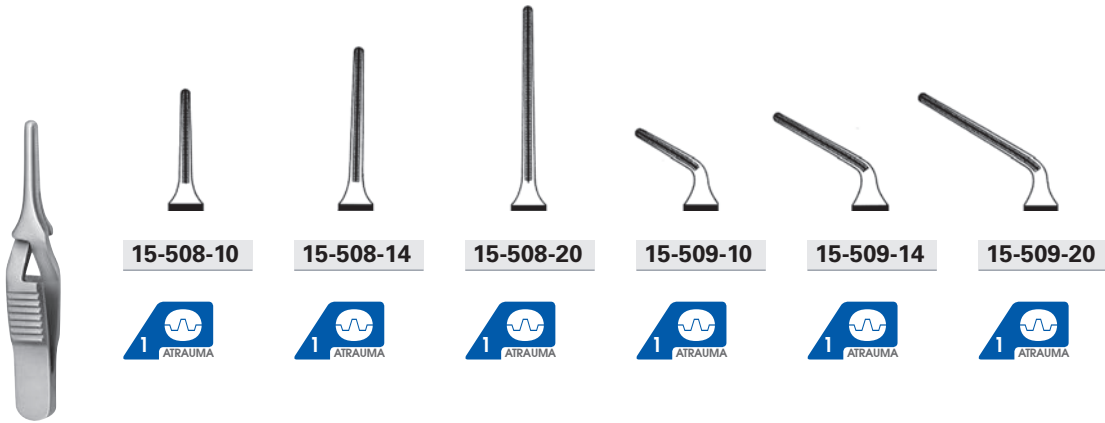

DE BAKEY-DIETHRICH

15-508-10 - 15-509-10	10,0 mm
15-508-14 - 15-509-14	14,0 mm
15-508-20 - 15-509-20	20,0 mm



DE BAKEY-DIETHRICH

15-508-10 T - 15-509-10 T	10,0 mm
15-508-14 T - 15-509-14 T	14,0 mm
15-508-20 T - 15-509-20 T	20,0 mm



15-522-40

15-522-50



15-526-40

15-526-50



15-522-30

15-522-35



15-526-30

15-526-35



VENA

15-522-30	30,0 mm
15-522-35	35,0 mm
15-522-40	40,0 mm
15-522-50	50,0 mm

ARTERIA

15-526-30	30,0 mm
15-526-35	35,0 mm
15-526-40	40,0 mm
15-526-50	50,0 mm



15-523-40

15-523-50



15-527-40

15-527-50



15-523-30

15-523-35



15-527-30

15-527-35



VENA

15-523-30	30,0 mm
15-523-35	35,0 mm
15-523-40	40,0 mm
15-523-50	50,0 mm

ARTERIA

15-527-30	30,0 mm
15-527-35	35,0 mm
15-527-40	40,0 mm
15-527-50	50,0 mm



15-525-40



15-525-50



15-529-40



15-529-50



15-525-30



15-525-35



15-529-30



15-529-35



VENA

15-525-30	30,0 mm
15-525-35	35,0 mm
15-525-40	40,0 mm
15-525-50	50,0 mm

ARTERIA

15-529-30	30,0 mm
15-529-35	35,0 mm
15-529-40	40,0 mm
15-529-50	50,0 mm



Anlege- und Entfernungszange für TITAN Bulldogklemmen 15-522-30 - 15-529-50

Applying and removing forceps for TITANIUM bulldog clamps 15-522-30 - 15-529-50

Pinza para poner y quitar TITANIUM clamps bulldog 15-522-30 - 15-529-50

Pinze metti-rimuovi TITANIUM clamps bulldog 15-522-30 - 15-529-50



15-531-05



15-533-07



GLOVER

15-531-05 50,0 mm

SANTULLI

15-533-07 70,0 mm

15-530-24 24,0 cm, 9 1/2 "



15-535-09

15-535-11



15-537-01

15-537-02

links
 left
 izquierdo
 sinistro

rechts
 right
 derecho
 destro



GREGORY-SOFT

15-535-09	90,0 mm
15-535-11	110,0 mm

GREGORY-SOFT

15-537-01 - 15-537-02	110,0 mm
-----------------------	----------



15-539-07



15-539-09

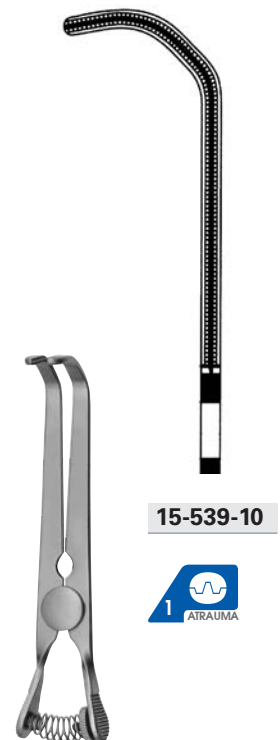

15-539-10



DE BAKEY-SATINSKY

15-539-07	70,0 mm
-----------	---------

DE BAKEY-CAROTIS

15-539-09	90,0 mm
-----------	---------

DE BAKEY-SATINSKY

15-539-10	100,0 mm
-----------	----------

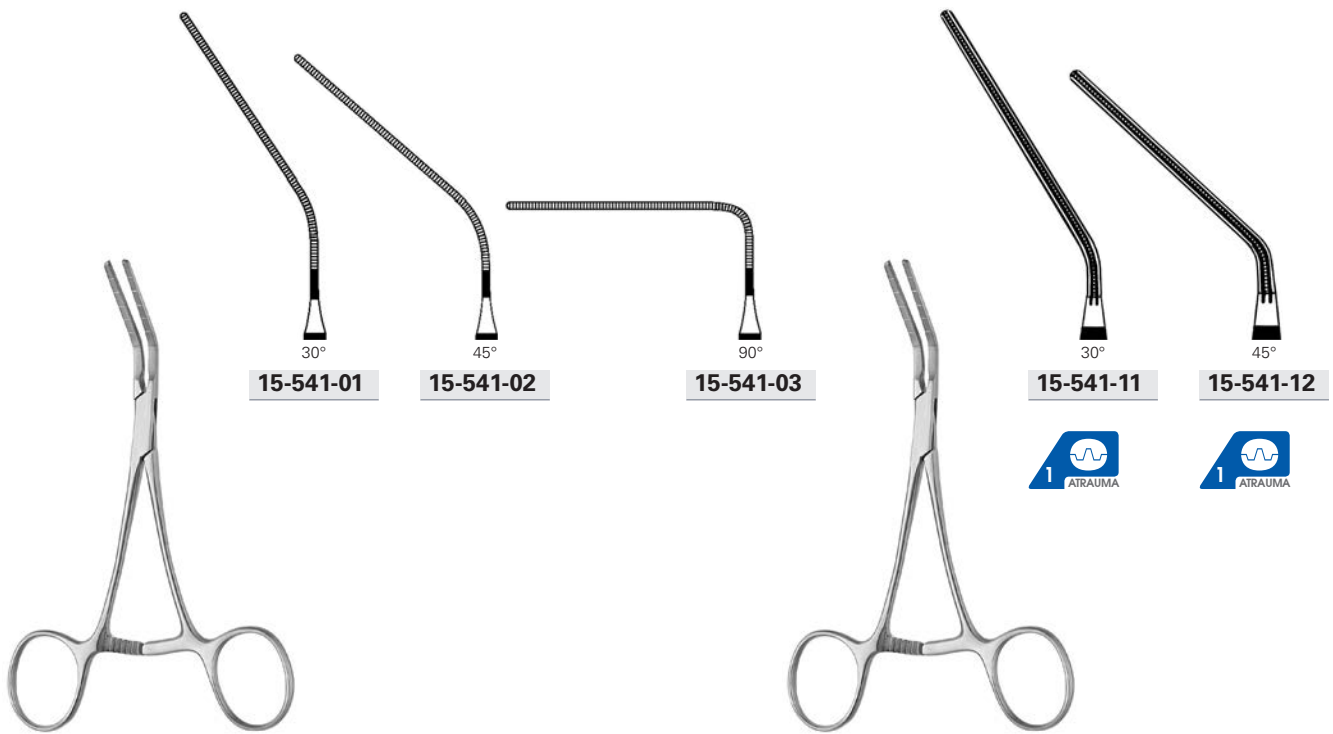

CASTANEDA

15-541-01	12,5 cm, 5 "
15-541-02	11,5 cm, 4 1/2 "
15-541-03	11,0 cm, 4 3/8 "

CASTANEDA

15-541-11	12,0 cm, 4 3/4 "
15-541-12	12,0 cm, 4 3/4 "

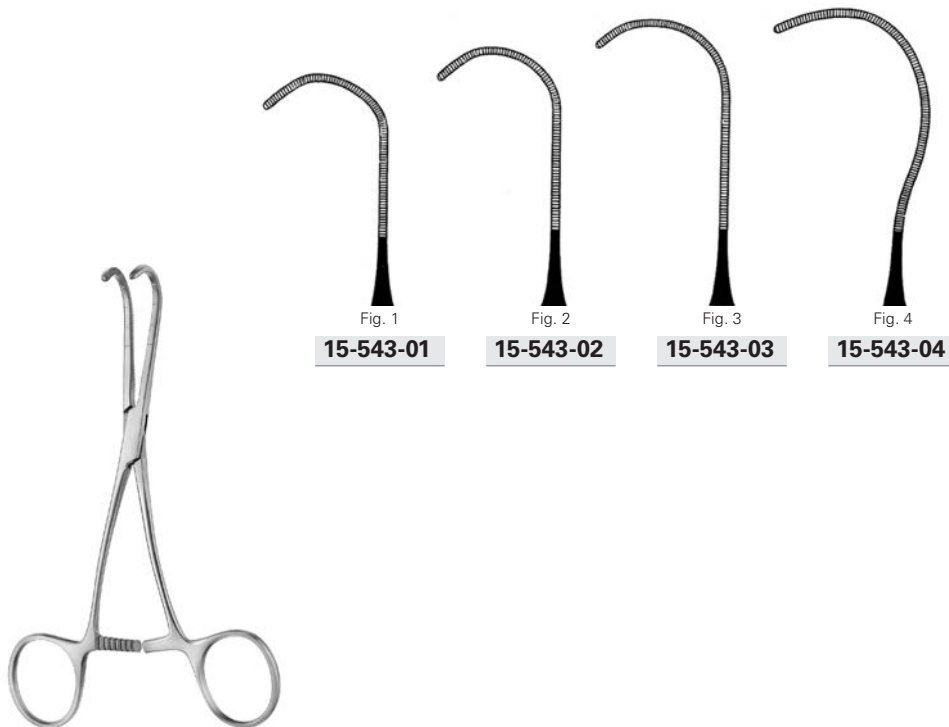

CASTANEDA

15-543-01	11,5 cm, 4 1/2 "
15-543-02 - 15-543-04	12,0 cm, 4 3/4 "

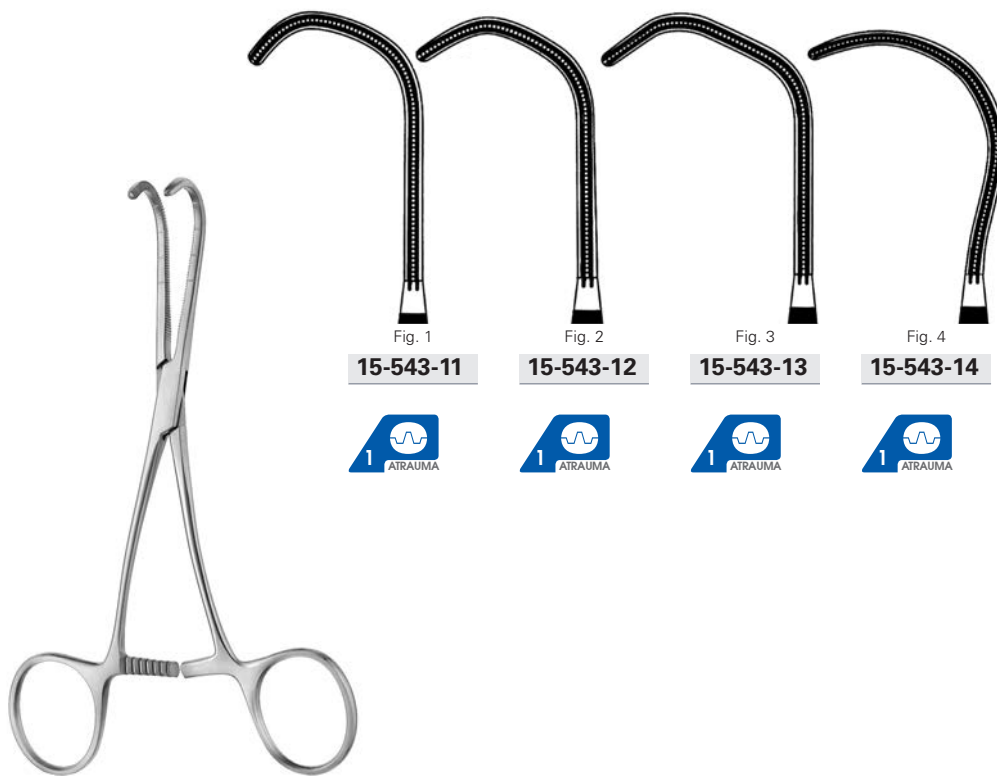

Fig. 1
15-543-11

Fig. 2
15-543-12

Fig. 3
15-543-13

Fig. 4
15-543-14

CASTANEDA

15-543-11 - 15-543-14 15,5 cm, 6 1/8"

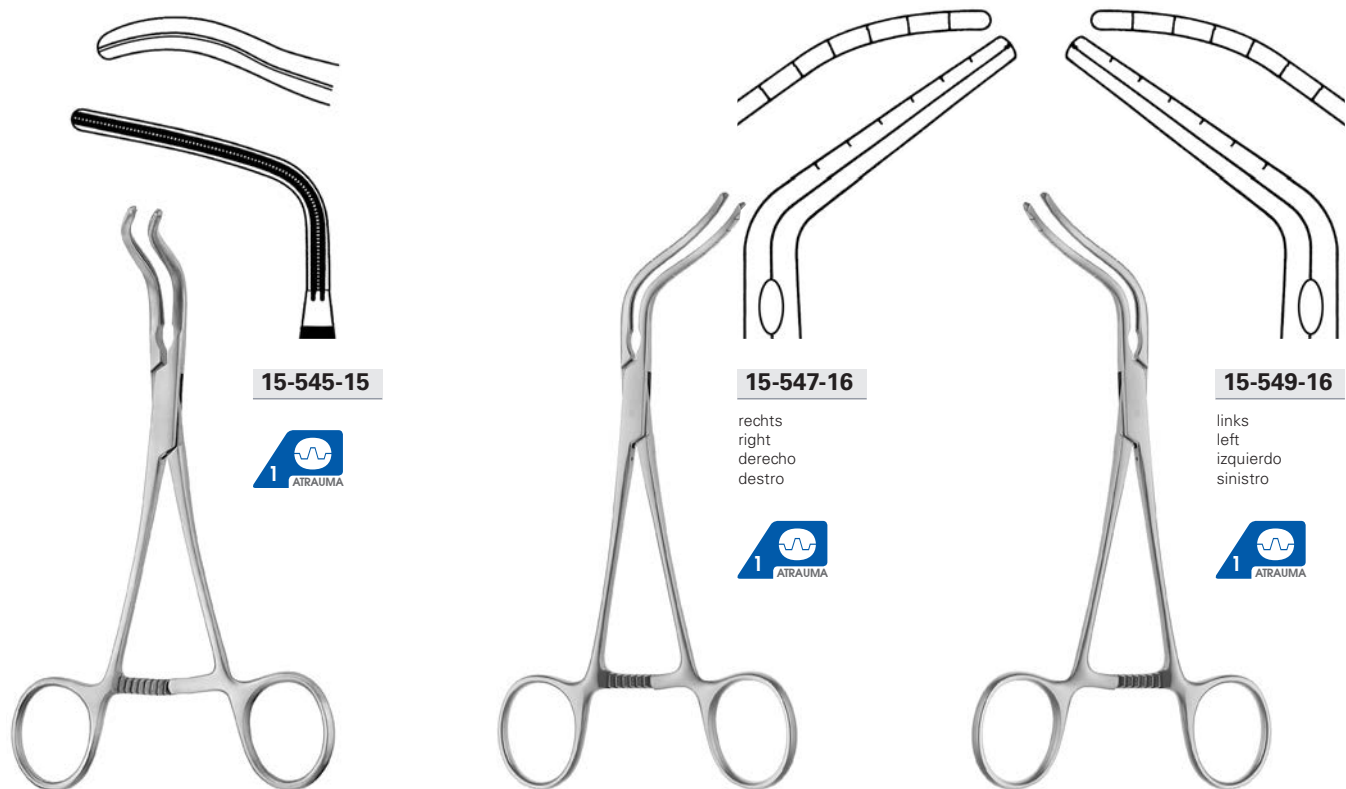

15-545-15

15-547-16

15-549-16

rechts
 right
 derecho
 destro

links
 left
 izquierdo
 sinistro

SUBRAMANIAN

15-545-15 15,5 cm, 6 1/8"

SUBRAMANIAN

15-547-16 16,0 cm, 6 1/4"

SUBRAMANIAN

15-549-16 16,0 cm, 6 1/4"

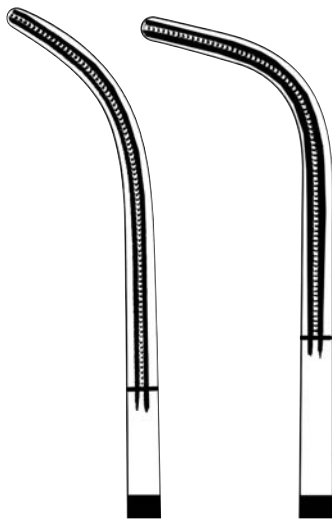

15-551-24

15-551-25



DE BAKEY-RUMEL

15-551-24 24,5 cm, 9 ²/₃ "
15-551-25 25,0 cm, 9 ³/₄ "



15-551-28



DE BAKEY-MIXTER

15-551-28 28,5 cm, 11 ¹/₄ "

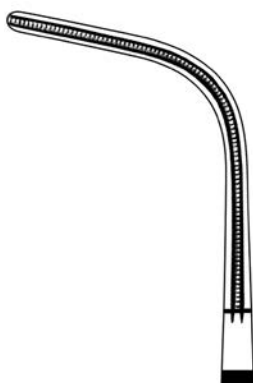

15-552-21



MC QUIGG-MIXTER

15-552-21 21,0 cm, 8 ¹/₄ "

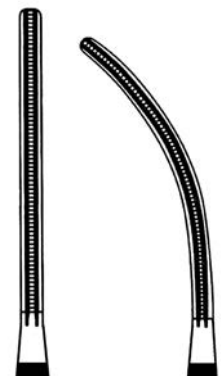

15-554-12

15-555-11



DE BAKEY

15-554-12 13,0 cm, 5 ¹/₈ "
15-555-11 12,5 cm, 5 "



15-557-10



DE BAKEY

15-557-10 10,0 cm, 4 "



15-559-12



DE BAKEY

15-559-12 12,5 cm, 5 "



15-561-13



DE BAKEY

15-561-13 12,5 cm, 5 "



15-562-17



DE BAKEY

15-562-17 17,0 cm, 6 3/4 "



15-563-16

DE BAKEY

15-563-16 16,5 cm, 6 ½"

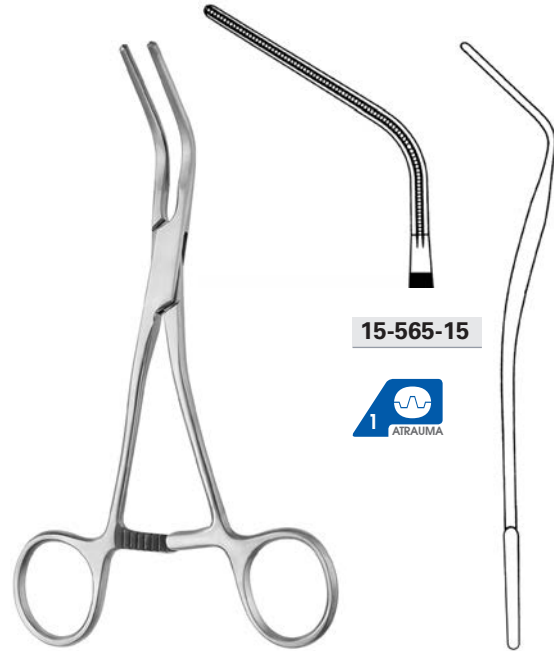

15-565-15

DE BAKEY

15-565-15 16,0 cm, 6 ¼"



15-567-15

DE BAKEY

15-567-15 15,0 cm, 6"



15-569-17

DE BAKEY

15-569-17 16,5 cm, 6 ½"



15-571-17



GLOVER

15-571-17 17,0 cm, 6 3/4"



15-573-17



GLOVER

15-573-17 17,5 cm, 7"



15-575-16



DE BAKEY

15-575-16 16,0 cm, 6 1/2"

15-575-17 17,0 cm, 6 3/4"

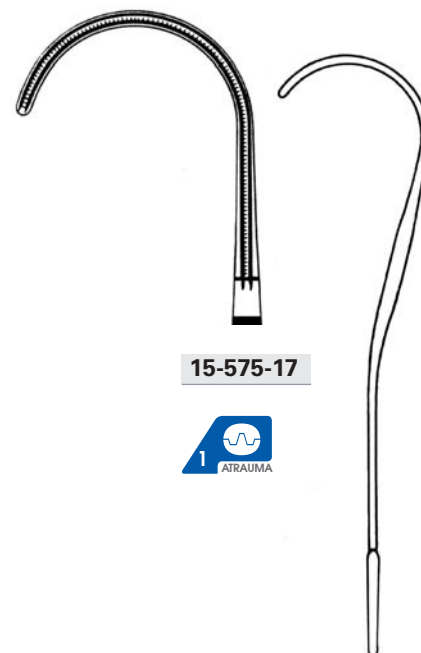

15-575-17





15-577-16

15-577-17

15-577-18



DERRA

15-577-16	16,5 cm, 6 1/2"
15-577-17	17,0 cm, 6 3/4"
15-577-18	18,0 cm, 7"

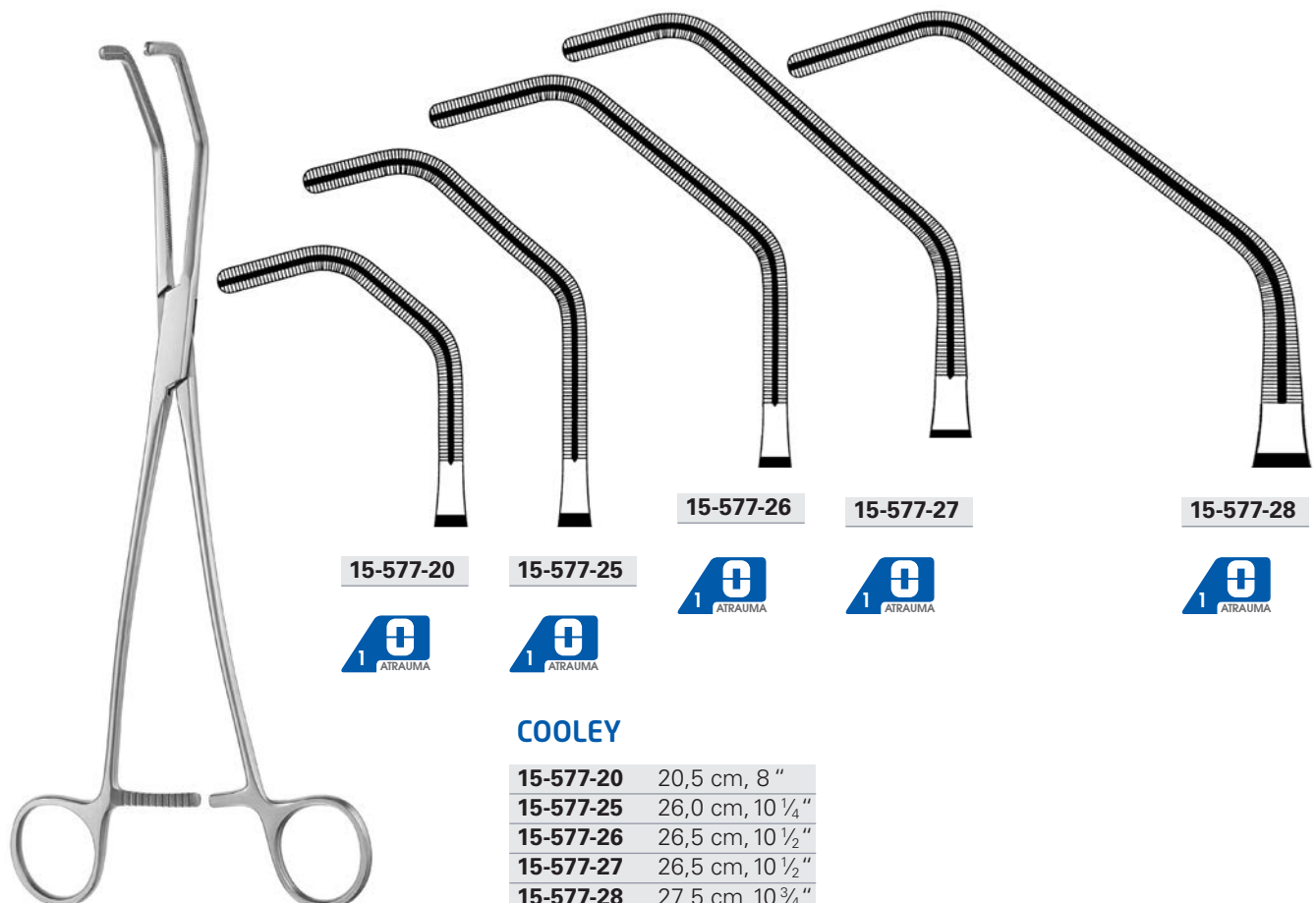

15-577-20

15-577-25

15-577-26

15-577-27

15-577-28



COOLEY

15-577-20	20,5 cm, 8"
15-577-25	26,0 cm, 10 1/4"
15-577-26	26,5 cm, 10 1/2"
15-577-27	26,5 cm, 10 1/2"
15-577-28	27,5 cm, 10 3/4"



15-578-16



COOLEY

15-578-16 16,0 cm, 6 ¼"



15-579-17



DE BAKEY-BECK

15-579-17 17,0 cm, 6 ¾"

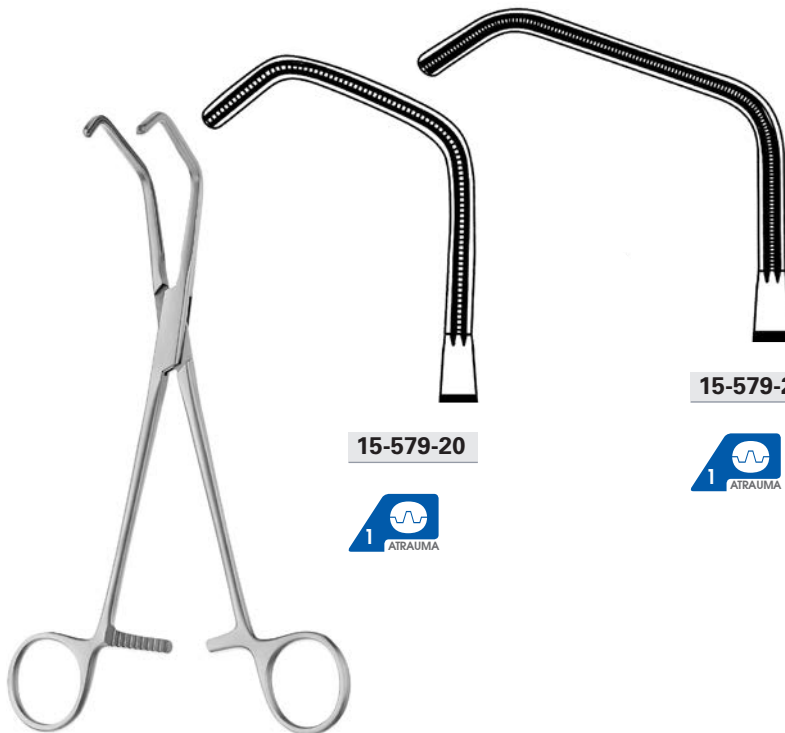

15-579-20



15-579-21



DE BAKEY-BECK

15-579-20 20,5 cm, 8"

15-579-21 21,0 cm, 8 ¼"



15-580-14



15-580-16



15-580-18



15-580-20



15-580-26



15-580-28



DE BAKEY-PEAN

15-580-14	14,0 cm, 5 1/2 "
15-580-16	16,0 cm, 6 1/4 "
15-580-18	18,0 cm, 7 "
15-580-20	20,0 cm, 8 "
15-580-26	26,0 cm, 10 1/4 "
15-580-28	28,0 cm, 11 "



15-581-14



15-581-16



15-581-18

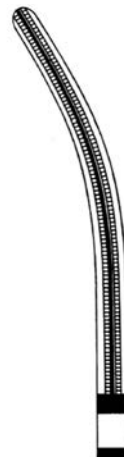

15-581-20



15-581-28



DE BAKEY-PEAN

15-581-14	14,0 cm, 5 1/2 "
15-581-16	16,0 cm, 6 1/4 "
15-581-18	18,0 cm, 7 "
15-581-20	20,0 cm, 8 "
15-581-28	28,0 cm, 11 "

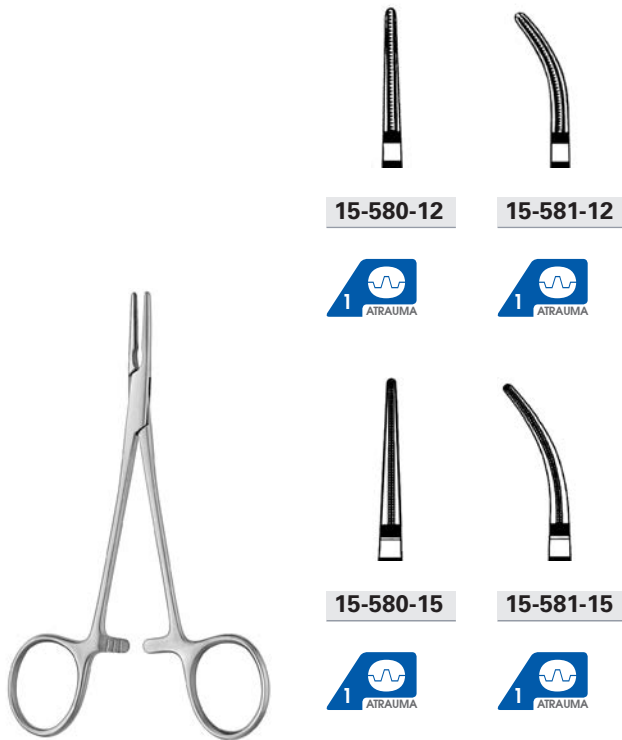

DE BAKHEY-MOSQUITO

15-580-12 - 15-581-12 12,5 cm, 5"
 15-580-15 - 15-581-15 15,5 cm, 6 1/8"



DE BAKHEY-RANKIN

15-582-16 - 15-583-16 16,0 cm, 6 1/4"



POTTS

15-584-21 21,5 cm, 8 1/2"
 15-584-23 23,5 cm, 9 1/4"
 15-584-27 27,0 cm, 10 3/4"
 15-584-31 31,0 cm, 12 1/4"

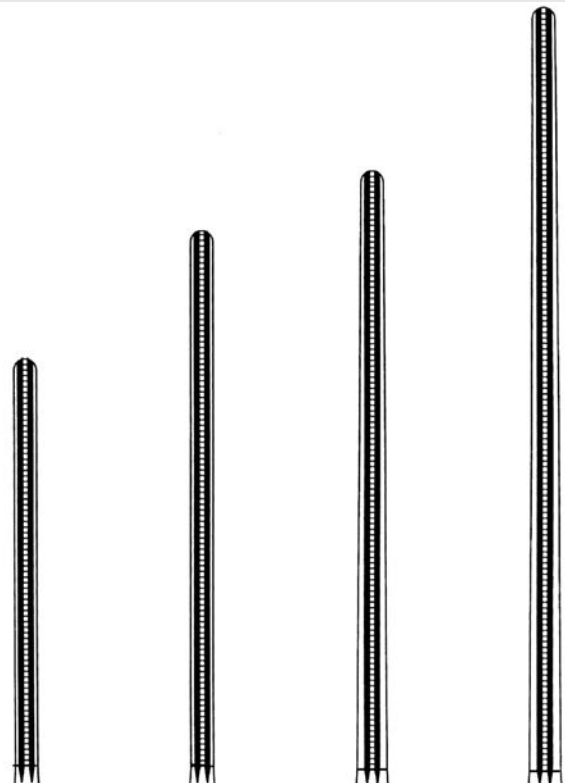

15-584-21 15-584-23 15-584-27 15-584-31

1 ATRAUMA 1 ATRAUMA 1 ATRAUMA 1 ATRAUMA

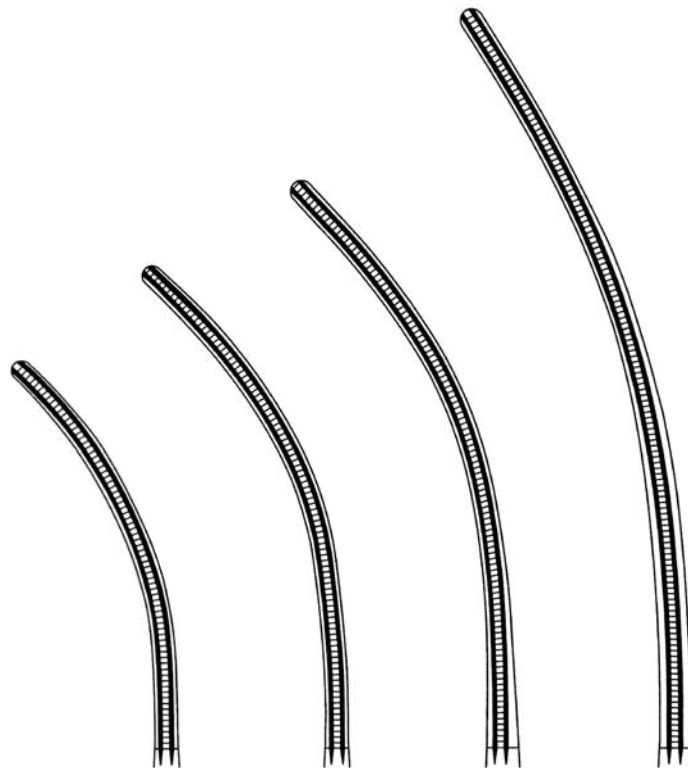

15-585-21

15-585-23

15-585-27

15-585-31



POTTS

15-585-21	21,0 cm, 8 1/4 "
15-585-23	23,0 cm, 9 "
15-585-27	26,0 cm, 10 1/4 "
15-585-31	30,5 cm, 12 "

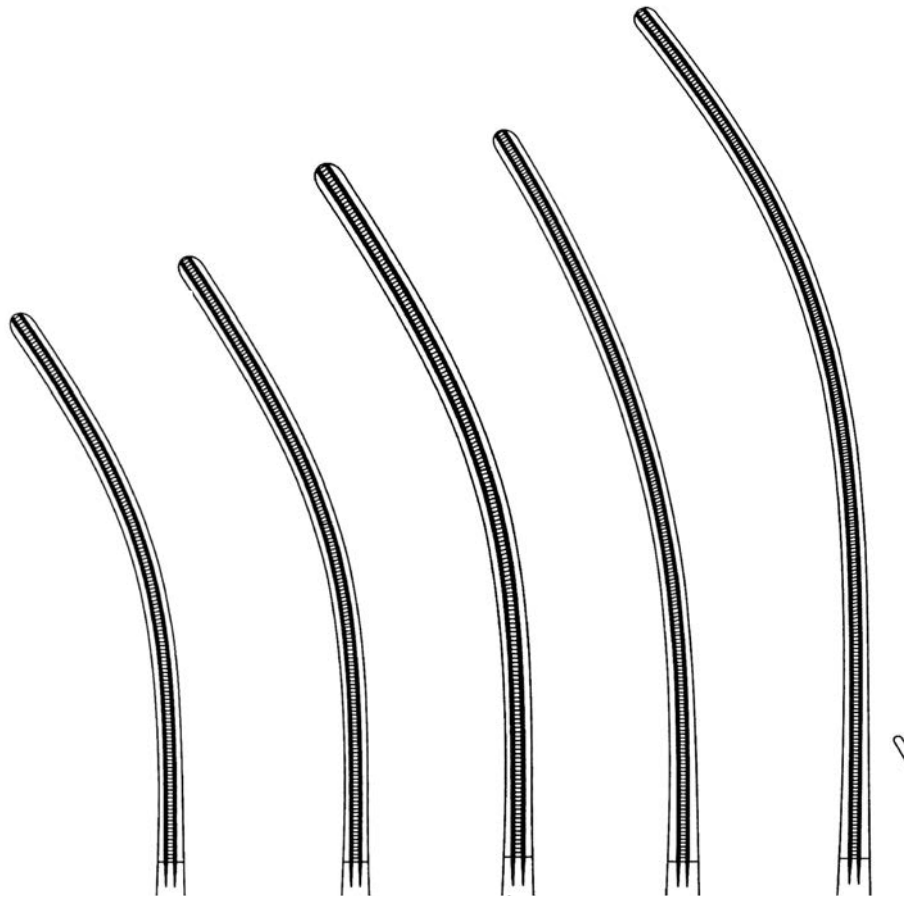

15-587-25

15-587-27

15-587-30

15-587-31

15-587-33

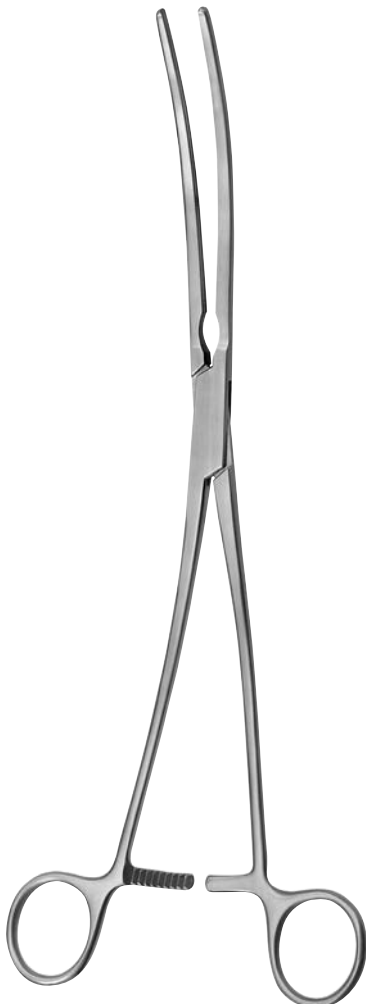

DE BAKEY

15-587-25	25,0 cm, 9 3/4"
15-587-27	27,0 cm, 10 3/4"
15-587-30	30,0 cm, 11 3/4"
15-587-31	31,0 cm, 12 1/4"
15-587-33	33,0 cm, 13"



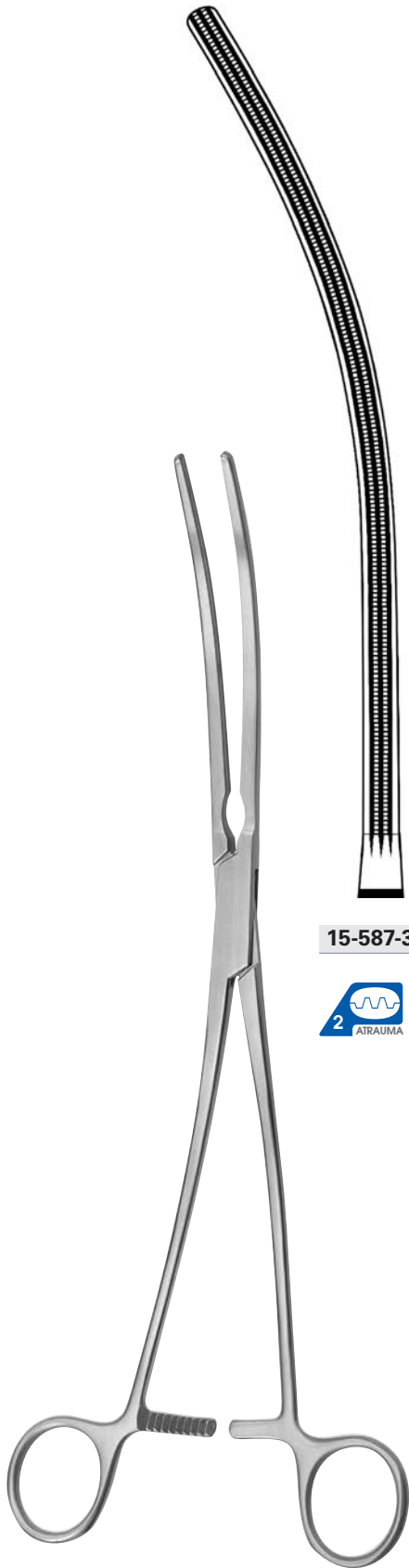

15-587-34



DE BAKEY

15-587-34 33,0 cm, 13 "

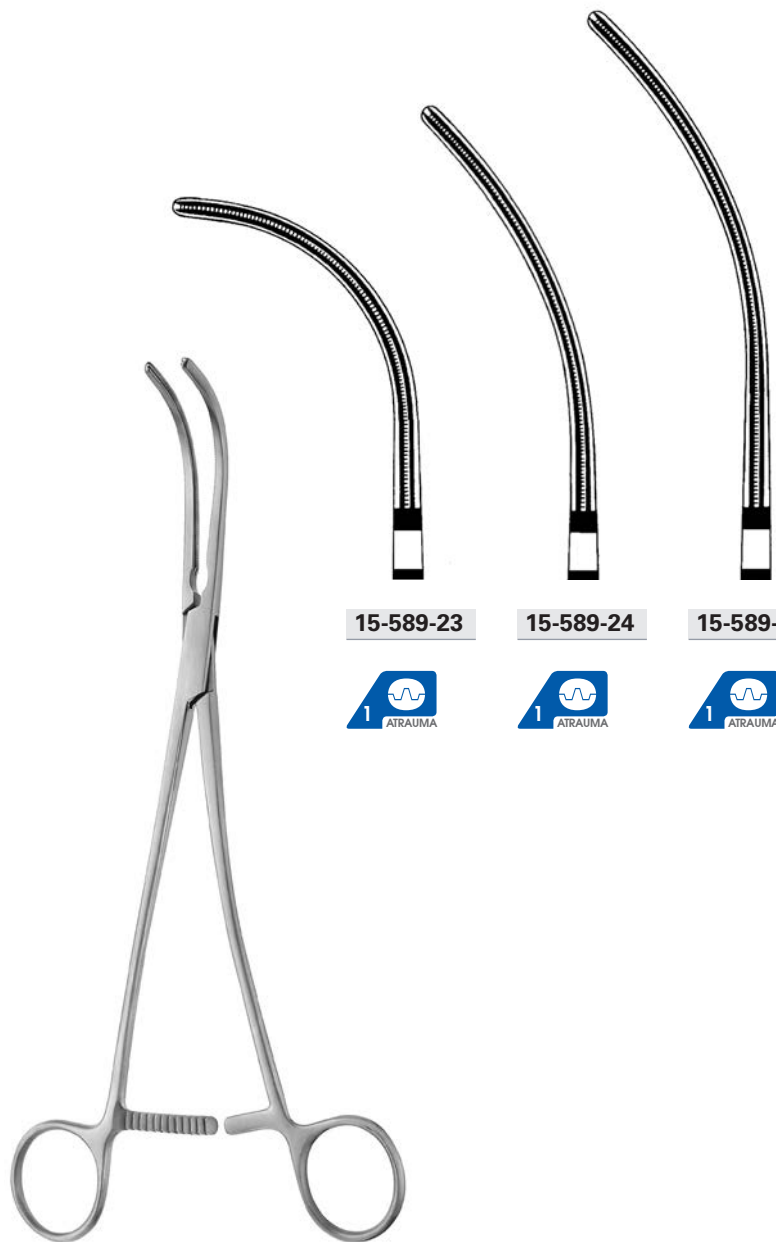

15-589-23



15-589-24



15-589-25



DE BAKEY-BAHNSON

15-589-23 23,5 cm, 9 1/4 "
15-589-24 24,5 cm, 9 2/3 "
15-589-25 25,5 cm, 10 "

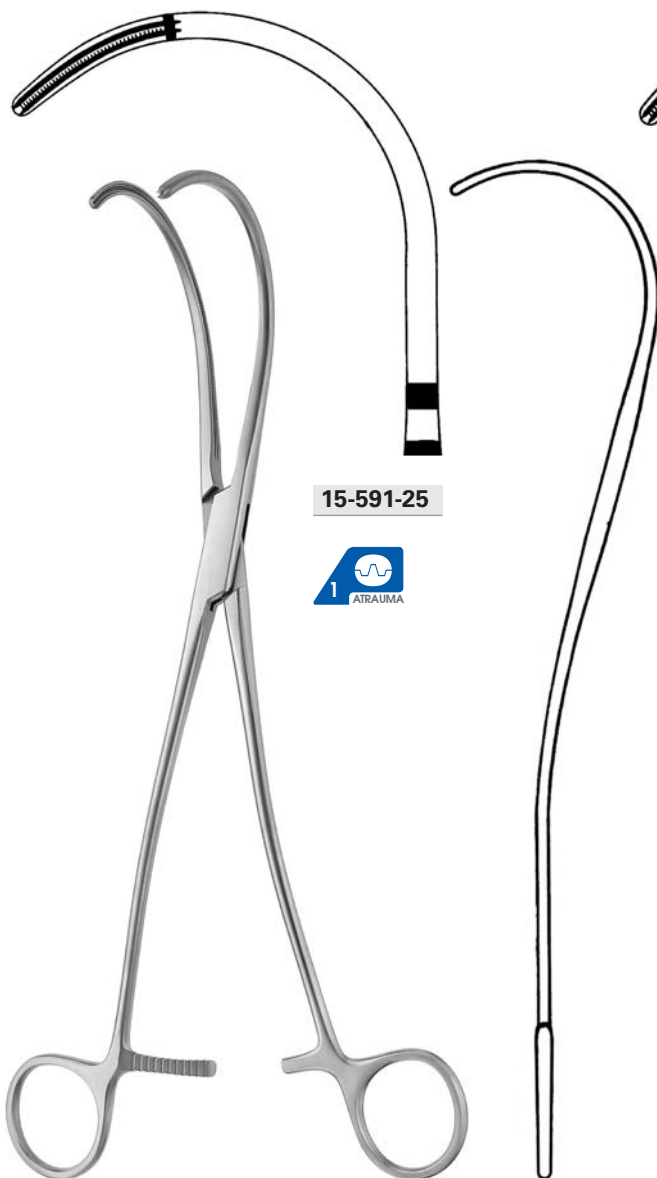

15-591-25

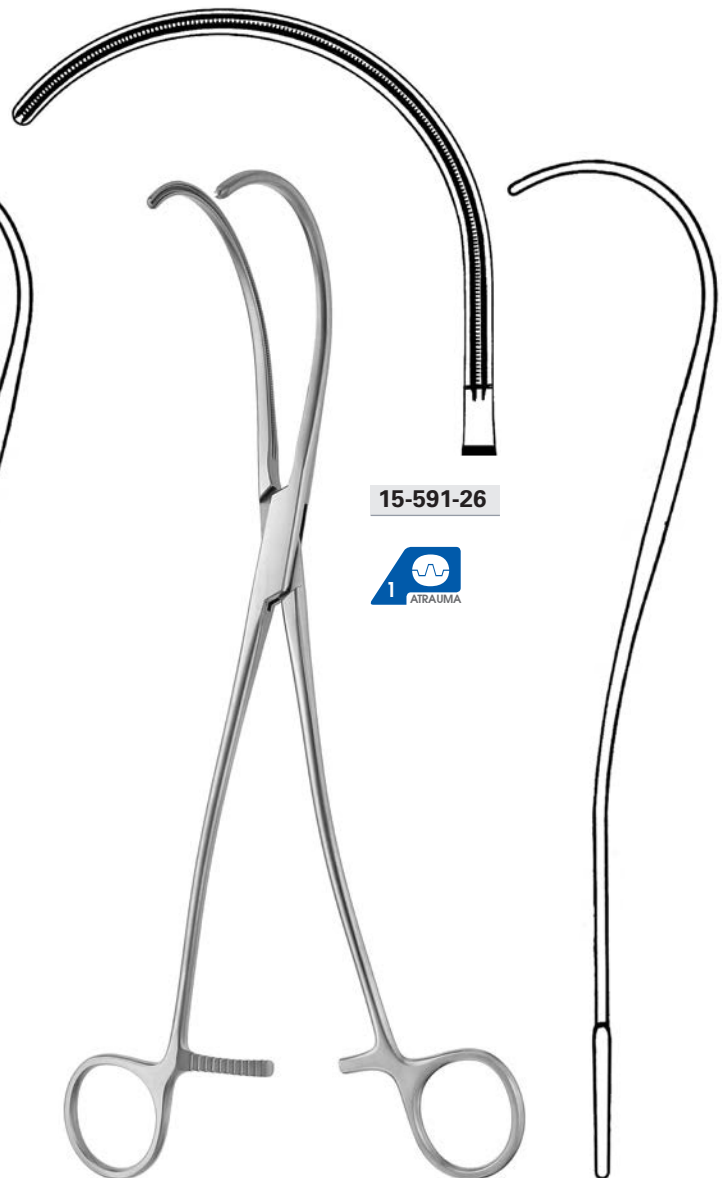

15-591-26



DE BAKEY

15-591-25 27,0 cm, 10 3/4"

DE BAKEY

15-591-26 27,0 cm, 10 3/4"

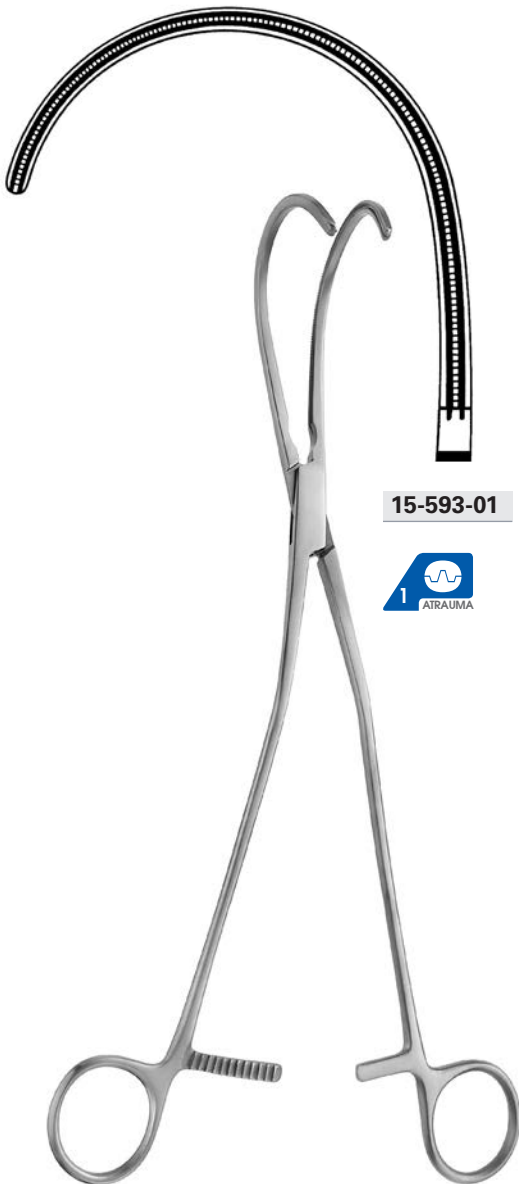

15-593-01



WEBER

15-593-01 26,0 cm, 10 ¼"

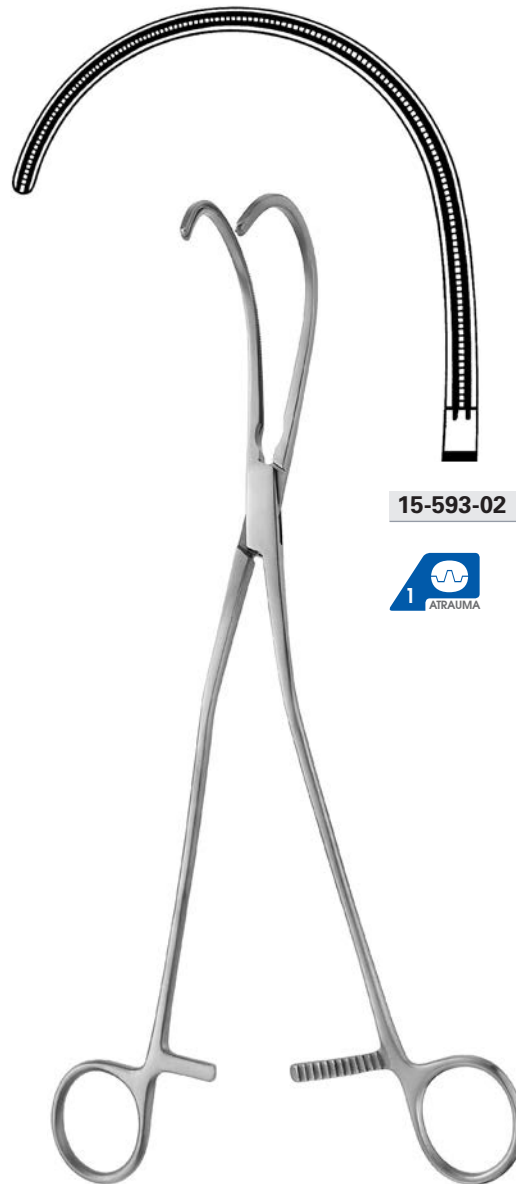

15-593-02



WEBER

15-593-02 26,0 cm, 10 ¼"



15-595-28



DE BAKEY

15-595-28 28,0 cm, 11 "

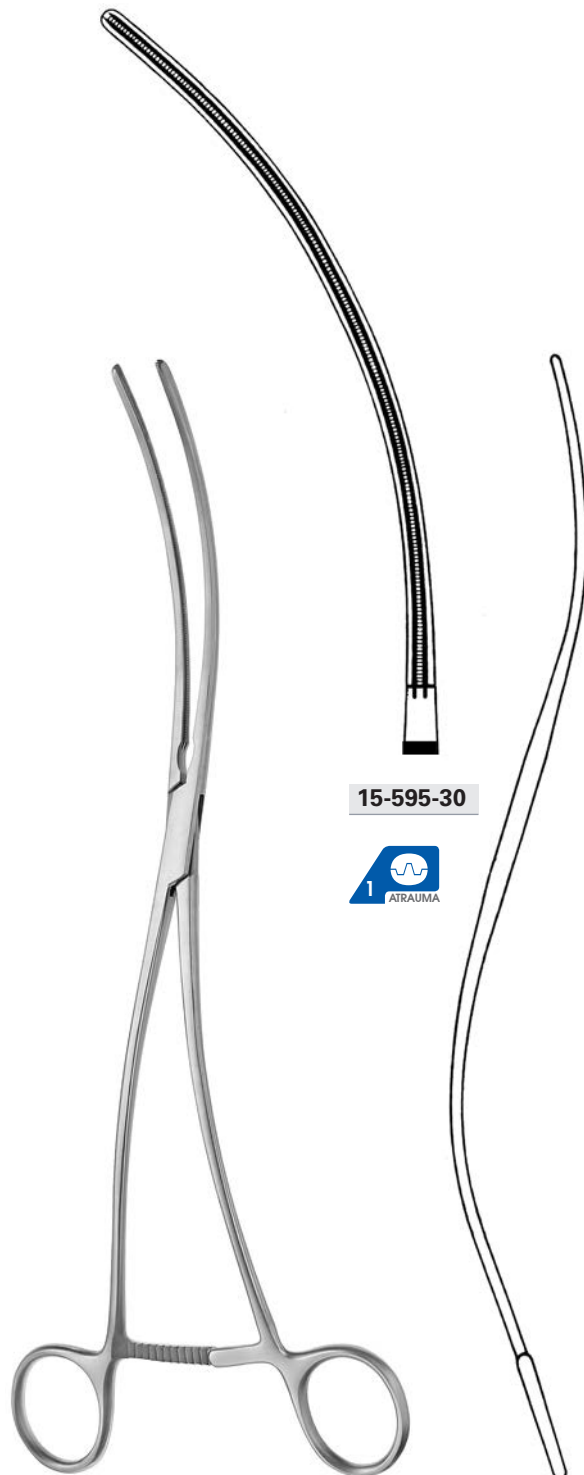

15-595-30



DE BAKEY

15-595-30 30,0 cm, 11 3/4 "



15-596-15



15-596-18



15-597-15



15-597-18



BAINBRIDGE

15-596-15 - 15-597-15 15,0 cm, 6"

15-596-18 - 15-597-18 18,5 cm, 7 1/4"

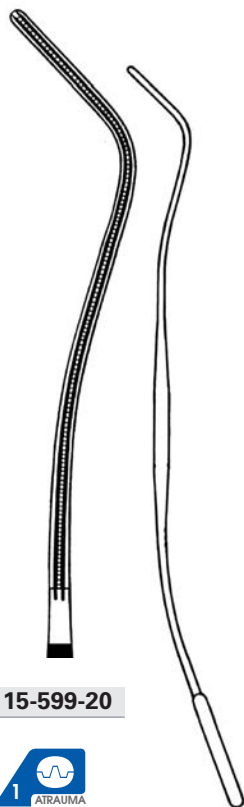

15-599-20

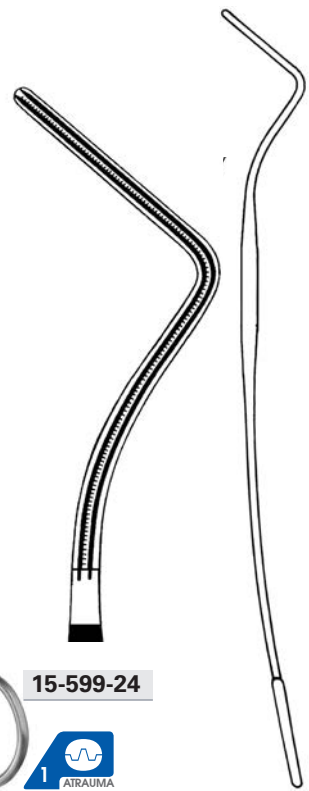

15-599-24



DE BAKEY

15-599-20 20,0 cm, 8"

LEES

15-599-24 24,0 cm, 9 1/2"



15-601-22



POTTS

15-601-22 21,5 cm, 8 ½ "

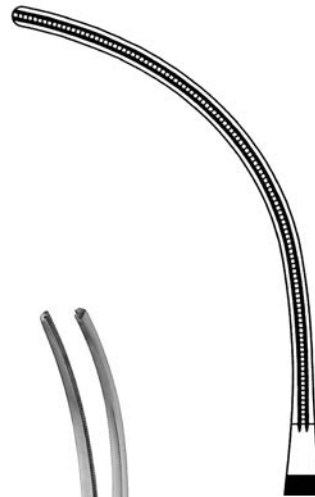

15-601-24



GLOVER

15-601-24 24,5 cm, 9 ⅔ "

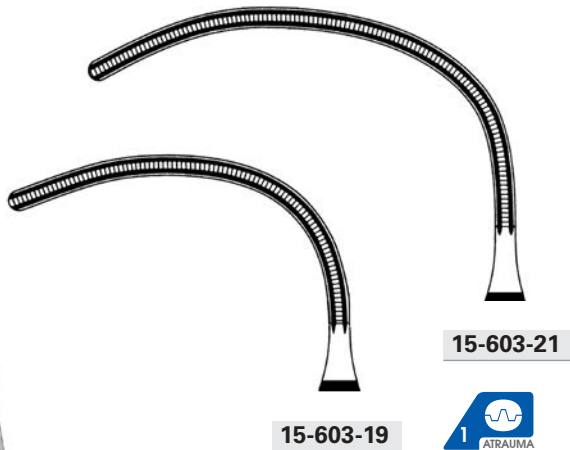

15-603-19

15-603-21



15-603-22



GLOVER

15-603-19	19,5 cm, 7 3/4"
15-603-21	21,0 cm, 8 1/4"

GLOVER

15-603-22	22,0 cm, 8 3/4"
-----------	-----------------

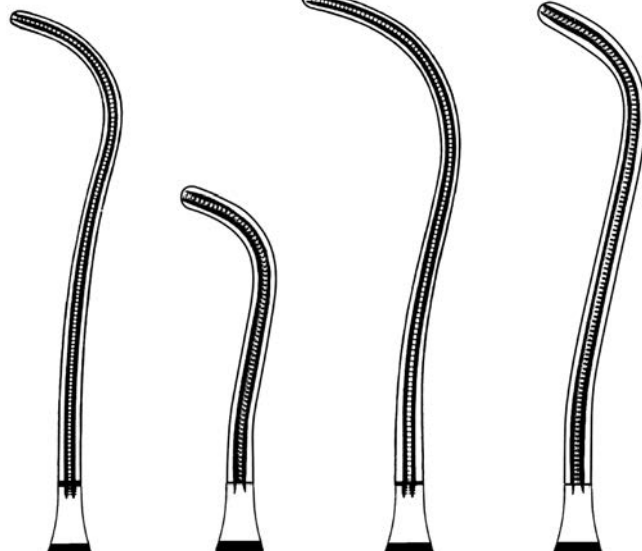

15-605-19

15-605-21

15-605-23

15-605-24



DE BAKEY

15-605-19	19,0 cm, 7 1/2"
15-605-21	21,0 cm, 8 1/4"
15-605-23 - 15-605-24	23,0 cm, 9"



15-607-16



DE BAKEY

15-607-16 16,0 cm, 6 ¼"

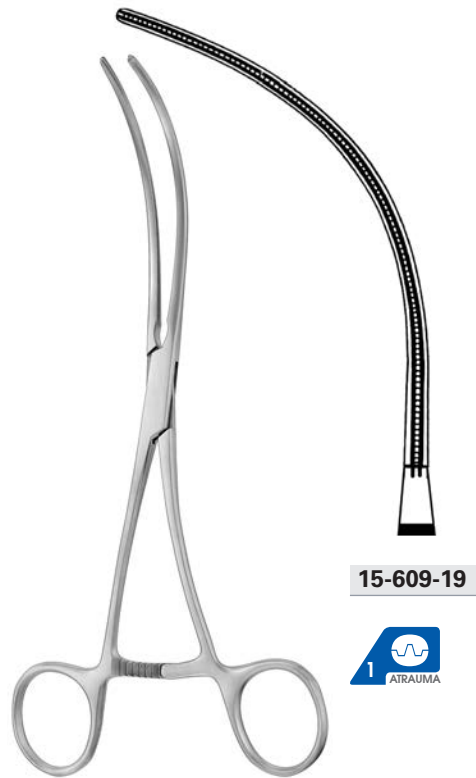

15-609-19



DE BAKEY

15-609-19 19,0 cm, 7 ½"

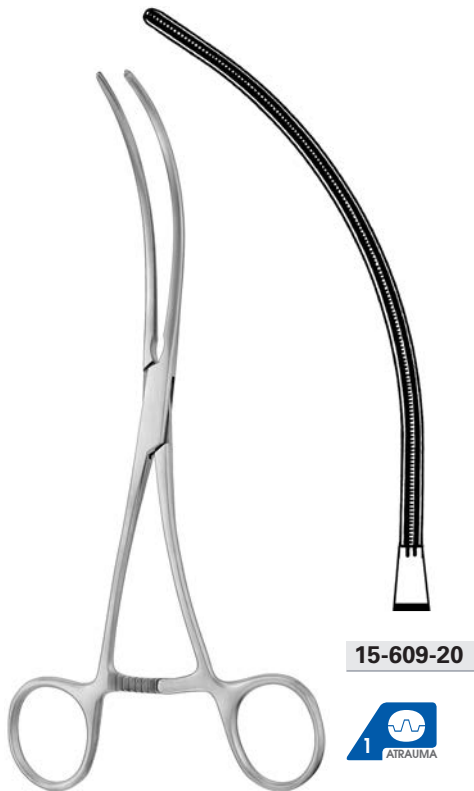

15-609-20



DE BAKEY

15-609-20 19,5 cm, 7 ¾"



15-610-19



LELAND-JONES

15-610-19 19,0 cm, 7 ½"

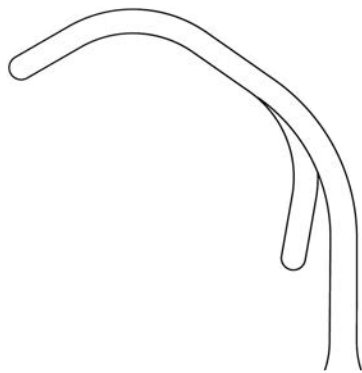
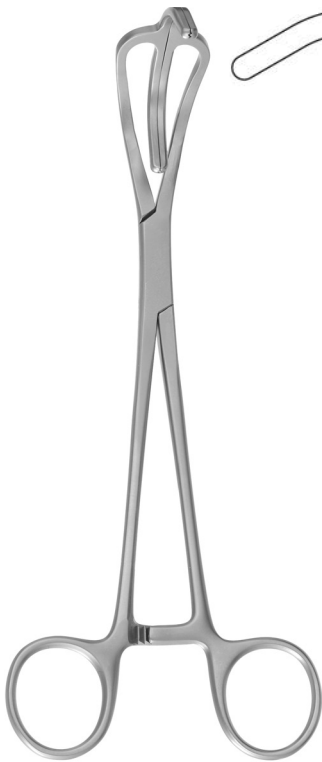

15-610-41	41 x 16 mm
15-610-45	45 x 23 mm

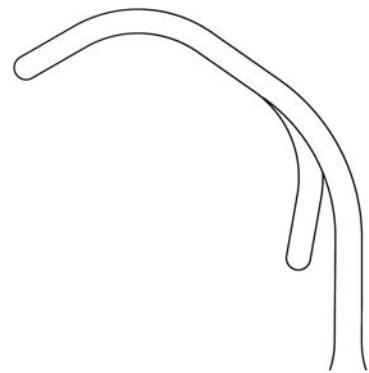

15-611-41	41 x 16 mm
15-611-45	45 x 23 mm



STRONG (COBRA)

15-610-41 - 15-610-45 20,0 cm, 8 "

STRONG (COBRA)

15-611-41 - 15-611-45 17,5 cm, 7 "

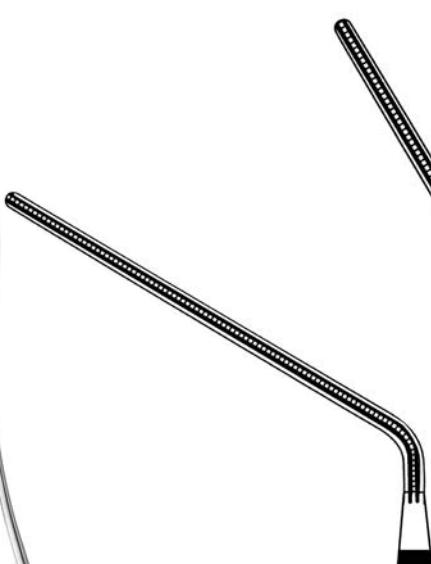

15-611-18



15-611-19

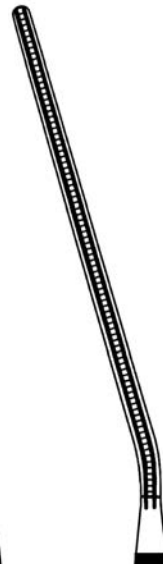

15-611-20



LELAND-JONES

15-611-18	18,0 cm, 7 "
15-611-19	18,5 cm, 7 ¼ "
15-611-20	19,5 cm, 7 ¾ "

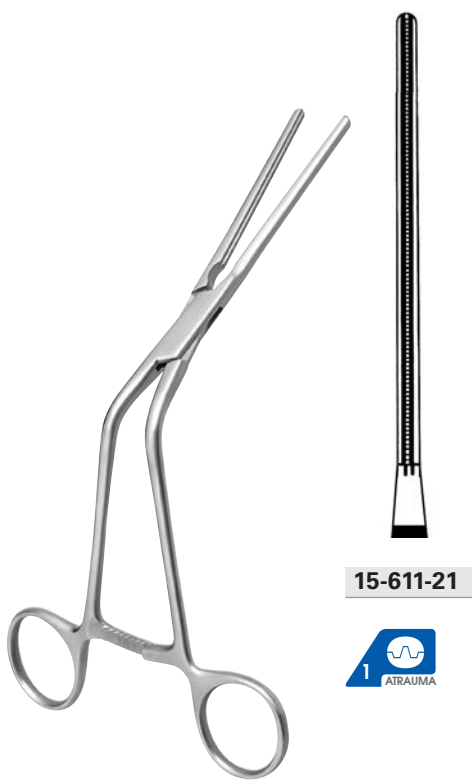

LELAND-JONES

15-611-21 20,0 cm, 8 "

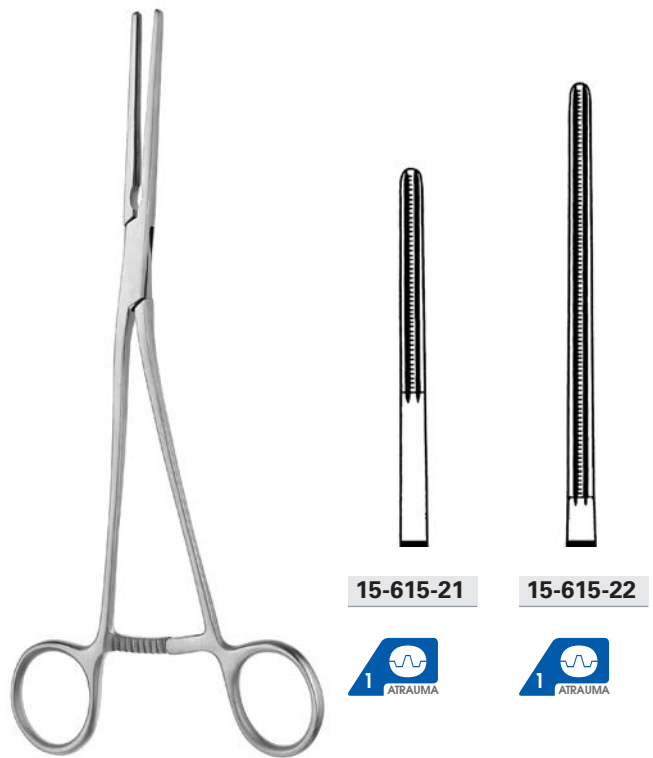

POTTS

15-615-21 21,0 cm, 8 ¼ "

15-615-22 22,0 cm, 8 ¾ "

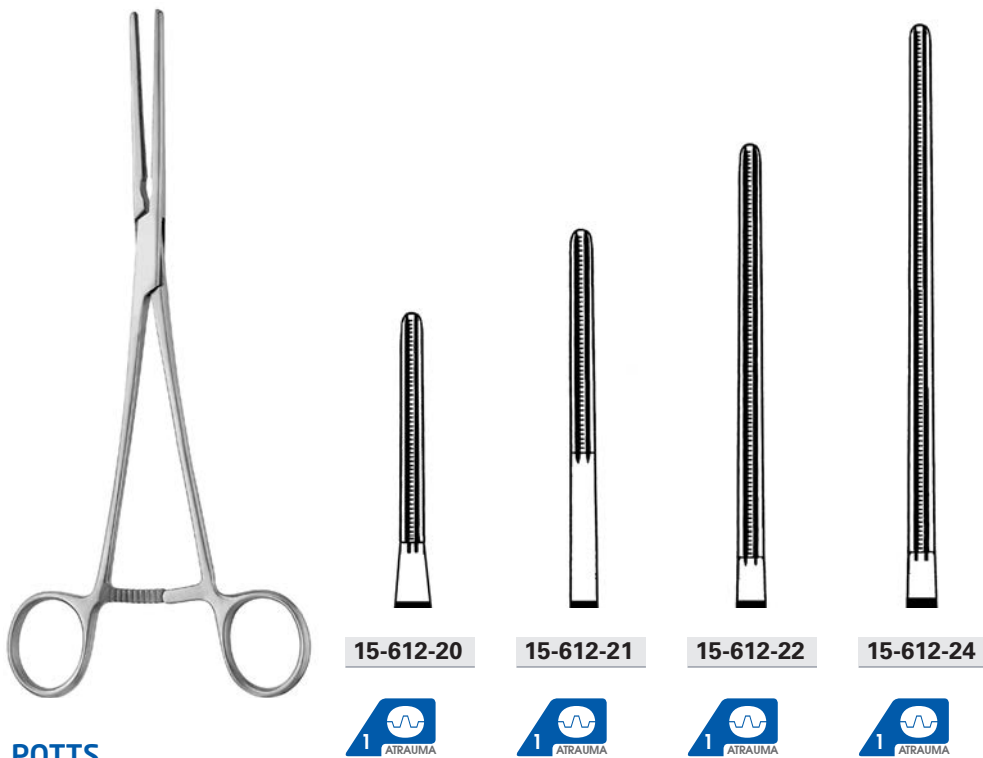

POTTS

15-612-20 20,5 cm, 8 "

15-612-21 21,0 cm, 8 ¼ "

15-612-22 22,5 cm, 9 "

15-612-24 24,0 cm, 9 ½ "

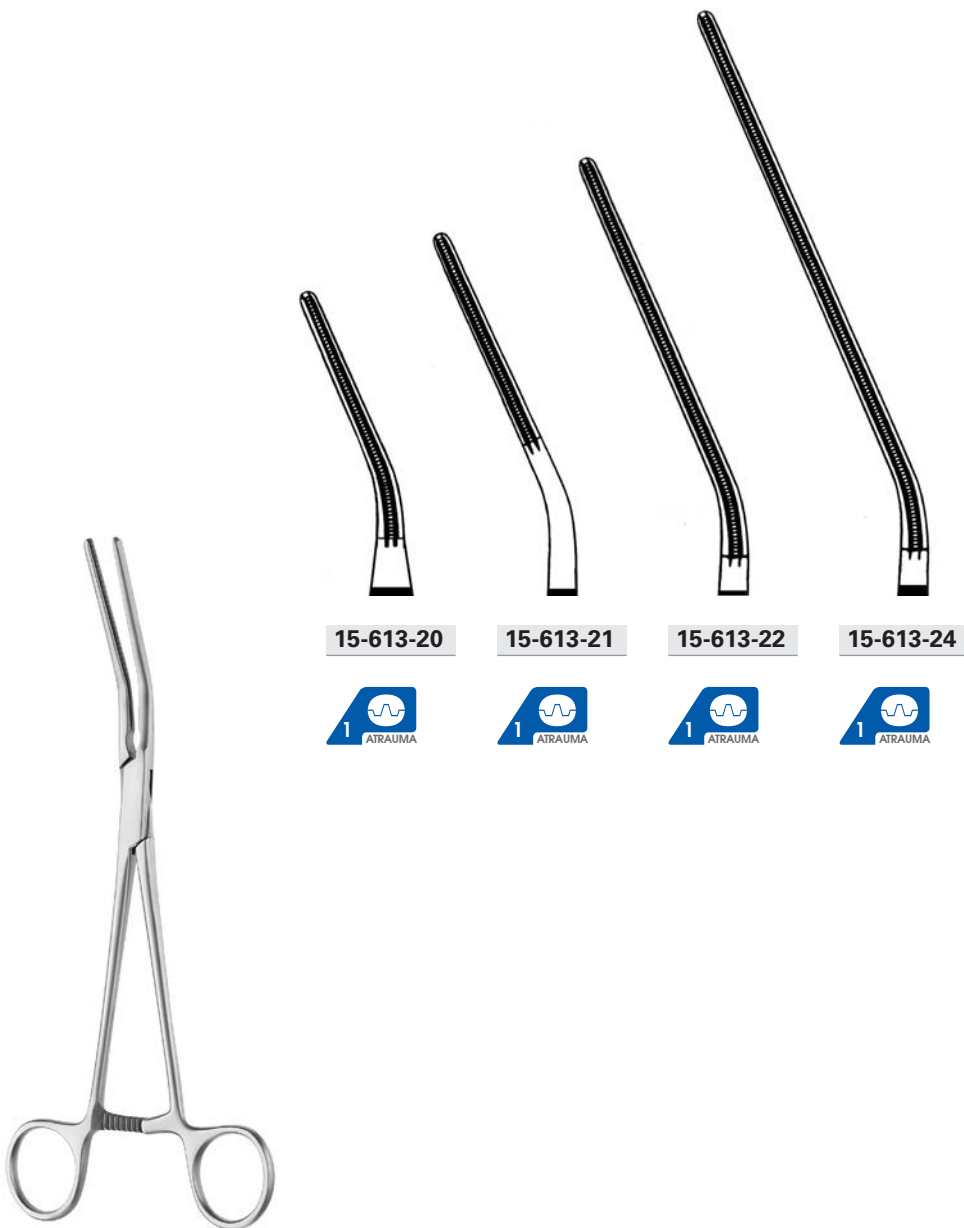

POTTS

15-613-20	20,0 cm, 8 "
15-613-21	20,5 cm, 8 "
15-613-22	22,0 cm, 8 ¾ "
15-613-24	24,0 cm, 9 ½ "

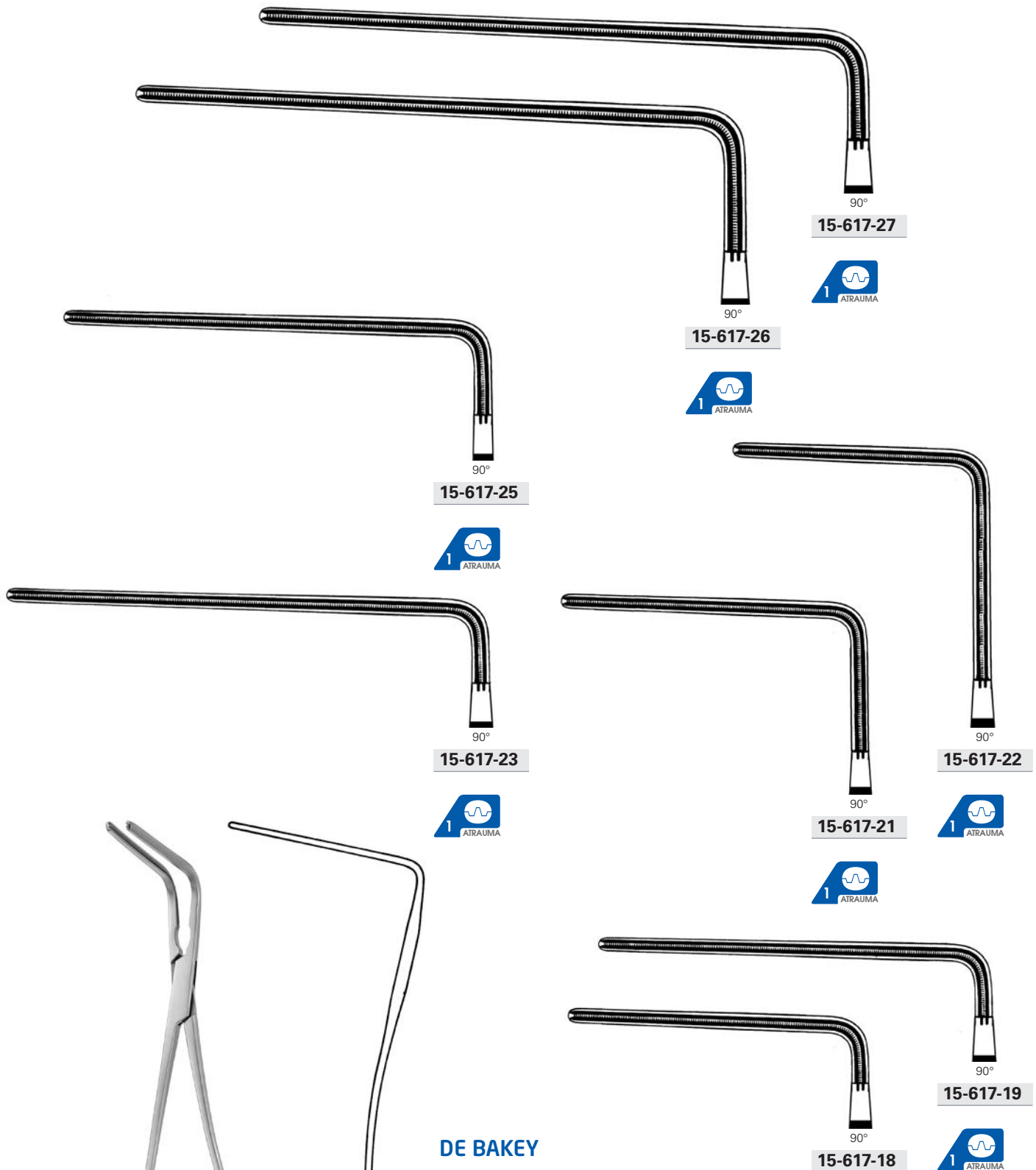

DE BAKAY

15-617-18	18,0 cm, 7 "
15-617-19	18,5 cm, 7 ¼ "
15-617-21	21,0 cm, 8 ¼ "
15-617-22	22,5 cm, 9 "
15-617-23	21,5 cm, 8 ½ "
15-617-25	25,5 cm, 10 "
15-617-26	25,5 cm, 10 "
15-617-27	27,5 cm, 10 ¾ "

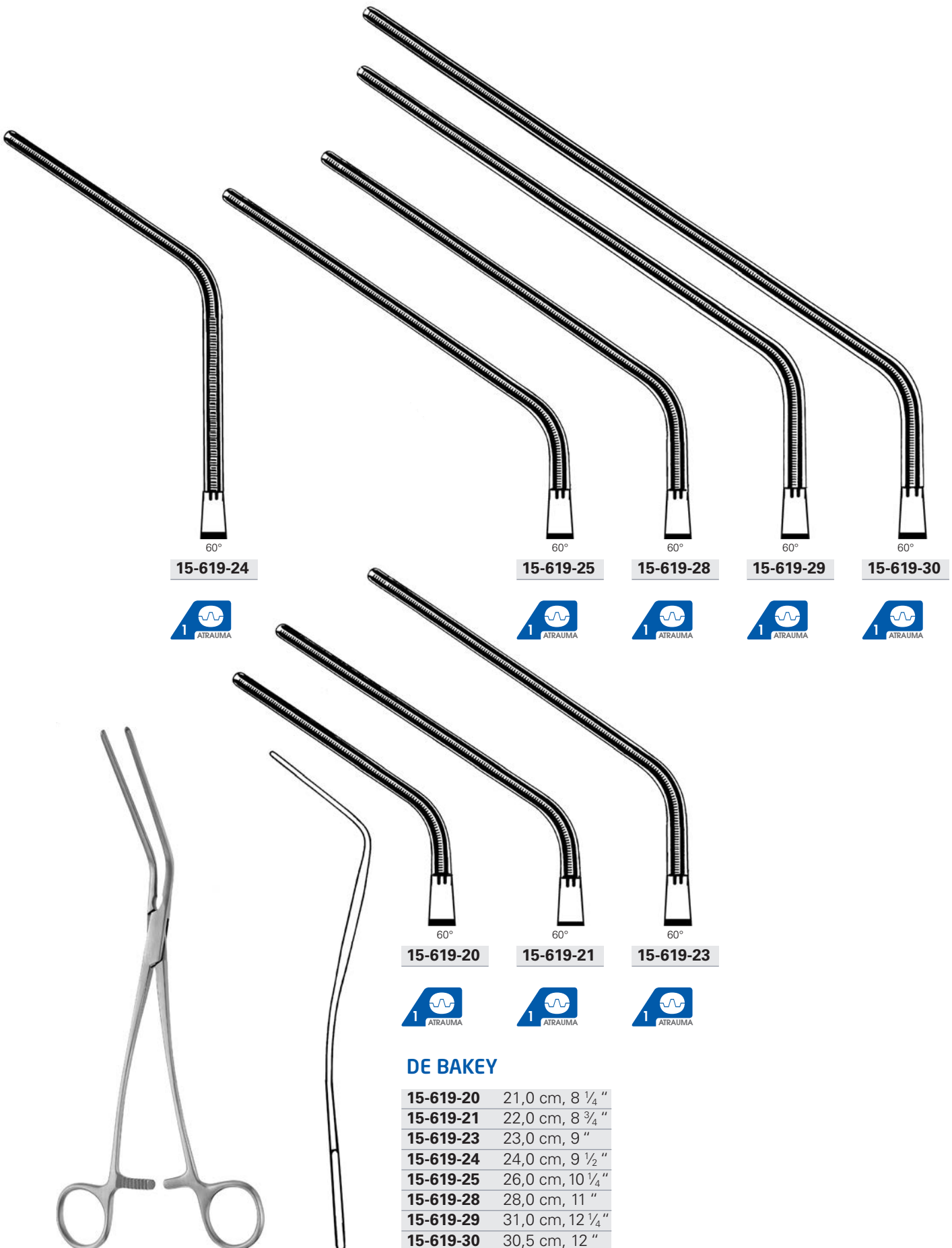

DE BAKHEY

15-619-20	21,0 cm, 8 ¼ "
15-619-21	22,0 cm, 8 ¾ "
15-619-23	23,0 cm, 9 "
15-619-24	24,0 cm, 9 ½ "
15-619-25	26,0 cm, 10 ¼ "
15-619-28	28,0 cm, 11 "
15-619-29	31,0 cm, 12 ¼ "
15-619-30	30,5 cm, 12 "

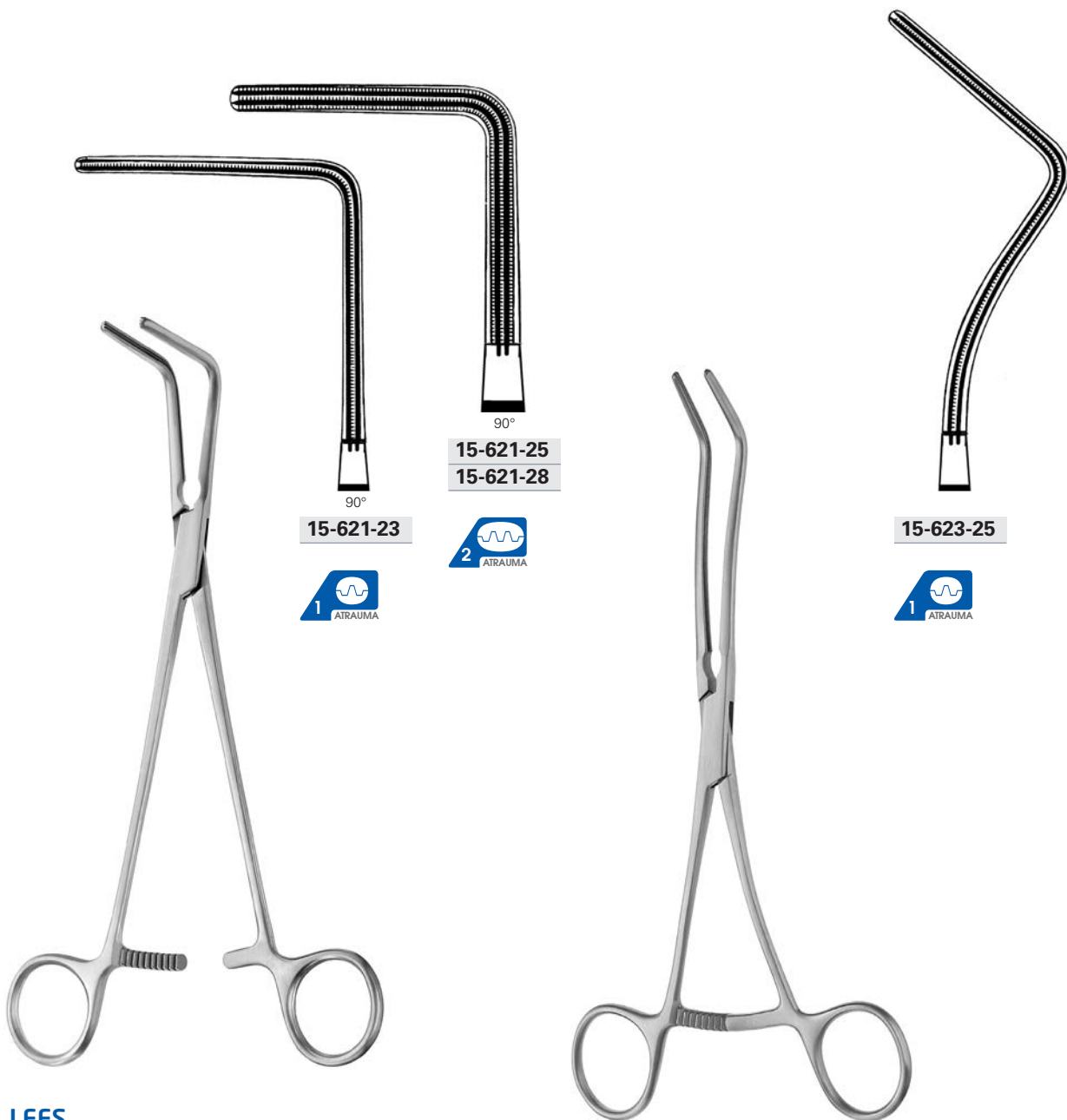

LEES

15-621-23	23,0 cm, 9 "
15-621-25	25,5 cm, 10 "
15-621-28	28,0 cm, 11 "

LEES

15-623-25	25,0 cm, 9 3/4 "
------------------	------------------

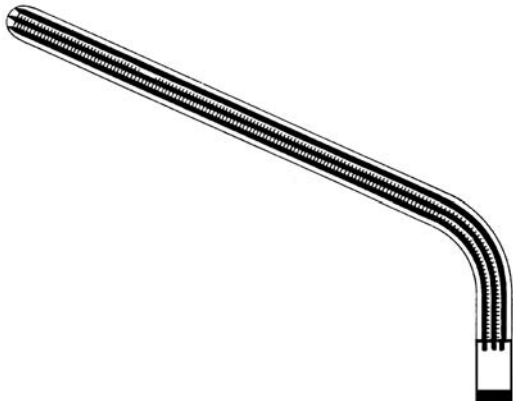

15-625-05

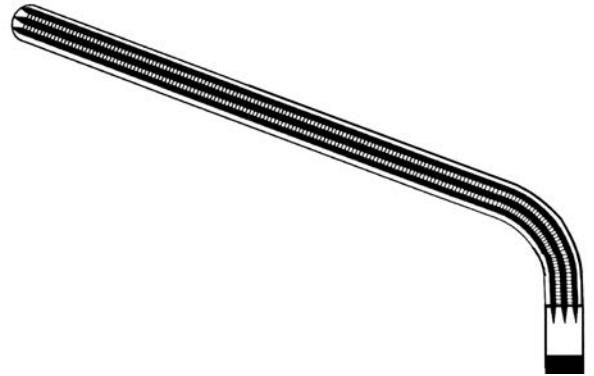

15-625-06

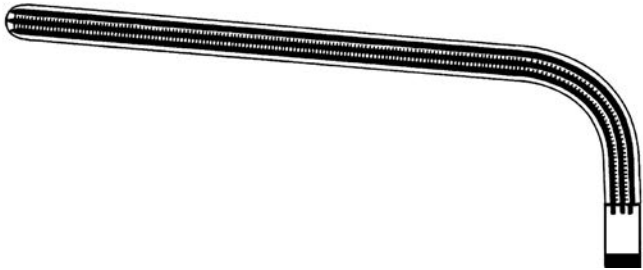

15-625-03

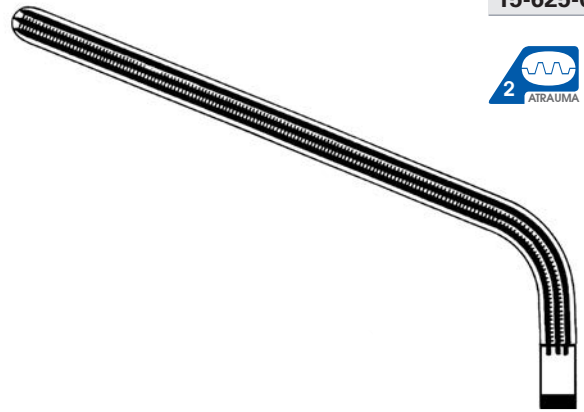

15-625-04

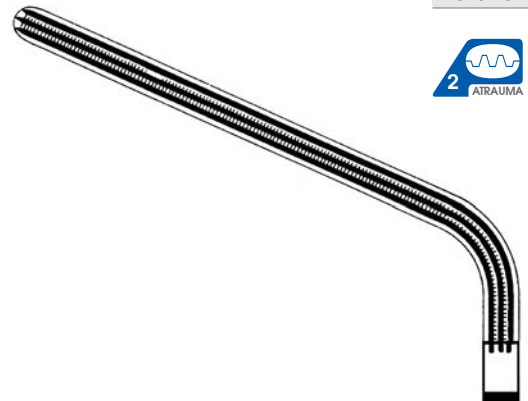

15-625-02

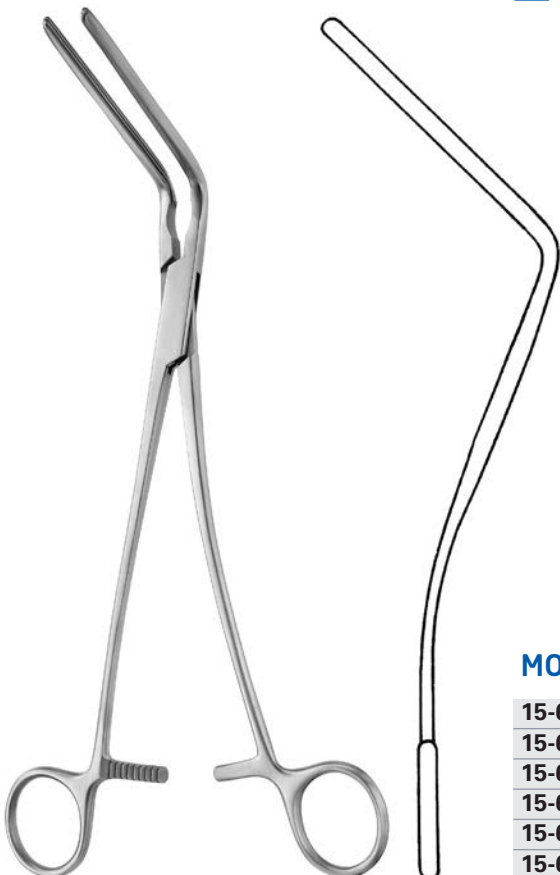

MORRIS-DE BAKEY

15-625-01	16,5 cm, 6 1/2 "
15-625-02	20,0 cm, 8 "
15-625-03	24,0 cm, 9 1/2 "
15-625-04	26,0 cm, 10 1/4 "
15-625-05	17,5 cm, 7 "
15-625-06	24,0 cm, 9 1/2 "

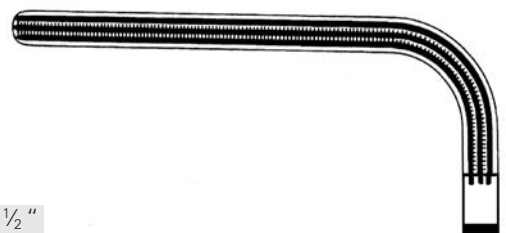

15-625-01





15-627-27



15-629-24

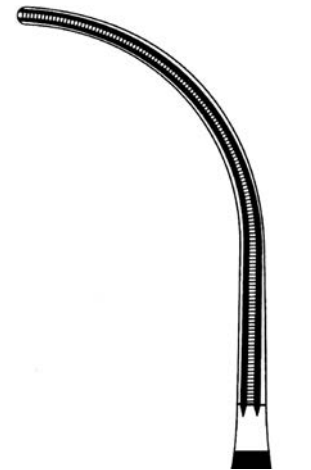

15-631-24



DE BAKEY

15-627-27 27,0 cm, 10 3/4"

DE BAKEY

15-629-24 24,0 cm, 9 1/2"
 15-631-24 24,5 cm, 9 2/3"



15-633-14



15-633-16



15-633-18



GREGORY

15-633-14	13,0 cm, 5 1/8"
15-633-16	16,0 cm, 6 1/4"
15-633-18	18,0 cm, 7"

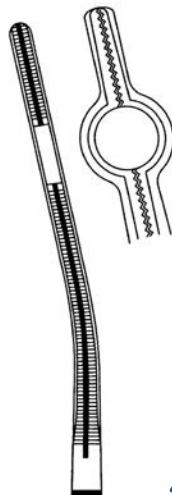

15-634-01	24 Charr.
15-634-02	26 Charr.
15-634-03	28 Charr.
15-634-04	30 Charr.
15-634-05	32 Charr.
15-634-07	36 Charr.

COOLEY

15-634-01 - 15-634-02	16,0 cm, 6 1/4"
15-634-03 - 15-634-07	20,0 cm, 8"

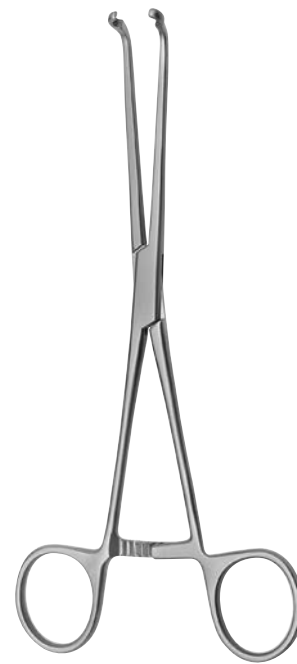

JAVID

15-635-16	17,5 cm, 7"
-----------	-------------



JAVID

15-635-19 18,0 cm, 7 "



HUSFELDT

15-636-01 17,5 cm, 7 "



15-636-01



15-636-02



HUSFELDT

15-636-02 18,0 cm, 7 "



15-636-03



HUSFELDT

15-636-03 17,0 cm, 6 3/4 "

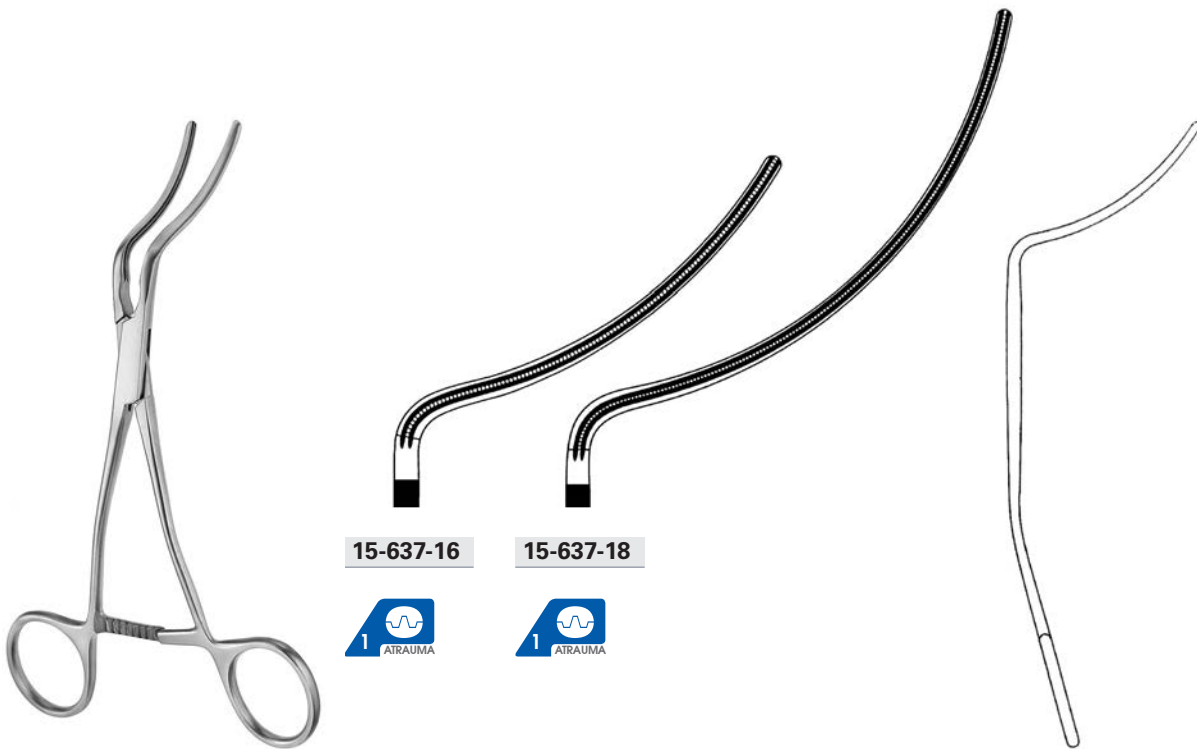

DE BAKEY

15-637-16	16,0 cm, 6 ¼"
15-637-18	18,0 cm, 7"

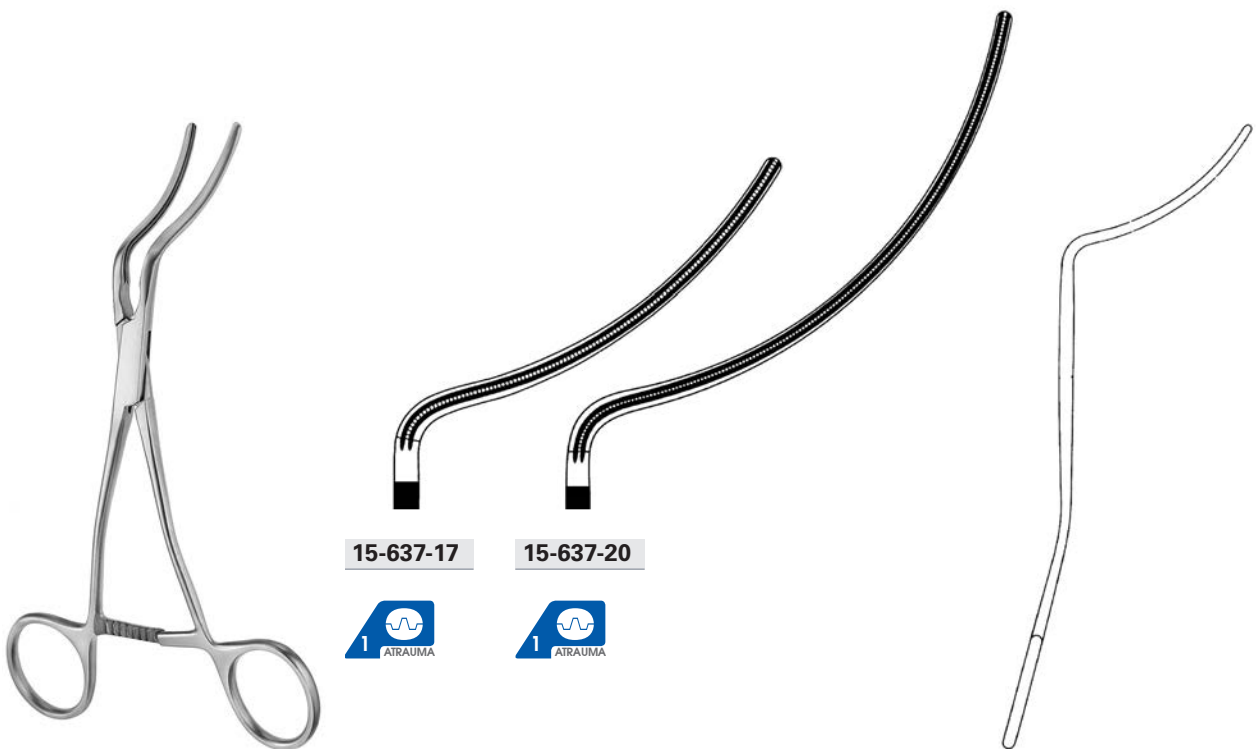

DE BAKEY

15-637-17	16,5 cm, 6 ½"
15-637-20	19,5 cm, 7 ¾"

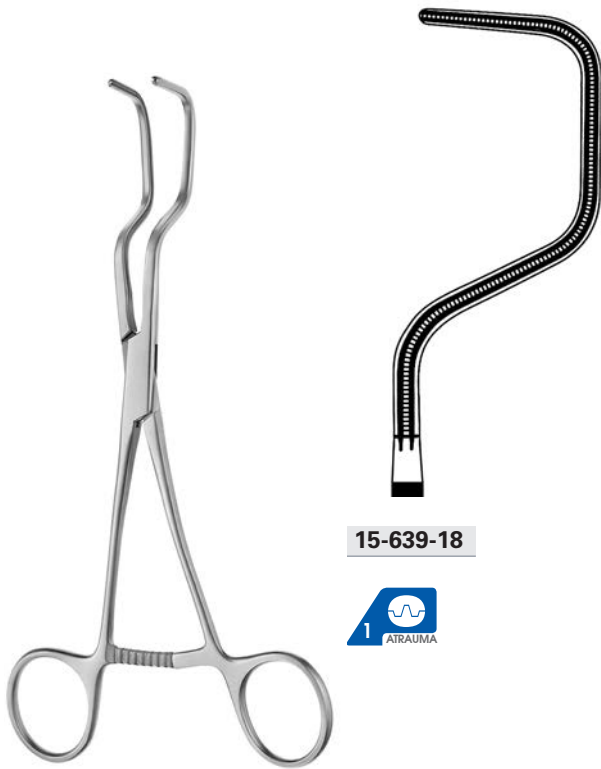

15-639-18



DALE

15-639-18 18,0 cm, 7 "

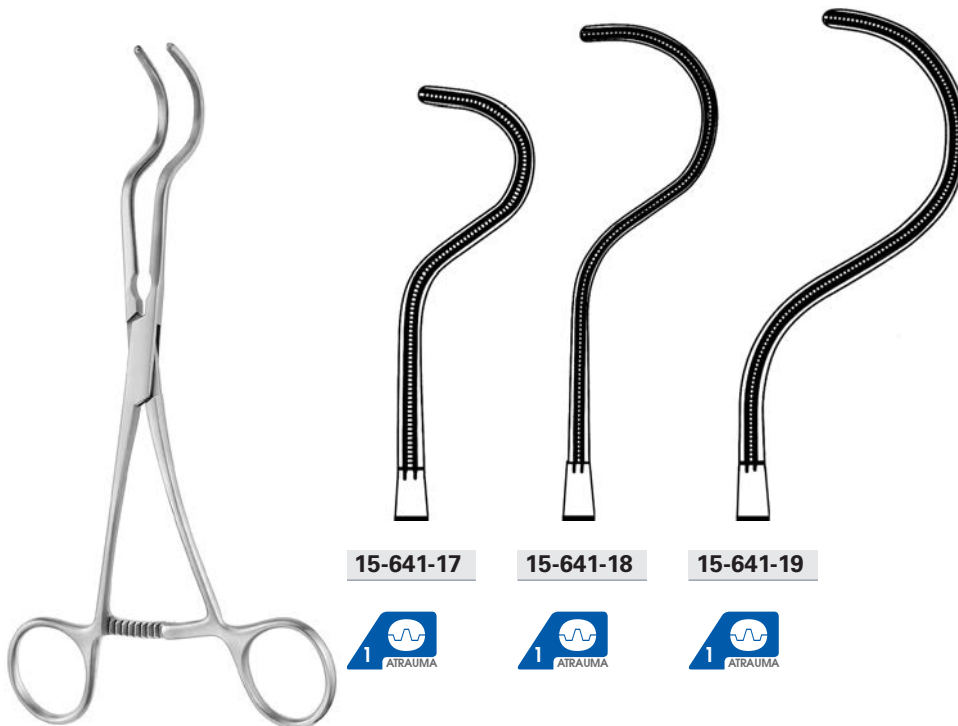

15-641-17

15-641-18

15-641-19



DALE

15-641-17 17,5 cm, 7 "

15-641-18 18,0 cm, 7 "

15-641-19 19,5 cm, 7 3/4 "



15-643-21
15-643-25



15-643-22



LAMBERT-KAY

15-643-21	21,5 cm, 8 1/2"
15-643-22	22,0 cm, 8 3/4"
15-643-25	25,5 cm, 10"



15-645-17

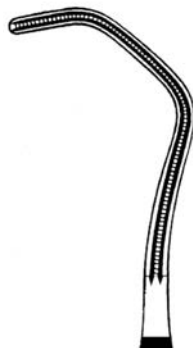

15-645-20

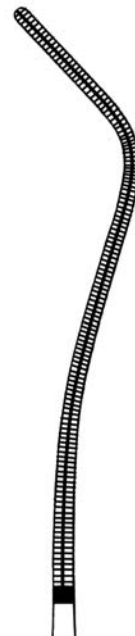

DE BAKEY

15-645-17	16,5 cm, 6 1/2"
-----------	-----------------

COOLEY

15-645-20	20,0 cm, 8"
-----------	-------------

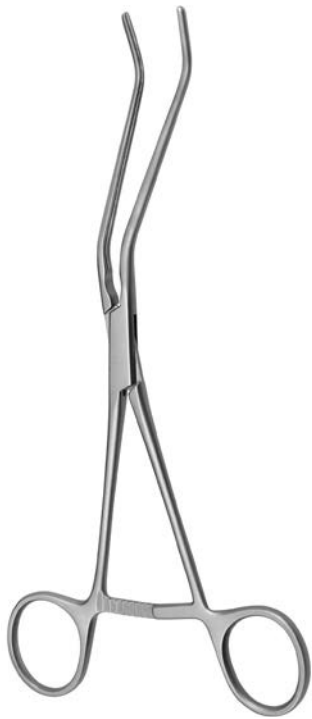

15-646-19



HENLEY

15-646-19 19,5 cm, 7 3/4"



15-649-23



OCHSNER

15-649-23 23,5 cm, 9 1/4"



15-647-01

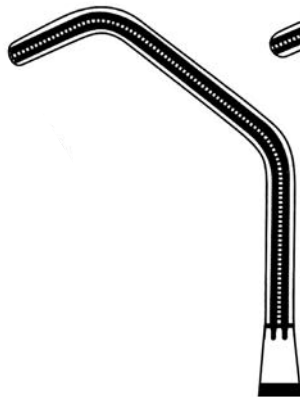

15-647-02

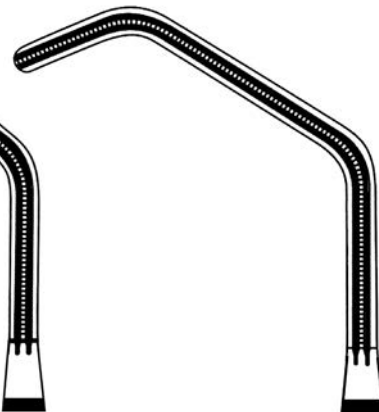

15-647-03



DE BAKEY-SATINSKY

15-647-01 23,5 cm, 9 1/4"
 15-647-02 24,0 cm, 9 1/2"
 15-647-03 24,5 cm, 9 2/3"



15-647-26



1 ATRAUMA

1 ATRAUMA

1 ATRAUMA

1 ATRAUMA

1 ATRAUMA

1 ATRAUMA

1 ATRAUMA

1 ATRAUMA

1 ATRAUMA

1 ATRAUMA

1 ATRAUMA

1 ATRAUMA

1 ATRAUMA

1 ATRAUMA

1 ATRAUMA

1 ATRAUMA

1 ATRAUMA

1 ATRAUMA

1 ATRAUMA

1 ATRAUMA

1 ATRAUMA

1 ATRAUMA

1 ATRAUMA

1 ATRAUMA

1 ATRAUMA

1 ATRAUMA

1 ATRAUMA

1 ATRAUMA

1 ATRAUMA

1 ATRAUMA

1 ATRAUMA

1 ATRAUMA

1 ATRAUMA

1 ATRAUMA

1 ATRAUMA

1 ATRAUMA

1 ATRAUMA

1 ATRAUMA

1 ATRAUMA

1 ATRAUMA

1 ATRAUMA

1 ATRAUMA

1 ATRAUMA

1 ATRAUMA

1 ATRAUMA

1 ATRAUMA

1 ATRAUMA

1 ATRAUMA

1 ATRAUMA

1 ATRAUMA

1 ATRAUMA

1 ATRAUMA

1 ATRAUMA

1 ATRAUMA

1 ATRAUMA

1 ATRAUMA

1 ATRAUMA

1 ATRAUMA

1 ATRAUMA

1 ATRAUMA

1 ATRAUMA

1 ATRAUMA

1 ATRAUMA

1 ATRAUMA

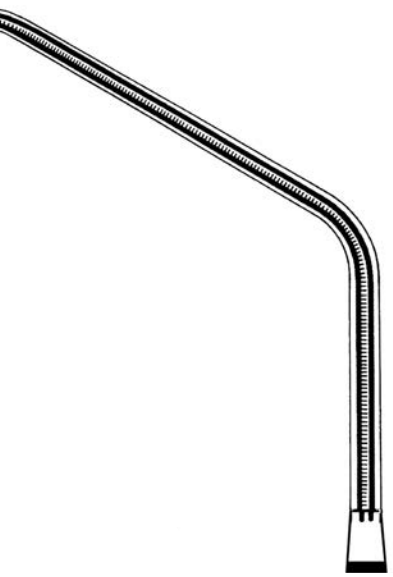

15-647-27



1 ATRAUMA

1 ATRAUMA

1 ATRAUMA

1 ATRAUMA

1 ATRAUMA

1 ATRAUMA

1 ATRAUMA

1 ATRAUMA

1 ATRAUMA

1 ATRAUMA

1 ATRAUMA

1 ATRAUMA

1 ATRAUMA

1 ATRAUMA

1 ATRAUMA

1 ATRAUMA

1 ATRAUMA

1 ATRAUMA

1 ATRAUMA

1 ATRAUMA

1 ATRAUMA

1 ATRAUMA

1 ATRAUMA

1 ATRAUMA

1 ATRAUMA

1 ATRAUMA

1 ATRAUMA

1 ATRAUMA

1 ATRAUMA

1 ATRAUMA

1 ATRAUMA

1 ATRAUMA

1 ATRAUMA

1 ATRAUMA

1 ATRAUMA

1 ATRAUMA

1 ATRAUMA

1 ATRAUMA

1 ATRAUMA

1 ATRAUMA

1 ATRAUMA

1 ATRAUMA

1 ATRAUMA

1 ATRAUMA

1 ATRAUMA

1 ATRAUMA

1 ATRAUMA

1 ATRAUMA

1 ATRAUMA

1 ATRAUMA

1 ATRAUMA

1 ATRAUMA

1 ATRAUMA

1 ATRAUMA

1 ATRAUMA

1 ATRAUMA

1 ATRAUMA

1 ATRAUMA

1 ATRAUMA

1 ATRAUMA

1 ATRAUMA

1 ATRAUMA

1 ATRAUMA

1 ATRAUMA



15-647-25



1 ATRAUMA

1 ATRAUMA

1 ATRAUMA

1 ATRAUMA

1 ATRAUMA

1 ATRAUMA

1 ATRAUMA

1 ATRAUMA

1 ATRAUMA

1 ATRAUMA

1 ATRAUMA

1 ATRAUMA

1 ATRAUMA

1 ATRAUMA

1 ATRAUMA

1 ATRAUMA

1 ATRAUMA

1 ATRAUMA

1 ATRAUMA

1 ATRAUMA

1 ATRAUMA

1 ATRAUMA

1 ATRAUMA

1 ATRAUMA

1 ATRAUMA

1 ATRAUMA

1 ATRAUMA

1 ATRAUMA

1 ATRAUMA

1 ATRAUMA

1 ATRAUMA

1 ATRAUMA

1 ATRAUMA

1 ATRAUMA

1 ATRAUMA



15-647-24



1 ATRAUMA

1 ATRAUMA

1 ATRAUMA

1 ATRAUMA

1 ATRAUMA

1 ATRAUMA

1 ATRAUMA

1 ATRAUMA

1 ATRAUMA

1 ATRAUMA

1 ATRAUMA

1 ATRAUMA

1 ATRAUMA

1 ATRAUMA

1 ATRAUMA

1 ATRAUMA

1 ATRAUMA

1 ATRAUMA

1 ATRAUMA

1 ATRAUMA

1 ATRAUMA

1 ATRAUMA

1 ATRAUMA

1 ATRAUMA

1 ATRAUMA

1 ATRAUMA

1 ATRAUMA

1 ATRAUMA

1 ATRAUMA

1 ATRAUMA

1 ATRAUMA

1 ATRAUMA

1 ATRAUMA

1 ATRAUMA

1 ATRAUMA



15-647-20



1 ATRAUMA

1 ATRAUMA

1 ATRAUMA

1 ATRAUMA

1 ATRAUMA

1 ATRAUMA

1 ATRAUMA



SATINSKY

15-647-20	22,0 cm, 8 3/4"
15-647-24	26,0 cm, 10 1/4"
15-647-25	26,5 cm, 10 1/2"
15-647-26	27,5 cm, 10 3/4"
15-647-27	28,5 cm, 11 1/4"



15-650-01

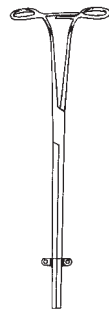

T - ATRAUMA

15-650-01 29,0 cm, 11 1/2"

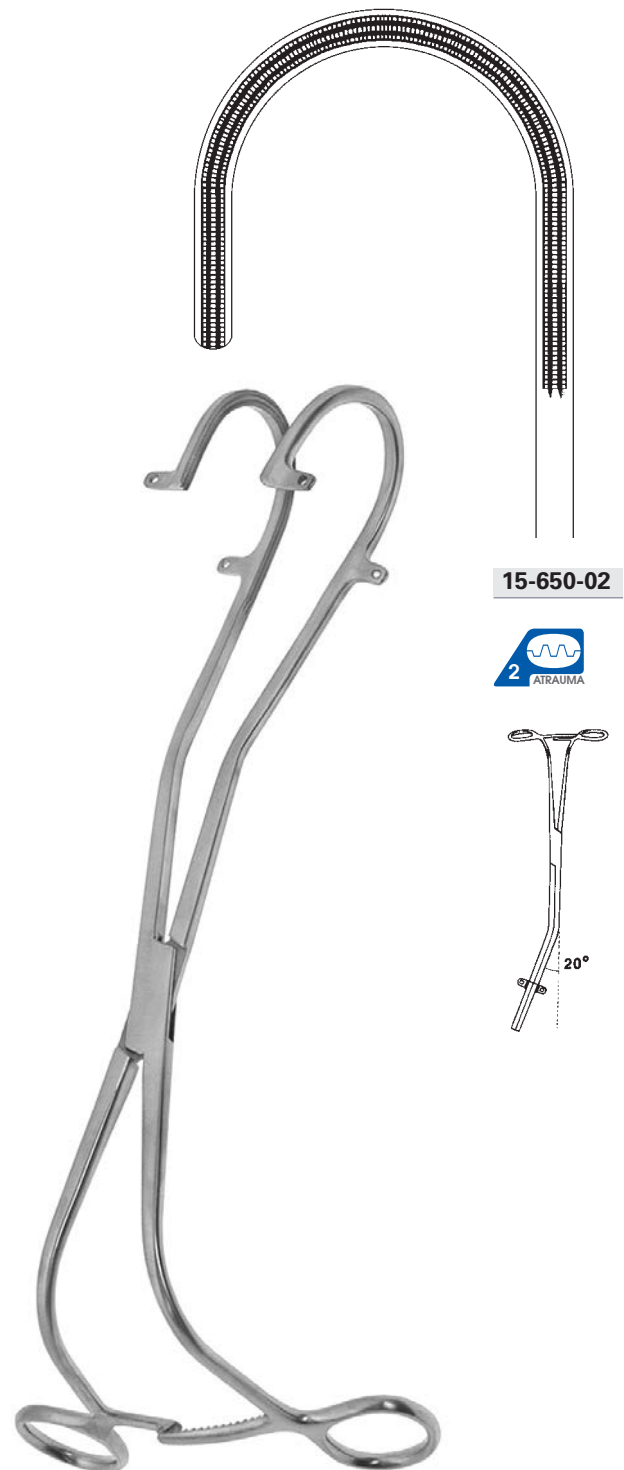

15-650-02

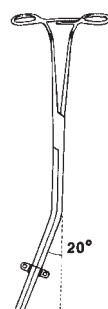

T - ATRAUMA

15-650-02 29,0 cm, 11 1/2"

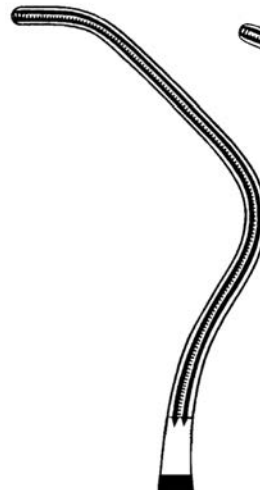

15-653-03

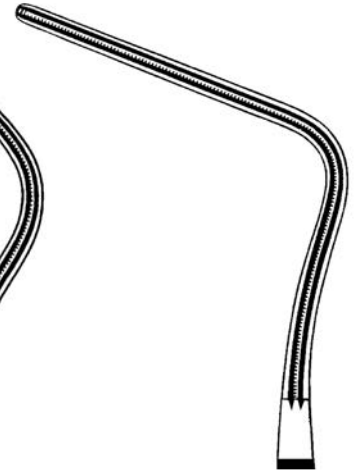

15-653-04



15-651-21



DIÉTRICH

15-651-21 22,0 cm, 8 3/4"



HARKEN

15-653-01	24,5 cm, 9 2/3"
15-653-02	24,5 cm, 9 2/3"
15-653-03	23,0 cm, 9"
15-653-04	23,5 cm, 9 1/4"



15-653-01

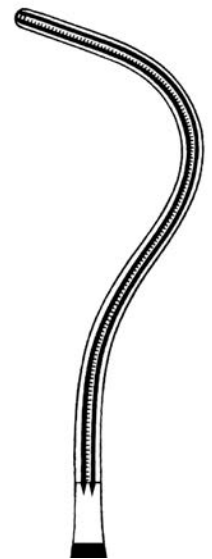

15-653-02



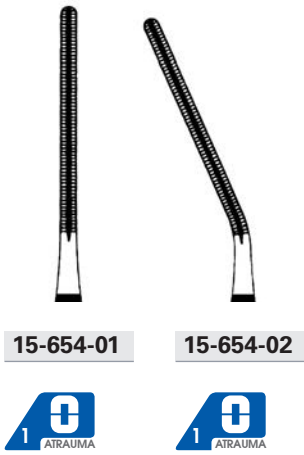

COOLEY

15-654-01 - 15-654-02 14,5 cm, 5 3/4"

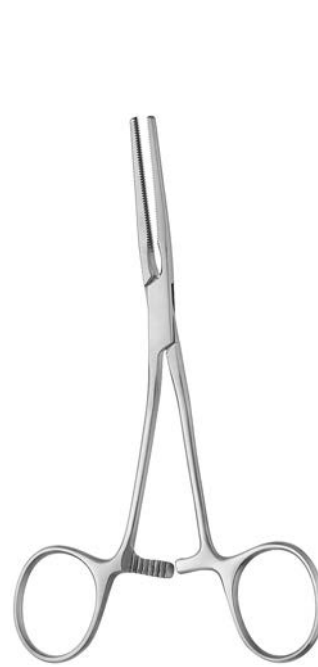

COOLEY

15-654-03 14,0 cm, 5 1/2"



COOLEY

15-654-04 14,0 cm, 5 1/2"

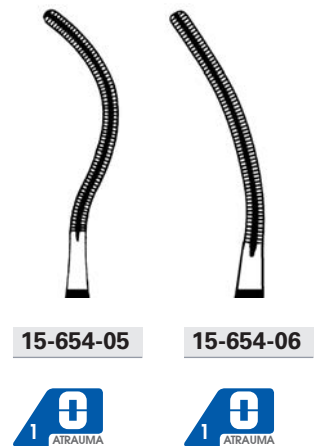

COOLEY

15-654-05 - 15-654-06 14,5 cm, 5 3/4"

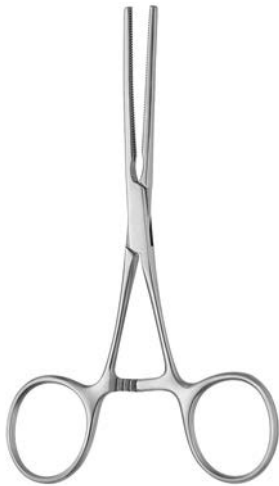

COOLEY

15-655-01	12,5 cm, 5 "
15-655-02	11,5 cm, 4 ½ "

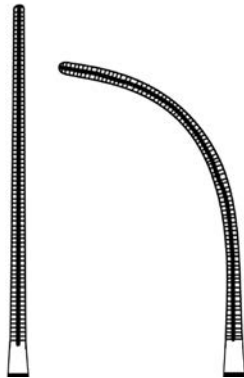

15-655-01

15-655-02



COOLEY

15-655-03	10,0 cm, 4 "
------------------	--------------

15-655-03



COOLEY

15-655-04	12,5 cm, 5 "
------------------	--------------

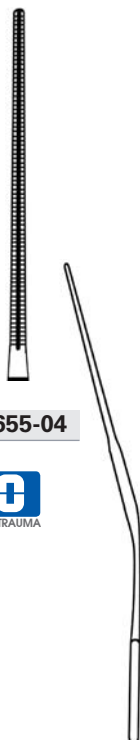

15-655-04



15-655-08

15-655-09



COOLEY

15-655-08	12,0 cm, 4 ¾ "
15-655-09	11,5 cm, 4 ½ "

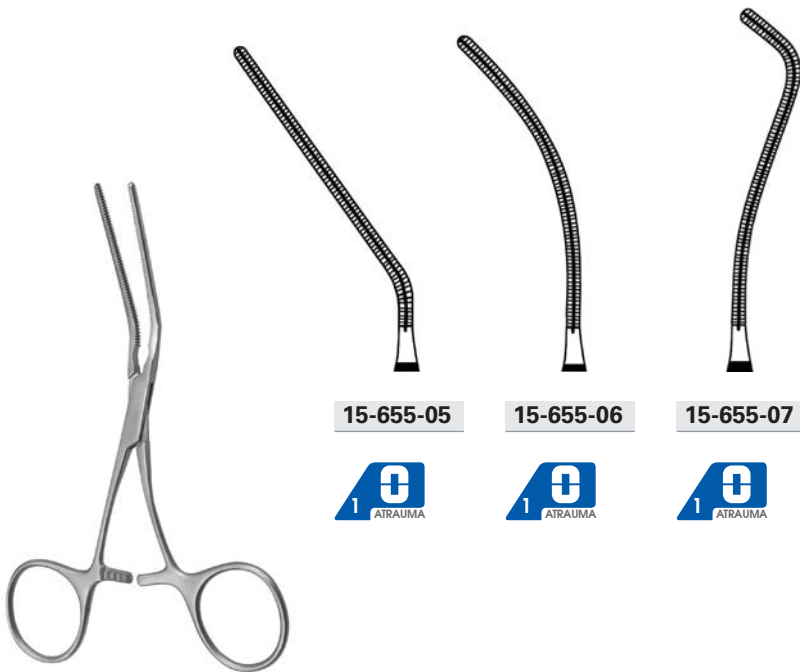

15-655-05

15-655-06

15-655-07



COOLEY

15-655-05	12,0 cm, 4 3/4"
15-655-06	12,5 cm, 5"
15-655-07	12,5 cm, 5"



15-659-01

15-659-02

15-659-03

15-659-04

15-659-05

15-659-06



COOLEY

15-659-01	13,5 cm, 5 1/4"
15-659-02	13,5 cm, 5 1/4"
15-659-03	14,0 cm, 5 1/2"
15-659-04	13,5 cm, 5 1/4"
15-659-05	13,5 cm, 5 1/4"
15-659-06	12,5 cm, 5"
15-659-07	13,0 cm, 5 1/8"
15-659-08	13,5 cm, 5 1/4"
15-659-09	13,0 cm, 5 1/8"

15-659-07

15-659-08

15-659-09



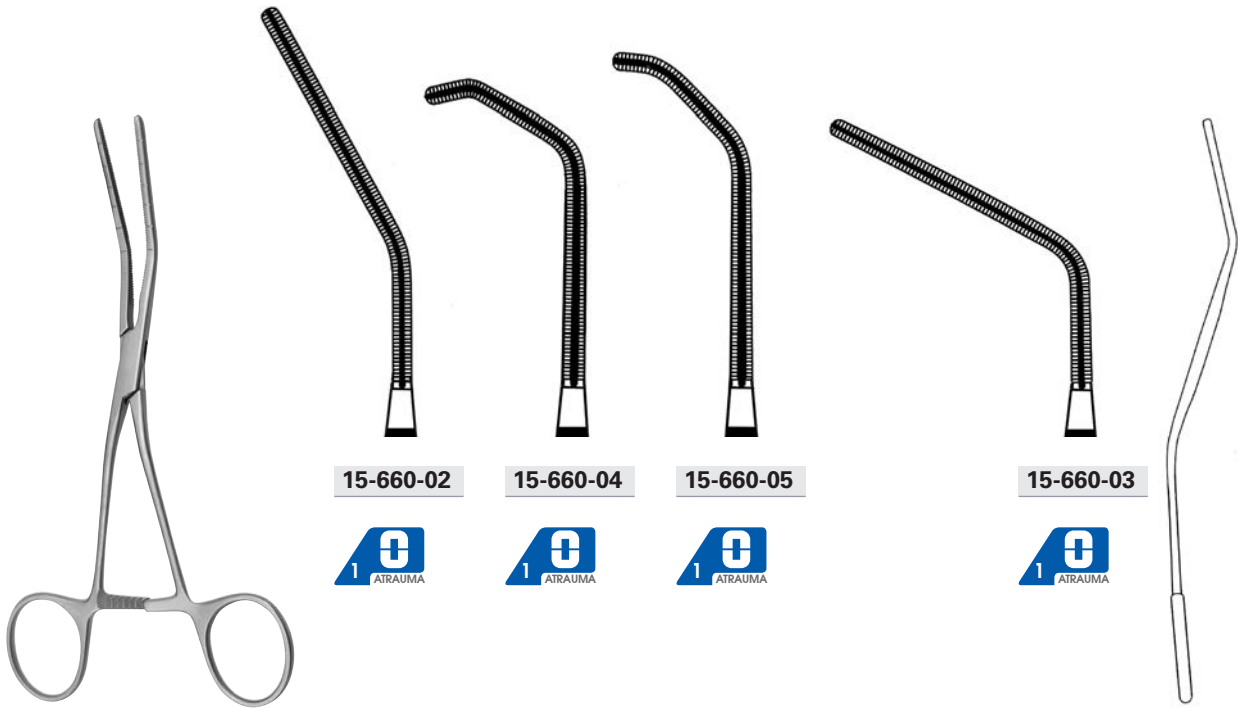

COOLEY

15-660-02	16,0 cm, 6 ¼"
15-660-03	15,5 cm, 6 ⅛"
15-660-04	15,5 cm, 6 ⅛"
15-660-05	16,0 cm, 6 ¼"



COOLEY

15-660-01	16,5 cm, 6 ½"
------------------	---------------

COOLEY

15-661-01	17,0 cm, 6 ¾"
------------------	---------------

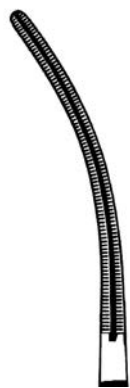

15-661-02



COOLEY

15-661-02 17,0 cm, 6 3/4"



15-661-03



COOLEY

15-661-03 17,5 cm, 7"



15-661-04



COOLEY

15-661-04	16,5 cm, 6 1/2"
15-661-05	17,0 cm, 6 3/4"
15-661-06	15,0 cm, 6"
15-661-07	15,5 cm, 6 1/8"
15-661-08	17,0 cm, 6 3/4"



15-661-05

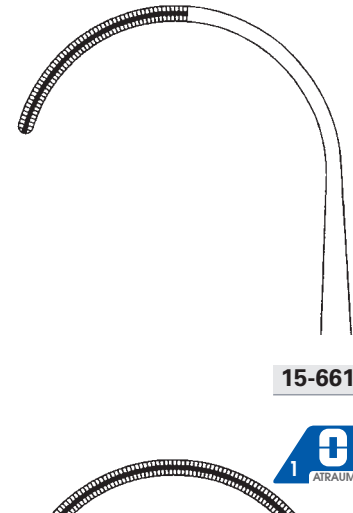

15-661-08

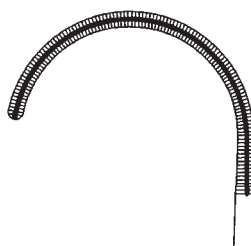

15-661-06

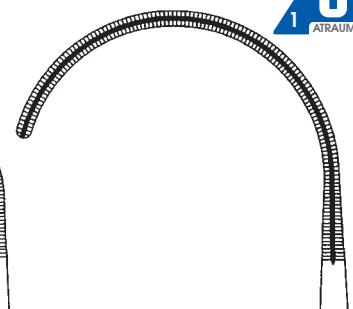

15-661-07





15-663-16

15-663-17

15-663-18



COOLEY

15-663-16	16,5 cm, 6 1/2"
15-663-17	17,0 cm, 6 3/4"
15-663-18	17,5 cm, 7"



15-663-20

15-665-17



COOLEY-LEITZ

16-663-20	20,5 cm, 8"
-----------	-------------

COOLEY-BECK

15-665-17	17,0 cm, 6 3/4"
-----------	-----------------

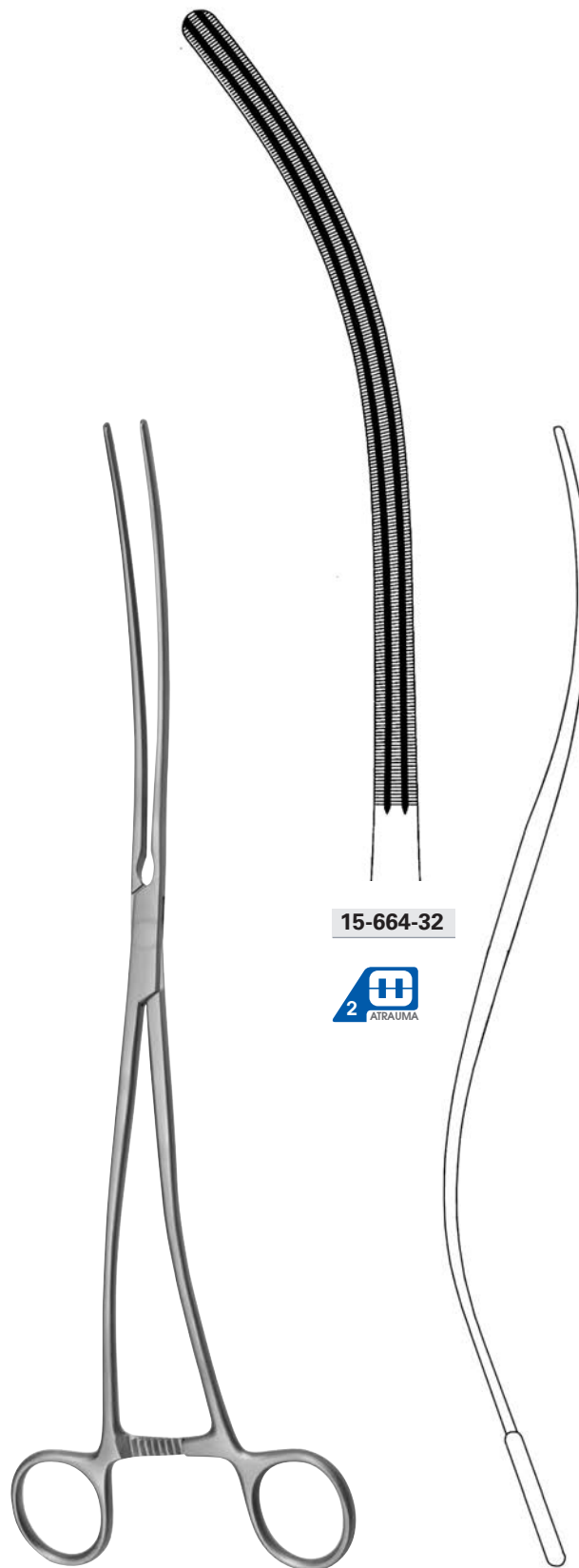

15-664-32



COOLEY

15-664-32 32,0 cm, 12 1/2"

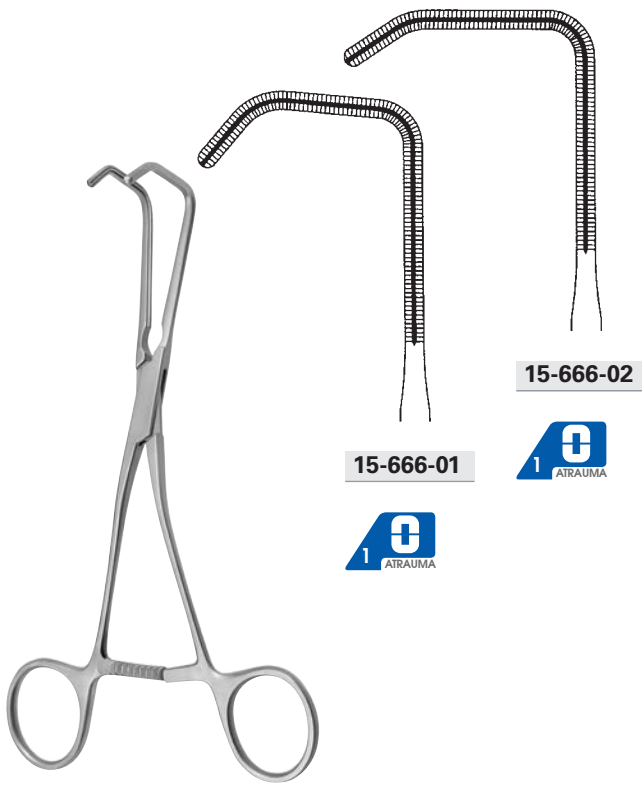

15-666-01

15-666-02



COOLEY

15-666-01 - 15-666-02 16,5 cm, 6 1/2"



15-667-17



COOLEY

15-667-17 17,0 cm, 6 3/4"



15-667-18



COOLEY

15-667-18 17,5 cm, 7"



15-669-16



COOLEY

15-669-16 16,0 cm, 6 1/4"



15-669-17

15-669-18



COOLEY

15-669-17 17,5 cm, 7 "
 15-669-18 18,0 cm, 7 "



15-671-15



COOLEY

15-671-15 15,0 cm, 6 "

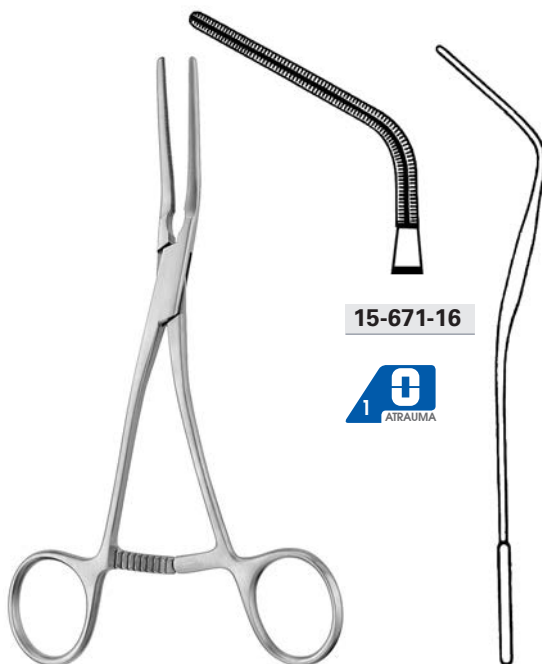

15-671-16



COOLEY

15-671-16 16,0 cm, 6 ¼ "

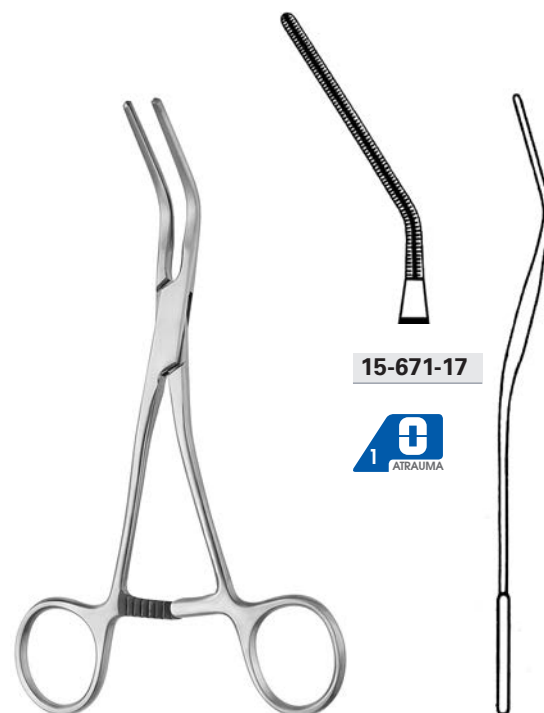

15-671-17



COOLEY

15-671-17 16,5 cm, 6 ½ "



15-672-16

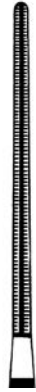

15-672-17

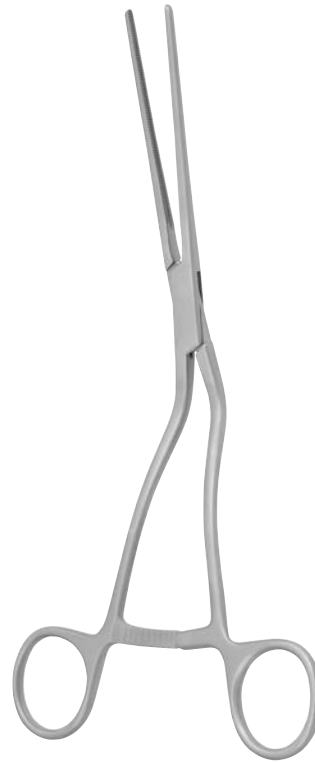

15-673-21

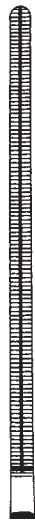

15-673-27



COOLEY

15-672-16	16,0 cm, 6 1/4"
15-672-17	17,0 cm, 6 3/4"

COOLEY

15-673-21	22,0 cm, 8 3/4"
15-673-27	27,0 cm, 10 3/4"



15-675-18



15-675-19

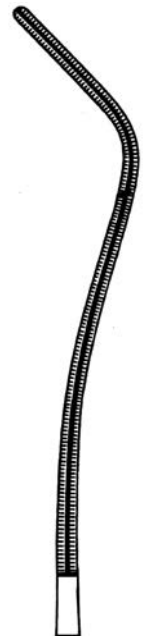

15-675-20
15-675-26



COOLEY

15-675-18	18,5 cm, 7 1/4"
15-675-19	19,5 cm, 7 3/4"

COOLEY

15-675-20	20,0 cm, 8"
15-675-26	26,0 cm, 10 1/4"

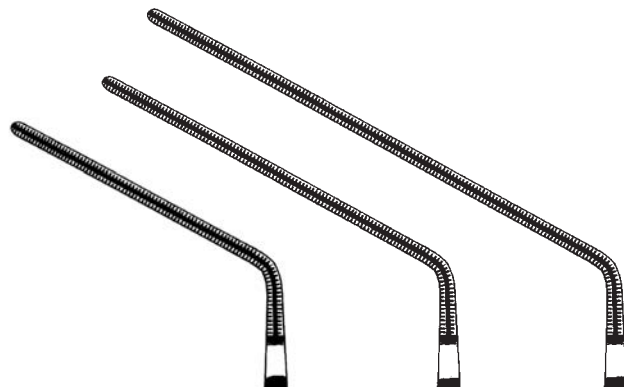
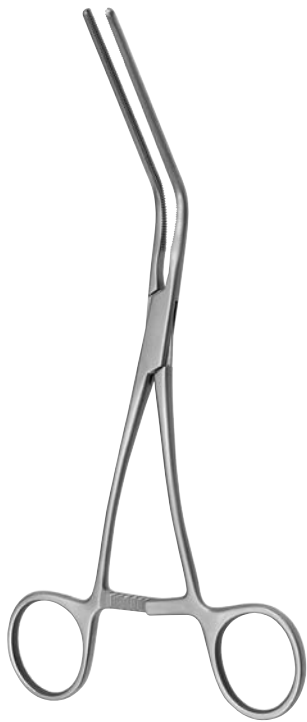

15-678-01

15-678-02

15-678-03



15-679-28



COOLEY

15-678-01	16,5 cm, 6 1/2"
15-678-02	17,0 cm, 6 3/4"
15-678-03	18,5 cm, 7 1/4"

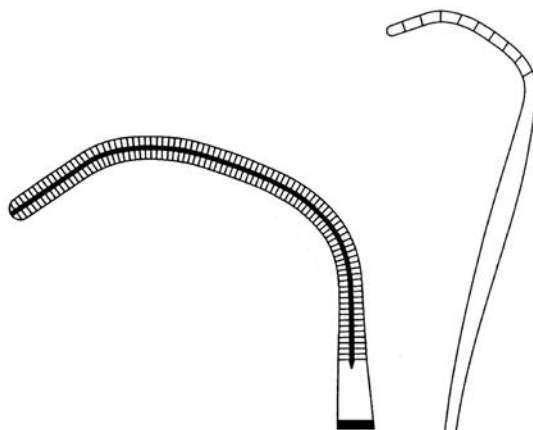
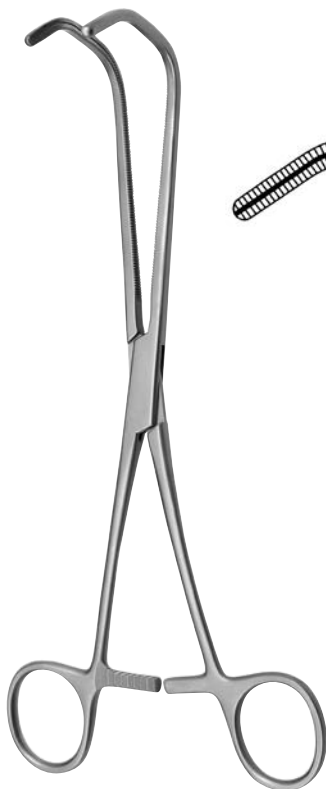

15-679-22



COOLEY

15-679-22	22,0 cm, 8 3/4"
-----------	-----------------



COOLEY

15-679-28	28,5 cm, 11 1/4"
-----------	------------------

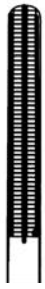

15-680-00



15-680-15

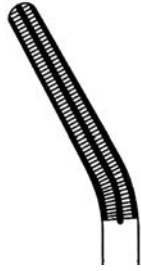

15-680-30

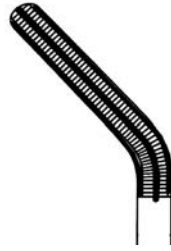

15-680-45



15-680-90

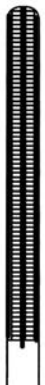

15-682-00



15-682-15

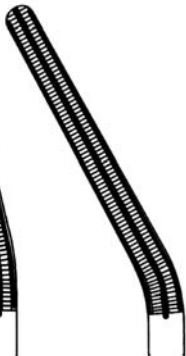

15-682-30

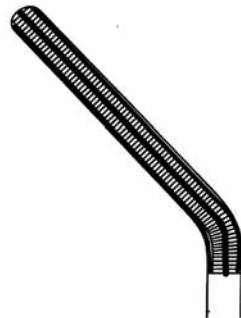

15-682-45

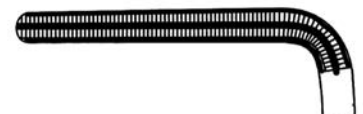

15-682-90



DARDIK

15-680-00 - 15-680-90 15,0 cm, 6 "

15-682-00 - 15-682-90 17,0 cm, 6 3/4 "

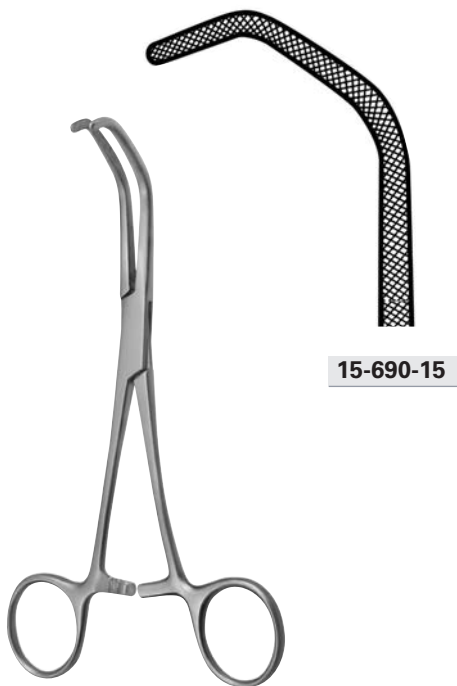

BABY-SATINSKY

15-690-15 15,0 cm, 6 "

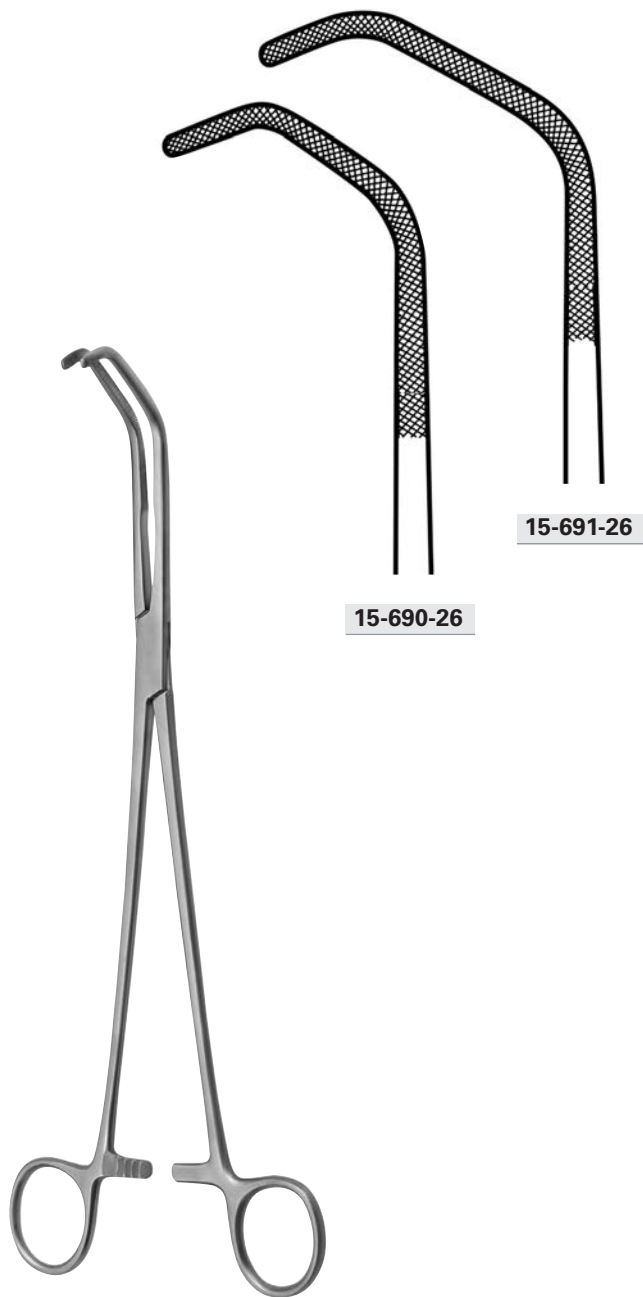

SATINSKY

15-690-26 - 15-691-26 26,5 cm, 10 1/2 "

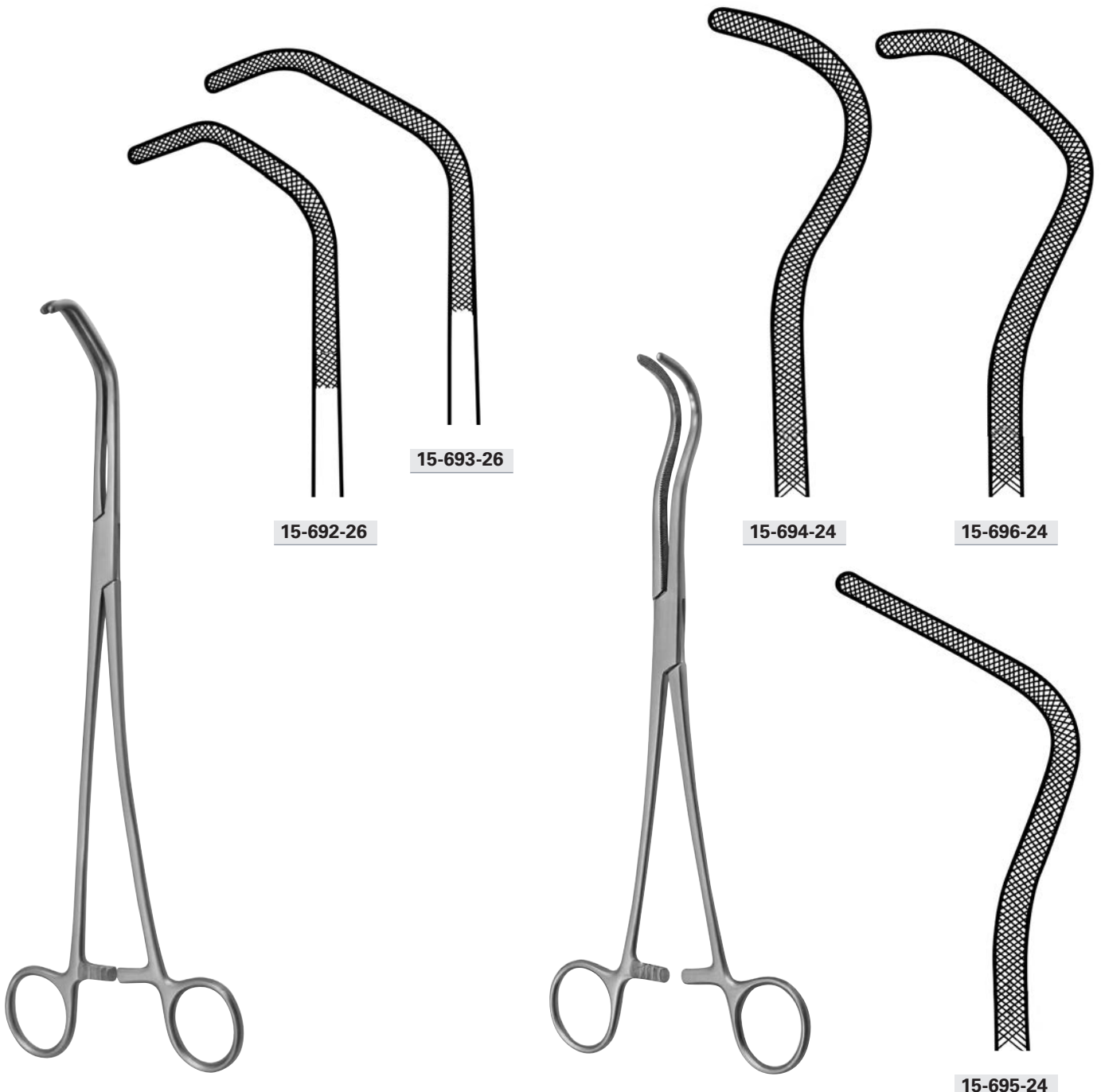

15-692-26

15-693-26

15-694-24

15-696-24

15-695-24

SATINSKY-S

15-692-26 - 15-693-26 26,5 cm, 10 ½"

HARKEN

15-694-24 - 15-696-24 24,0 cm, 9 ½"

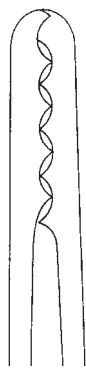
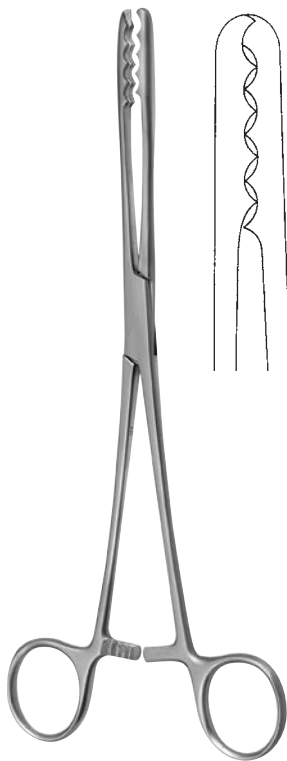

15-700-22

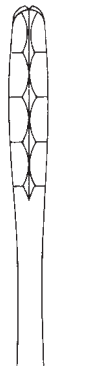

15-701-22



15-700-27

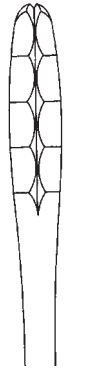

15-701-27

ULRICH

15-700-22 - 15-701-22	22,5 cm, 9"
15-700-27 - 15-701-27	26,5 cm, 10 1/2"



GROSS-MAIER

15-702-20	20,0 cm, 8"
15-702-22	22,0 cm, 8 3/4"
15-702-25	25,0 cm, 9 3/4"
15-702-27	27,0 cm, 10 3/4"

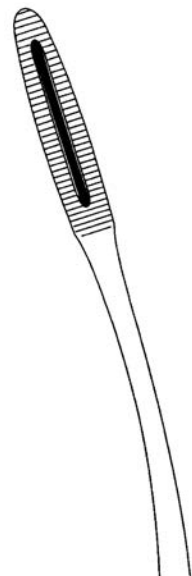
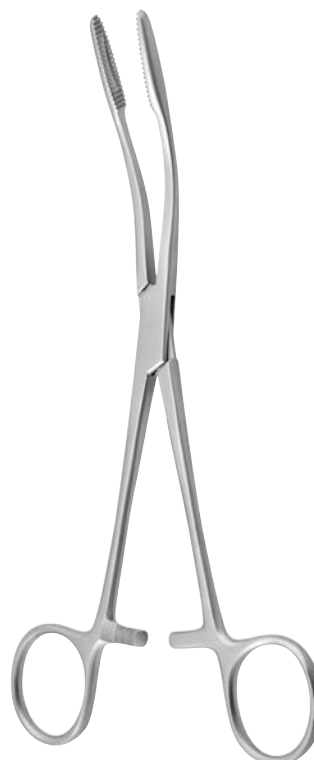

GROSS-MAIER

15-703-20	20,0 cm, 8"
15-703-22	22,0 cm, 8 3/4"
15-703-25	25,0 cm, 9 3/4"
15-703-27	27,0 cm, 10 3/4"



GROSS-MAIER

15-704-20	20,0 cm, 8 "
15-704-22	22,0 cm, 8 3/4 "
15-704-25	25,0 cm, 9 3/4 "
15-704-27	27,0 cm, 10 3/4 "

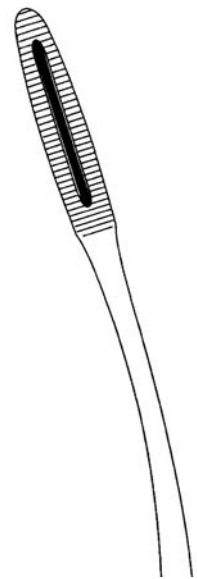

GROSS-MAIER

15-705-20	20,0 cm, 8 "
15-705-22	22,0 cm, 8 3/4 "
15-705-25	25,0 cm, 9 3/4 "
15-705-27	27,0 cm, 10 3/4 "



GROSS

15-706-14	14,5 cm, 5 3/4 "
15-706-16	16,0 cm, 6 1/4 "
15-706-18	18,0 cm, 7 "
15-706-20	20,0 cm, 8 "
15-706-25	25,0 cm, 9 3/4 "



GROSS

15-707-14	14,5 cm, 5 3/4 "
15-707-18	18,0 cm, 7 "
15-707-20	20,0 cm, 8 "
15-707-25	25,0 cm, 9 3/4 "

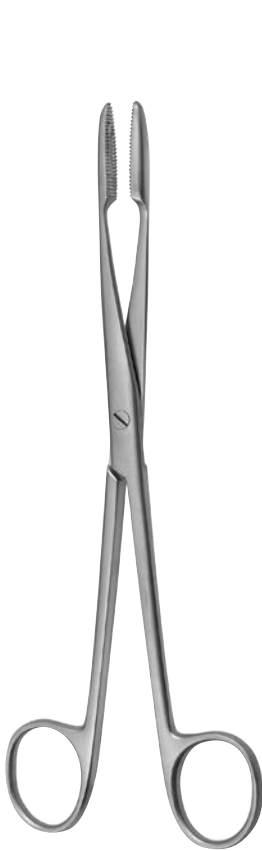

GROSS

15-708-14	14,5 cm, 5 3/4"
15-708-18	18,0 cm, 7"
15-708-20	20,0 cm, 8"
15-708-25	25,0 cm, 9 3/4"



GROSS

15-709-14	14,5 cm, 5 3/4"
15-709-18	18,0 cm, 7"
15-709-20	20,0 cm, 8"
15-709-25	25,0 cm, 9 3/4"

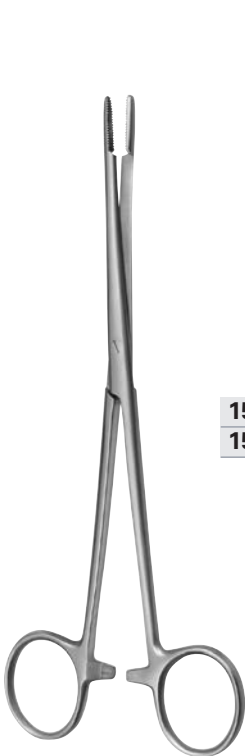

15-710-17
15-710-25



15-711-17
15-711-25

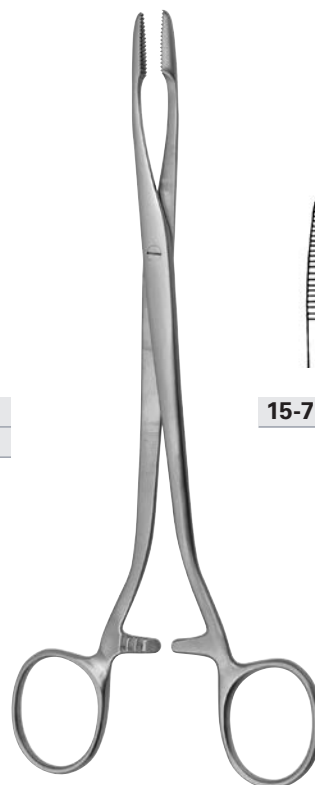

15-712-21

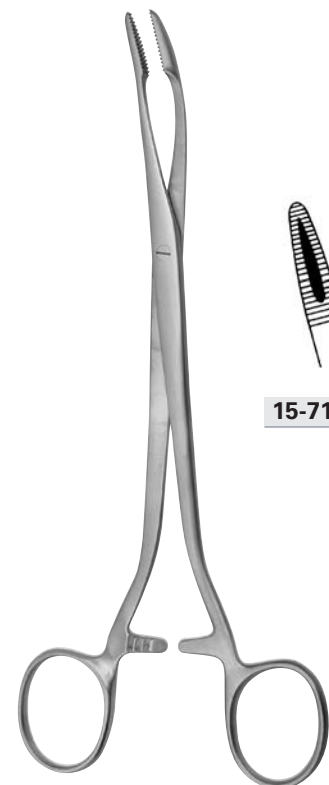

15-713-21



MARTIN

15-710-17 - 15-711-17	17,0 cm, 6 3/4"
15-710-25 - 15-711-25	25,0 cm, 9 3/4"

DUPLAY

15-712-21	21,0 cm, 8 1/4"
------------------	-----------------

DUPLAY

15-713-21	21,0 cm, 8 1/4"
------------------	-----------------



15-713-19

DUPLAY-S

15-713-19 19,0 cm, 7 1/2"



15-713-22

PITHA

15-713-22 22,0 cm, 8 3/4"



15-714-13

15-714-16

15-714-18

Sinusklemmen
Sinus forceps
Pinzas para vendajes
Pinze per seni

LISTER

15-714-13 13,0 cm, 5"
15-714-16 16,0 cm, 6 1/4"
15-714-18 18,0 cm, 7"



15-715-13

BRYANT

15-715-13 13,0 cm, 5"



15-716-26

BOZEMANN

15-716-26 26,0 cm, 10 1/4"



15-717-26

BOZEMANN-S

15-717-26 26,0 cm, 10 1/4"

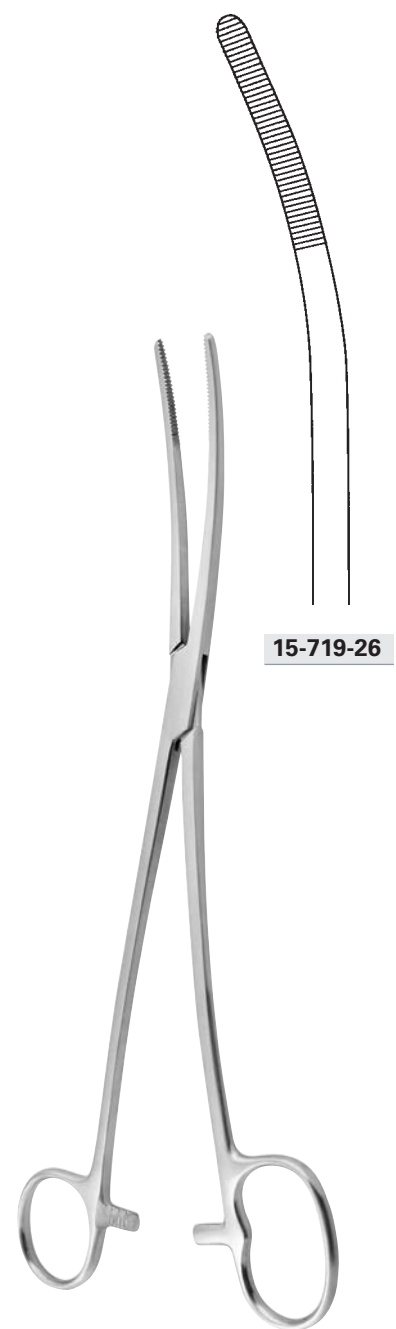

15-719-26

BOZEMANN-DOUGLAS

15-719-26 26,0 cm, 10 1/4"



15-718-21

EMMET

15-718-21 21,0 cm, 8 ¼"



15-718-25

COLLIN

15-718-25 25,0 cm, 9 ¾"



15-719-25

CHERON

15-719-25 25,0 cm, 9 ¾"

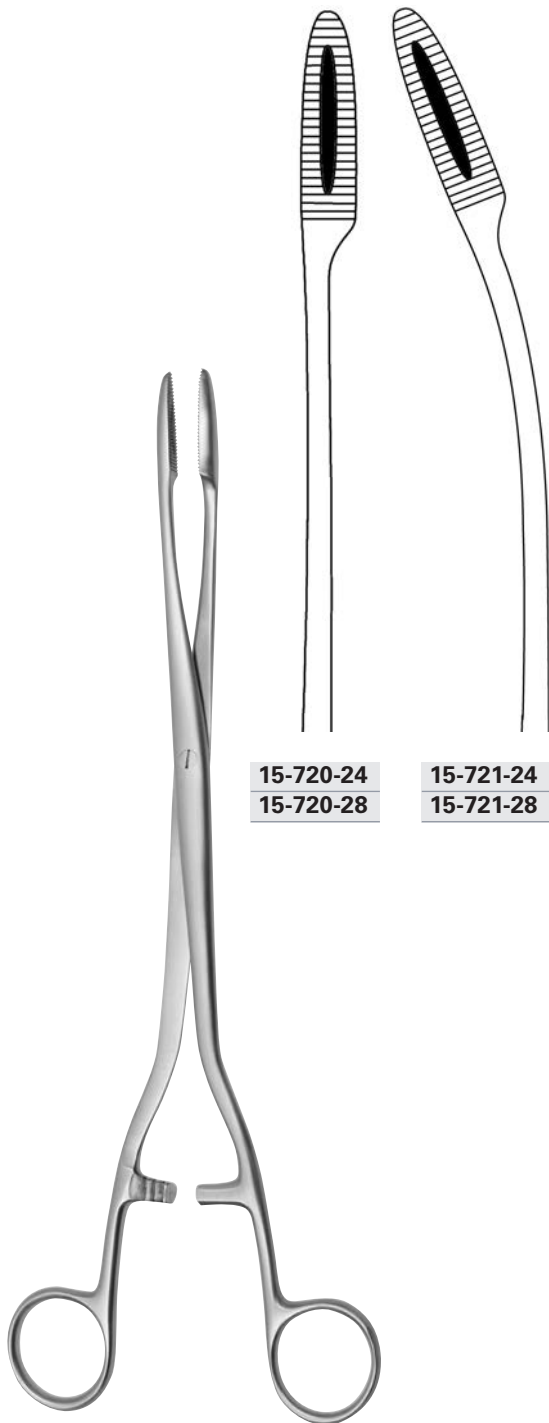

15-720-24
15-720-28

15-721-24
15-721-28



15-722-25

15-723-25

SIMS-MAIER

15-720-24 - 15-721-24 24,0 cm, 9 1/2 "
15-720-28 - 15-721-28 28,0 cm, 11 "

PELKMANN

15-722-25 - 15-723-25 25,0 cm, 9 3/4 "

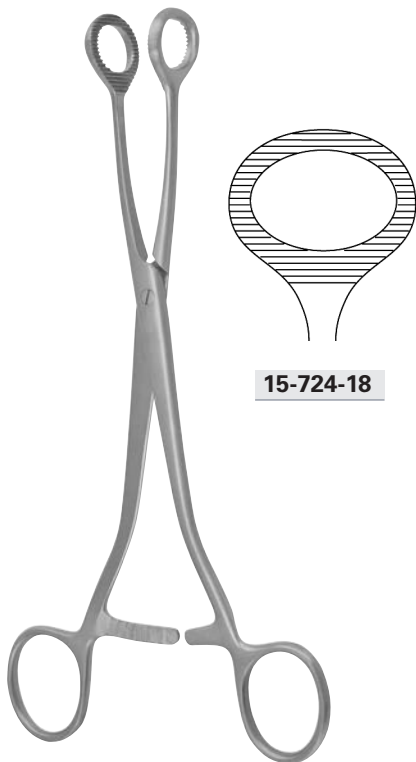

15-724-18

DOYEN

15-724-18 20,0 cm, 8"



BUMM

15-724-28 28,0 cm, 11"



15-725-32

KELLY

15-725-32 32,0 cm, 12 1/2"

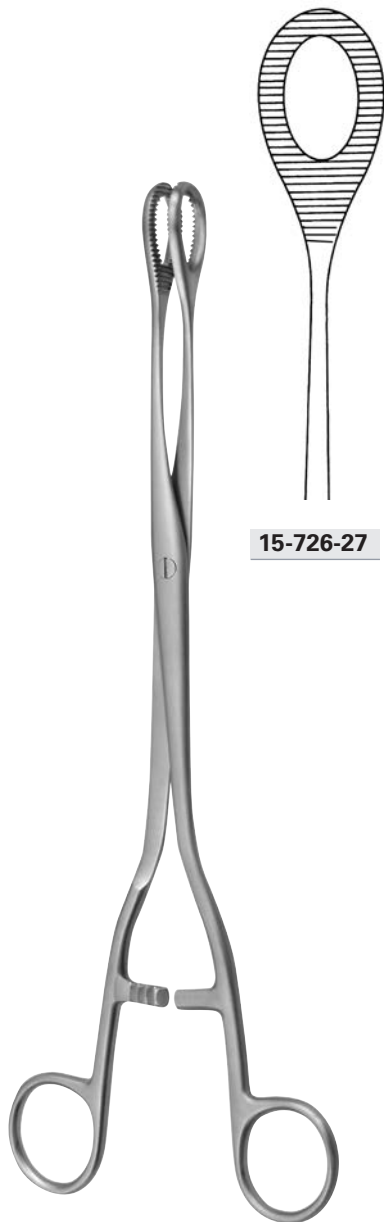

15-726-27

NOTO

15-726-27 27,5 cm, 10 3/4"



15-728-25

HEYWOOD-SMITH

15-728-25 25,0 cm, 10"

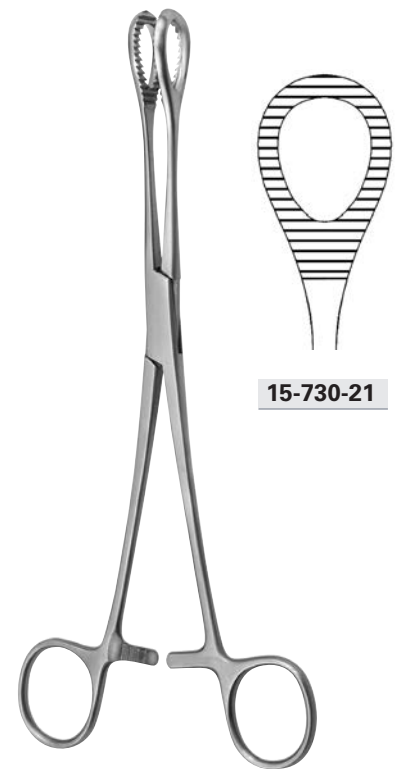

15-730-21

HEYWOOD-SMITH

15-730-21 20,5 cm, 8"

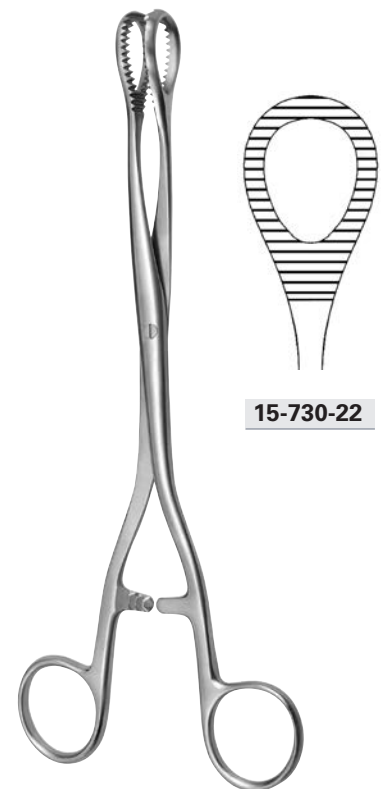

15-730-22

HEYWOOD-SMITH

15-730-22 21,0 cm, 8 1/4"

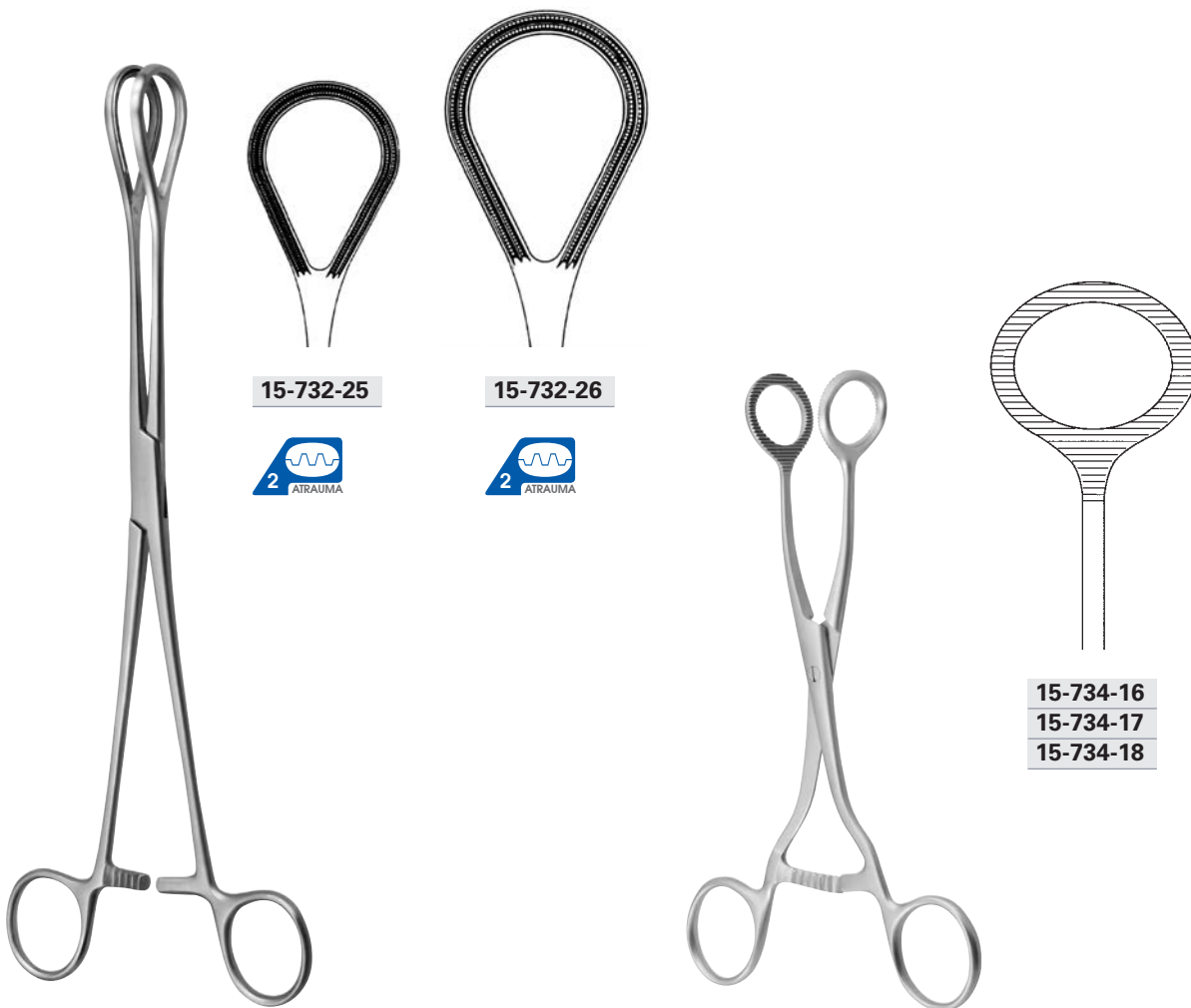

15-732-25	25,0 cm, 9 3/4"
15-732-26	26,0 cm, 10 1/4"

COLLIN

15-734-16	16,0 cm, 6 1/4"
15-734-17	17,0 cm, 6 3/4"
15-734-18	18,0 cm, 7"



15-736-18
15-736-20
15-736-25

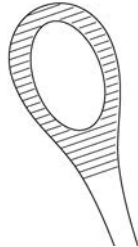

15-737-18
15-737-20
15-737-25



15-738-18
15-738-20
15-738-25



15-739-18
15-739-20
15-739-25

FOERSTER-BALLENGER

15-736-18 - 15-739-18	18,0 cm, 7 "
15-736-20 - 15-739-20	20,0 cm, 8 "
15-736-25 - 15-739-25	25,0 cm, 9 3/4 "

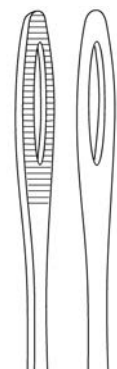

15-740-25

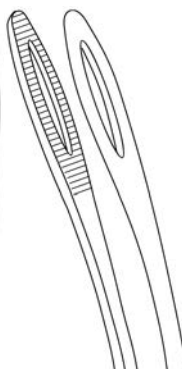

15-741-25

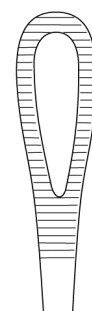

15-742-18

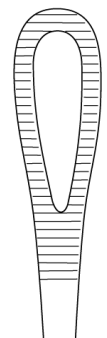

15-742-25

FOERSTER

15-740-25 - 15-741-25	25,0 cm, 9 3/4 "
-----------------------	------------------

RAMPLEY

15-742-18	18,0 cm, 7 "
15-742-25	25,0 cm, 9 3/4 "



15-744-16

WILLIAMS

15-744-16 16,0 cm, 6 1/4"



15-744-24

BONNEY

15-744-24 24,0 cm, 9 1/2"



15-750-14
15-750-18
15-750-20

DUVAL

15-750-14 14,0 cm, 5 1/2"
15-750-18 18,0 cm, 7"
15-750-20 20,0 cm, 8"

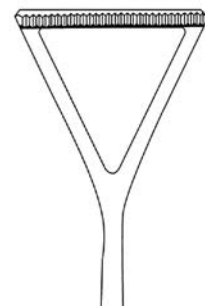

15-752-20
15-752-23

DUVAL

15-752-20 20,0 cm, 8"
15-752-23 23,0 cm, 9"

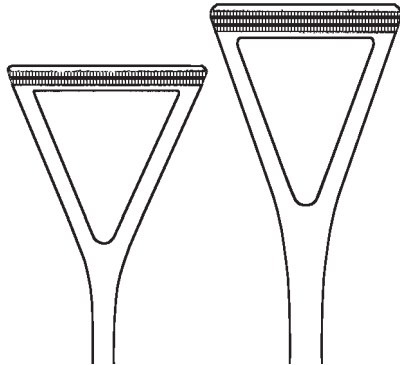

15-751-19

15-751-23



DUVAL

15-751-19 19,5 cm, 7 3/4 "
 15-751-23 23,0 cm, 9 "

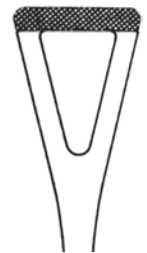

15-753-20



DUVAL

15-753-20 20,0 cm, 8 "

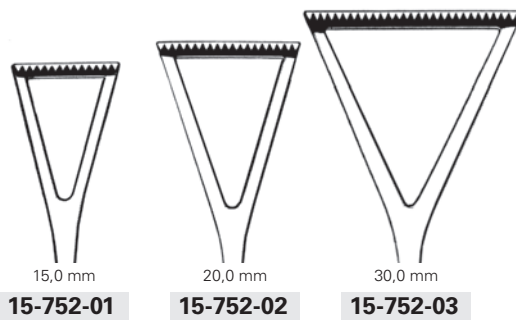

15-752-01

15-752-02

15-752-03



15-754-14

DUVAL-COLLIN

15-752-01 - 15-752-03 19,0 cm, 7 1/2 "

COLLIN

15-754-14 14,0 cm, 5 1/2 "



15-755-18

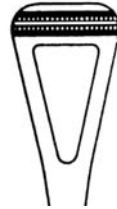

15-755-20

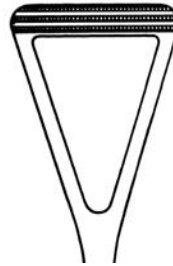

15-755-23



15-756-15
15-756-20



SCHEIBE

15-755-18	18,0 cm, 7 "
15-755-20	20,0 cm, 8 "
15-755-23	23,0 cm, 9 "

PENNINGTON

15-756-15	15,0 cm, 6 "
15-756-20	20,0 cm, 8 "



15-758-20



LOCKWOOD

15-758-20	20,0 cm, 8 "
-----------	--------------

BABCOCK

15-760-16	16,0 cm, 6 ¼ "
15-760-18	18,0 cm, 7 "
15-760-20	20,0 cm, 8 "
15-760-24	24,0 cm, 9 ½ "
15-760-36	36,0 cm, 14 "
15-760-40	40,0 cm, 16 "



15-762-16

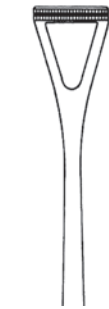

15-762-20



15-762-22



15-764-16

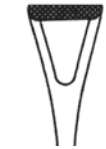

15-764-20



BABCOCK

15-762-16	16,0 cm, 6 1/4"
15-762-20	20,5 cm, 8"
15-762-22	22,0 cm, 8 3/4"

BABCOCK

15-764-16	16,0 cm, 6 1/4"
15-764-20	20,5 cm, 8"



2 x 3



15-765-02

3 x 4



15-765-03



4 x 5



15-766-12



4 x 5



15-766-14

ALLIS

15-765-02 - 15-765-03	15,5 cm, 6 1/8"
-----------------------	-----------------

BABY-ALLIS

15-766-12	12,5 cm, 5"
-----------	-------------

ALLIS

15-766-14	15,0 cm, 6"
-----------	-------------



5 x 6



15-766-15
15-766-19
15-766-22
15-766-25



15-768-16
15-768-20
15-768-22
15-768-25
15-768-30



ALLIS

15-766-15	15,0 cm, 6 "
15-766-19	19,0 cm, 7 1/2 "
15-766-22	22,0 cm, 8 3/4 "
15-766-25	25,0 cm, 9 3/4 "

ALLIS

15-768-16	16,0 cm, 6 1/4 "
15-768-20	20,0 cm, 8 "
15-768-22	22,0 cm, 8 3/4 "
15-768-25	25,0 cm, 9 3/4 "
15-768-30	30,0 cm, 11 3/4 "



6 x 7



15-770-20



5 x 6



15-770-21
15-770-22

THOMS-ALLIS

15-770-20	20,0 cm, 8 "
------------------	--------------

ALLIS

15-770-21	20,0 cm, 8 "
15-770-22	22,0 cm, 8 3/4 "

3 x 4



15-772-15
15-772-19

JUDD-ALLIS

15-772-15 15,5 cm, 6 1/8"
15-772-19 19,0 cm, 7 1/2"

4 x 5



15-772-16
15-772-20

LOCKWOOD-ALLIS

15-772-16 16,0 cm, 6 1/4"
15-772-20 20,0 cm, 8"



LITTLEWOOD

15-773-19 19,0 cm, 7 1/2"

5 x 6



15-774-15

BOYS-ALLIS

15-774-15 15,0 cm, 6"

10 x 11

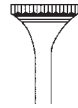

15-776-15

ALLIS-ADAIR

15-776-15 16,0 cm, 6 1/4"

4 x 5



15-778-13

TUFFIER

15-778-13 13,0 cm, 5 1/8"



CHAPUT

15-780-13 13,0 cm, 5 1/8"



WILLET-MARTEL

15-786-14 14,0 cm, 5 1/2"
15-784-19 18,5 cm, 7 1/4"

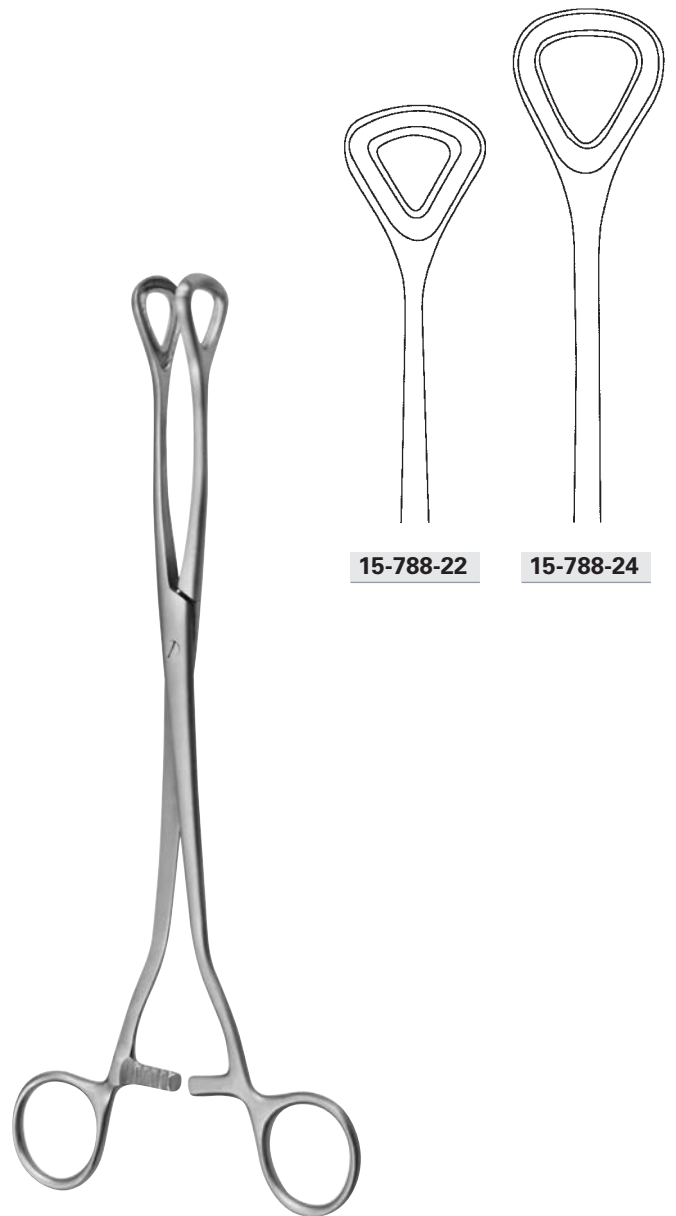

LUER

15-788-22 22,0 cm, 8 3/4"
15-788-24 24,5 cm, 9 2/3"



BACKHAUS-KOCHER

15-800-13 13,0 cm, 5 1/8"



15-801-08
15-801-11
15-801-13
15-801-15

BACKHAUS

15-801-08	8,0 cm, 3 1/8"
15-801-11	11,0 cm, 4 3/8"
15-801-13	13,0 cm, 5 1/8"
15-801-15	15,0 cm, 6"

Kabelhalterung bis Ø 5,0 mm
Holder for cable up to Ø 5,0 mm
Porta cable nastaa Ø 5,0 mm
Porta cavo fino a Ø 5,0 mm

Schlauchhalterung bis Ø 13,0 mm
Holder for rubber tube up to Ø 13,0 mm
Porta tubo nastaa Ø 13,0 mm
Porta tubo fino a Ø 13,0 mm

Schlauchhalterung bis Ø 15,0 mm
Holder for rubber tube up to Ø 15,0 mm
Porta tubo nastaa Ø 15,0 mm
Porta tubo fino a Ø 15,0 mm



ROBIN

15-802-13 13,0 cm, 5 1/8"



ROBIN

15-802-14 13,0 cm, 5 1/8"



BACKHAUS

15-803-11 11,0 cm, 4 3/8"

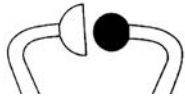

BALL & SOCKET

15-805-11	11,0 cm, 4 $\frac{3}{8}$ "
15-805-14	14,0 cm, 5 $\frac{1}{2}$ "



BERNHARD

15-807-16	16,0 cm, 6 $\frac{1}{4}$ "
------------------	----------------------------



ROEDER

15-809-13	13,0 cm, 5 $\frac{1}{8}$ "
15-809-15	15,0 cm, 6 "



LANE

15-811-13	13,0 cm, 5 $\frac{1}{8}$ "
15-811-15	15,0 cm, 6 "
15-811-20	20,0 cm, 8 "



DOYEN

15-813-18	18,0 cm, 7 "
------------------	--------------



SCHAEDEL

15-816-09	9,0 cm, 3 $\frac{1}{2}$ "
------------------	---------------------------



SCHAEDEL

15-817-09	9,0 cm, 3 $\frac{1}{2}$ "
------------------	---------------------------



JONES

15-819-05	5,5 cm, 2 1/8"
15-819-09	9,0 cm, 3 1/2"

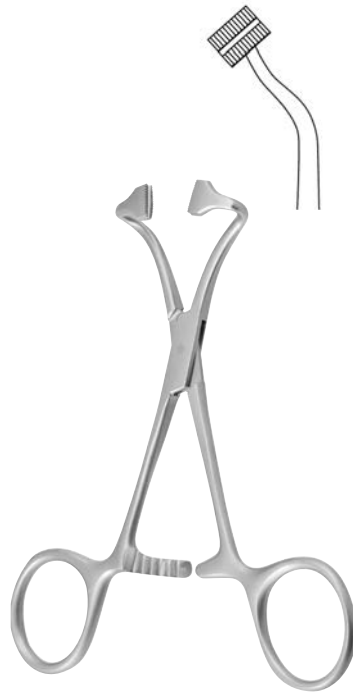

PEERS-BERTRAM

15-821-14	14,5 cm, 5 3/4"
------------------	-----------------



LORNA (EDNA)

15-823-10	9,5 cm, 3 3/4"
15-823-13	13,0 cm, 5 1/8"



TOHOKU

15-825-10	10,0 cm, 4"
15-825-13	13,0 cm, 5 1/8"



15-827-13	13,0 cm, 5 1/8"
------------------	-----------------



HOFF

15-829-10	10,0 cm, 4"
15-829-12	12,0 cm, 4 3/4"
15-829-14	14,0 cm, 5 1/2"

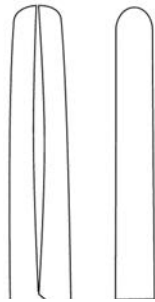

15-840-16
15-840-18
15-840-20
15-840-24

15-840-16	16,0 cm, 6 ¼"
15-840-18	18,0 cm, 7"
15-840-20	20,0 cm, 8"
15-840-24	24,0 cm, 9 ½"



15-842-14
15-842-16
15-842-20

BERLIN

15-842-14	14,0 cm, 5 ½"
15-842-16	16,5 cm, 6 ½"
15-842-20	20,0 cm, 8"



15-844-15



15-844-18



15-844-19



15-844-20

15-844-15	15,0 cm, 6"
15-844-18	18,0 cm, 7"
15-844-19	19,0 cm, 7 ½"
15-844-20	20,0 cm, 8"



15-846-15



15-846-18



15-846-20

15-846-15	15,0 cm, 6 "
15-846-18	18,0 cm, 7 "
15-846-20	20,0 cm, 8 "



AL
 ALUMINIUM

15-849-16 16,0 cm, 6 ¼ "

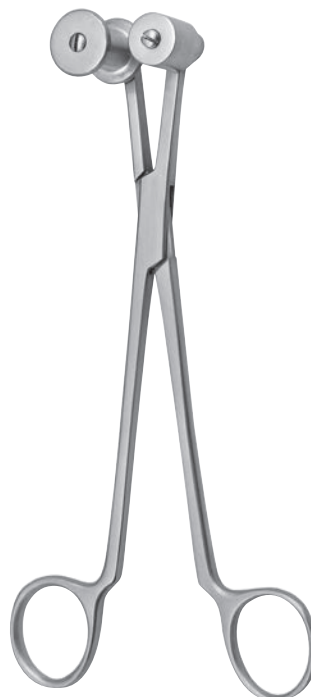

GUNAR-HEY

15-848-18 18,0 cm, 7 "



BUNT

15-851-12 12,0 cm, 4 $\frac{3}{4}$ "



MAYO

15-851-13 13,0 cm, 5 $\frac{1}{6}$ "

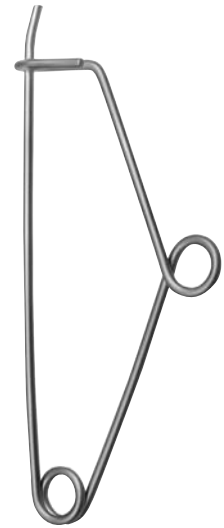

MAYO

15-851-14 14,0 cm, 5 $\frac{1}{2}$ "



16



Wundhaken
Retractors
Separadores
Divaricatori



VOLKMANN

16-001-01 - 16-003-08 22,0 cm, 8 3/4"



16-001-01



16-002-01

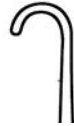

16-003-01



16-001-02



16-002-02



16-003-02



16-001-03



16-002-03



16-003-03



16-001-04

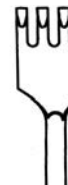

16-002-04



16-003-04

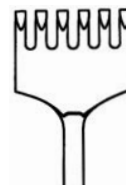

16-001-06



16-002-06



16-003-06

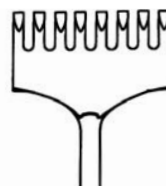

16-001-08

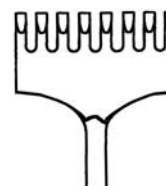

16-002-08

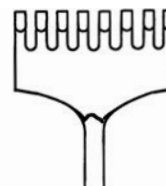

16-003-08

scharf
sharp
agudo
acuto

halbscharf
semi-sharp
semi-agudo
semi-acuto

stumpf
blunt
romo
smusso

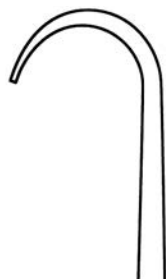

16-001-12



16-003-12



16-001-13



16-003-13

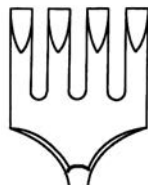

16-001-14

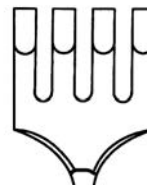

16-003-14

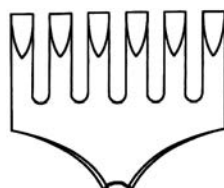

16-001-16

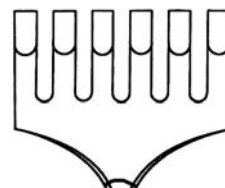

16-003-16

MARTIN

16-001-12 - 16-003-16 22,5 cm, 8 3/4 "

scharf
 sharp
 agudo
 acuto

stumpf
 blunt
 romo
 smusso



KOCHER

16-005-01 - 16-007-08 22,0 cm, 8 3/4"



16-005-01



16-006-01



16-007-01



16-005-02



16-006-02



16-007-02



16-005-03



16-006-03



16-007-03



16-005-04



16-006-04



16-007-04

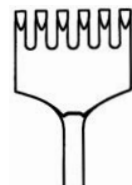

16-005-06



16-006-06

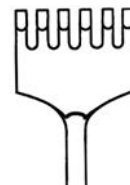

16-007-06

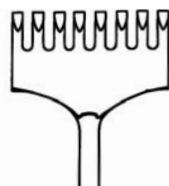

16-005-08

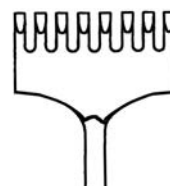

16-006-08

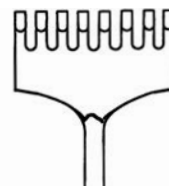

16-007-08

scharf
sharp
agudo
acuto

halbscharf
semi-sharp
semi-agudo
semi-acuto

stumpf
blunt
romo
smusso



16-008-01



16-009-01



16-008-02



16-009-02



16-008-03



16-009-03



16-008-04



16-009-04

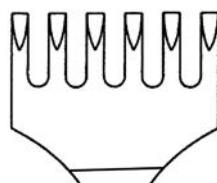

16-008-06

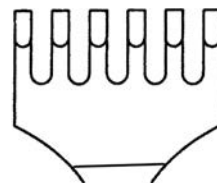

16-009-06

scharf
 sharp
 agudo
 acuto

stumpf
 blunt
 romo
 smusso

VOLKMANN

16-008-01 - 16-009-06 22,0 cm, 8 3/4 "



VOLKMANN

16-010-01	22,0 cm, 8 ³ / ₄ "
16-010-02	22,0 cm, 8 ³ / ₄ "
16-010-03	20,5 cm, 8 "
16-011-01	22,0 cm, 8 ³ / ₄ "
16-012-01	21,5 cm, 8 ¹ / ₂ "
16-012-12	24,5 cm, 9 ² / ₃ "
16-013-01	21,5 cm, 8 ¹ / ₂ "

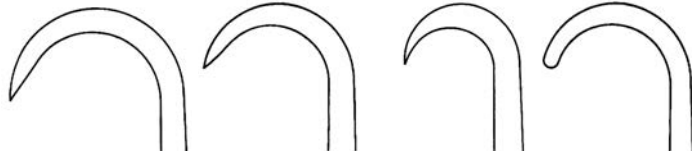

16-010-01

scharf
sharp
agudo
acuto

16-010-02

scharf
sharp
agudo
acuto

16-010-03

scharf
sharp
agudo
acuto

16-011-01

stumpf
blunt
romo
smusso



16-013-01

stumpf
blunt
romo
smusso

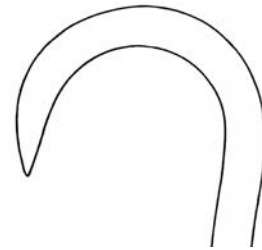

16-012-01

16-012-12

scharf
sharp
agudo
acuto

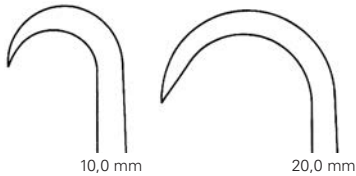

16-013-10

scharf
sharp
agudo
acuto

16-013-20

scharf
sharp
agudo
acuto

16-013-10 - 16-013-20 19,0 cm, 7 ¹/₂ "



LAMBOTTE

16-013-27 27,0 cm, 10 ³/₄ "

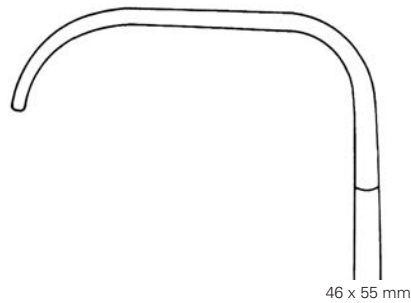

46 x 55 mm
16-015-14

stumpf
blunt
romo
smusso

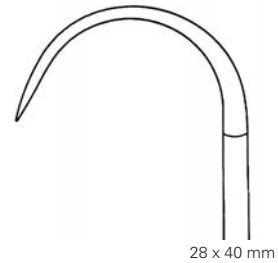

28 x 40 mm
16-015-18

halbscharf
semi-sharp
semi-agudo
semi-acuto

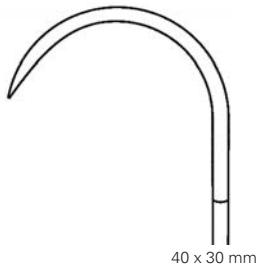
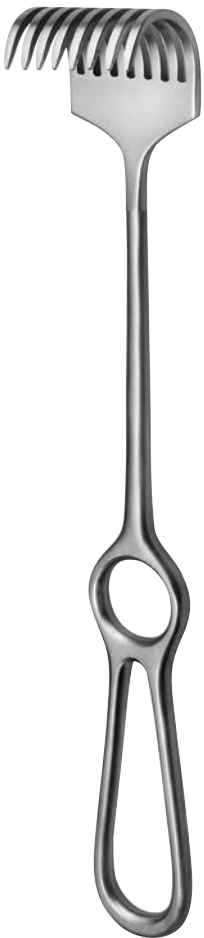

40 x 30 mm
16-014-08

scharf
sharp
agudo
acuto

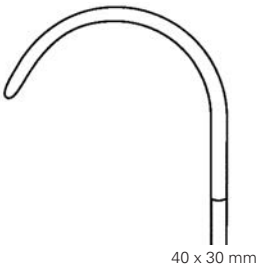

40 x 30 mm
16-015-08

stumpf
blunt
romo
smusso



KOERTE

16-015-14 23,0 cm, 9 "



KOERTE

16-015-18 28,0 cm, 11 "

16-014-08 - 16-015-08 24,5 cm, 9 2/3 "

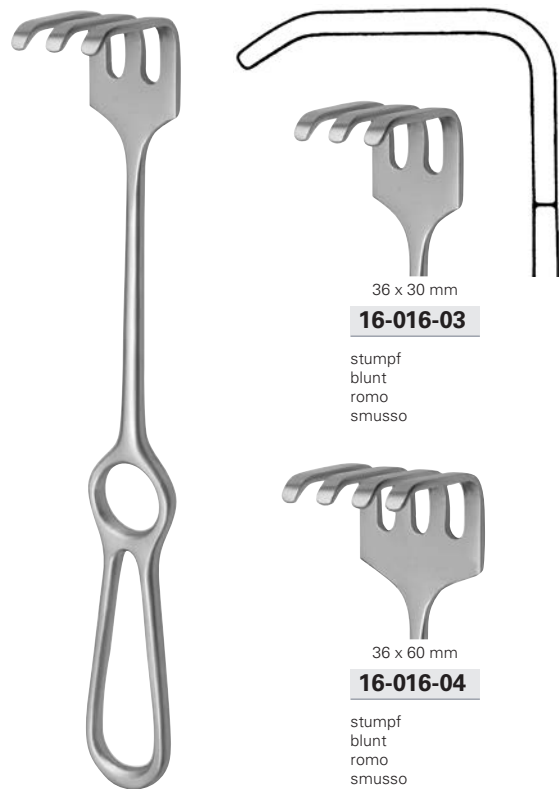

WASSMUND

16-016-02 20,5 cm, 8 "

OLLIER

16-016-03 - 16-016-04 23,0 cm, 9 "

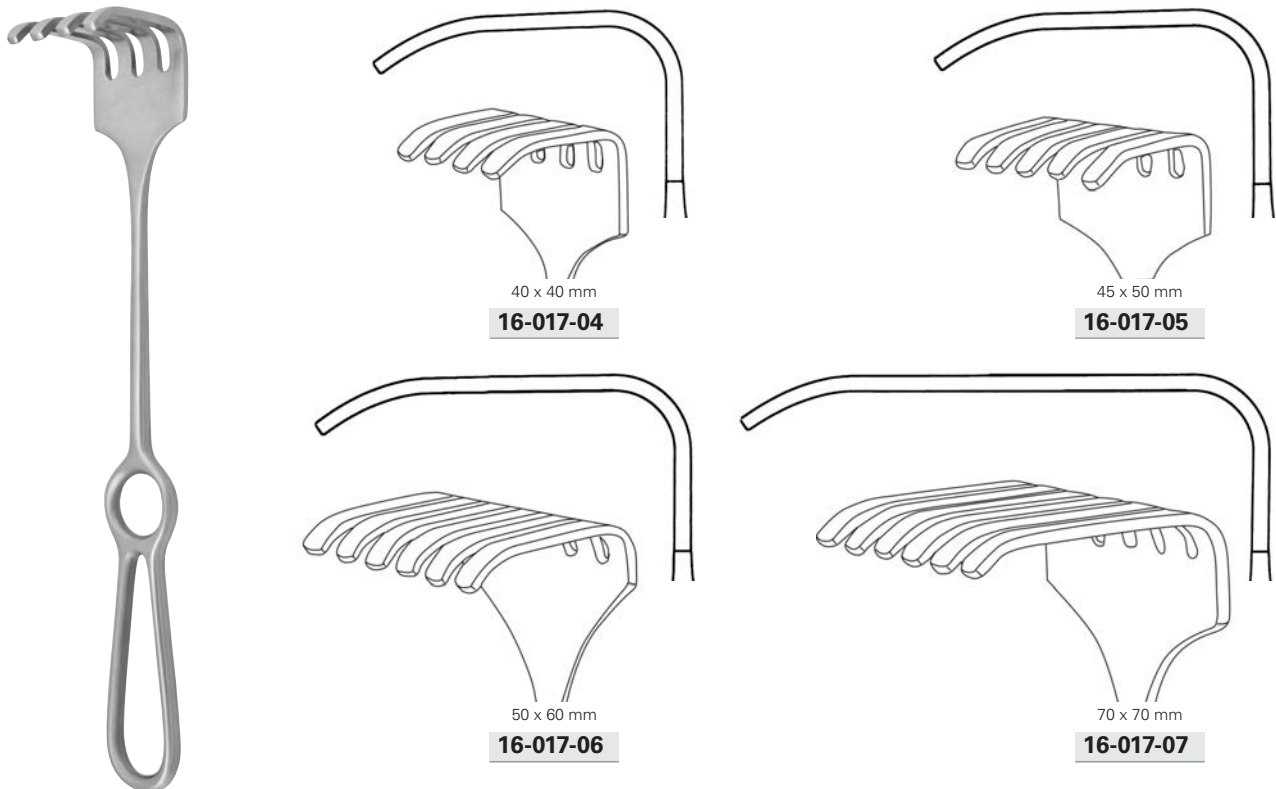

ISRAEL

16-017-04 - 16-017-07 25,5 cm, 10 "

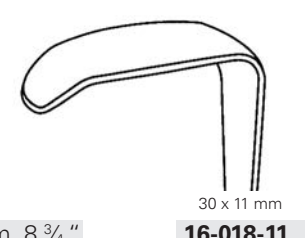
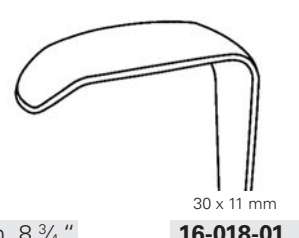
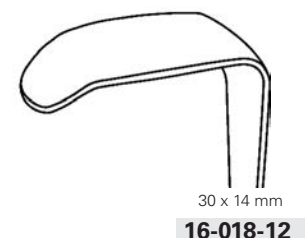
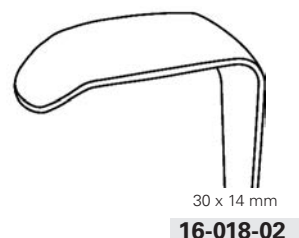
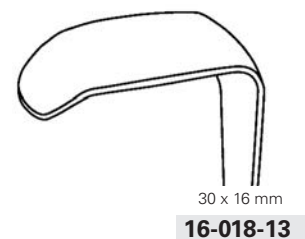
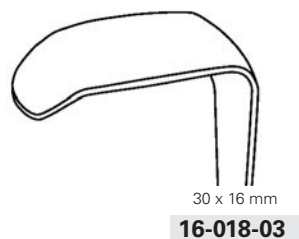
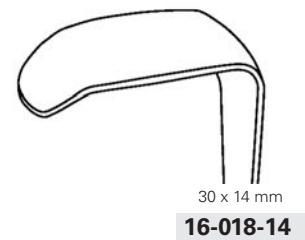
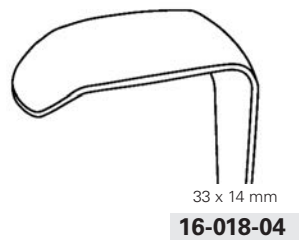
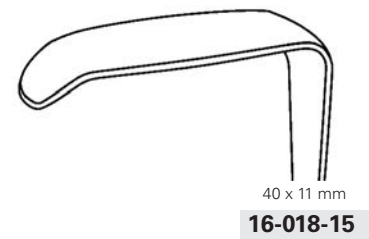
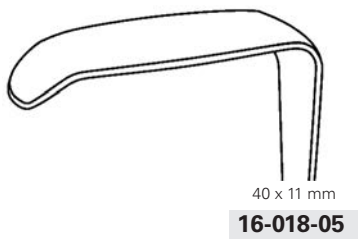
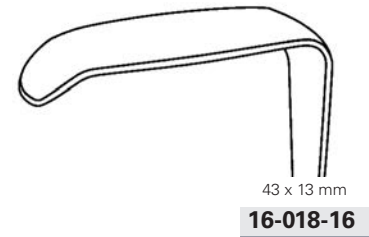
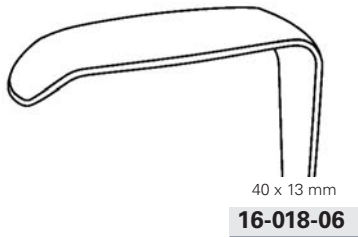
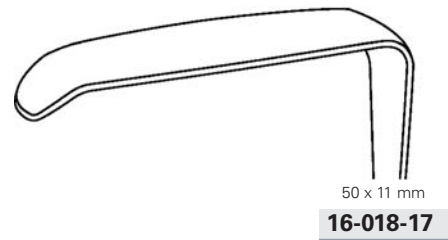
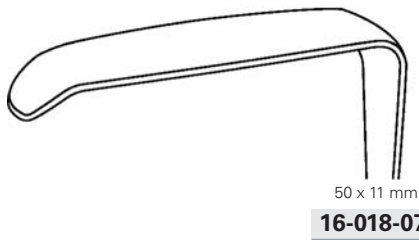

LANGENBECK

16-018-01 - 16-018-07 22,5 cm, 8 3/4 "



LANGENBECK

16-018-11 - 16-018-17 22,5 cm, 8 3/4 "

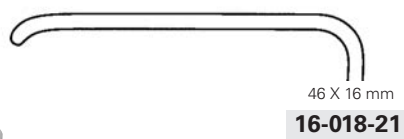
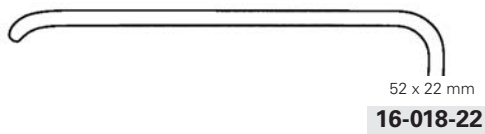
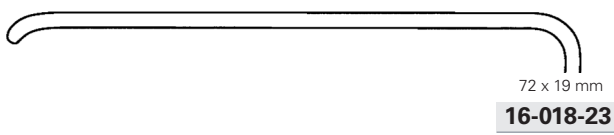

SAUERBRUCH

16-018-21 - 16-018-23 22,5 cm, 8 3/4"



LANGENBECK

16-019-01 22,5 cm, 8 3/4"

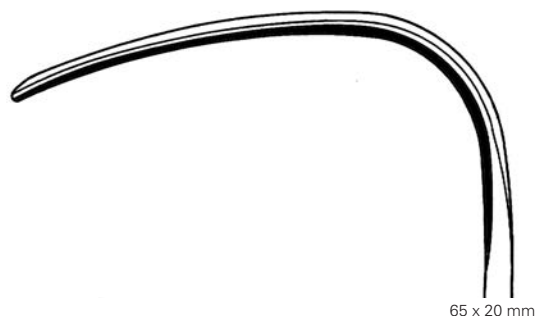

65 x 20 mm
16-020-01



55 x 20 mm
16-020-02



Kinnhalter
Chin retractor
Gancho de mentón
Guancio per mento

LANGENBECK

- 16-020-01** 21,0 cm, 8 1/4 "
- 16-020-02** 22,0 cm, 8 3/4 "

OBWEGESER

- 16-021-00** 16,5 cm, 6 1/2 "



80 x 16 mm
16-021-06

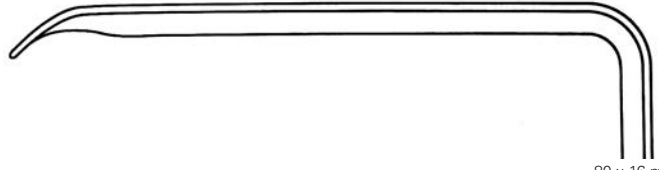

80 x 16 mm
16-021-17

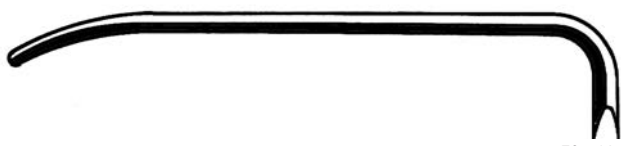

70 x 14 mm
16-021-05

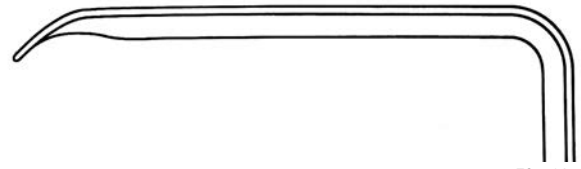

70 x 14 mm
16-021-16



55 x 12 mm
16-021-04



55 x 12 mm
16-021-15



42 x 11 mm
16-021-03



42 x 10 mm
16-021-14



31 x 10 mm
16-021-02

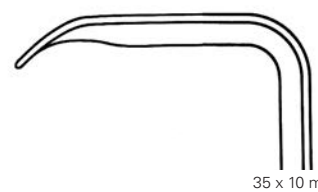

35 x 10 mm
16-021-13



25 x 7 mm
16-021-01

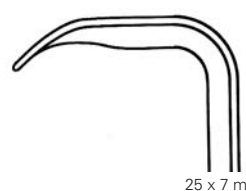

25 x 7 mm
16-021-12



16 x 5 mm
16-021-11



Weichteilhaken
Soft tissue retractors
Separadores para partes blandas
Divaricatori per tessuti molli

OBWEGESER

16-021-01 - 16-021-06 21,5 cm, 8 1/2"



Weichteilhaken
Soft tissue retractors
Separadores para partes blandas
Divaricatori per tessuti molli

OBWEGESER

16-021-11 - 16-021-17 24,0 cm, 9 1/2"

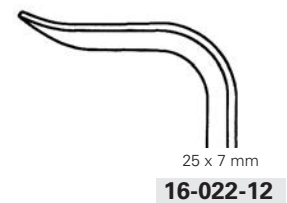
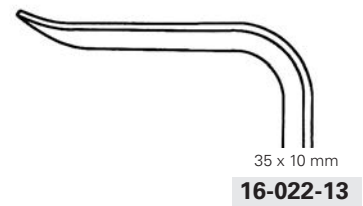
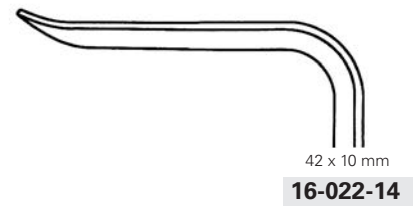
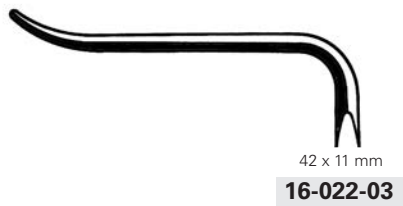
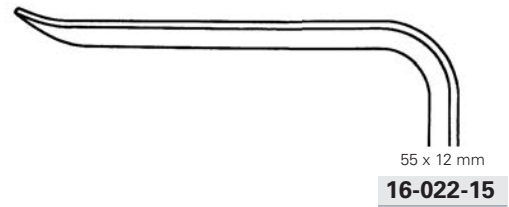
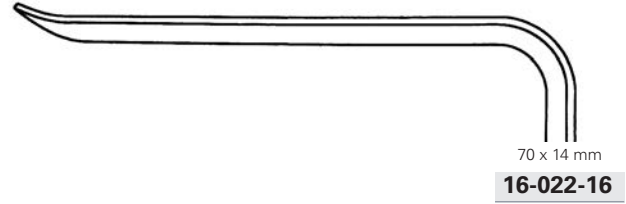
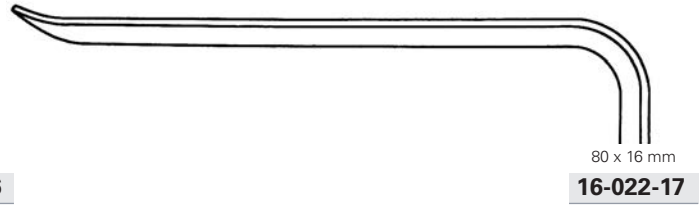
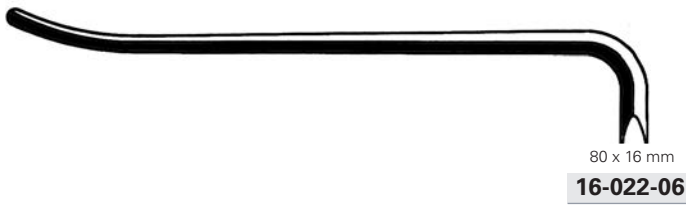

Weichteilhaken
Soft tissue retractors
Separadores para partes blandas
Divaricatori per tessuti molli



Weichteilhaken
Soft tissue retractors
Separadores para partes blandas
Divaricatori per tessuti molli



16 x 5 mm
16-022-11

OBWEGESER

16-022-01 - 16-022-06 21,5 cm, 8 1/2"

OBWEGESER

16-022-11 - 16-022-17 24,0 cm, 9 1/2"

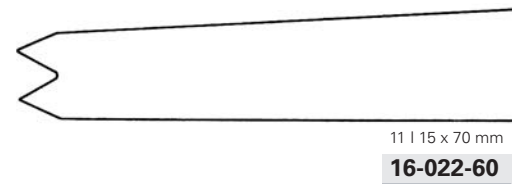
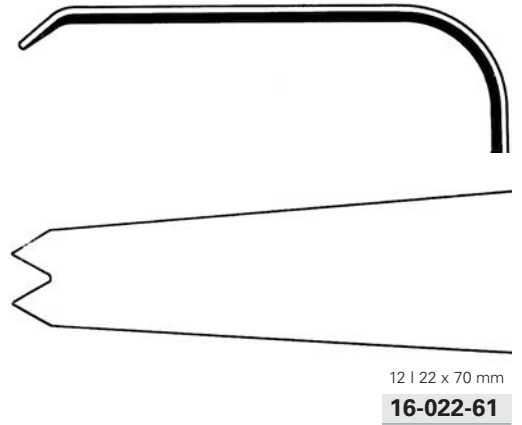
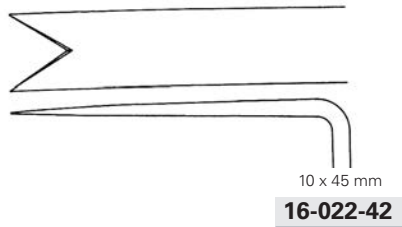
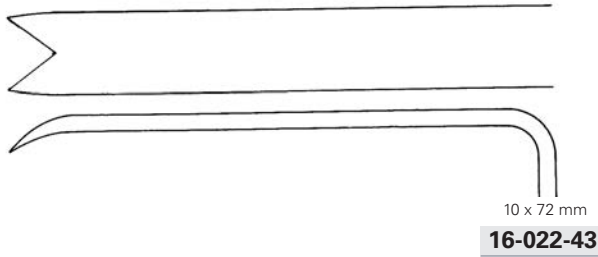

Ramushaken
Ramus retractors
Separadores para el ramo
Separatore per ramo

OBWEGESER

16-022-42 - 16-022-43 22,0 cm, 8 3/4"

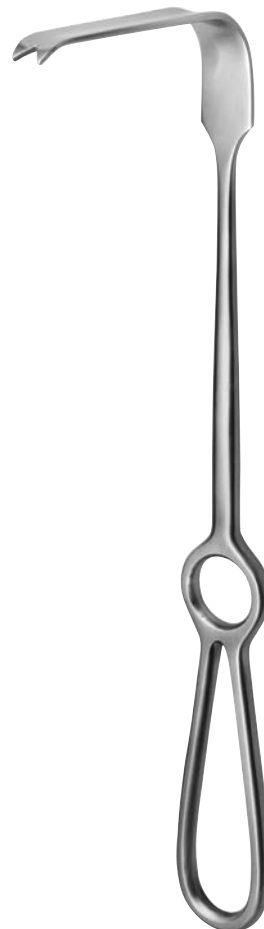

Ramushaken
Ramus retractors
Separadores para el ramo
Separatore per ramo

OBWEGESER

16-022-60 - 16-022-61 24,5 cm, 9 3/4"

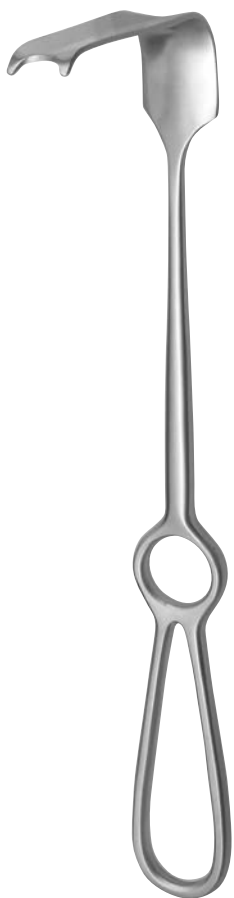
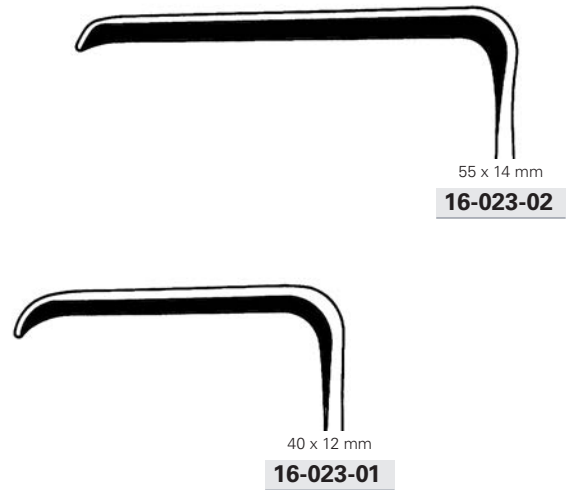
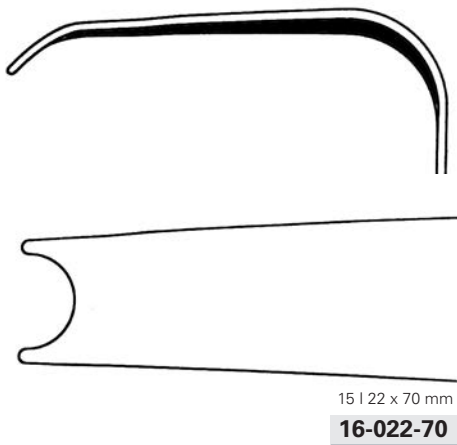

Weisheitszahnhaken
Third molar retractor
Separador para muela del juicio
Separatore per il dente del giudizio

OBWEGESER

16-022-70 24,0 cm, 9 ½ "



DOCKHORN

16-023-01 - 16-023-02 21,0 cm, 8 ¼ "

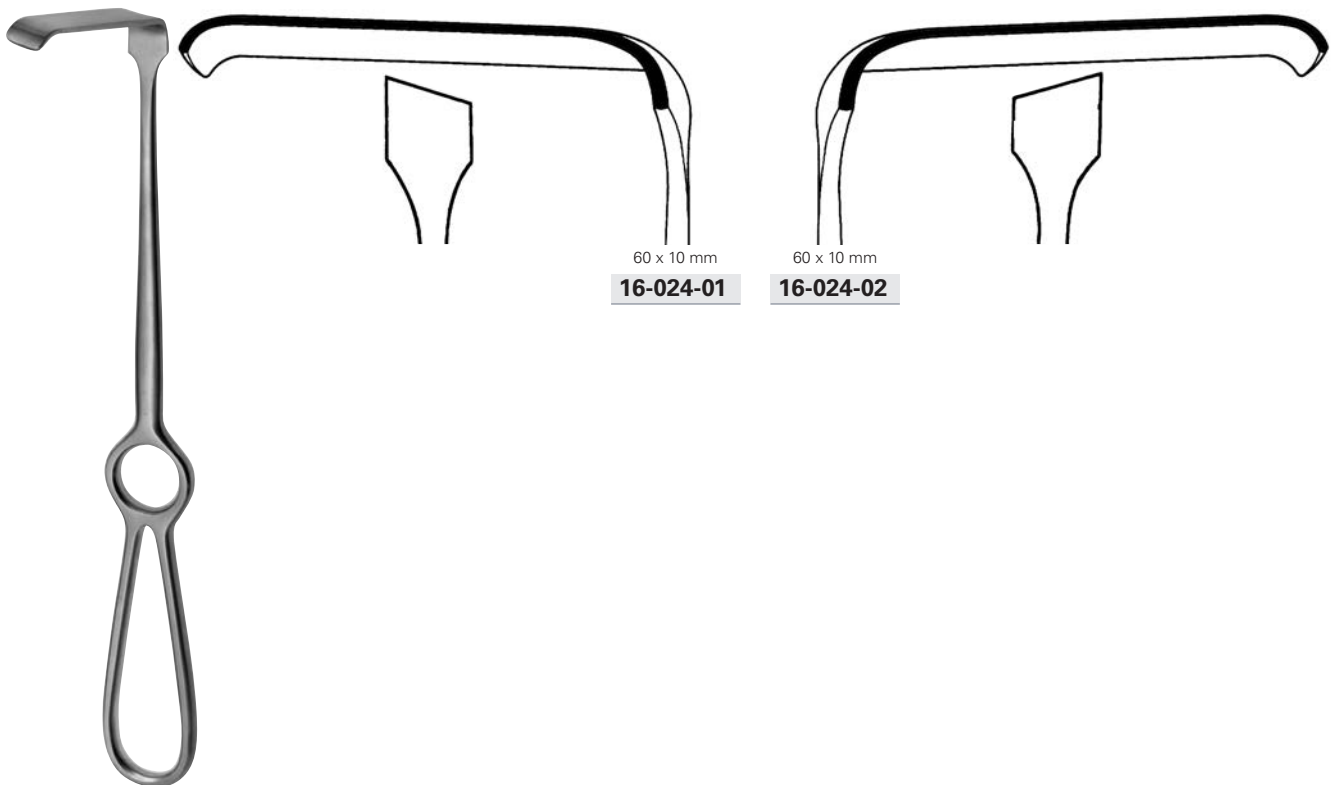

KIRSCH

16-024-01 - 16-024-02 21,0 cm, 8 ¼"

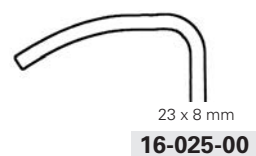
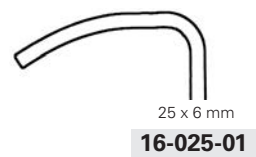
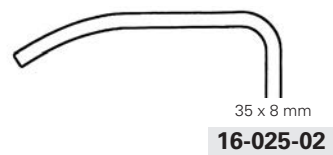
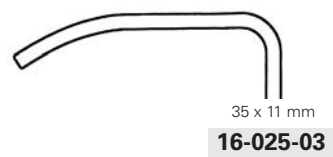
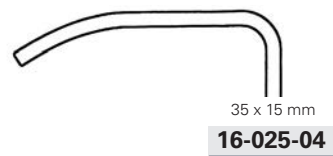
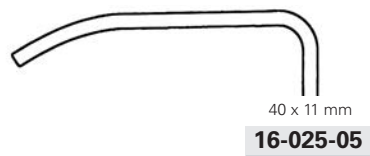
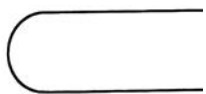
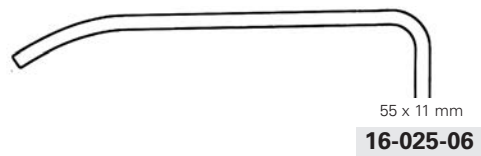
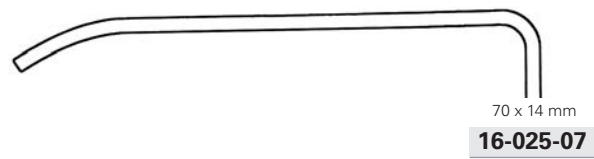
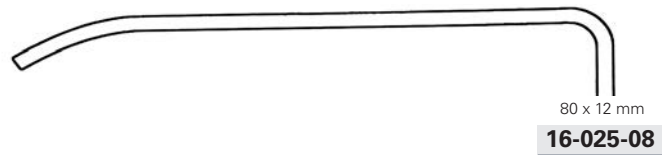
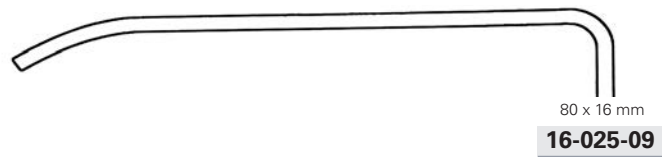

KOCHER-LANGENBECK

16-025-00 - 16-025-09 21,5 cm, 8 1/2"

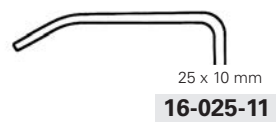
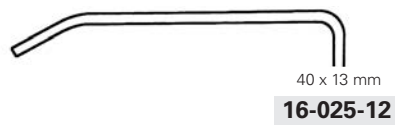
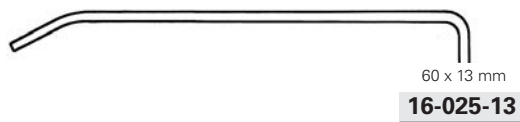
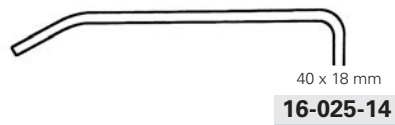
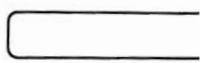

KOCHER-LANGENBECK

16-025-11 - 16-025-18 21,5 cm, 8 ½"

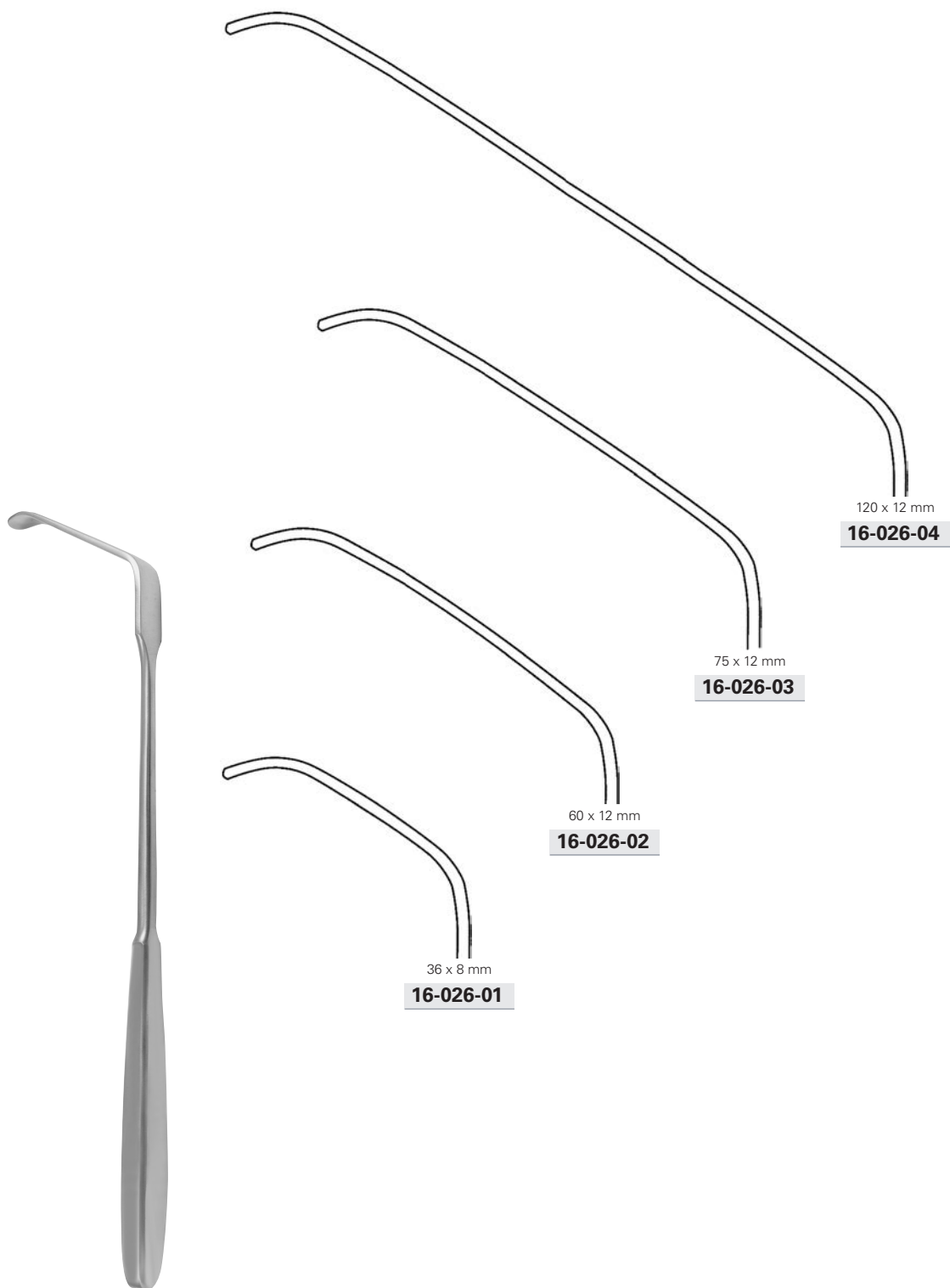

ZENKER

16-026-01	25,0 cm, 10"
16-026-02	26,0 cm, 10 1/2"
16-026-03	27,0 cm, 10 3/4"
16-026-04	29,0 cm, 11 1/2"



75 x 40 mm
16-027-05

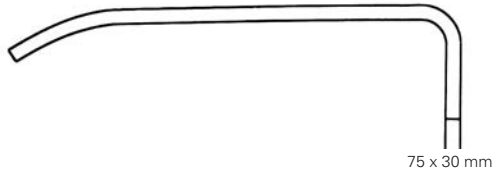

75 x 30 mm
16-027-04



60 x 25 mm
16-027-03

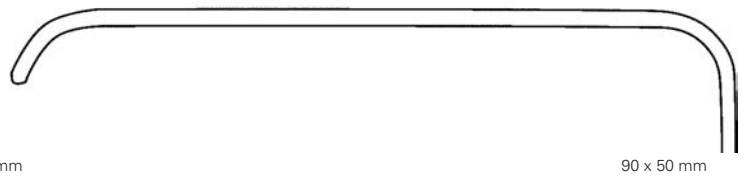

90 x 50 mm
16-028-01



60 x 20 mm
16-027-02



40 x 18 mm
16-027-01

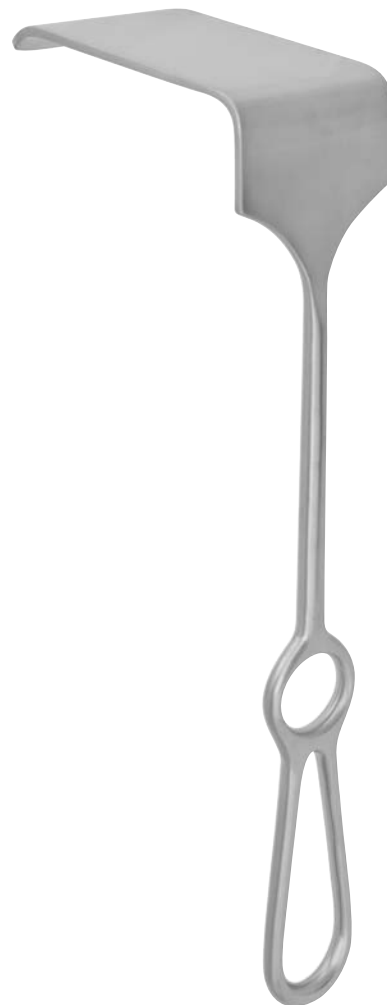

KOCHER

16-027-01 - 16-027-05 23,0 cm, 9"

MIKULICZ

16-028-01 26,0 cm, 10 1/2"



16-028-02	90 x 35 mm
16-028-03	120 x 50 mm
16-028-04	155 x 50 mm
16-028-05	180 x 50 mm

MIKULICZ

16-028-02 - 16-028-05 26,0 cm, 10 1/2"





SAUERBRUCH

16-029-01 - 16-029-03 22,5 cm, 8 3/4"

SAUERBRUCH

16-029-26 25,0 cm, 10"

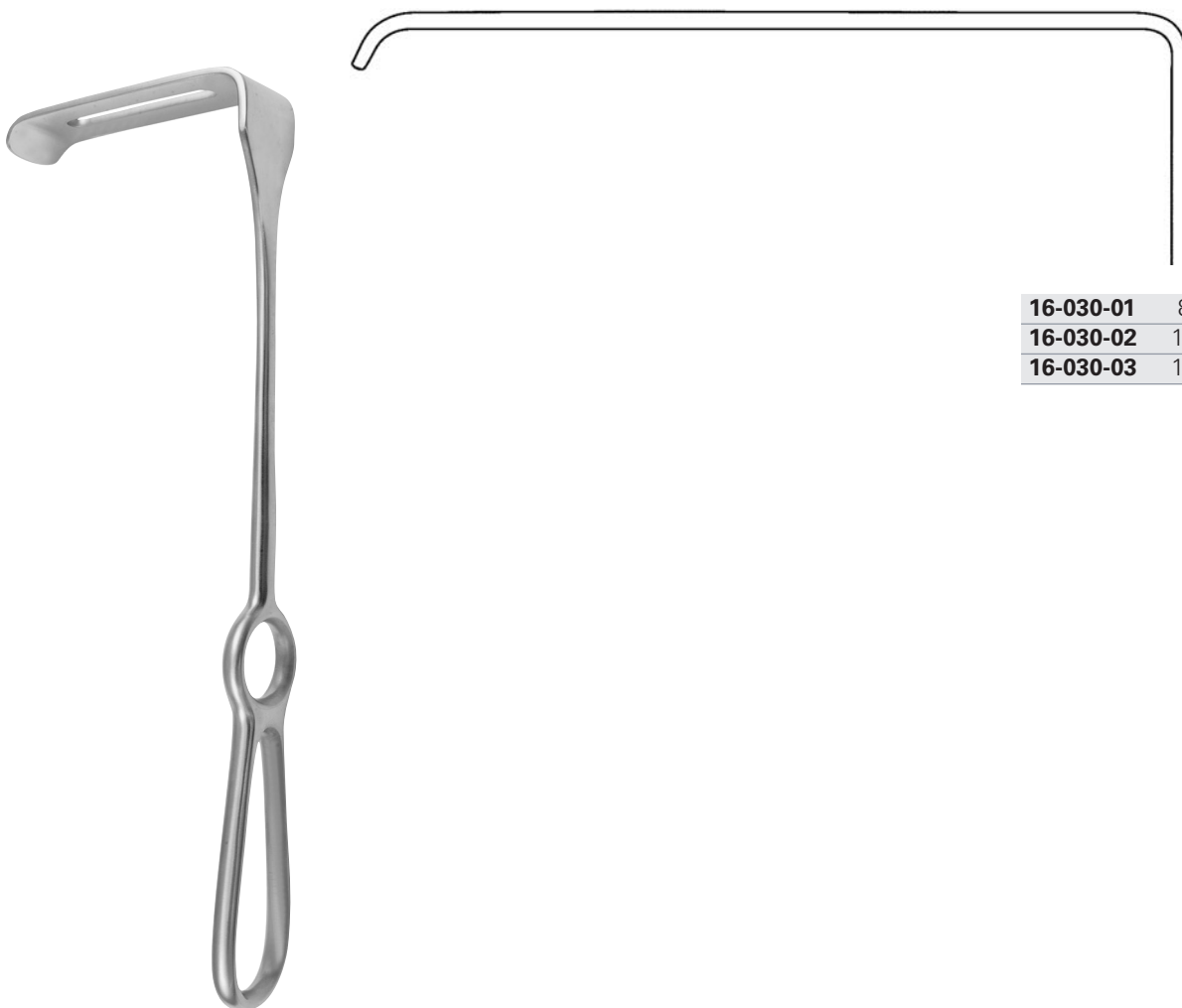

16-030-01	82 x 22 mm
16-030-02	115 x 38 mm
16-030-03	115 x 65 mm

CORYLLOS

16-030-01 - 16-030-03 24,0 cm, 9 ½"

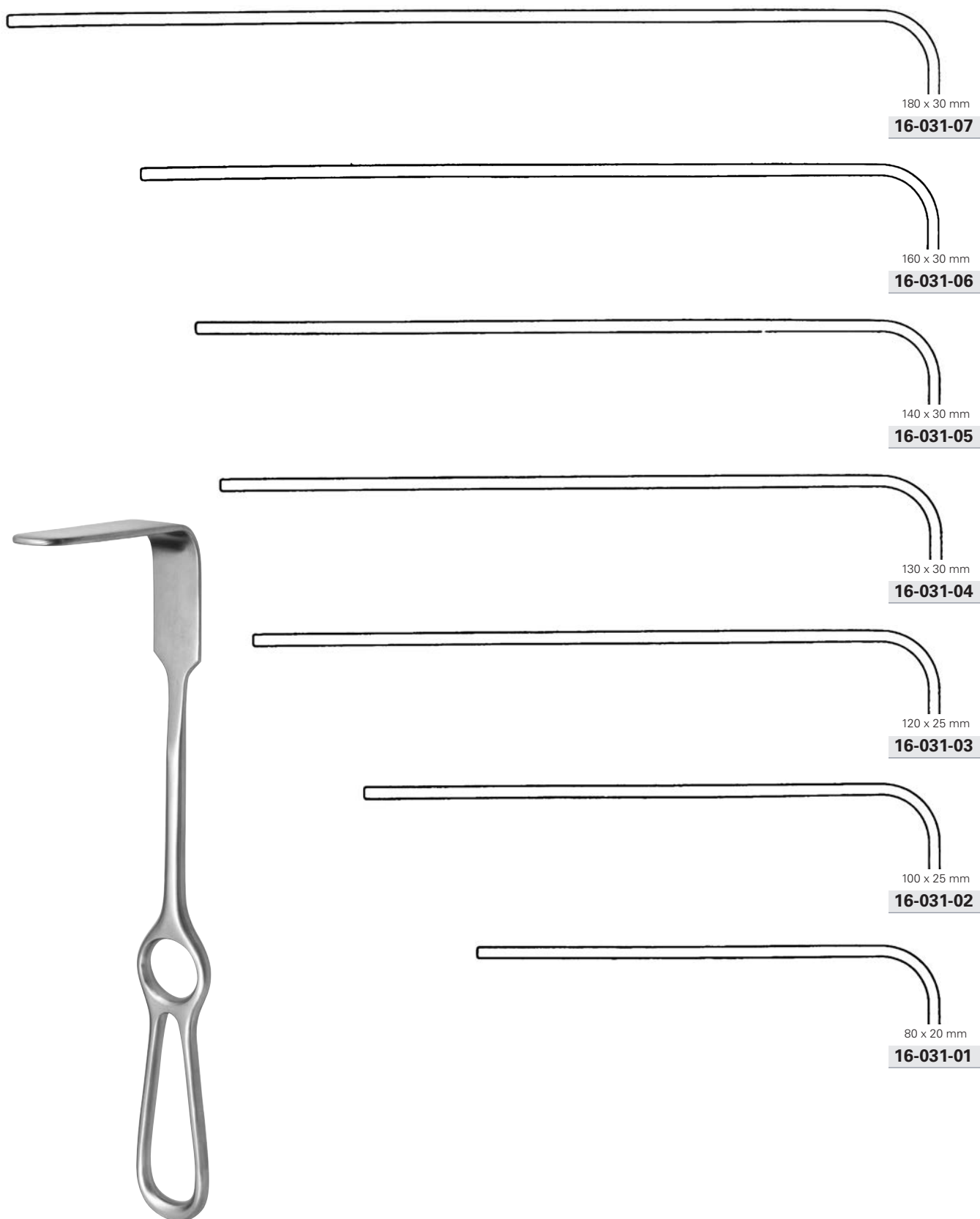

BRUNNER

16-031-01 - 16-031-07 25,5 cm, 10 "

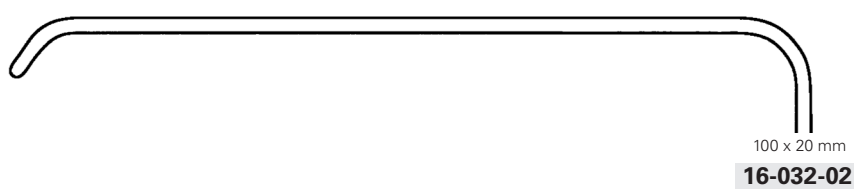
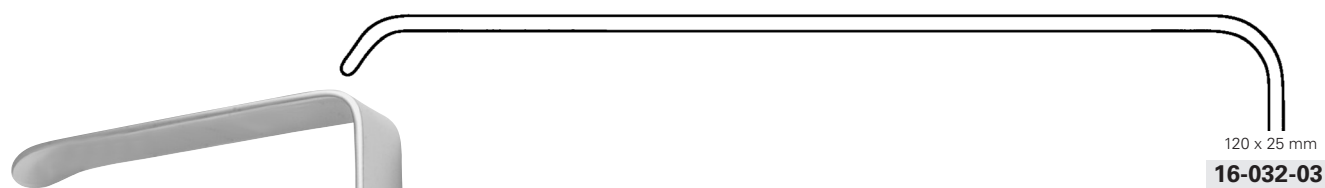
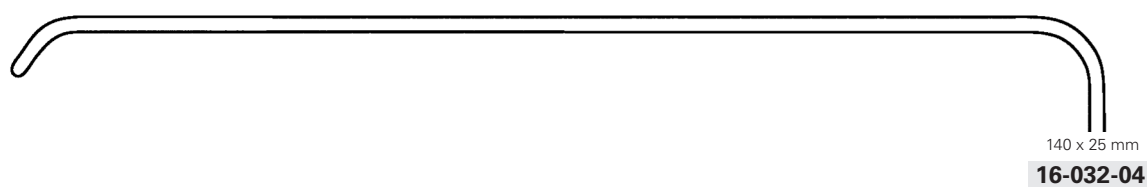
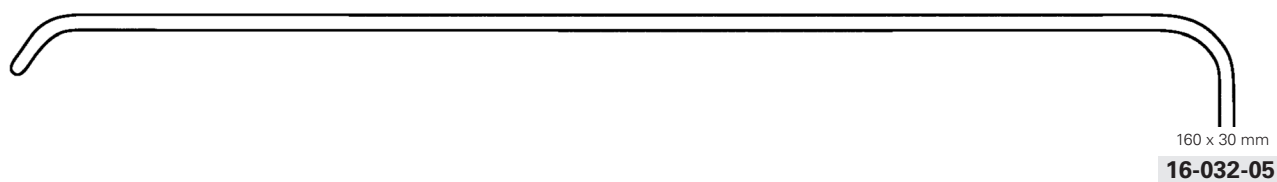

BRUNNER

16-032-01 - 16-032-06 25,0 cm, 10 "



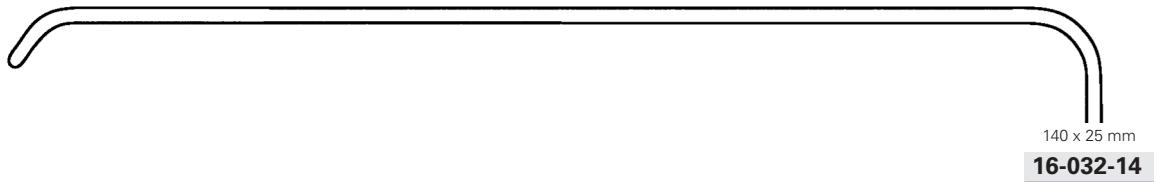
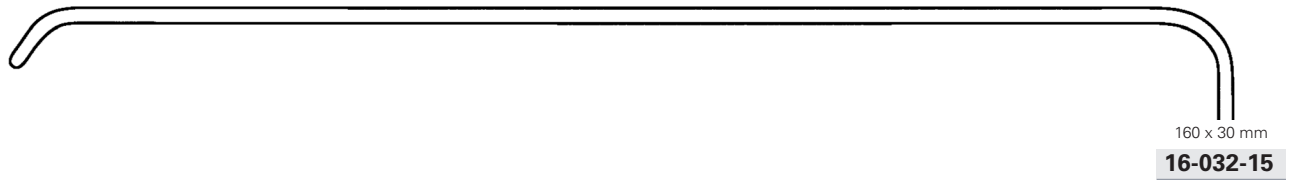

BRUNNER

16-032-11 - 16-032-16 25,0 cm, 10 "

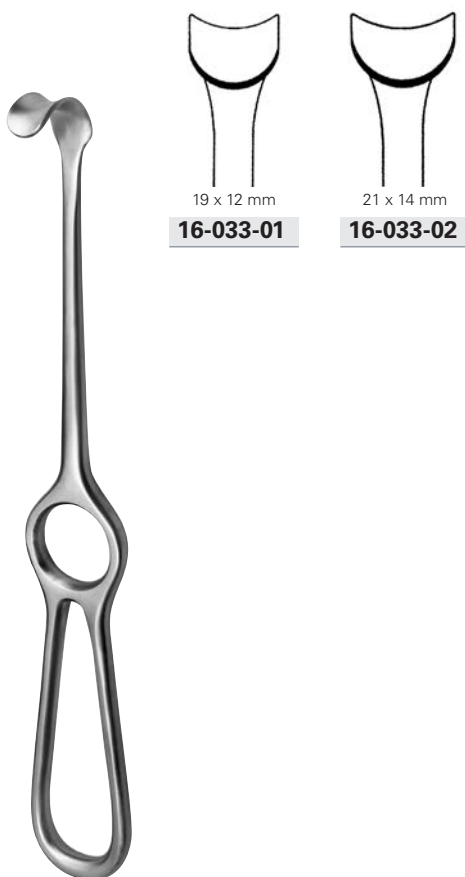

KOCHER

16-033-01 - 16-033-02 21,0 cm, 8 ¼"

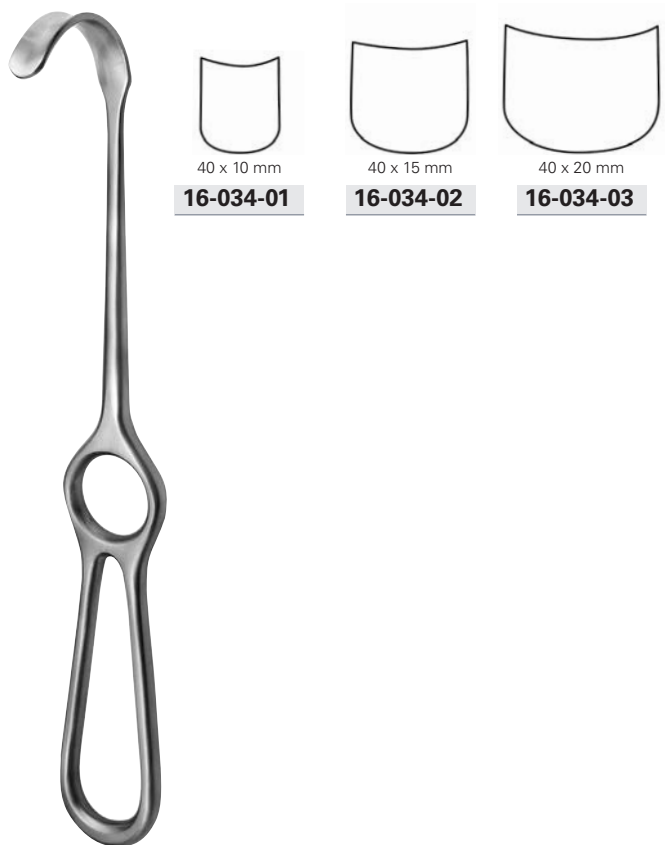

KOCHER

16-034-01 - 16-034-03 22,0 cm, 8 ¾"

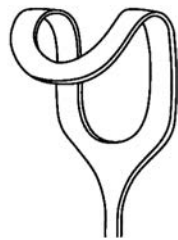

26 x 30 mm

16-035-03



20 x 22 mm

16-035-02



14 x 17 mm

16-035-01



MIDDELDORPF

16-035-01	21,5 cm, 8 1/2"
16-035-02	22,0 cm, 8 3/4"
16-035-03	23,5 cm, 9 1/2"



16-036-01	45 x 45 mm
16-036-02	45 x 50 mm
16-036-03	55 x 70 mm



MIDDELDORPF

16-036-01	25,5 cm, 10"
16-036-02	25,5 cm, 10"
16-036-03	25,5 cm, 10"



100 x 45 mm
16-037-28



16-037-40	70 x 40 mm
16-037-50	70 x 50 mm
16-037-65	70 x 65 mm

KUEMMEL

16-037-28 31,0 cm, 12 ¼"

MORRIS

16-037-40 - 16-037-65 24,0 cm, 9 ½"



53 x 80 mm

16-038-25

DOYEN

16-038-25 25,0 cm, 10 "



78 x 82 mm

16-038-26

DOYEN

16-038-26 26,0 cm, 10 ¼ "

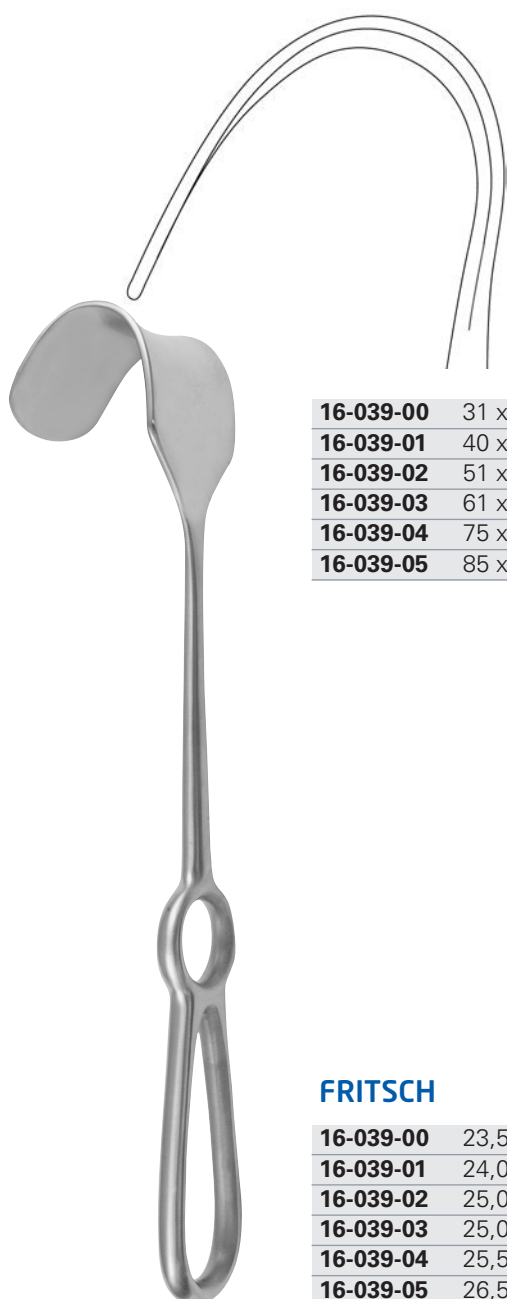

16-039-00	31 x 37 mm
16-039-01	40 x 38 mm
16-039-02	51 x 43 mm
16-039-03	61 x 49 mm
16-039-04	75 x 48 mm
16-039-05	85 x 65 mm

FRITSCH

16-039-00	23,5 cm, 9 ¼"
16-039-01	24,0 cm, 9 ½"
16-039-02	25,0 cm, 9 ¾"
16-039-03	25,0 cm, 9 ¾"
16-039-04	25,5 cm, 10"
16-039-05	26,5 cm, 10 ½"



58 x 64 mm
16-040-00

TUFFIER

16-040-00	21,5 cm, 8 ½"
------------------	---------------



70 x 25 mm
16-041-00

KOCHER

16-041-00 24,0 cm, 9 ½ "



16-041-01	80 x 45 mm
16-041-02	80 x 55 mm
16-041-03	80 x 65 mm

KOCHER

16-041-01 - 16-041-03 25,0 cm, 9 ¾ "

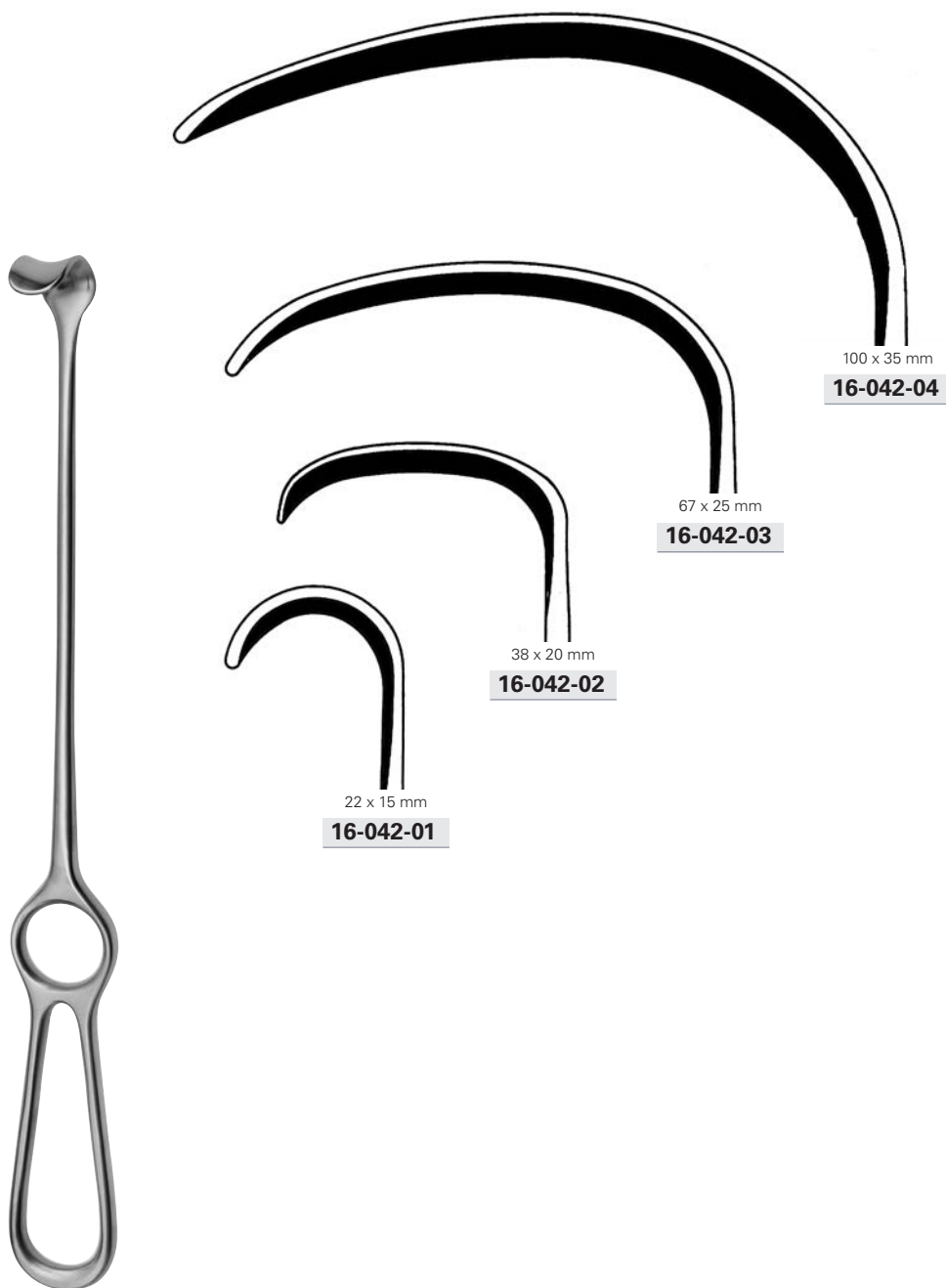

KOCHER-WAGNER

16-042-01 - 16-042-04 28,0 cm, 11 1/4"

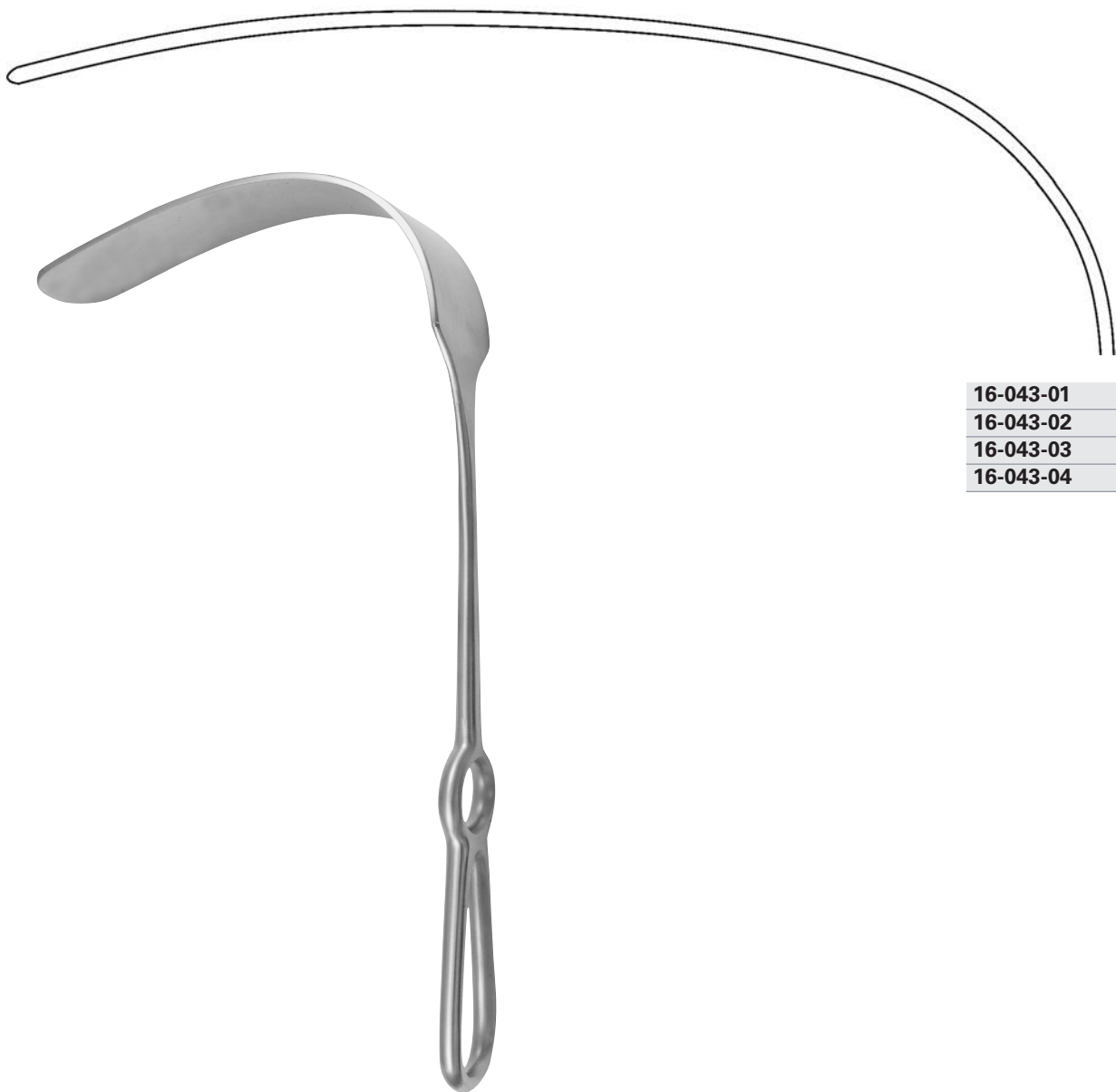

16-043-01	190 x 38 mm
16-043-02	190 x 57 mm
16-043-03	150 x 38 mm
16-043-04	150 x 57 mm

KELLY

16-043-01 - 16-043-04 27,0 cm, 10 ½"

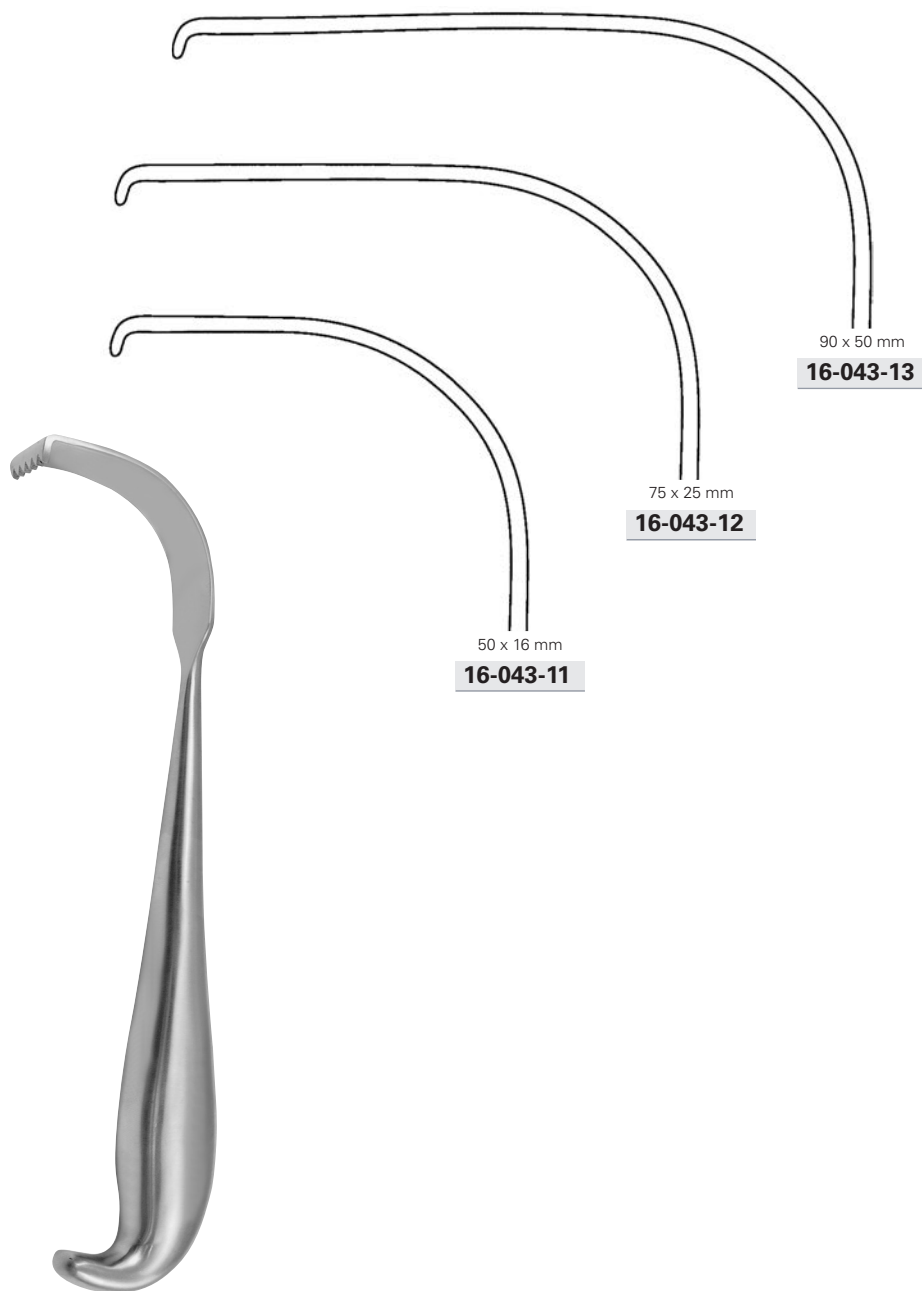

MEYERDING

16-043-11 - 16-043-13 23,0 cm, 9"



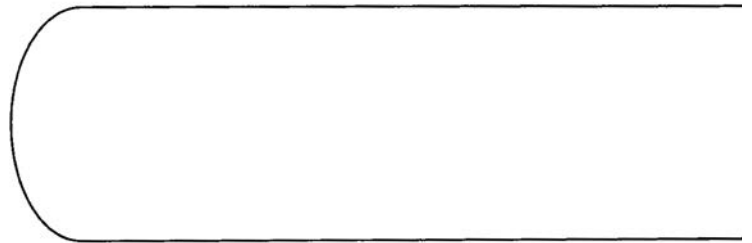

16-045-01	60 x 20 mm
16-045-02	80 x 30 mm
16-045-03	100 x 30 mm
16-045-04	120 x 30 mm
16-045-05	140 x 30 mm
16-045-06	140 x 40 mm
16-045-07	220 x 40 mm



16-044-01	97 x 29 mm
16-044-02	101 x 31 mm
16-044-03	127 x 52 mm



DOYEN-STILLE

16-044-01 - 16-044-03 26,0 cm, 10 ¼"

HOESEL

16-045-01 - 16-045-07 26,0 cm, 10 ¼"



16-046-01 127 x 40 mm
16-046-02 127 x 62 mm



175 x 64 mm

16-046-03



HARRINGTON

16-046-01 - 16-046-02 31,0 cm, 12 1/4"

HARRINGTON-PEMBERTON

16-046-03 29,5 cm, 11 3/4"

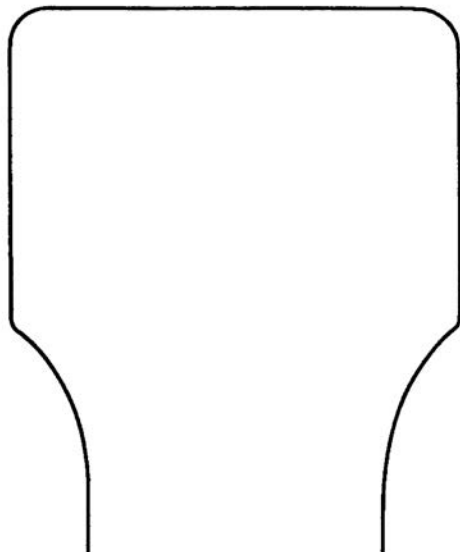

16-046-05



POLLOSON

16-046-05 29,0 cm, 11 1/2"

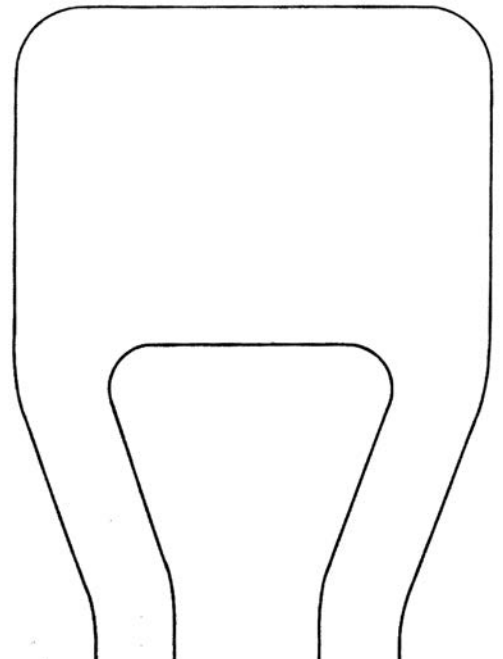

16-046-06



POLLOSON

16-046-06 26,0 cm, 10 1/4"

RICHARDSON-EASTMAN

16-047-00 SET



Fig. 1

16-047-01
28 x 20 mm

Fig. 2

16-047-02
49 x 38 mm

Fig. 1

16-047-01
36 x 28 mm

Fig. 2

16-047-02
63 x 49 mm

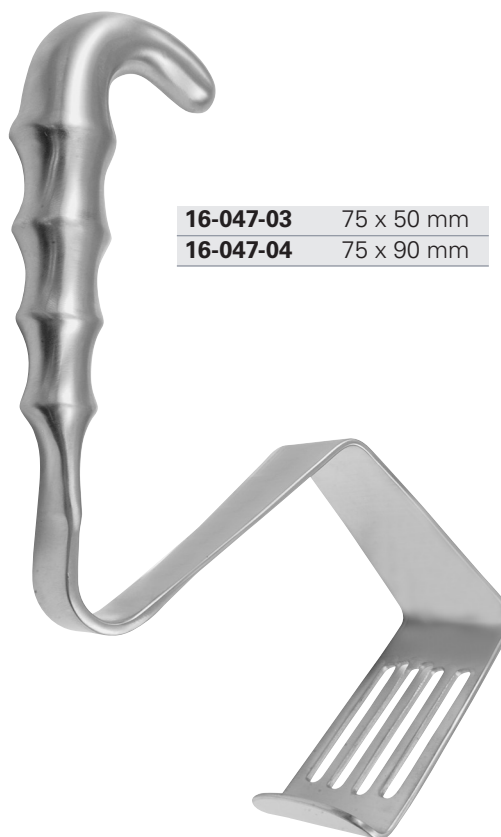

16-047-03 75 x 50 mm

16-047-04 75 x 90 mm

RICHARDSON-EASTMAN

16-047-01 26,0 cm, 10 1/4"

16-047-02 27,0 cm, 10 3/4"

DAVIDSON

16-047-03 19,0 cm, 7 1/2"

16-047-04 18,5 cm, 7 1/4"

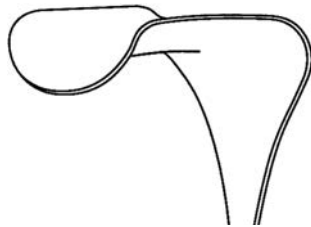

65 x 50 mm

16-047-15

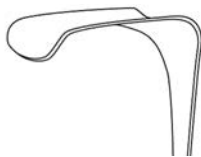

52 x 22 mm

16-047-14

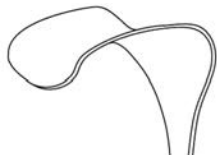

44 x 38 mm

16-047-13

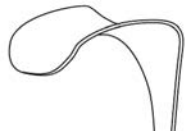

36 x 28 mm

16-047-12



28 x 20 mm

16-047-11

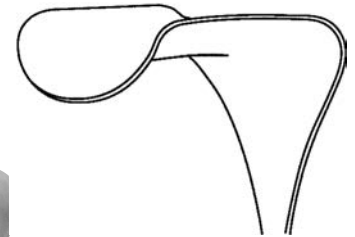

51 x 64 mm

16-047-20

RICHARDSON

16-047-11 - 16-047-15 24,0 cm, 9 ½"

KELLY

16-047-20 26,0 cm, 10 ¼"



KELLY

16-047-21 - 16-047-24 26,0 cm, 10 1/4"



95 x 20 mm

16-048-01

MOD. TUEBINGEN

16-048-01 26,0 cm, 10 ¼"



105 x 27 mm

16-048-02

MARTIN

16-048-02 25,0 cm, 10"



115 x 22 mm

16-048-03

115 x 26 mm

16-048-04



145 x 25 mm

16-048-05

145 x 25 mm

16-048-55

mit Kaltlicht
with cold light
con luz fría
con fibra ottica

SIMON

16-048-03 - 16-048-04 28,0 cm, 11 "

BRUNNER

16-048-05 - 16-048-55 24,0 cm, 9 ½ "

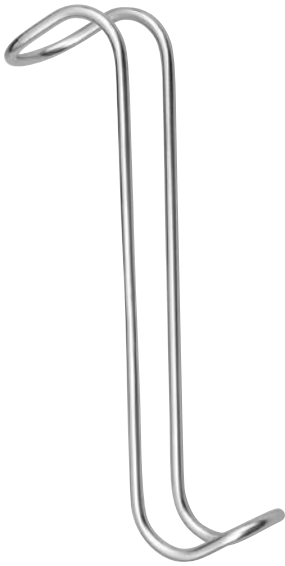

COLLIN-HARTMANN

16-049-01	14,0 cm, 5 1/2"
16-049-02	16,0 cm, 6 1/4"



ROUX

16-050-00	SET Fig. 1 - 3
16-050-01	14,0 cm, 5 1/2"
16-050-02	15,0 cm, 6"
16-050-03	17,0 cm, 6 3/4"

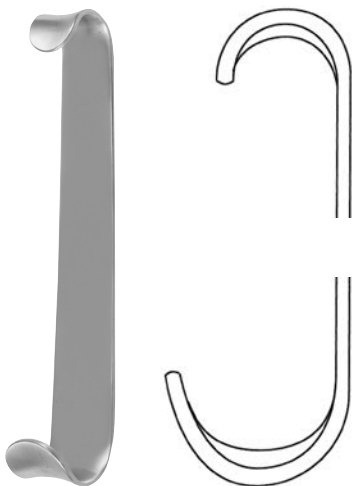
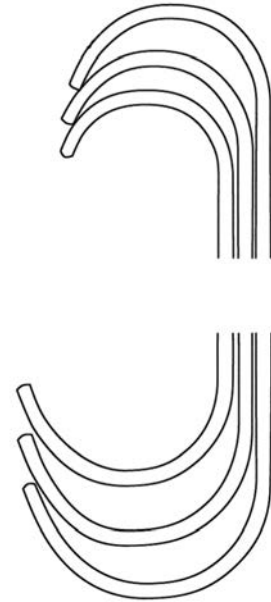

BABY-ROUX

16-051-01	12,5 cm, 5"
------------------	-------------

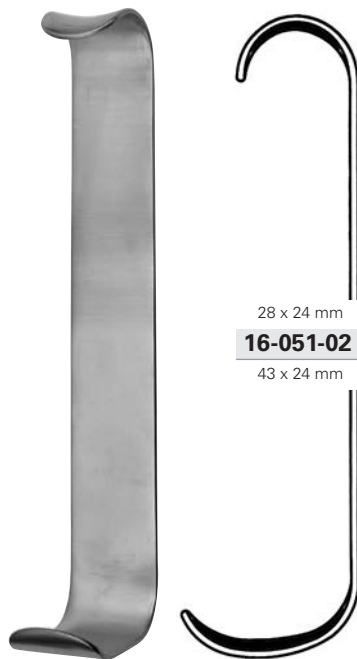

ROUX

16-051-02	17,0 cm, 6 3/4"
------------------	-----------------

28 x 24 mm
16-051-02
43 x 24 mm

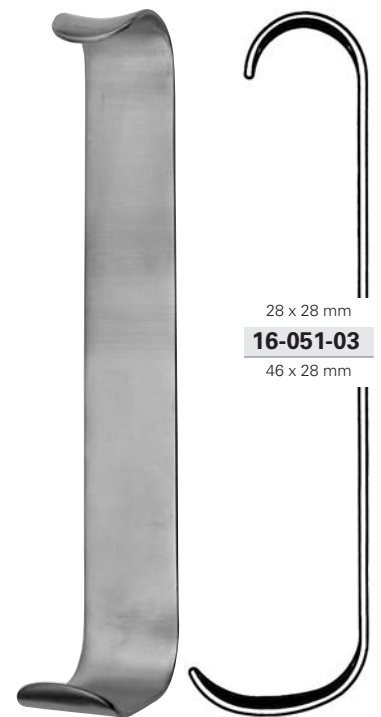

ROUX

16-051-03	19,0 cm, 7 1/2"
------------------	-----------------

28 x 28 mm
16-051-03
46 x 28 mm

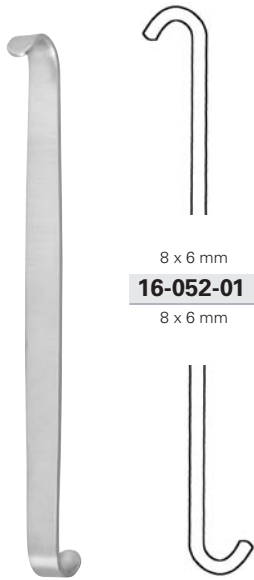

8 x 6 mm
16-052-01
8 x 6 mm

MINI-ROUX

16-052-01 14,5 cm, 5 3/4"



ROUX-MAGNUS

16-053-00	SET Fig. 1 - 3
16-053-01	14,0 cm, 5 1/2"
16-053-02	15,0 cm, 6"
16-053-03	17,0 cm, 6 3/4"



PARKER

16-054-00 17,5 cm, 7"

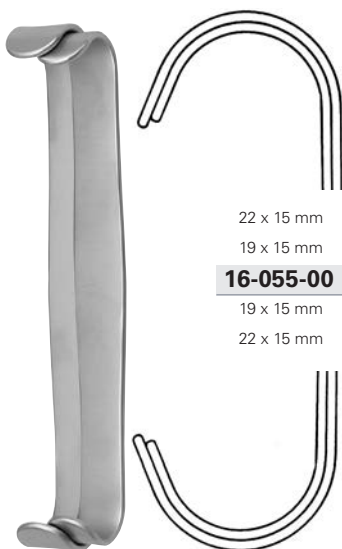

22 x 15 mm
19 x 15 mm
16-055-00
19 x 15 mm
22 x 15 mm

PARKER-BABY

16-055-00 13,5 cm, 5 1/4"

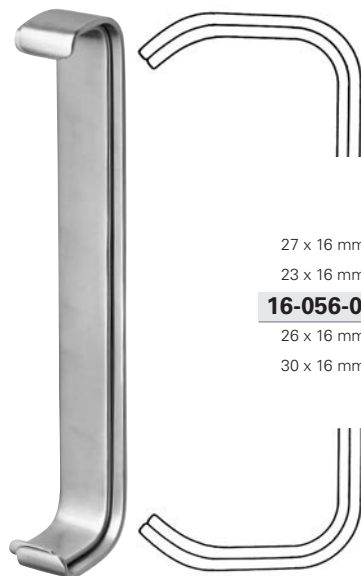

27 x 16 mm
23 x 16 mm
16-056-00
26 x 16 mm
30 x 16 mm

FARABEU

16-056-00 15,0 cm, 6"



30 x 10 mm
26 x 10 mm
16-057-00
30 x 13 mm
34 x 13 mm

FARABEU

16-057-00 11,5 cm, 4 1/2"

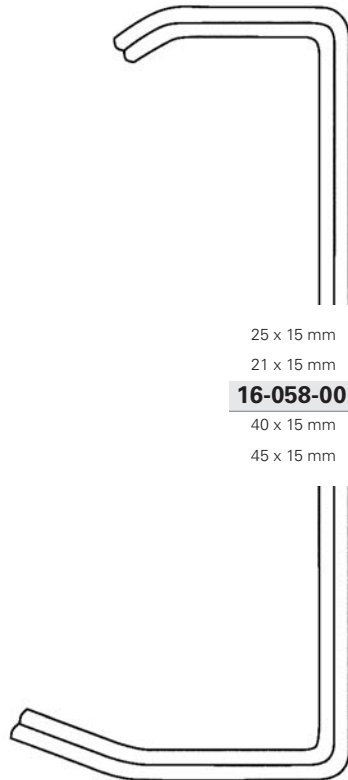

25 x 15 mm
21 x 15 mm
16-058-00
40 x 15 mm
45 x 15 mm

PARKER-LANGENBECK

16-058-00 21,0 cm, 8 ½"

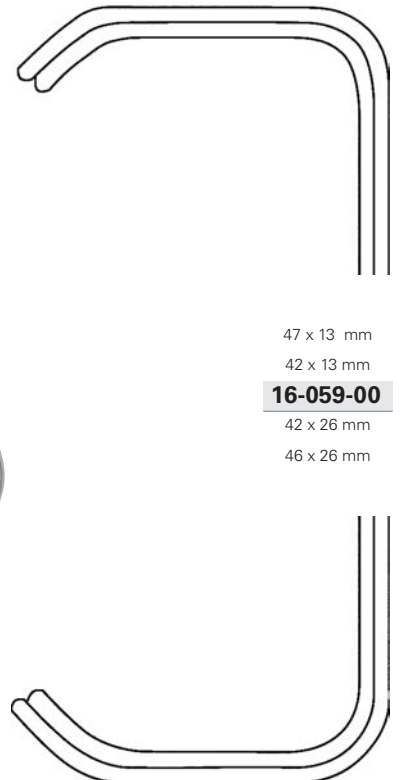

47 x 13 mm
42 x 13 mm
16-059-00
42 x 26 mm
46 x 26 mm

MATHIEU

16-059-00 20,0 cm, 8"



68 x 24 mm
72 x 24 mm
16-060-00
25 x 24 mm
21 x 24 mm

PARKER-MOTT

16-060-00 16,0 cm, 6 ½"



40 x 40 mm
16-061-19
30 x 30 mm

GOELET

16-061-19 19,0 cm, 7 ½"



16 x 3 mm
16-060-15
6 x 3 mm

RAGNELL

16-060-15 15,0 cm, 6 "

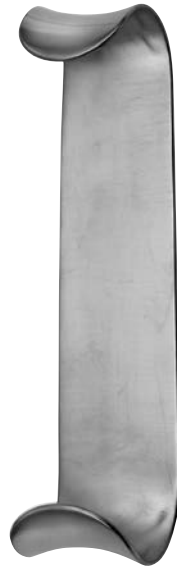

KILNER

16-060-30 - 16-060-35 15,0 cm, 6 "

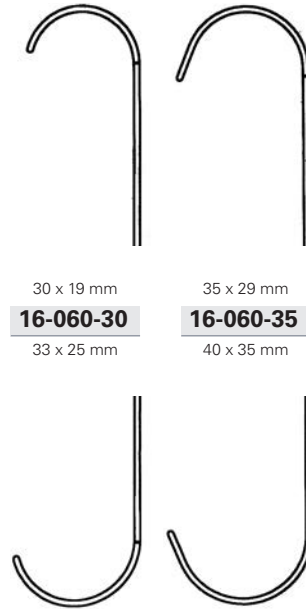

30 x 19 mm
16-060-30
33 x 25 mm

35 x 29 mm
16-060-35
40 x 35 mm

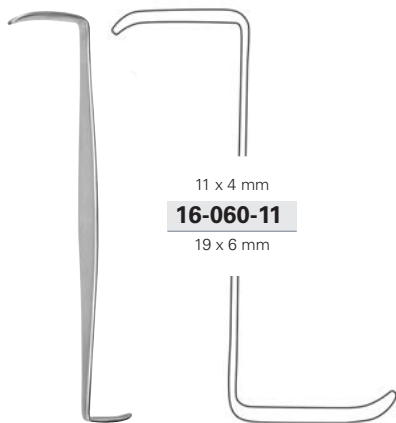

11 x 4 mm
16-060-11
19 x 6 mm

CRILE

16-060-11 11,0 cm, 4 3/8 "

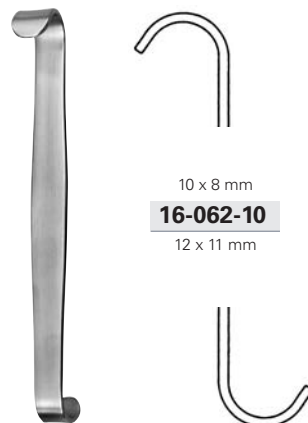

10 x 8 mm
16-062-10
12 x 11 mm

LUER

16-062-10 11,0 cm, 4 3/8 "

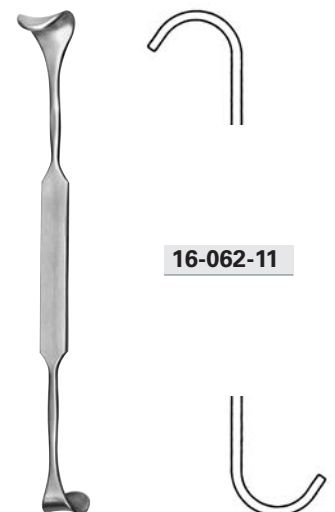

16-062-11

ROSE

16-062-11 13,5 cm, 5 1/4 "



COLLIN

16-063-00 15,0 cm, 6"

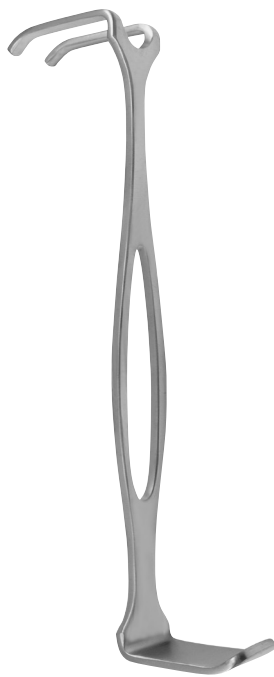

CZERNY

16-063-18 17,5 cm, 7"

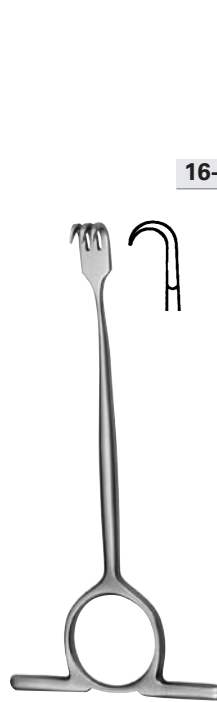

WILLIGER

16-064-01 - 16-064-03 12,0 cm, 4 3/4"



16-064-01



16-064-02



16-064-03

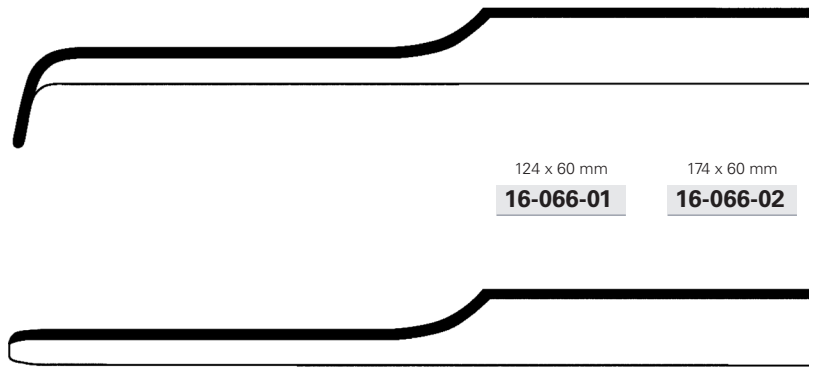

124 x 60 mm

16-066-01

174 x 60 mm

16-066-02

178 x 60 mm

16-066-03

ST. MARKS

16-066-01 29,0 cm, 11 1/2"

16-066-02 - 16-066-03 33,0 cm, 13"



REVERDIN

16-071-28 28,0 cm, 11 "



biegsam
malleable
maleable
malleabile

16-072-01	330 x 20 mm
16-072-02	330 x 25 mm
16-072-03	330 x 30 mm
16-072-04	330 x 40 mm
16-072-05	330 x 50 mm



biegsam
malleable
maleable
malleabile

HABERER

16-073-01	200 x 17 25 mm
16-073-02	280 x 25 30 mm
16-073-03	300 x 47 45 mm
16-073-04	300 x 40 50 mm



biegsam
malleable
maleable
malleabile

16-074-01	200 x 6 mm
16-074-02	200 x 8 mm
16-074-03	200 x 10 mm
16-074-04	200 x 12 mm
16-074-05	200 x 17 mm
16-074-06	200 x 25 mm
16-074-07	250 x 25 mm

mit Kaltlicht und Absaugung
with cold light and suction
con luz fría y aspiración
con fibra ottica e aspirazione



16-067-00	80 x 16 mm
16-067-01	90 x 24 mm
16-067-02	90 x 30 mm
16-067-03	100 x 24 mm
16-067-04	120 x 25 mm
16-067-05	120 x 30 mm
16-067-06	150 x 25 mm
16-067-07	150 x 30 mm
16-067-08	150 x 36 mm
16-067-09	170 x 40 mm
16-067-10	190 x 30 mm

ohne Kaltlicht und Absaugung
without cold light and suction
sin luz fría y aspiración
senza fibra ottica e aspirazione



16-067-60	80 x 16 mm
16-067-61	90 x 24 mm
16-067-62	90 x 30 mm
16-067-63	100 x 24 mm
16-067-64	120 x 25 mm
16-067-65	120 x 30 mm
16-067-66	150 x 25 mm
16-067-67	150 x 30 mm
16-067-68	150 x 36 mm
16-067-69	170 x 40 mm
16-067-70	190 x 30 mm

mit Kaltlicht und Absaugung
with cold light and suction
con luz fría y aspiración
con fibra ottica e aspirazione



16-068-00	80 x 16 mm
16-068-01	90 x 24 mm
16-068-02	90 x 30 mm
16-068-03	100 x 24 mm
16-068-04	120 x 25 mm
16-068-05	120 x 30 mm
16-068-06	150 x 25 mm
16-068-07	150 x 30 mm
16-068-08	150 x 36 mm
16-068-09	170 x 40 mm
16-068-10	190 x 30 mm

ohne Kaltlicht und Absaugung
without cold light and suction
sin luz fría y aspiración
senza fibra ottica e aspirazione



16-068-60	80 x 16 mm
16-068-61	90 x 24 mm
16-068-62	90 x 30 mm
16-068-63	100 x 24 mm
16-068-64	120 x 25 mm
16-068-65	120 x 30 mm
16-068-66	150 x 25 mm
16-068-67	150 x 30 mm
16-068-68	150 x 36 mm
16-068-69	170 x 40 mm
16-068-70	190 x 30 mm

mit Kaltlicht und Absaugung
with cold light and suction
con luz fría y aspiración
con fibra ottica e aspirazione



16-069-00	80 x 16 mm
16-069-01	100 x 24 mm
16-069-02	120 x 25 mm
16-069-03	120 x 30 mm
16-069-04	150 x 25 mm
16-069-05	150 x 30 mm
16-069-06	170 x 40 mm
16-069-07	180 x 25 mm

ohne Kaltlicht und Absaugung
without cold light and suction
sin luz fría y aspiración
senza fibra ottica e aspirazione



16-069-60	80 x 16 mm
16-069-61	100 x 24 mm
16-069-62	120 x 25 mm
16-069-63	120 x 30 mm
16-069-64	150 x 25 mm
16-069-65	150 x 30 mm
16-069-66	170 x 40 mm
16-069-67	180 x 25 mm

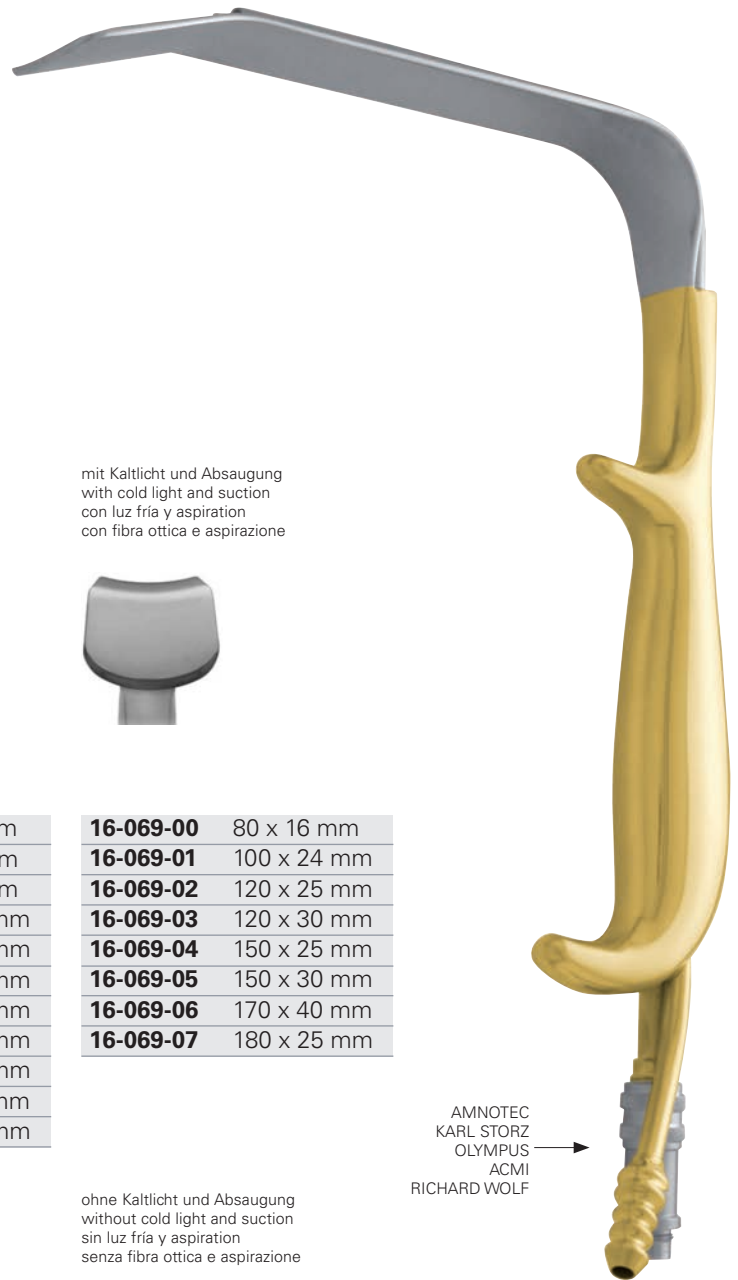

AMNOTEC
KARL STORZ
OLYMPUS
ACMI
RICHARD WOLF



46 mm
16-076-45

LERICHE

16-076-45 25,5 cm, 10"



60 mm
16-076-60

LERICHE

16-076-60 27,5 cm, 10³/₄"



KUEMMEL

16-077-46 28,5 cm, 11 1/4"



KOERTE

16-078-46 30,0 cm, 11 3/4"

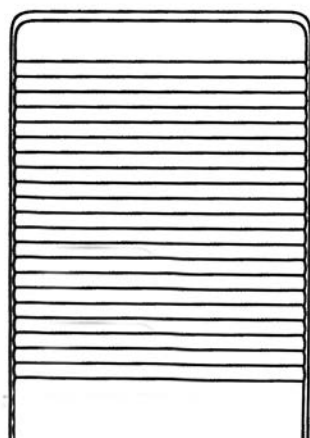

40 mm

16-079-40



30 mm

16-079-30



20 mm

16-079-20



16-080-30	30 mm
16-080-40	40 mm
16-080-50	50 mm
16-080-60	60 mm
16-080-70	70 mm

biegsam
malleable
malleable
malleabile

KADER

16-079-20 - 16-079-40 28,0 cm, 11"

16-080-30 - 16-080-70 41,0 cm, 16"

19,0 mm



DEAVER **Fig. 1**
16-081-01 18,0 cm, 7 "

22,0 mm



DEAVER **Fig. 2**
16-081-02 21,5 cm, 8 ½ "

25,0 mm

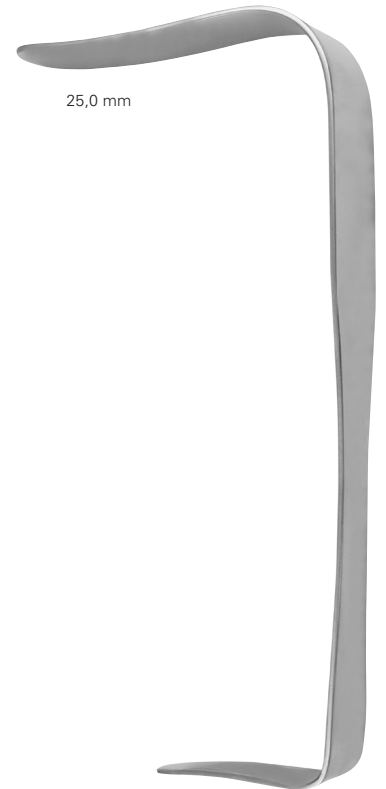

DEAVER **Fig. 3**
16-081-03 25,0 cm, 9 ¾ "

25,0 mm



DEAVER **Fig. 4**
16-081-04 30,0 cm, 11 ¾ "

25,0 mm



DEAVER **Fig. 5**
16-081-05 33,0 cm, 13 "

25,0 mm

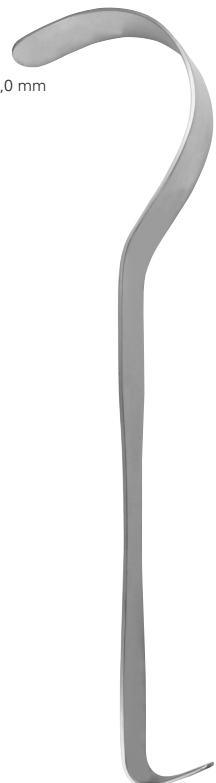

DEAVER **Fig. 6**
16-081-06 36,0 cm, 14 ¼ "



38,0 mm

DEAVER Fig. 7

16-081-07 30,0 cm, 11 ³/₄"



50,0 mm

DEAVER Fig. 8

16-081-08 31,0 cm, 12 ¹/₄"



75,0 mm

DEAVER Fig. 9

16-081-09 32,0 cm, 12 ¹/₂"



16-082-01	Fig. 1 25 mm
16-082-02	Fig. 2 38 mm
16-082-03	Fig. 3 50 mm
16-082-04	Fig. 4 75 mm
16-082-05	Fig. 5 100 mm

DEAVER

16-082-01 - 16-082-05 31,0 cm, 12 ¹/₄"



16-100-01

scharf
sharp
agudo
acuto



VICKERS

16-100-01 18,5 cm, 7 1/4"



16-100-02

scharf
sharp
agudo
acuto



VICKERS

16-100-02 17,0 cm, 6 3/4"



16-100-03

stumpf
blunt
romo
smusso



VICKERS

16-100-03 17,0 cm, 6 3/4"

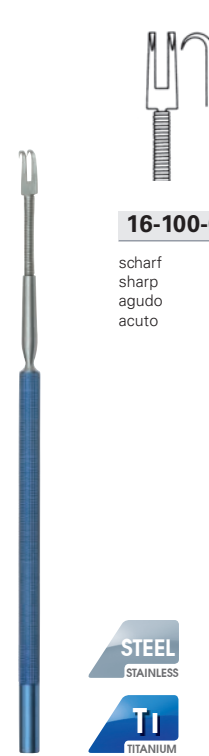

16-100-04

scharf
sharp
agudo
acuto



VICKERS

16-100-04 16,0 cm, 6 3/4"



16-100-05

scharf
sharp
agudo
acuto



VICKERS

16-100-05 16,0 cm, 6 3/4"

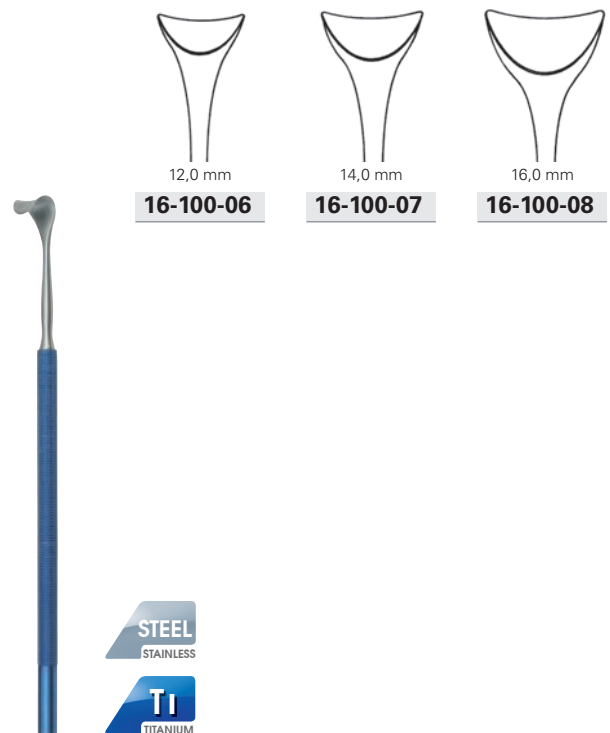

16-100-06

12,0 mm

16-100-07

14,0 mm

16-100-08

16,0 mm



VICKERS

16-100-06 - 16-100-08 14,0 cm, 5 1/2"

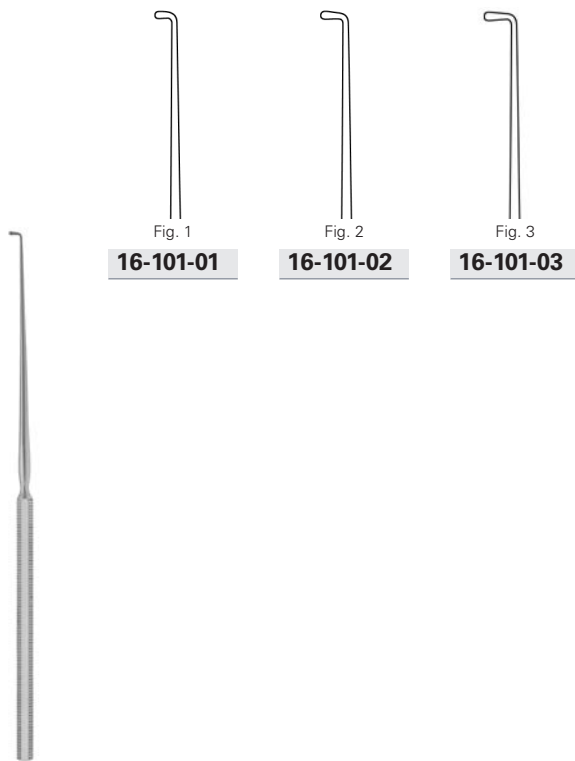

Fig. 1
16-101-01

Fig. 2
16-101-02

Fig. 3
16-101-03

LUCAE

16-101-01 - 16-101-03 14,0 cm, 5 1/2"

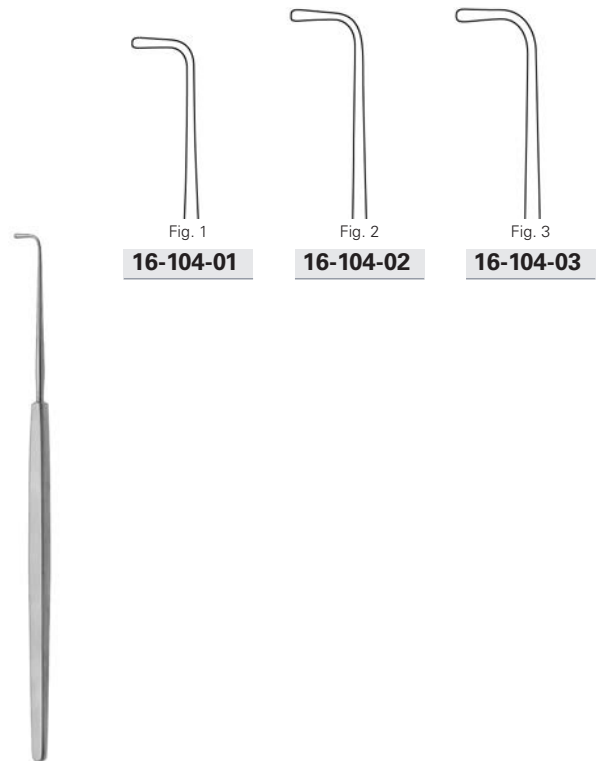

Fig. 1
16-104-01

Fig. 2
16-104-02

Fig. 3
16-104-03

GRAEFE

16-104-01 13,0 cm, 5 1/8"

16-104-02 - 16-104-03 14,0 cm, 5 1/2"

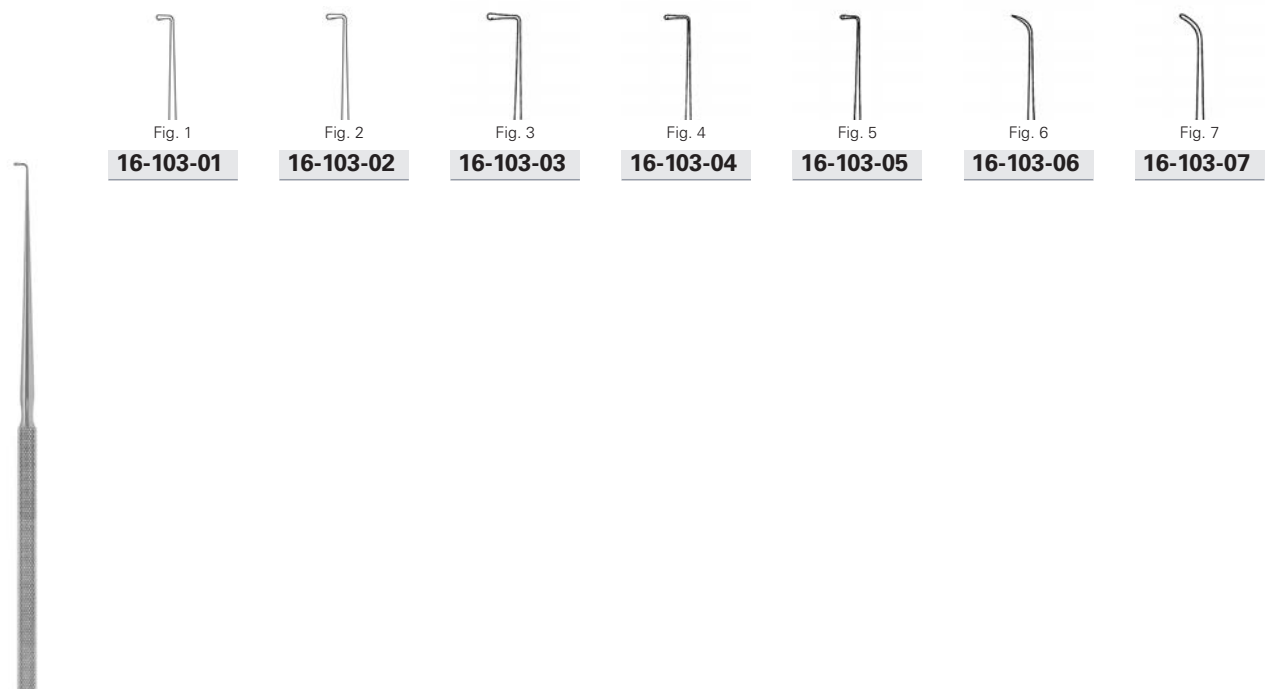

Fig. 1
16-103-01

Fig. 2
16-103-02

Fig. 3
16-103-03

Fig. 4
16-103-04

Fig. 5
16-103-05

Fig. 6
16-103-06

Fig. 7
16-103-07

WAGENER

16-103-01 - 16-103-07 14,0 cm, 5 1/2"

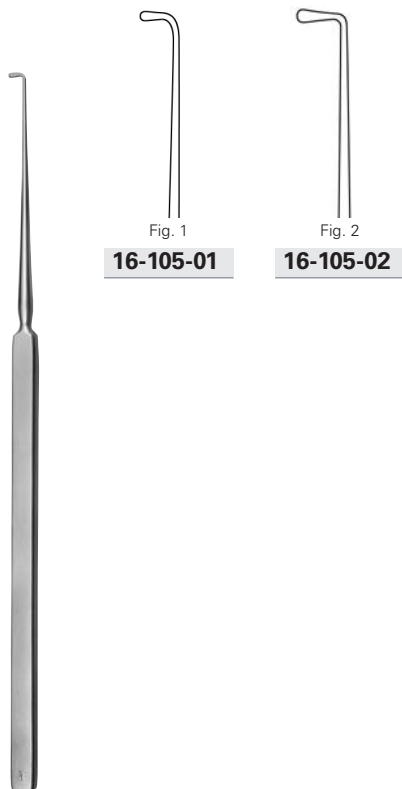

16-105-01

Fig. 1

16-105-02

Fig. 2

CUSHING

16-105-01 - 16-105-02 19,0 cm, 7 1/2 "

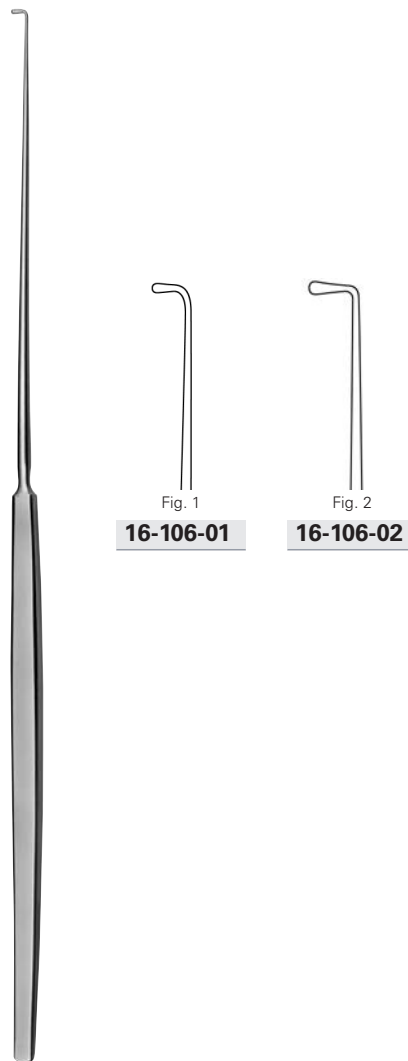

16-106-01

Fig. 1

16-106-02

Fig. 2

CUSHING

16-106-01 - 16-106-02 28,0 cm, 11 "



16-107-01

CRILE

16-107-01 20,0 cm, 8 "



16-107-17

BROM

16-107-17 17,0 cm, 6 3/4"



16-108-01

scharf
sharp
agudo
acuto



16-109-01

stumpf
blunt
romo
smusso



GRAEFE

16-108-01 - 16-109-01 15,0 cm, 6"



Fig. 1

16-110-01

scharf
sharp
agudo
acuto



Fig. 2

16-110-02

scharf
sharp
agudo
acuto



Fig. 3

16-110-03

scharf
sharp
agudo
acuto



Fig. 4

16-110-04

scharf
sharp
agudo
acuto



16-111-01

scharf
sharp
agudo
acuto



90°

16-111-02

scharf
sharp
agudo
acuto



O'CONNOR

16-111-01 - 16-111-02 16,0 cm, 6 1/4"

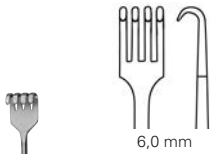

16-111-04

stumpf
blunt
romo
smusso



KNAPP

16-111-04 16,0 cm, 6 1/4"



6,0 mm

16-112-01

16-112-01

scharf
sharp
agudo
acuto

16-112-02

scharf
sharp
agudo
acuto



GUTHRIE

16-112-01 - 16-112-02 16,0 cm, 6 1/4"



16-112-03

scharf
sharp
agudo
acuto



16-112-04

scharf
sharp
agudo
acuto



ROLLET

16-112-03 - 16-112-04 13,0 cm, 5 1/8"



16-114-01

scharf
sharp
agudo
acuto

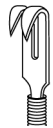

16-114-02

scharf
sharp
agudo
acuto



16-114-03

scharf
sharp
agudo
acuto



16-114-04

scharf
sharp
agudo
acuto



16-116-01

stumpf
blunt
romo
smusso



16-116-02

stumpf
blunt
romo
smusso



16-116-03

stumpf
blunt
romo
smusso



16-116-04

stumpf
blunt
romo
smusso

16-114-01 - 16-114-04 16,0 cm, 6 1/4"

16-116-01 - 16-116-04 16,0 cm, 6 1/4"



16-117-04

scharf
sharp
agudo
acuto



16-118-04

stumpf
blunt
romo
smusso

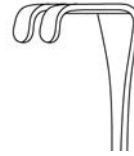

14,0 x 8,0 mm

16-119-01



16-117-04 - 16-118-04 16,0 cm, 6 ¼ "

16-119-01 16,0 cm, 6 ¼ "



12,0 x 6,0 mm

16-119-02



12,0 x 11,0 mm

16-119-03



15,0 x 11,0 mm

16-119-04



16-119-13



KLAPP

16-119-02 - 16-119-04 17,5 cm, 7 "

MOLDESTAD

16-119-13 13,0 cm, 5 ⅛ "



16-120-01

scharf
sharp
agudo
acuto



16-122-01

stumpf
blunt
romo
smusso



16-120-02

scharf
sharp
agudo
acuto



16-122-02

stumpf
blunt
romo
smusso



16-120-03

scharf
sharp
agudo
acuto



16-122-03

stumpf
blunt
romo
smusso



16-120-04

scharf
sharp
agudo
acuto



16-122-04

stumpf
blunt
romo
smusso



16-120-01 - 16-122-04 16,0 cm, 6 1/4"



7,0 mm

16-121-07



9,0 mm

16-121-09



7,0 mm

16-123-14

stumpf
blunt
romo
smusso



BERGMANN

16-121-07 - 16-121-09 16,0 cm, 6 1/4"

16-123-14 14,0 cm, 5 1/2"



16-124-01

scharf
sharp
agudo
acuto



16-125-01

halbscharf
semi-sharp
semi-agudo
semi-acuto



16-126-01

stumpf
blunt
romo
smusso

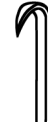

16-124-11

scharf
sharp
agudo
acuto



16-125-11

stumpf
blunt
romo
smusso



16-124-02

scharf
sharp
agudo
acuto



16-125-02

halbscharf
semi-sharp
semi-agudo
semi-acuto



16-126-02

stumpf
blunt
romo
smusso



16-124-12

scharf
sharp
agudo
acuto



16-125-12

stumpf
blunt
romo
smusso



16-124-03

scharf
sharp
agudo
acuto



16-125-03

halbscharf
semi-sharp
semi-agudo
semi-acuto



16-126-03

stumpf
blunt
romo
smusso



16-124-13

scharf
sharp
agudo
acuto



16-125-13

stumpf
blunt
romo
smusso



16-124-04

scharf
sharp
agudo
acuto



16-125-04

halbscharf
semi-sharp
semi-agudo
semi-acuto



16-126-04

stumpf
blunt
romo
smusso



16-124-14

scharf
sharp
agudo
acuto



16-125-14

stumpf
blunt
romo
smusso



16-124-01 - 16-126-04 16,5 cm, 6 1/2 "

16-124-11 - 16-125-14 16,5 cm, 6 1/2 "

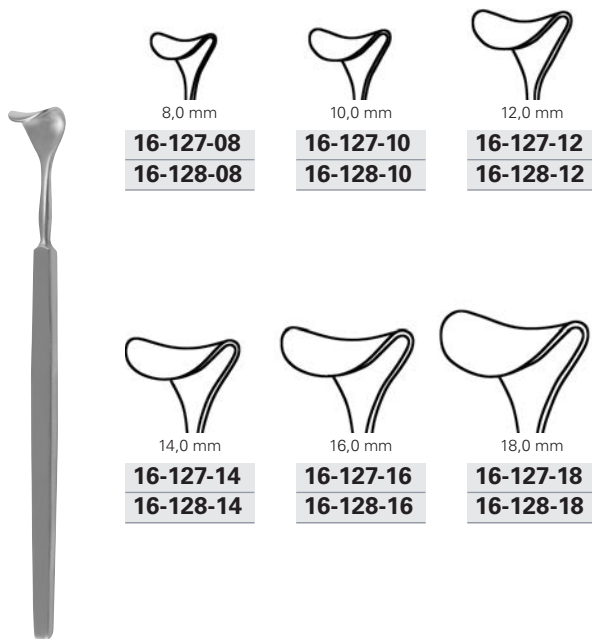

8,0 mm
16-127-08
16-128-08

10,0 mm
16-127-10
16-128-10

12,0 mm
16-127-12
16-128-12

14,0 mm
16-127-14
16-128-14

16,0 mm
16-127-16
16-128-16

18,0 mm
16-127-18
16-128-18

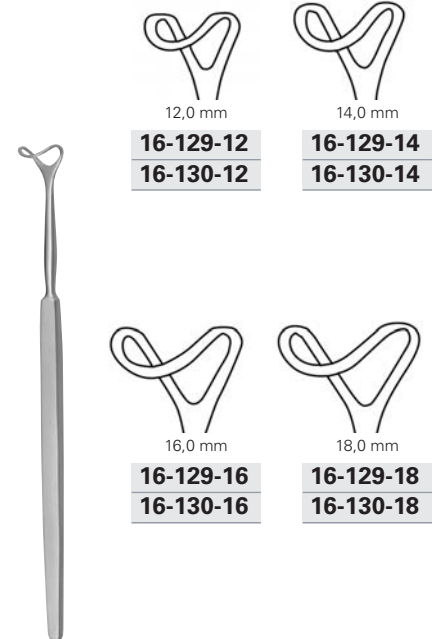

12,0 mm
16-129-12
16-130-12

14,0 mm
16-129-14
16-130-14

16,0 mm
16-129-16
16-130-16

18,0 mm
16-129-18
16-130-18

DESMARRES

16-127-08 - 16-127-18 13,0 cm, 5 1/8"
16-128-08 - 16-128-18 16,0 cm, 6 1/4"

DESMARRES

16-129-12 - 16-129-18 13,0 cm, 5 1/8"
16-130-12 - 16-130-18 16,0 cm, 6 1/4"

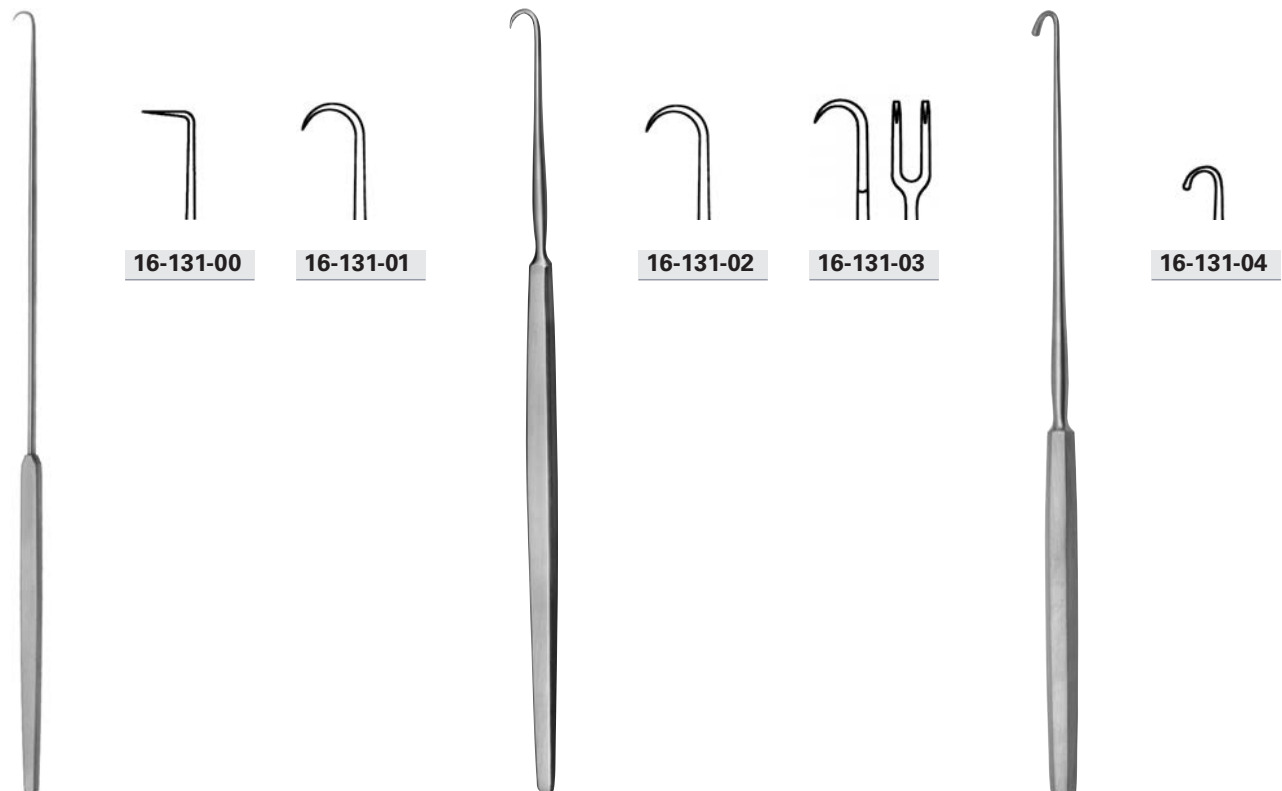

16-131-00

16-131-01

16-131-02

16-131-03

16-131-04

EMMET

16-131-00 - 16-131-01 22,0 cm, 8 3/4"

SIMON

16-131-02 - 16-131-03 22,0 cm, 8 3/4"

LANGE

16-131-04 23,0 cm, 9"

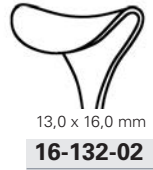

KOENIG

16-132-01 - 16-132-02 18,0 cm, 7 "

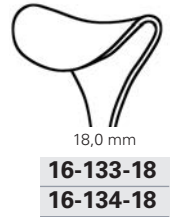
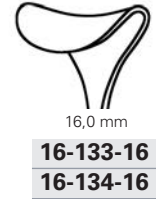

CUSHING

16-133-08 - 13-133-08 20,0 cm, 8 "
16-134-08 - 13-134-08 24,0 cm, 9 ½ "



CUSHING-KOCHER

16-135-10 20,0 cm, 8 "



20,0 x 15,0 mm
16-135-20
20,0 x 19,0 mm

16-135-20 20,5 cm, 8 "

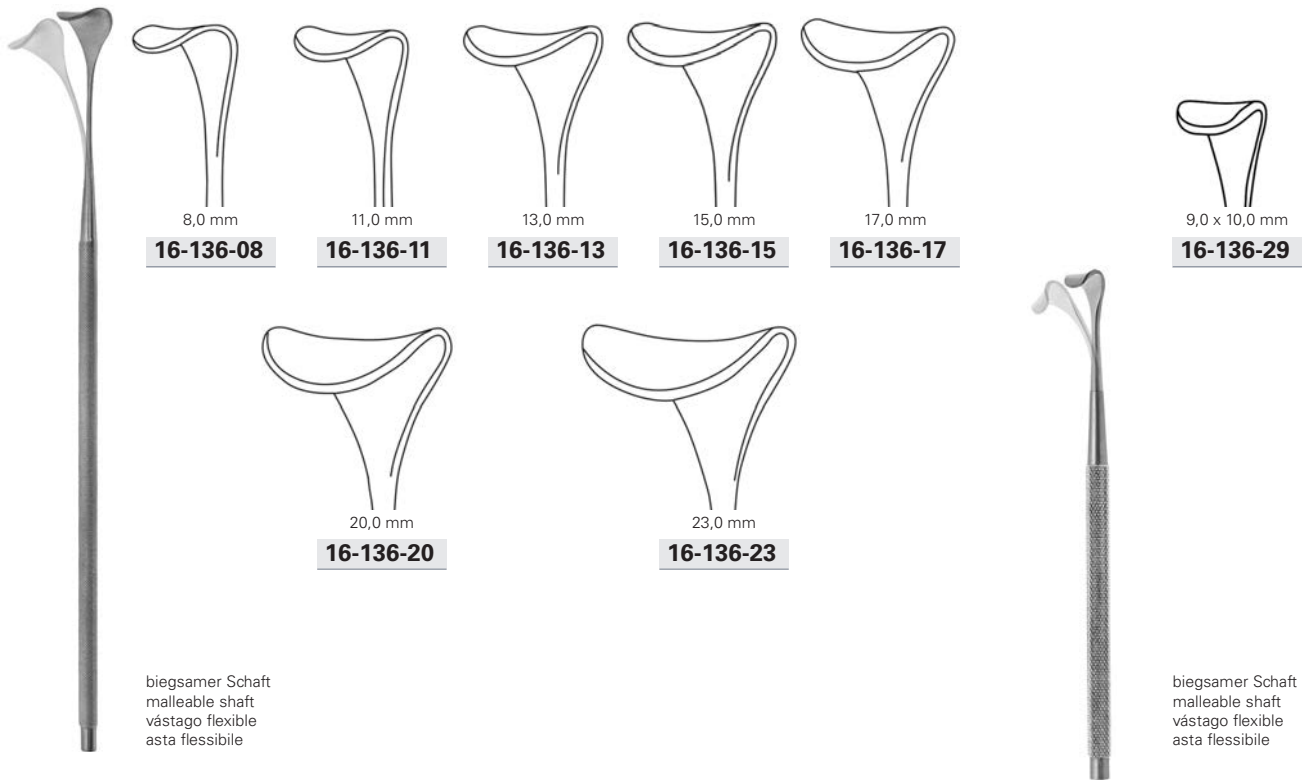

biegsamer Schaft
malleable shaft
vástagó flexible
asta flessibile

biegsamer Schaft
malleable shaft
vástagó flexible
asta flessibile

GILL-VERNET

16-136-08 - 13-136-23 24,0 cm, 9 1/2"

KIRKLIN

16-136-29 13,5 cm, 5 1/4"

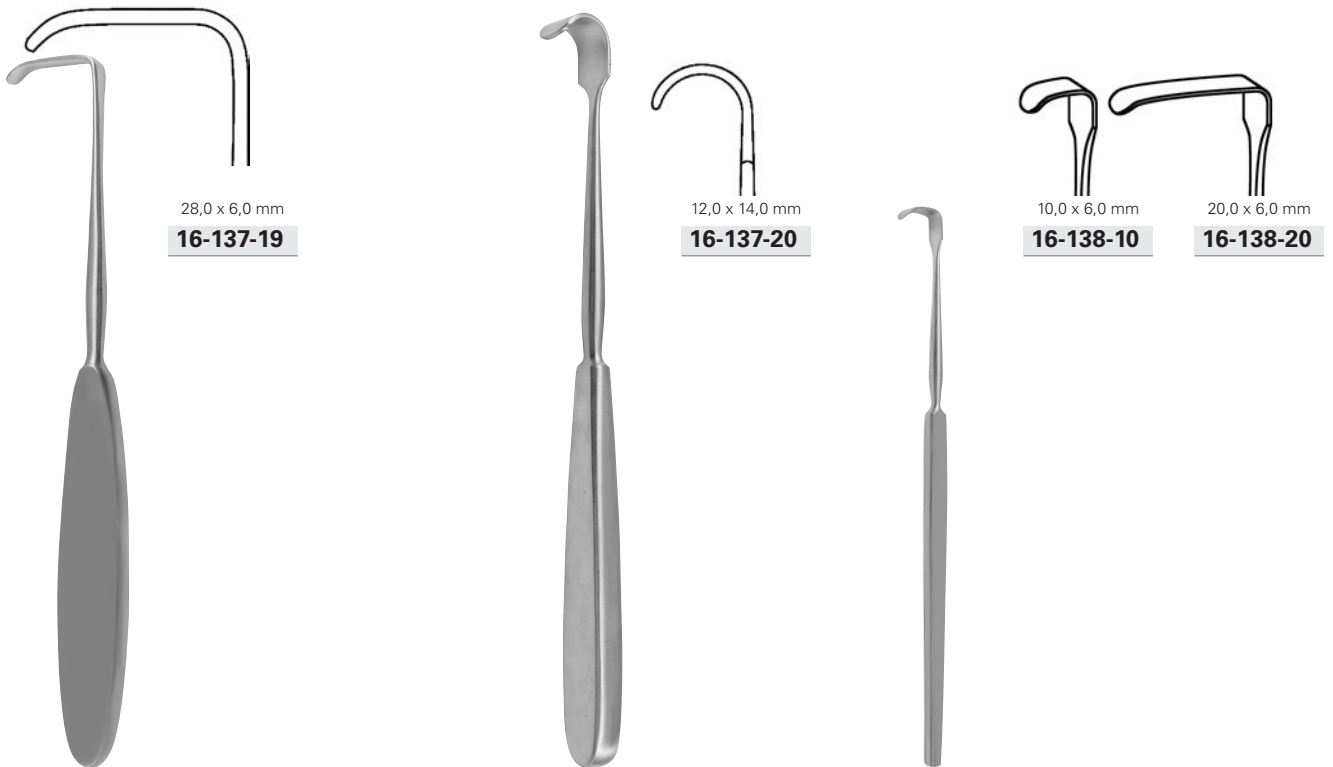

LAHEY

16-137-19 19,0 cm, 7 1/2"

LITTLE

16-137-20 20,0 cm, 8"

SENN-GREEN

16-138-10 - 16-138-20 15,0 cm, 6"

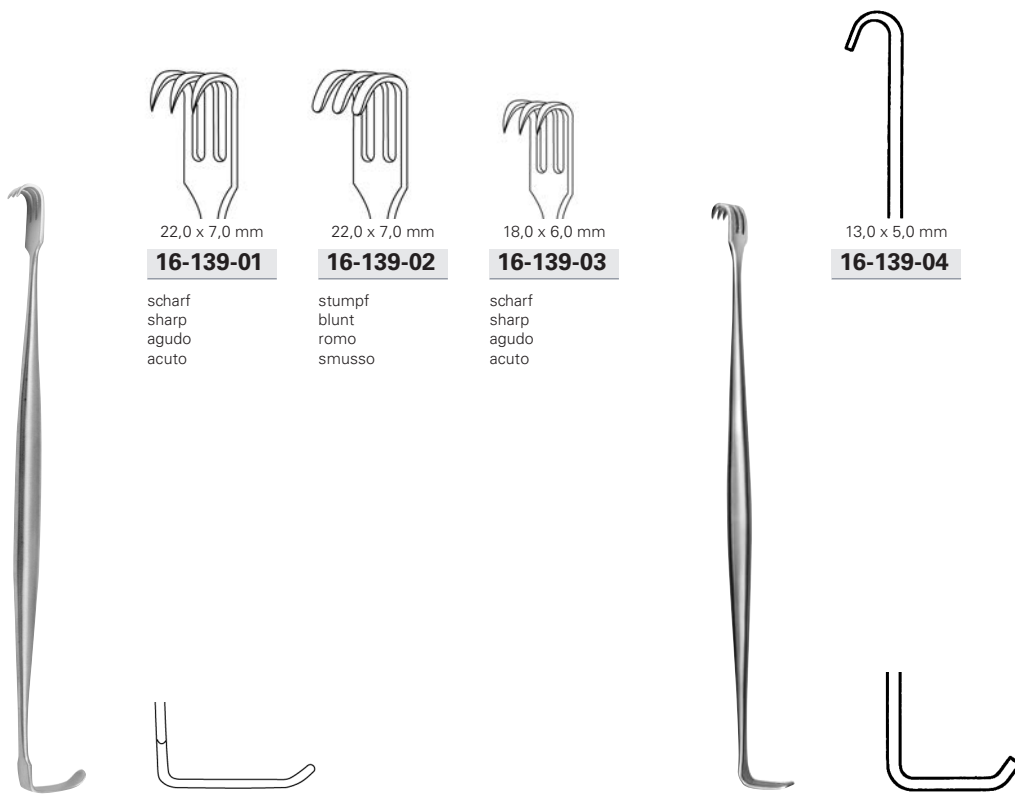

22,0 x 7,0 mm
16-139-01

scharf
sharp
agudo
acuto

22,0 x 7,0 mm
16-139-02

stumpf
blunt
romo
smusso

18,0 x 6,0 mm
16-139-03

scharf
sharp
agudo
acuto

13,0 x 5,0 mm
16-139-04

SENN-MILLER

16-139-01 - 16-139-03 16,0 cm, 6 ¼ "

KILNER

16-139-04 15,5 cm, 6 "

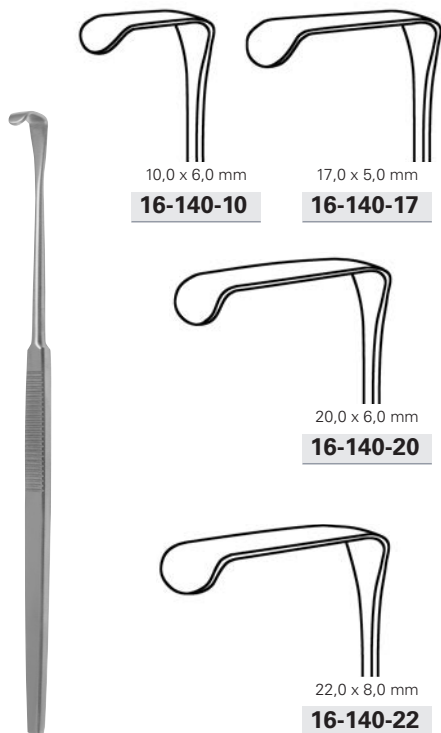

10,0 x 6,0 mm
16-140-10

17,0 x 5,0 mm
16-140-17

20,0 x 6,0 mm
16-140-20

22,0 x 8,0 mm
16-140-22

MINI-LANGENBECK

16-140-10 - 16-140-22 16,0 cm, 6 ¼ "

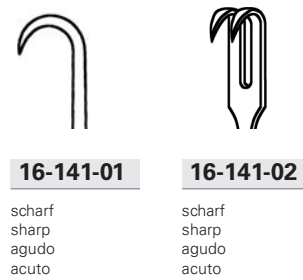

16-141-01

scharf
sharp
agudo
acuto

16-141-02

scharf
sharp
agudo
acuto

16-141-01 - 16-141-02 16,0 cm, 6 ¼ "

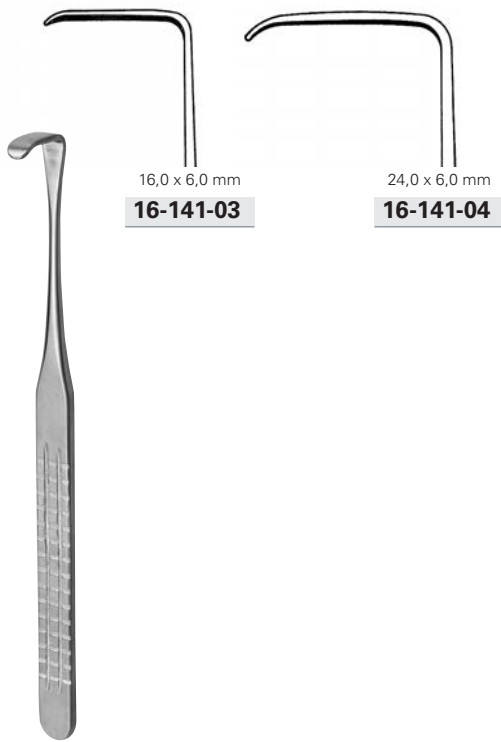

16-141-03 - 16-141-04 16,0 cm, 6 ¼"

16-141-05 16,0 cm, 6 ¼"



RAGNELL-DAVIS

16-142-14 14,0 cm, 5 ½"

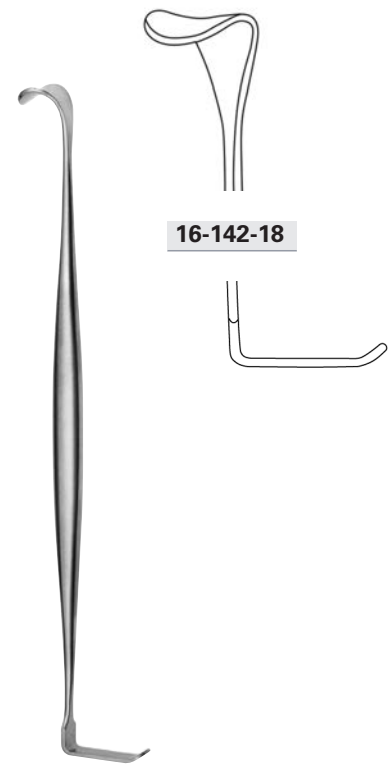

COPE

16-142-18 18,0 cm, 7"

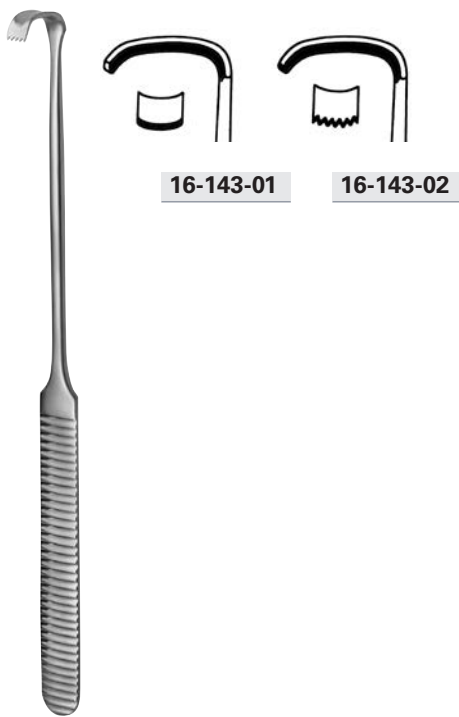

STRANDELL-STILLE

16-143-01 - 16-143-02 19,0 cm, 7 ½ "

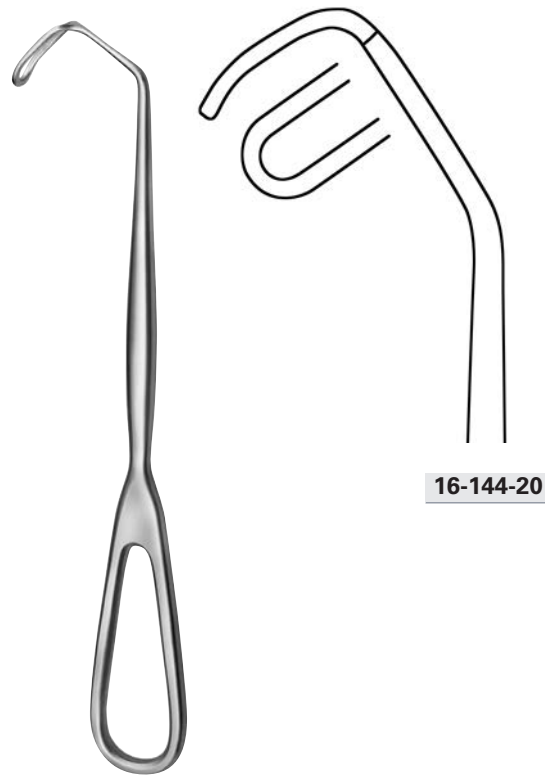

CUSHING

16-144-20 20,0 cm, 8 "



CUSHING

16-144-21 21,0 cm, 8 ¼ "

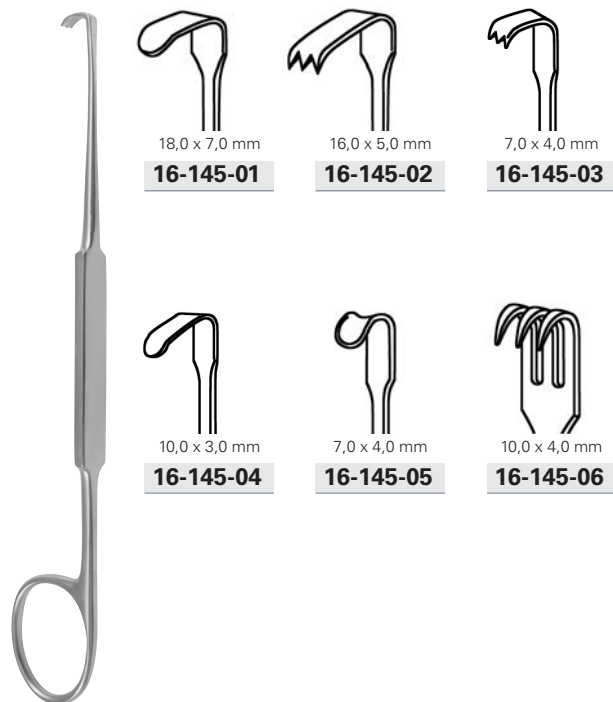

MEYERDING

16-145-01 - 16-145-06 18,0 cm, 7 "



16-146-01

scharf
sharp
agudo
acuto



16-146-02

scharf
sharp
agudo
acuto



16-146-03

scharf
sharp
agudo
acuto



16-146-04

scharf
sharp
agudo
acuto



16-146-06

scharf
sharp
agudo
acuto

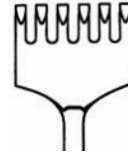

16-148-01

stumpf
blunt
romo
smusso



16-148-02

stumpf
blunt
romo
smusso



16-148-03

stumpf
blunt
romo
smusso



16-148-04

stumpf
blunt
romo
smusso



16-148-06

stumpf
blunt
romo
smusso

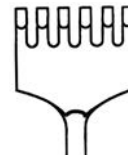

16-146-01 - 16-148-06 17,0 cm, 6 3/4"



16-149-15



BARSKY

16-149-15 15,0 cm, 6"



16-150-16



KILNER

16-150-16 16,0 cm, 6 1/4"



16-152-01



GILLIES

16-152-01 - 16-152-02 18,0 cm, 7"

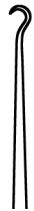

16-152-02

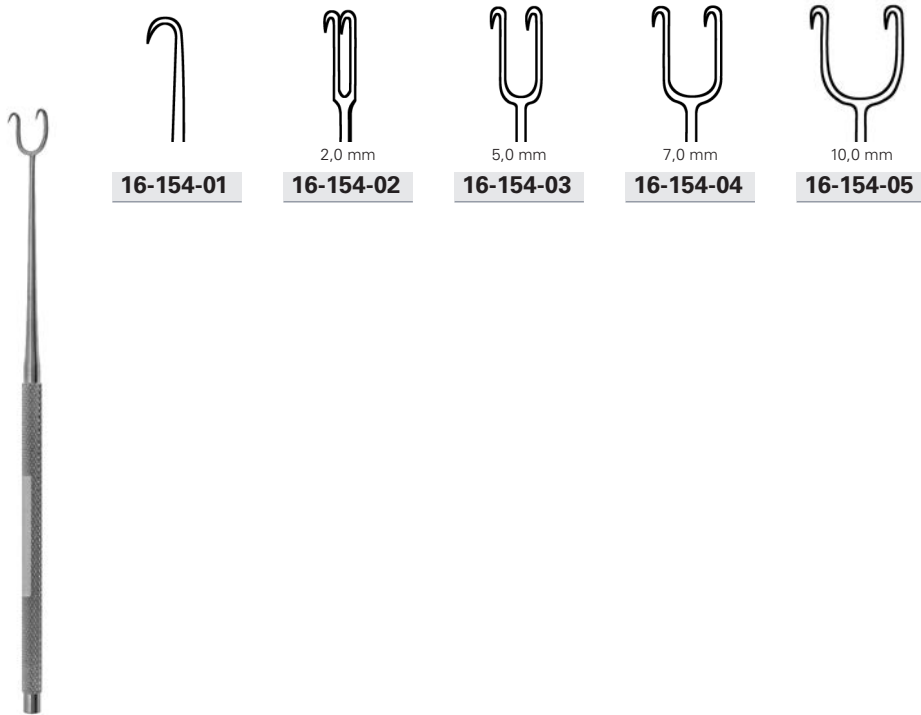

JOSEPH

16-154-01 - 16-154-05 16,0 cm, 6 ¼ "

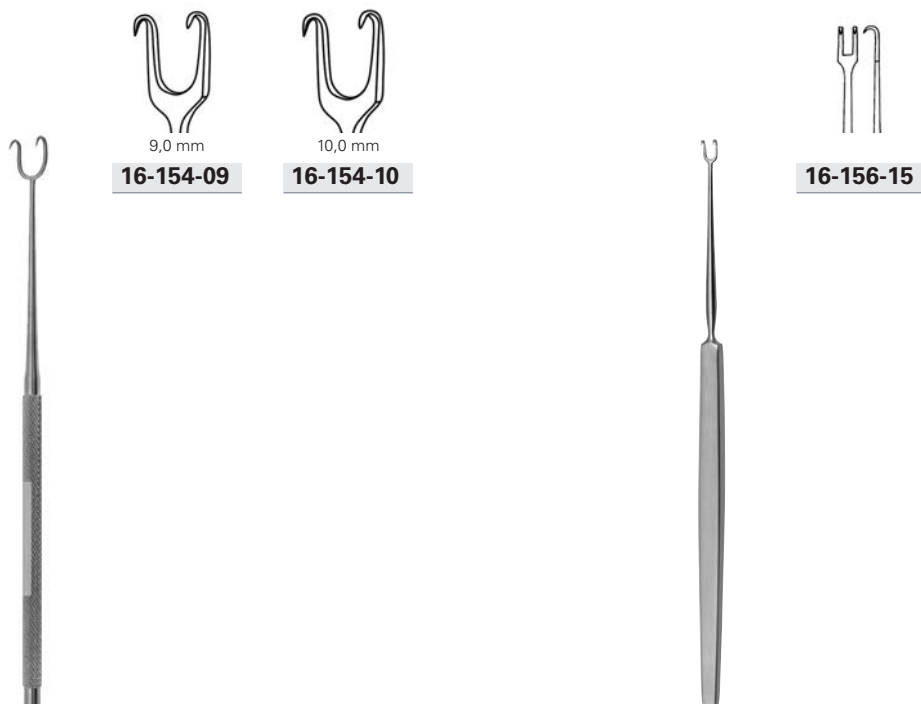

MC INDOE

16-154-09 - 16-154-10 15,0 cm, 6 "

FREER

16-156-15 15,0 cm, 6 "



Fig. 1 | 3,0 mm
16-158-01



Fig. 2 | 5,0 mm
16-158-02

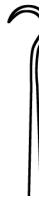

Fig. 3 | 7,0 mm
16-158-03



14,0 mm
16-160-14



18,0 mm
16-160-18



22,0 mm
16-160-22



KLEINERT-KUTZ

16-158-01 - 16-158-03 13,0 cm, 5 1/8"



CUSHING

16-160-14 - 16-160-22 25,0 cm, 9 3/4"



11,0 x 8,0 mm
16-162-12



PAUL

16-162-12 12,0 cm, 4 3/4"



KAYE-MILLARD

16-164-08 8,0 cm, 3"



MUELLER

16-201-05 6,5 cm, 2 1/3"



BOSE

16-202-06 6,0 cm, 2 1/4"



FINSEN

16-203-05 - 16-204-05 5,0 cm, 2"

16-203-07 - 16-204-07 7,0 cm, 2 3/4"



2 x 3

16-203-05

3 x 4

16-203-07

scharf
sharp
agudo
acuto



2 x 3

16-204-05

3 x 4

16-204-07

stumpf
blunt
romo
smusso

3 x 4



16-206-07

scharf
sharp
agudo
acuto

3 x 4



16-207-07

stumpf
blunt
romo
smusso

4 x 4



16-209-10

scharf
sharp
agudo
acuto

4 x 4



16-210-10

stumpf
blunt
romo
smusso



FINSEN

16-206-07 - 16-207-07 7,0 cm, 2 3/4"



HOLZHEIMER

16-209-10 - 16-210-10 10,0 cm, 4"

4 x 4

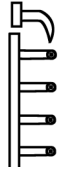

16-212-07
16-212-10

scharf
sharp
agudo
acuto

4 x 4

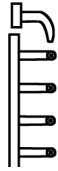

16-213-07
16-213-10

stumpf
blunt
romo
smusso



ALM

16-212-07 - 16-213-07 7,0 cm, 2 3/4"

16-212-10 - 16-213-10 10,0 cm, 4"

3 x 3



16-214-06

scharf
sharp
agudo
acuto

3 x 3

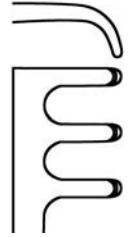

16-215-06

stumpf
blunt
romo
smusso



JANSEN

16-214-06 - 16-215-06 10,0 cm, 4"

3 x 4

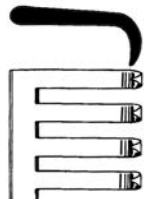

16-216-14

scharf
sharp
agudo
acuto

3 x 4

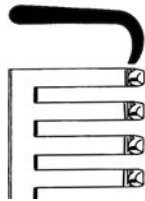

16-216-15

stumpf
blunt
romo
smusso



SCALP-CONTOUR

16-216-14 - 16-216-15 14,0 cm, 5 1/2"

2 x 3



16-217-10

scharf
sharp
agudo
acuto

2 x 3

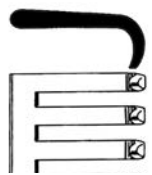

16-218-10

stumpf
blunt
romo
smusso



WEITLANER

16-217-10 - 16-218-10 11,0 cm, 4 1/4"

3 x 4

3 x 4

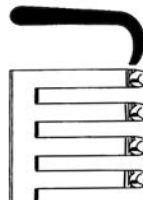
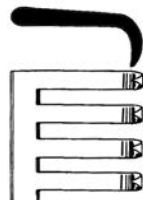

16-217-13
16-217-16

scharf
sharp
agudo
acuto

16-218-13
16-218-16

stumpf
blunt
romo
smusso

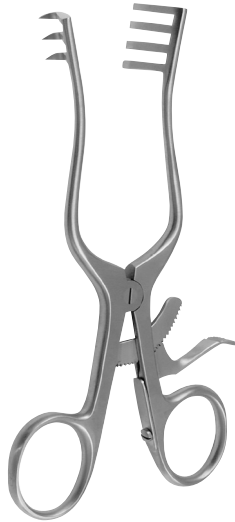

WEITLANER

16-217-13 - 16-218-13 13,5 cm, 5 ¼"
16-217-16 - 16-218-16 16,0 cm, 6 ¼"

3 x 4

3 x 4

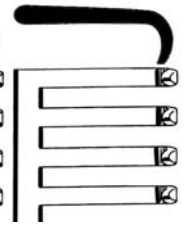
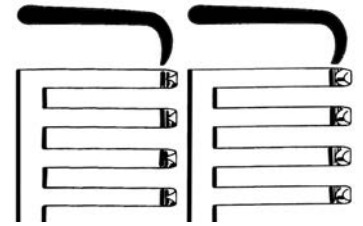

16-217-14

scharf
sharp
agudo
acuto

16-218-14

stumpf
blunt
romo
smusso



WEITLANER

16-217-14 - 16-218-14 13,5 cm, 5 ¼"

3 x 3

3 x 3

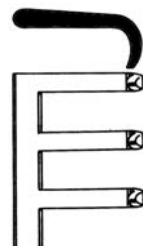
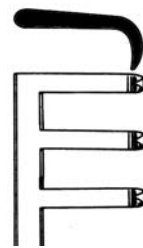

16-219-11
16-219-13

scharf
sharp
agudo
acuto

16-220-11
16-220-13

stumpf
blunt
romo
smusso

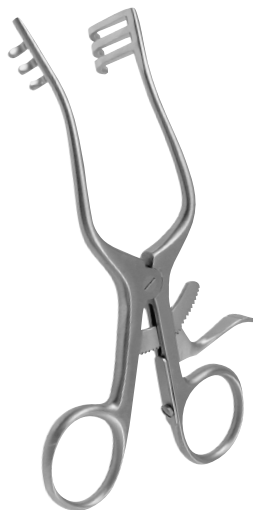

WULLSTEIN

16-219-11 - 16-220-11 11,0 cm, 4 ¼"
16-219-13 - 16-220-13 13,0 cm, 5"

4 x 4



16-221-15

scharf
sharp
agudo
acuto



MOLLISON

16-221-15 15,5 cm, 6"

1 x 2

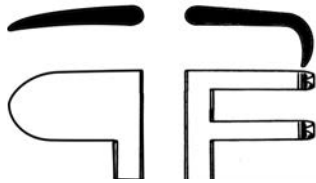

16-224-11
16-224-13

scharf
sharp
agudo
acuto

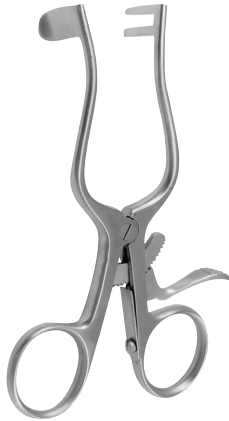

PLESTER

16-224-11	11,0 cm, 4 1/4"
16-224-13	13,0 cm, 5"

1 x 2

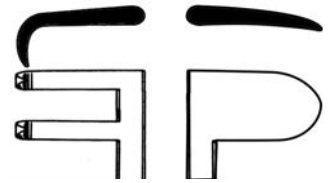

16-225-11
16-225-13

scharf
sharp
agudo
acuto



PLESTER

16-225-11	11,0 cm, 4 1/4"
16-225-13	13,0 cm, 5"

2 x 2

2 x 2

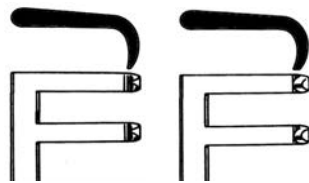

16-222-11
16-222-13

scharf
sharp
agudo
acuto

16-223-11
16-223-13

stumpf
blunt
romo
smusso



PLESTER

16-222-11 - 16-223-11	11,0 cm, 4 1/4"
16-222-13 - 16-223-13	13,0 cm, 5"

1 x 3

1 x 3

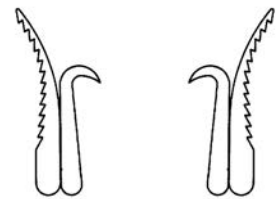

16-226-13

scharf
sharp
agudo
acuto

16-226-14

scharf
sharp
agudo
acuto



PERKINS

16-226-13 - 16-226-14	13,0 cm, 5"
------------------------------	-------------

3 x 3

3 x 3

4 x 4

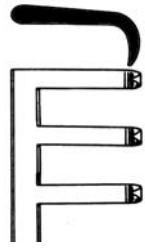

16-227-13

scharf
sharp
agudo
acuto

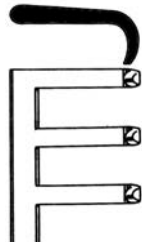

16-228-13

stumpf
blunt
rombo
smusso



MILIGAN

16-227-13 - 16-228-13 13,0 cm, 5"

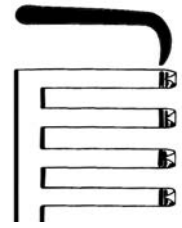

16-229-17

scharf
sharp
agudo
acuto

HENDERSON

16-229-17 17,0 cm, 6 3/4"

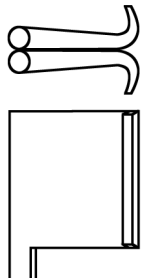

16-230-13



WEITLANER-BABY

16-230-13 13,5 cm, 5 1/4"

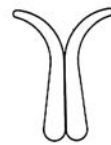

16-231-16

MOD. TUEBINGEN

16-231-16 16,5 cm, 6 1/2"

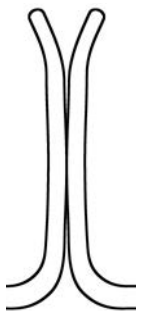
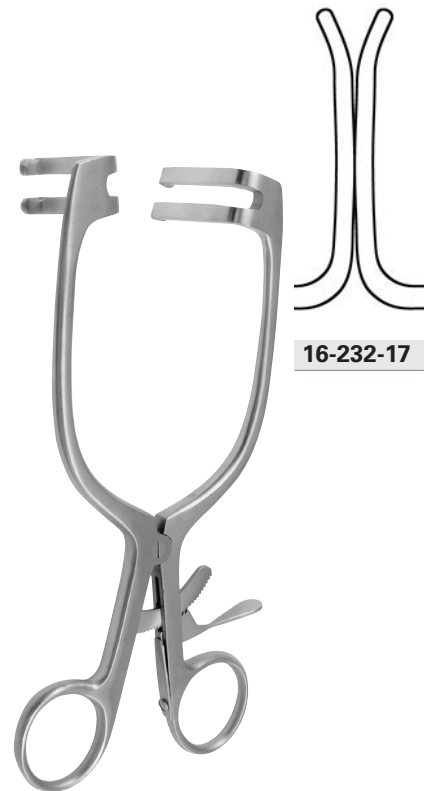

16-232-17

MAYO-ADAMS

16-232-17 16,5 cm, 6 1/2"

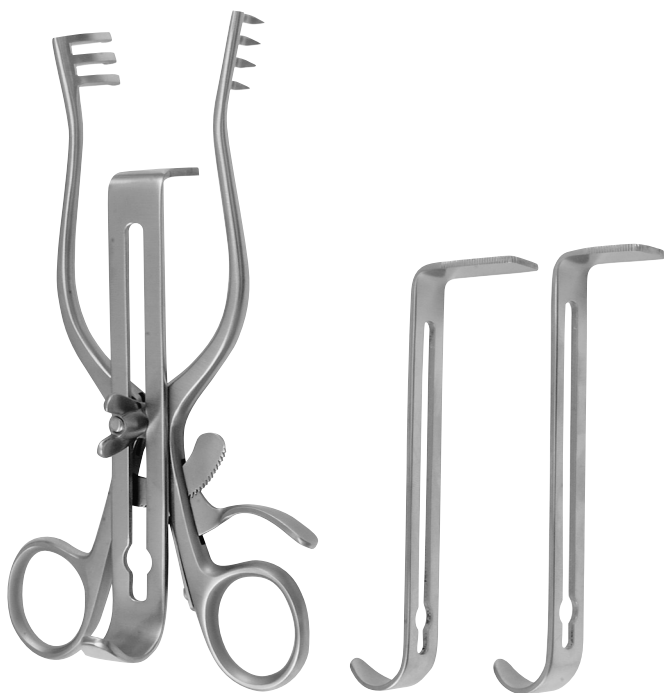

HENLEY

16-234-00 SET

Wundspreizer komplett,
bestehend aus:

- 1 Wundspreizer, scharf **16-234-01**
- 1 Mittelvalve, 19 x 16 mm **16-236-19**
- 1 Mittelvalve, 25 x 16 mm **16-236-25**
- 1 Mittelvalve, 32 x 16 mm **16-236-32**

Self-retaining retractor complete,
consisting of:

- 1 Retractor, sharp **16-234-01**
- 1 Central valve 19 x 16 mm **16-236-19**
- 1 Central valve 25 x 16 mm **16-236-25**
- 1 Central valve 32 x 16 mm **16-236-32**

Seperador autoestáticos completo,
compuesto de:

- 1 Seperador, agudas **16-234-01**
- 1 Valva central 19 x 16 mm **16-236-19**
- 1 Valva central 25 x 16 mm **16-236-25**
- 1 Valva central 32 x 16 mm **16-236-32**

Divaricatore autostatici completo,
composto da:

- 1 Divaricatore, acuto **16-234-01**
- 1 Valva centrale 19 x 16 mm **16-236-19**
- 1 Valva centrale 25 x 16 mm **16-236-25**
- 1 Valva centrale 32 x 16 mm **16-236-32**

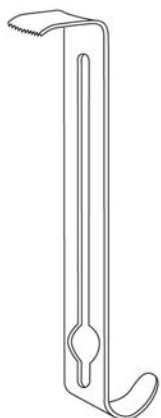

16-236-19

19 x 16 mm

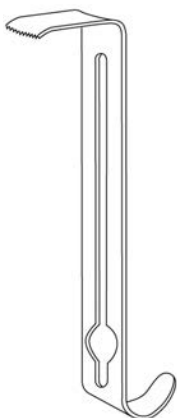

16-236-25

25 x 16 mm

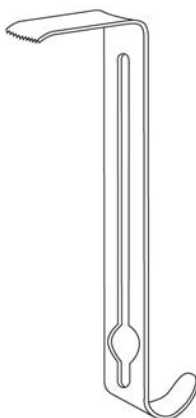

16-236-32

32 x 16 mm

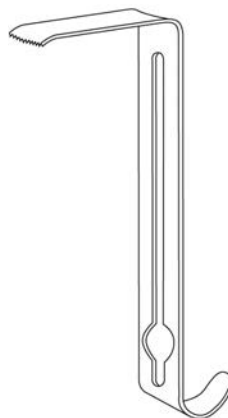

16-236-40

40 x 16 mm

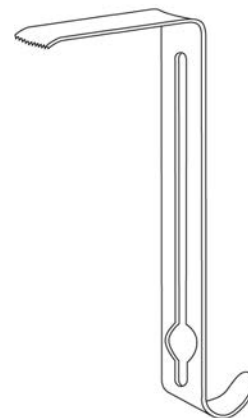

16-236-45

45 x 16 mm

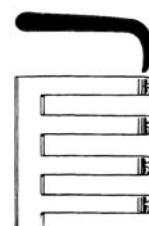

scharf, 15 mm
sharp, 15 mm
agudo, 15 mm
acuto, 15 mm

HENLEY

16-234-01 16,0 cm, 6 ¼ "

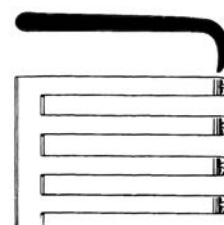

scharf, 25 mm
sharp, 25 mm
agudo, 25 mm
acuto, 25 mm

HENLEY

16-234-02 16,0 cm, 6 ¼ "

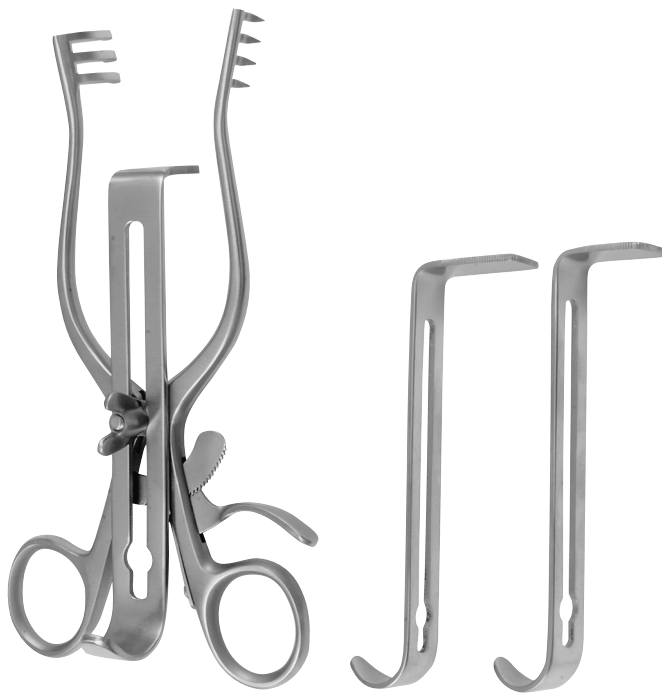

HENLEY

16-235-00 SET

Wundspreizer komplett,
bestehend aus:

1 Wundspreizer, stumpf	16-235-01
1 Mittelvalve, 19 x 16 mm	16-236-19
1 Mittelvalve, 25 x 16 mm	16-236-25
1 Mittelvalve, 32 x 16 mm	16-236-32

Self-retaining retractor complete,
consisting of:

1 Retractor, blunt	16-235-01
1 Central valve 19 x 16 mm	16-236-19
1 Central valve 25 x 16 mm	16-236-25
1 Central valve 32 x 16 mm	16-236-32

Seperador autoestáticos completo,
compuesto de:

1 Seperador, romas	16-235-01
1 Valva central 19 x 16 mm	16-236-19
1 Valva central 25 x 16 mm	16-236-25
1 Valva central 32 x 16 mm	16-236-32

Divaricatore autostatici completo,
composto da:

1 Divaricatore, smusso	16-235-01
1 Valva centrale 19 x 16 mm	16-236-19
1 Valva centrale 25 x 16 mm	16-236-25
1 Valva centrale 32 x 16 mm	16-236-32

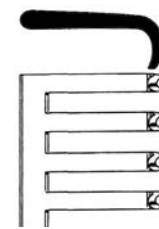

stumpf, 15 mm
blunt, 15 mm
romo, 15 mm
smusso, 15 mm

HENLEY

16-235-01 16,0 cm, 6 ¼ "

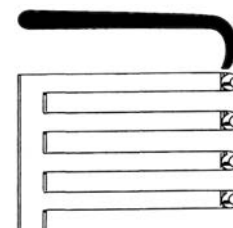

stumpf, 25 mm
blunt, 25 mm
romo, 25 mm
smusso, 25 mm

HENLEY

16-235-02 16,0 cm, 6 ¼ "

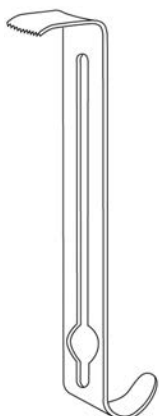

16-236-19

19 x 16 mm

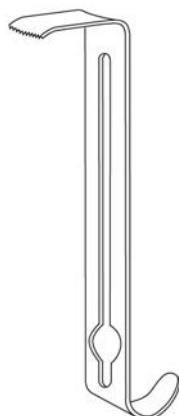

16-236-25

25 x 16 mm

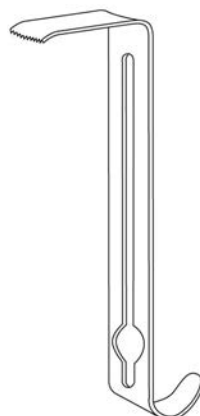

16-236-32

32 x 16 mm

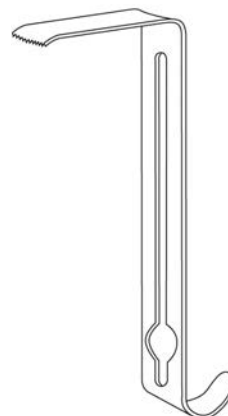

16-236-40

40 x 16 mm

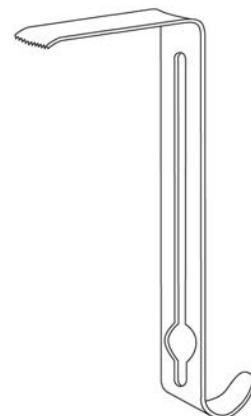

16-236-45

45 x 16 mm

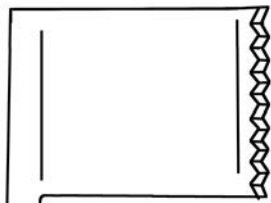

32 x 25 mm
16-237-01

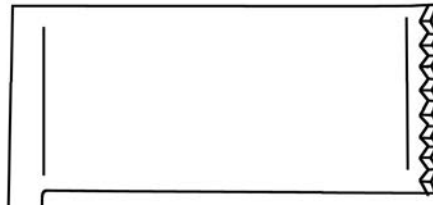

54 x 25 mm
16-237-02



60 x 19 mm
16-237-03



60 x 25 mm
16-237-04

MEYERDING

16-237-01 - 16-237-04 20,0 cm, 8"

80 x 40 mm

68 x 25 mm



DARLING

16-239-01 18,0 cm, 7"

68 x 25 mm

80 x 40 mm



DARLING

16-239-02 18,0 cm, 7"

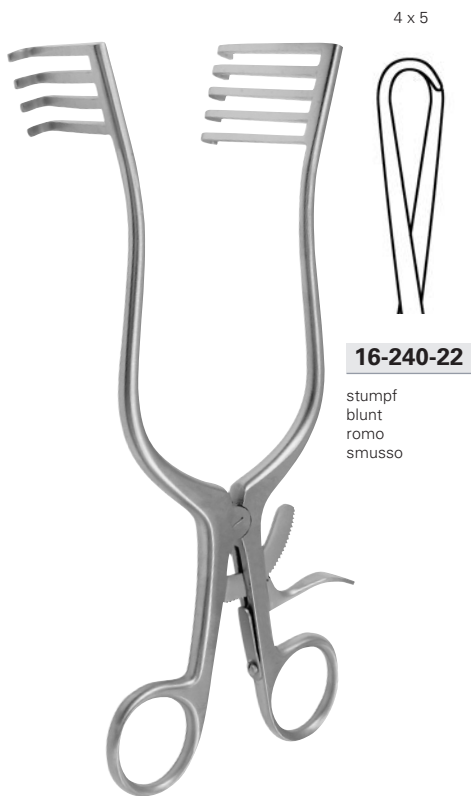

NORFOLK & NORWICH

16-240-22 22,0 cm, 8 3/4"

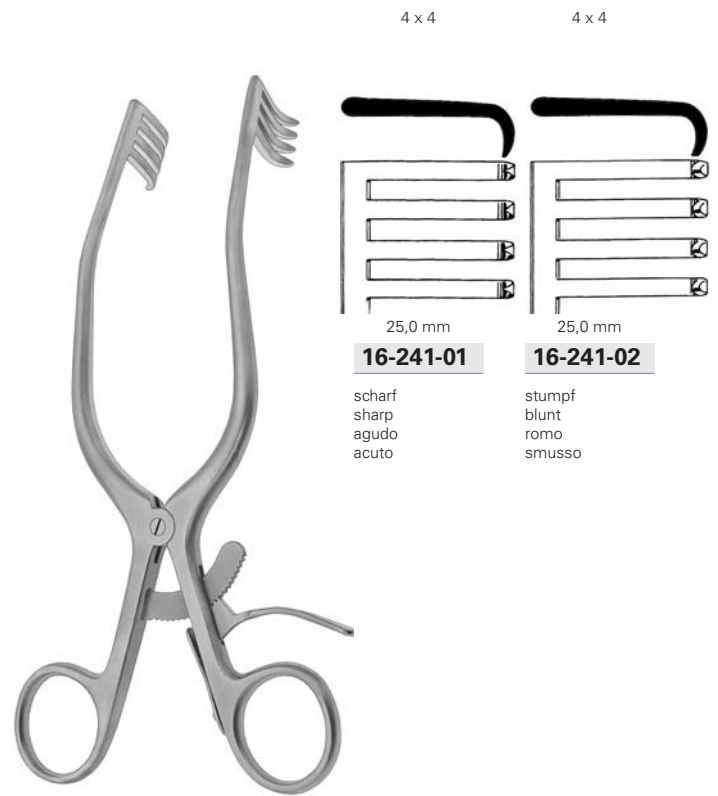

ADSON

16-241-01 - 16-241-02 20,0 cm, 8"

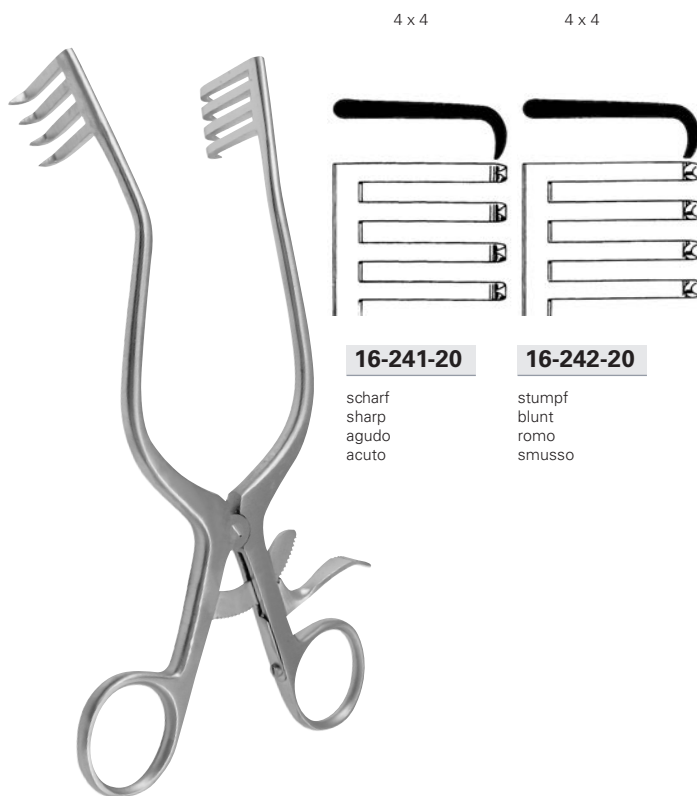

ANDERSON-ADSON

16-241-20 - 16-242-20 20,0 cm, 8"

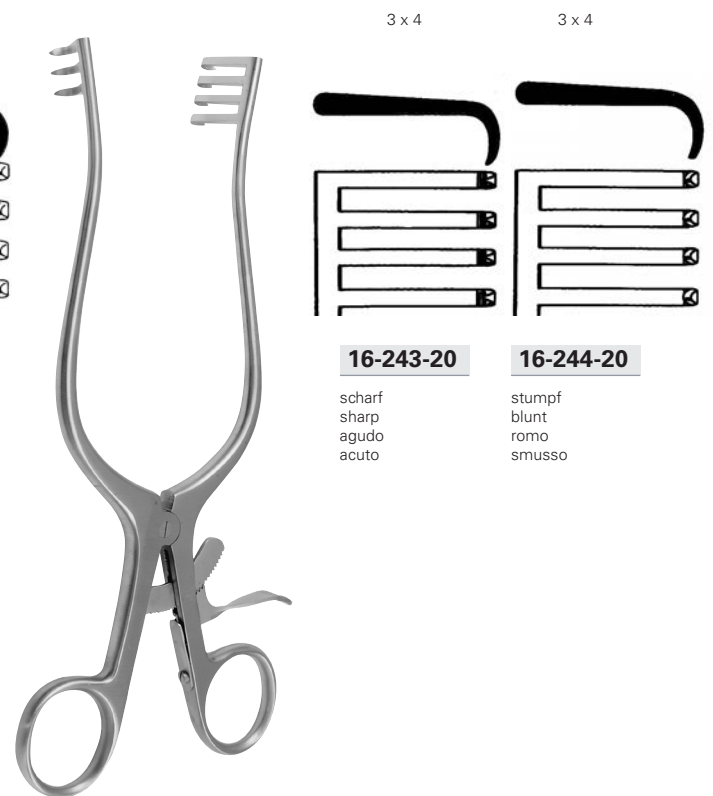

WEITLANER

16-243-20 - 16-244-20 20,0 cm, 8"

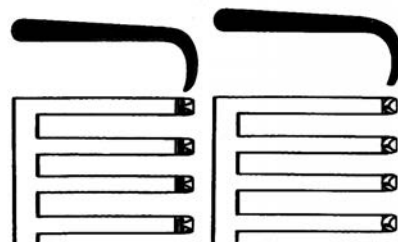

3 x 4

16-243-24

5 x 6

16-243-26

scharf
sharp
agudo
acuto

3 x 4

16-244-24

5 x 6

16-244-26

stumpf
blunt
romo
smusso



7 x 7

16-245-20

scharf
sharp
agudo
acuto

7 x 7

16-245-19

stumpf
blunt
romo
smusso

WEITLANER

16-243-24 - 16-244-24 24,0 cm, 9 1/2"

16-243-26 - 16-244-26 26,0 cm, 10 1/4"

MISKIMON

16-245-19 - 16-245-20 22,0 cm, 8 3/4"

3 x 4

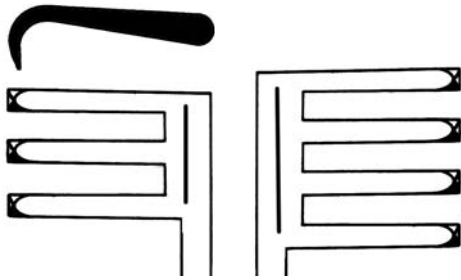

16-246-07

scharf
 sharp
 agudo
 acuto

3 x 4

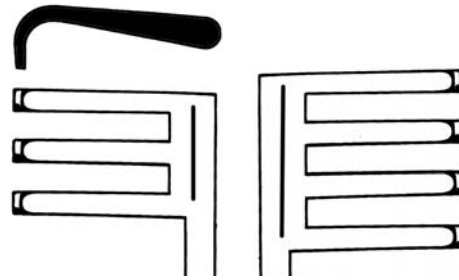

16-247-07

stumpf
 blunt
 romo
 smusso

5 x 6

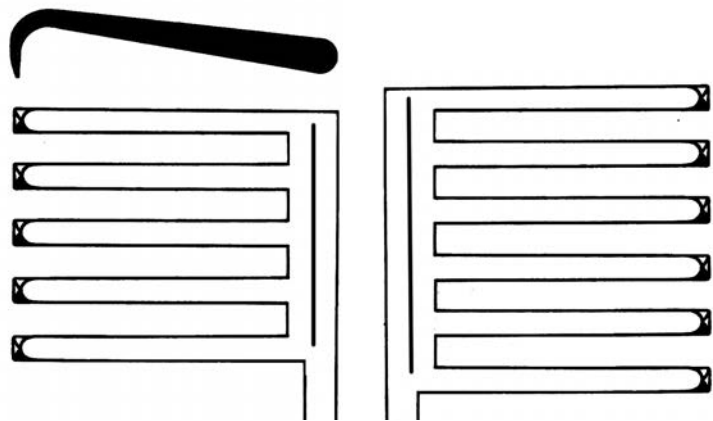

16-246-12

scharf
 sharp
 agudo
 acuto

5 x 6

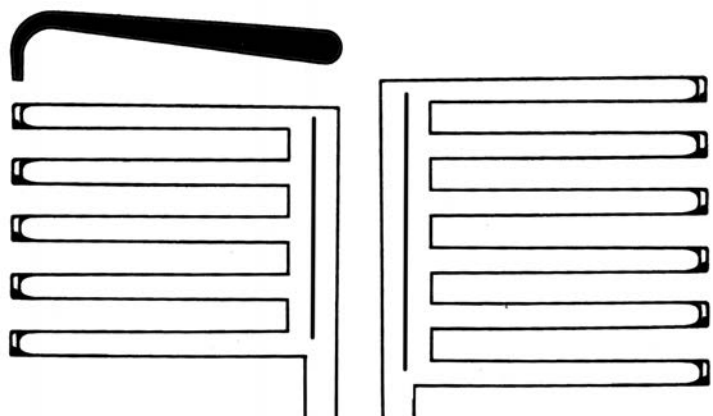

16-247-12

stumpf
 blunt
 romo
 smusso



ADSON

16-246-07 - 16-247-07 26,0 cm, 10 1/4"

16-246-12 - 16-247-12 29,0 cm, 11 1/2"



4 x 5

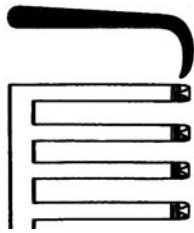

16-245-21

stumpf
blunt
romo
smusso

TRAVERS

16-245-21 21,0 cm, 8 ¼"



4 x 4

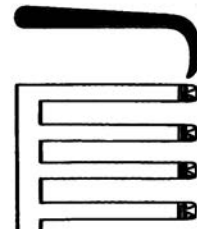

16-246-01

scharf
sharp
agudo
acuto

IRWIN

16-246-01 17,5 cm, 7"



1 x 1



16-248-09
16-248-11

GELPI-LOKTITE

16-248-09 9,0 cm, 3 ½"
16-248-11 11,0 cm, 4 ¾"



1 x 1



16-248-13

GELPI-LOKTITE

16-248-13 13,5 cm, 5 ¼"

1 x 1



16-248-16
16-248-18

GELPI-LOKTITE

16-248-16 16,0 cm, 6 ¼"
16-248-18 18,0 cm, 7"

1 x 1

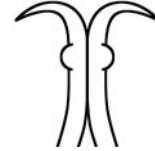

16-249-18

GELPI-LOKTITE

16-249-18 18,0 cm, 7"

1 x 1

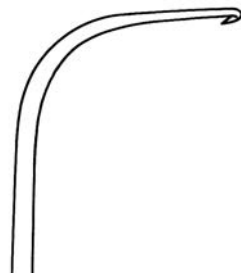
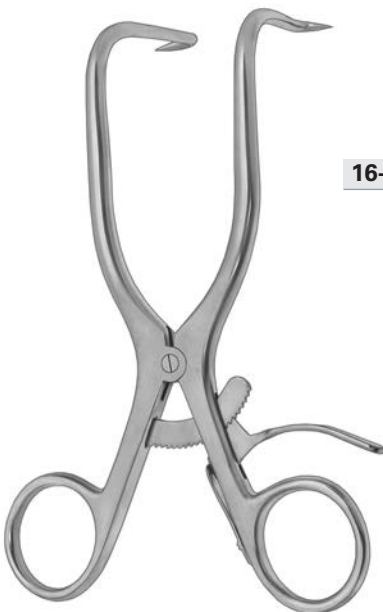

16-250-15

GELPI-SEILETZ

16-250-15 15,0 cm, 6"

1 x 1



16-250-18

JACKSON-BURROWS

16-250-18 18,5 cm, 7 ¼"



RIGBY

16-251-18 18,0 cm, 7"



ADSON

16-252-13 - 16-253-13 13,5 cm, 5 1/4"
16-252-16 - 16-253-16 16,5 cm, 6 1/2"

3 x 4

3 x 4



16-252-13
16-252-16

scharf
sharp
agudo
acuto

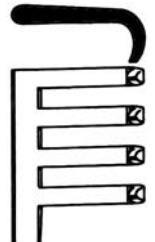

16-253-13
16-253-16

stumpf
blunt
romo
smusso

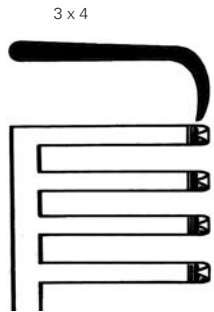

16-252-26

scharf
sharp
agudo
acuto

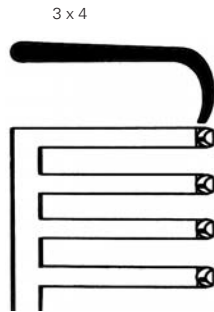

16-253-26

stumpf
blunt
romo
smusso

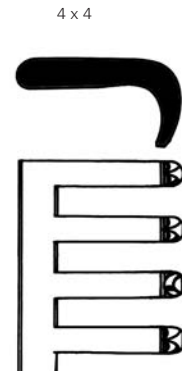

16-256-31

stumpf
blunt
romo
smusso

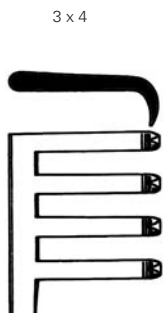

16-252-20

scharf
sharp
agudo
acuto

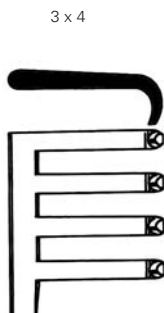

16-253-20

stumpf
blunt
romo
smusso

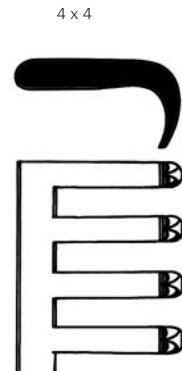

16-255-31

scharf
sharp
agudo
acuto

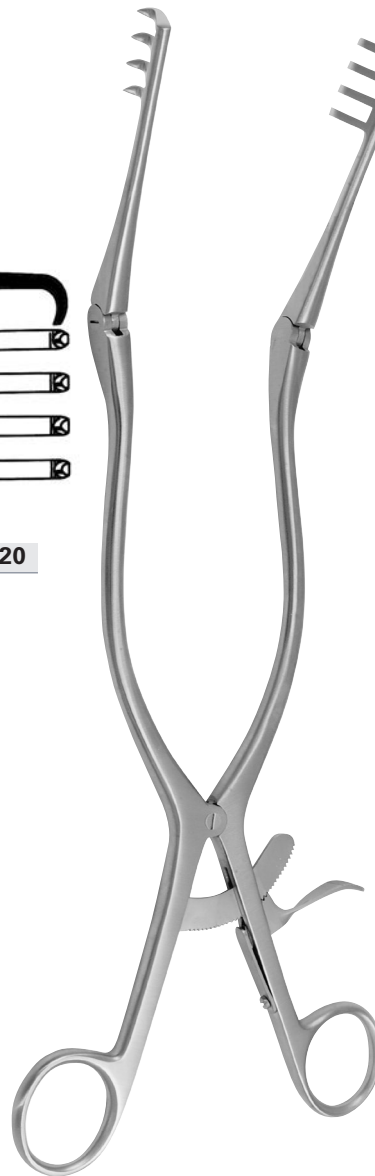

ADSON

16-252-20 - 16-253-20 21,0 cm, 8 1/4"
16-252-26 - 16-253-26 24,5 cm, 9 3/4"

BECKMANN

16-255-31 - 16-256-31 31,0 cm, 12 1/4"



ADSON

16-254-01 - 16-254-02 28,5 cm, 11 ¼"

6 x 6

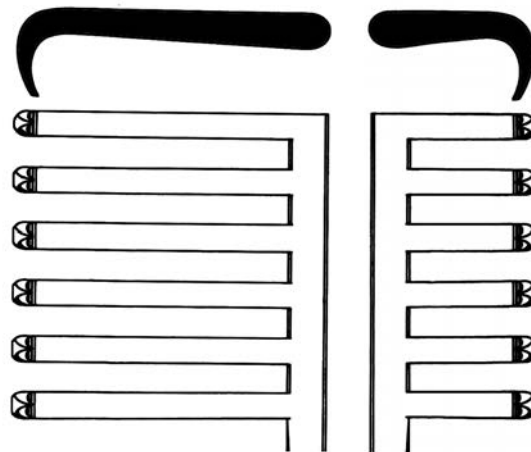

16-254-01

scharf
sharp
agudo
acuto

6 x 6

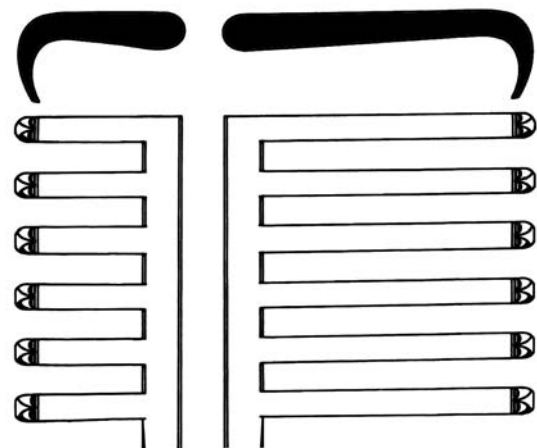

16-254-02

scharf
sharp
agudo
acuto

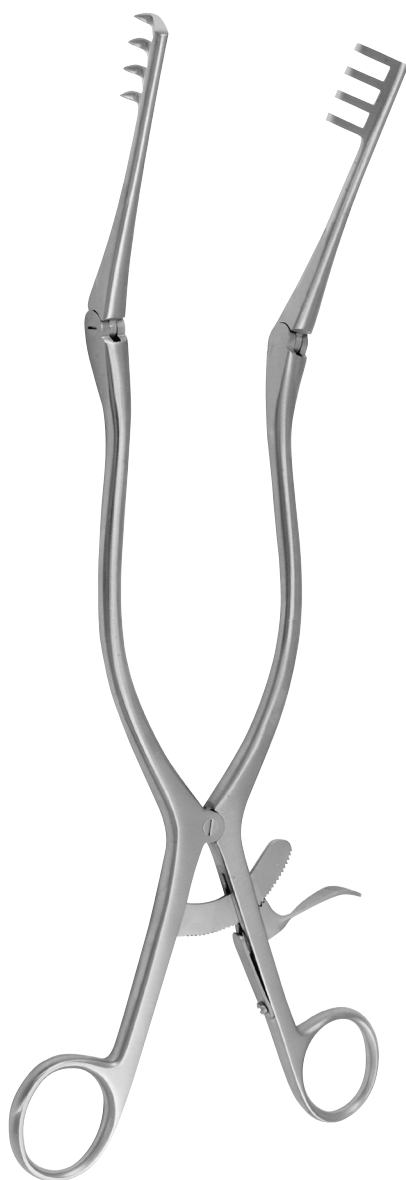

4 x 5

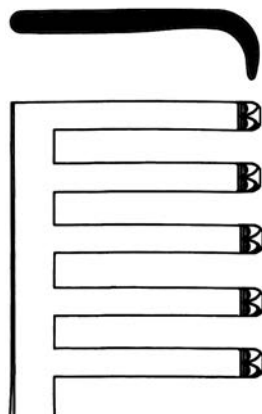

16-257-32

scharf
sharp
agudo
acuto

4 x 5

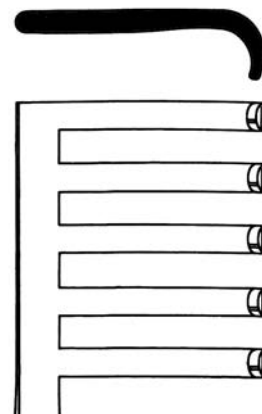

16-258-32

stumpf
blunt
romo
smusso

ADSON

16-257-32 - 16-258-32 32,0 cm, 12½"

4 x 4

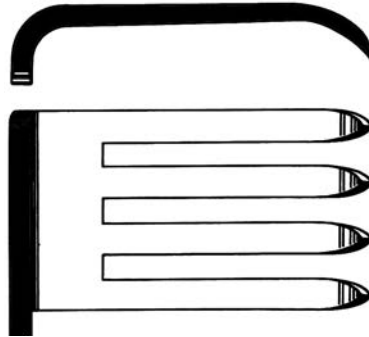

16-260-01

scharf
sharp
agudo
acuto

4 x 4

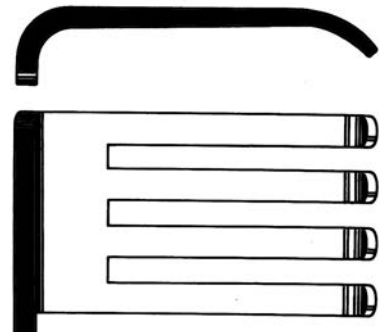

16-260-02

stumpf
blunt
romo
smusso



4 x 4

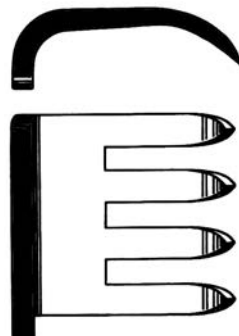

16-259-01

scharf
sharp
agudo
acuto

4 x 4

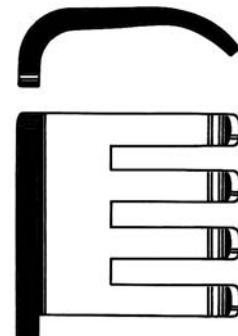

16-259-02

stumpf
blunt
romo
smusso

BECKMANN-ADSON

16-259-01 - 16-260-02 30,5 cm, 12 "

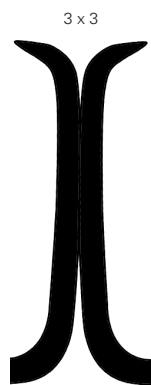

16-261-28

scharf
sharp
agudo
acuto

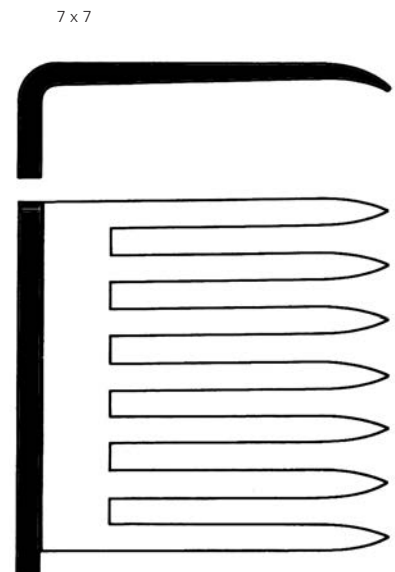
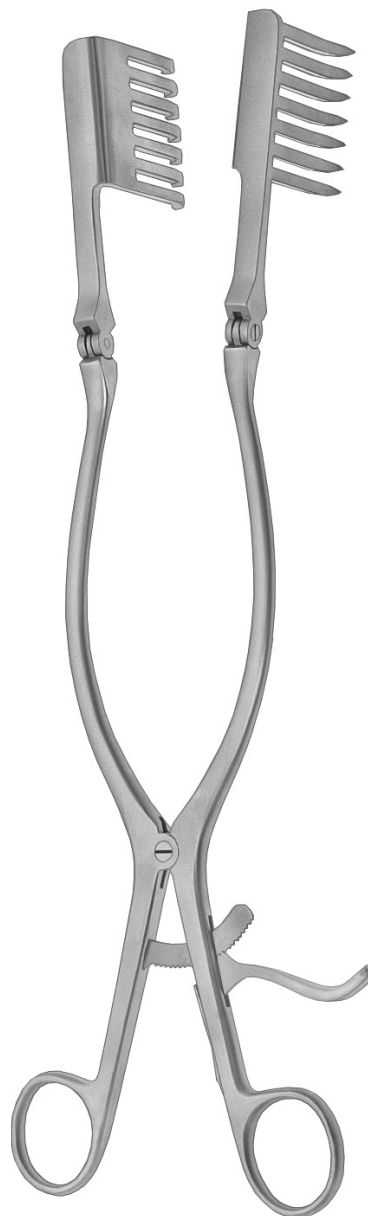

16-261-32

scharf
sharp
agudo
acuto

HARVEY-JACKSON

16-261-28 28,0 cm, 11 "

BECKMANN-EATON

16-261-32 32,0 cm, 12 ½ "

1 x 1

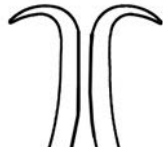

16-262-14

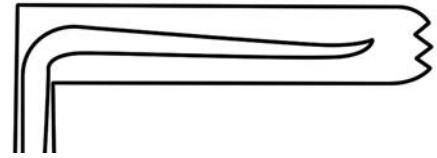

16-263-01	50 x 10 mm
16-263-02	60 x 10 mm
16-263-03	70 x 10 mm
16-263-04	50 x 20 mm
16-263-05	60 x 20 mm
16-263-06	70 x 20 mm

DE BAKEY

16-262-14 17,5 cm, 7 "

WILLIAMS

16-263-01 - 16-263-06 17,0 cm, 6 ¾ "



16-264-01	50 x 10 mm
16-264-02	60 x 10 mm
16-264-03	70 x 10 mm
16-264-04	50 x 20 mm
16-264-05	60 x 20 mm
16-264-06	70 x 20 mm

WILLIAMS

16-264-01 - 16-264-06 17,0 cm, 6 ¾ "



max. Spreizweite 210 mm
max. spread 210 mm
apertura máxima 210 mm
apertura massima 210 mm

ROBIN-MASSE

16-265-00



Seitenvalve 40 x 35 mm, halbscharf
Lateral valve 40 x 35 mm, semi-sharp
Valva laterales 40 x 35 mm, semi-agudo
Valve laterali 40 x 35 mm, semi-acuto

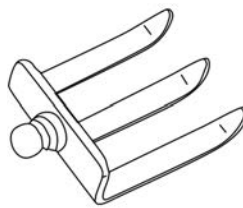

Seitenvalve 60 x 50 mm, stumpf
Lateral valve 60 x 50 mm, blunt
Valvas laterale 60 x 50 mm, romo
Valve laterali 60 x 50 mm, smusso

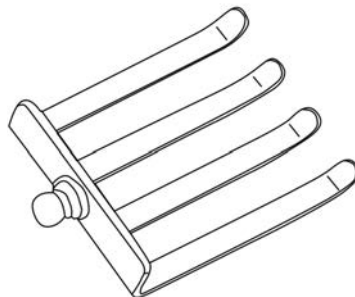

POPLITEA

16-266-02 SET



POPLITEA

16-266-00 SET



Komplett, bestehend aus:

1 Sperrer	16-266-01
1 Seitenvalven, paar	16-266-02

Complete, consisting of:

1 Retractor	16-266-01
1 Lateral valves, pair	16-266-02

Completo, compuesto de:

1 Separador	16-266-01
1 Valvas laterales, par	16-266-02

Completo, compuesto de:

1 Divaricatore	16-266-01
1 valve laterali, paio	16-266-02



max. Spreizweite 80 mm
max. spread 80 mm
apertura máxima 80 mm
apertura massima 80 mm

Seitenvalven, paar, 18 x 40 | 27 x 40 mm
Lateral valves, pair, 18 x 40 | 27 x 40 mm
Valvas laterale, par, 18 x 40 | 27 x 40 mm
Valve laterali, paio, 18 x 40 | 27 x 40 mm

BABY-COLLIN

16-267-00 20,0 cm, 8"



max. Spreizweite 100 mm
max. spread 100 mm
apertura máxima 100 mm
apertura massima 100 mm

Seitenvalve, 38 x 60 mm
Lateral valves, 38 x 60 mm
Valvas laterale, 38 x 60 mm
Valve laterali, 38 x 60 mm

COLLIN

16-268-00 24,0 cm, 9 1/2"



max. Spreizweite 100 mm
max. spread 100 mm
apertura máxima 100 mm
apertura massima 100 mm

COLLIN

16-270-00 23,0 cm, 9"

komplett, bestehend aus:
1 Sperrer mit Seitenvalven 38x60 mm
1 Mittelvalve 38x55 mm

complete, consisting of:
1 Spreader with lateral valves 38x60 mm
1 Central valve 38x55 mm

completo, compuesto de:
1 Separador con valvas laterales 38x60 mm
1 Valva central 38x55 mm

completo, composto da:
1 Divaricatore con valve laterali 38x60 mm
1 Valva centrale 38x55 mm



COLLIN

16-270-01 23,0 cm, 9"

komplett, bestehend aus:
1 Sperrer mit Seitenvalven 45x80 mm
1 Mittelvalve 50x75 mm

complete, consisting of:
1 Spreader with lateral valves 45x80 mm
1 Central valve 50x75 mm

completo, compuesto de:
1 Separador con valvas laterales 45x80 mm
1 Valva central 50x75 mm

completo, composto da:
1 Divaricatore con valve laterali 45x80 mm
1 Valva centrale 50x75 mm

COLLIN

16-270-02 23,0 cm, 9"

komplett, bestehend aus:
1 Sperrer mit Seitenvalven 37x98 mm
1 Mittelvalve 52x76 mm

complete, consisting of:
1 Spreader with lateral valves 37x98 mm
1 Central valve 52x76 mm

completo, compuesto de:
1 Separador con valvas laterales 37x98 mm
1 Valva central 52x76 mm

completo, composto da:
1 Divaricatore con valve laterali 37x98 mm
1 Valva centrale 52x76 mm



max. Spreizweite 150 mm
max. spread 150 mm
apertura máxima 150 mm
apertura massima 150 mm



COLLIN-LOKTITE

16-271-00 31,0 cm, 12 1/4"

komplett, bestehend aus:
1 Sperrer mit Seitenvalven 48x59 mm
1 Mittelvalve 63x74 mm

complete, consisting of:
1 Spreader with lateral valves 48x59 mm
1 Central valve 63x74 mm

completo, compuesto de:
1 Separador con valvas laterales 48x59 mm
1 Valva central 63x74 mm

completo, composto da:
1 Divaricatore con valve laterali 48x59 mm
1 Valva centrale 63x74 mm

COLLIN-LOKTITE

16-271-01 31,0 cm, 12 1/4"

komplett, bestehend aus:
1 Sperrer mit Seitenvalven 60x80 mm
1 Mittelvalve 60x75 mm

complete, consisting of:
1 Spreader with lateral valves 60x80 mm
1 Central valve 60x75 mm

completo, compuesto de:
1 Separador con valvas laterales 60x80 mm
1 Valva central 60x75 mm

completo, composto da:
1 Divaricatore con valve laterali 60x80 mm
1 Valva centrale 60x75 mm



Seitenvalven mit Kugelschnellverschluss, Paar
Lateral valves with ball snap closure, pair
Valvas laterales con cierre rápido esférico, par
Valve laterali a chiusura istantanea, paio



Seitenvalven mit Kugelschnellverschluss
Lateral valves with ball snap closure
Valvas laterales con cierre rápido esférico
Valve laterali a chiusura istantanea



Seitenvalven mit Kugelschnellverschluss
Lateral valves with ball snap closure
Valvas laterales con cierre rápido esférico
Valve laterali a chiusura istantanea

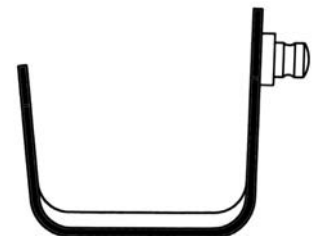
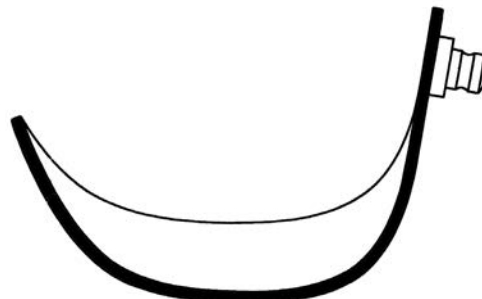

COLLIN

16-270-05	37 x 98 mm
16-270-07	49 x 59 mm
16-270-08	61 x 80 mm

16-273-50	50 x 70 mm
16-273-52	52 x 110 mm
16-273-70	70 x 55 mm
16-273-80	75 x 90 mm
16-273-90	50 x 58 mm
16-273-92	60 x 80 mm
16-273-94	72 x 58 mm

16-273-18	18 x 40 mm
16-273-27	27 x 40 mm
16-273-38	38 x 60 mm
16-273-40	40 x 80 mm
16-273-45	45 x 80 mm
16-273-60	60 x 80 mm



max. Spreizweite 300 mm
max. spread 300 mm
apertura máxima 300 mm
apertura massima 300 mm

max. Spreizweite 280 mm
max. spread 280 mm
apertura máxima 280 mm
apertura massima 280 mm



RICARD

16-272-00 28,0 cm, 11 "

komplett, bestehend aus:
1 Sperrer allein (16-272-01)
1 Paar Seitenvalven 60 x 80 mm
1 Mittelvalve 55 x 70 mm

complete, consisting of:
1 Spreader only (16-272-01)
1 Pair lateral valves 60 x 80 mm
1 Central valve 55 x 70 mm

completo, compuesto de:
1 Separador solo (16-272-01)
1 Par valvas laterales 60 x 80 mm
1 Valva central 55 x 70 mm

completo, composto da:
1 Divaricatore solo (16-272-01)
1 Paio valve laterali 60 x 80 mm
1 Valva centrale 55 x 70 mm

RICARD

16-273-00 28,0 cm, 11 "

komplett, bestehend aus:
1 Sperrer allein (16-272-01)
1 Paar Seitenvalven 72 x 85 mm
1 Mittelvalve 80 x 90 mm

complete, consisting of:
1 Spreader only (16-272-01)
1 Pair lateral valves 72 x 85 mm
1 Central valve 80 x 90 mm

completo, compuesto de:
1 Separador solo (16-272-01)
1 Par valvas laterales 72 x 85 mm
1 Valva central 80 x 90 mm

completo, composto da:
1 Divaricatore solo (16-272-01)
1 Paio valve laterali 72 x 85 mm
1 Valva centrale 80 x 90 mm



Seitenvalven mit Kugelschnellverschluss, Paar
Lateral valves with ball snap closure, pair
Valvas laterales con cierre rápido esférico, par
Valve laterali a chiusura istantanea, paio



RICARD

16-272-02 60 x 80 mm

16-272-03 72 x 85 mm



Mittelvalve mit Kugelschnellverschluss
Central valve with ball snap closure
Valvas central con cierre rápido esférico
Valve centrale a chiusura istantanea

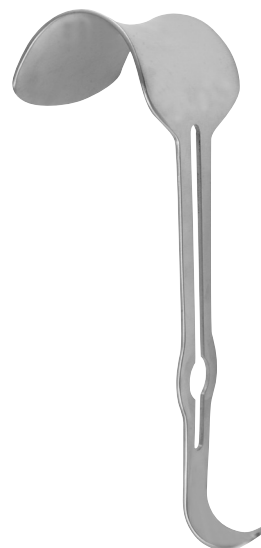

RICARD

16-272-04 55 x 70 mm

16-272-05 80 x 90 mm

max. Spreizweite 100 mm
max. spread 100 mm
apertura máxima 100 mm
apertura massima 100 mm

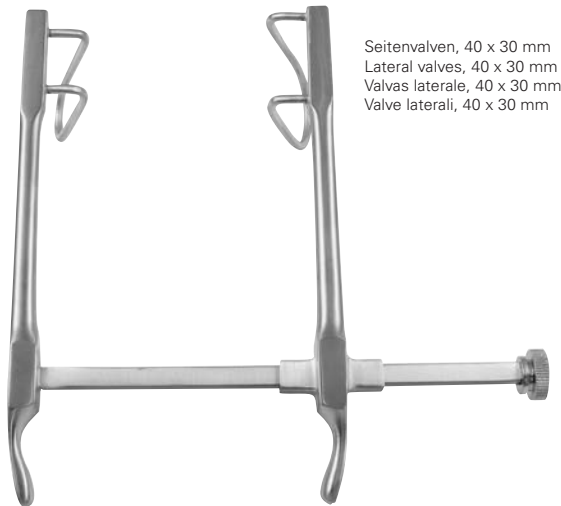

Seitenvalven, 40 x 30 mm
Lateral valves, 40 x 30 mm
Valvas laterale, 40 x 30 mm
Valve laterali, 40 x 30 mm

GOSSET-BABY

16-274-10 12,5 cm, 5 "

max. Spreizweite 140 mm
max. spread 140 mm
apertura máxima 140 mm
apertura massima 140 mm

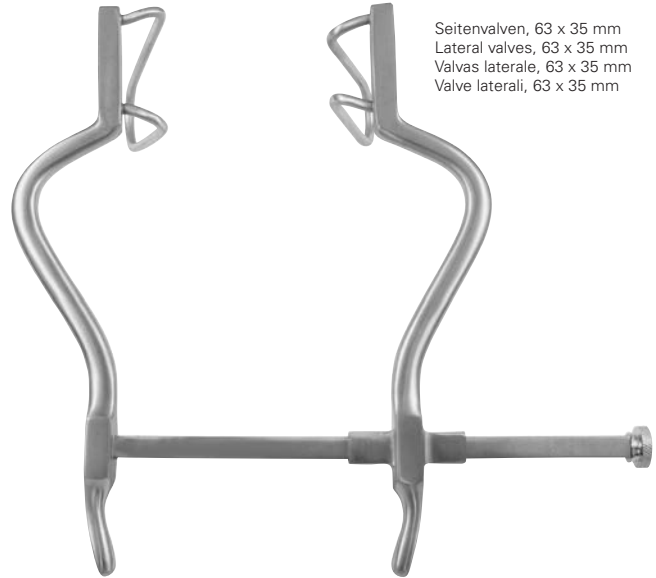

Seitenvalven, 63 x 35 mm
Lateral valves, 63 x 35 mm
Valvas laterale, 63 x 35 mm
Valve laterali, 63 x 35 mm

GOSSET

16-274-14 18,5 cm, 7 ¼ "

max. Spreizweite 160 mm
max. spread 160 mm
apertura máxima 160 mm
apertura massima 160 mm

Seitenvalven, 63 x 35 mm
Lateral valves, 63 x 35 mm
Valvas laterale, 63 x 35 mm
Valve laterali, 63 x 35 mm

Mittelvalve, 60 x 56 mm
Central valve, 60 x 56 mm
Valvas central, 60 x 56 mm
Valve centrale, 60 x 56 mm

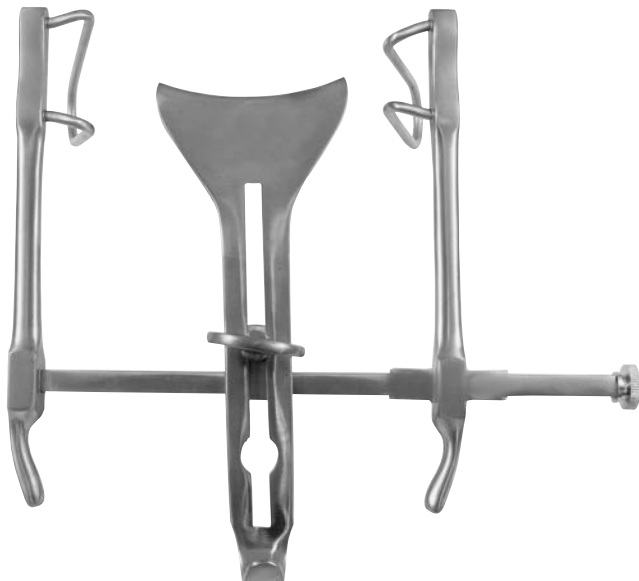

GOSSET

16-275-18 16,5 cm, 6 ½ "

Seitenvalven, 27 x 27 mm
Lateral valves, 27 x 27 mm
Valvas laterale, 27 x 27 mm
Valve laterali, 27 x 27 mm

Mittelvalve, 24 x 20 mm
Central valve, 24 x 20 mm
Valvas central, 24 x 20 mm
Valve centrale, 24 x 20 mm

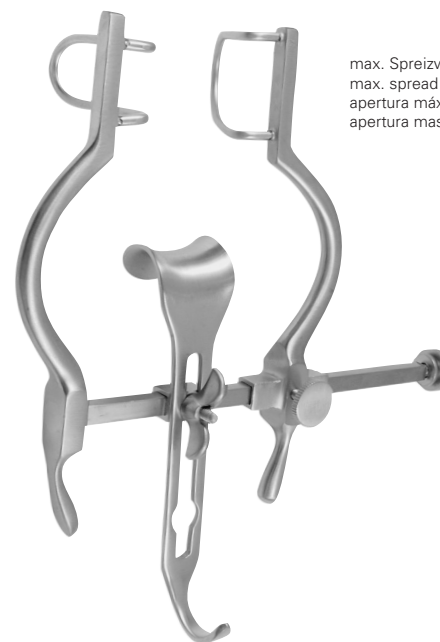

max. Spreizweite 90 mm
max. spread 90 mm
apertura máxima 90 mm
apertura massima 90 mm

BALFOUR-BABY

16-276-00 12,5 cm, 5 "

max. Spreizweite 180 mm
max. spread 180 mm
apertura máxima 180 mm
apertura massima 180 mm

Seitenvalven, 70 x 35 mm
Lateral valves, 70 x 35 mm
Valvas laterale, 70 x 35 mm
Valve laterali, 70 x 35 mm

max. Spreizweite 200 mm
max. spread 200 mm
apertura máxima 200 mm
apertura massima 200 mm

Seitenvalven, 100 x 35 mm
Lateral valves, 100 x 35 mm
Valvas laterale, 100 x 35 mm
Valve laterali, 100 x 35 mm

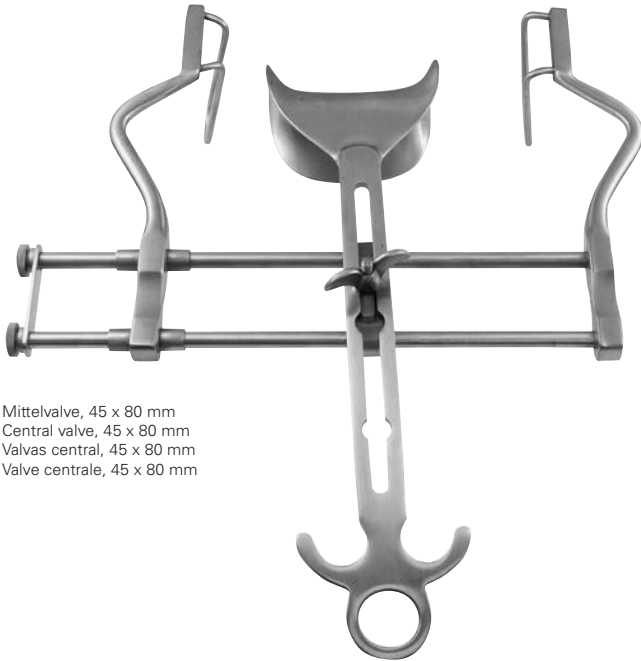

Mittelvalve, 45 x 80 mm
Central valve, 45 x 80 mm
Valvas central, 45 x 80 mm
Valve centrale, 45 x 80 mm

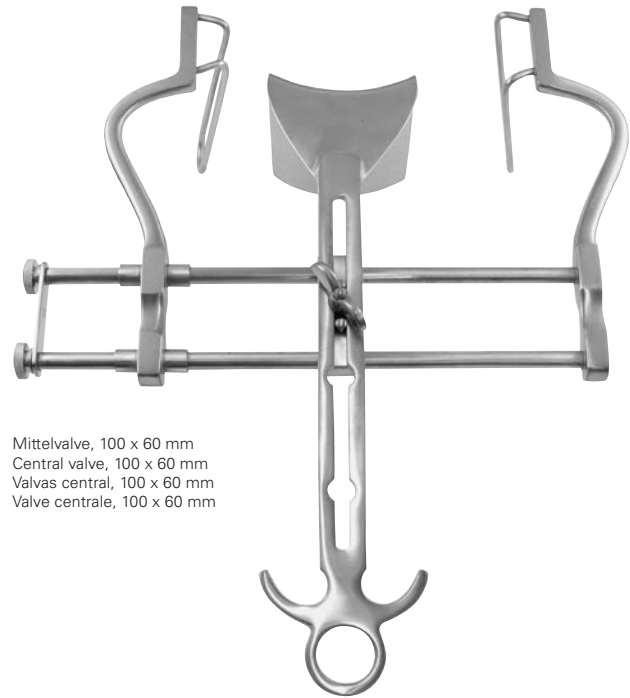

Mittelvalve, 100 x 60 mm
Central valve, 100 x 60 mm
Valvas central, 100 x 60 mm
Valve centrale, 100 x 60 mm

BALFOUR

16-277-18 20,0 cm, 8"

BALFOUR

16-277-20 20,0 cm, 8"

max. Spreizweite 250 mm
max. spread 250 mm
apertura máxima 250 mm
apertura massima 250 mm

Seitenvalven, 100 x 35 mm
Lateral valves, 100 x 35 mm
Valvas laterale, 100 x 35 mm
Valve laterali, 100 x 35 mm

Seitenvalven, 70 x 35 mm
Lateral valves, 70 x 35 mm
Valvas laterale, 70 x 35 mm
Valve laterali, 70 x 35 mm

max. Spreizweite 180 mm
max. spread 180 mm
apertura máxima 180 mm
apertura massima 180 mm

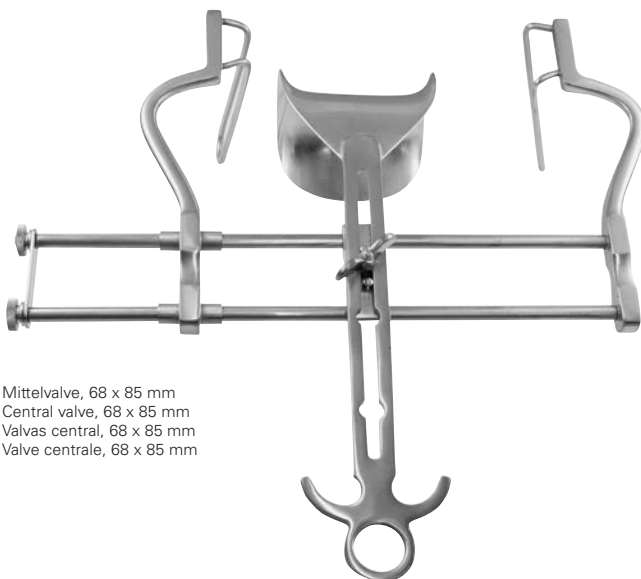

Mittelvalve, 68 x 85 mm
Central valve, 68 x 85 mm
Valvas central, 68 x 85 mm
Valve centrale, 68 x 85 mm



Mittelvalve, 45 x 80 mm
Central valve, 45 x 80 mm
Valvas central, 45 x 80 mm
Valve centrale, 45 x 80 mm

BALFOUR

16-277-25 20,0 cm, 8"

BALFOUR

16-278-18 20,0 cm, 8"

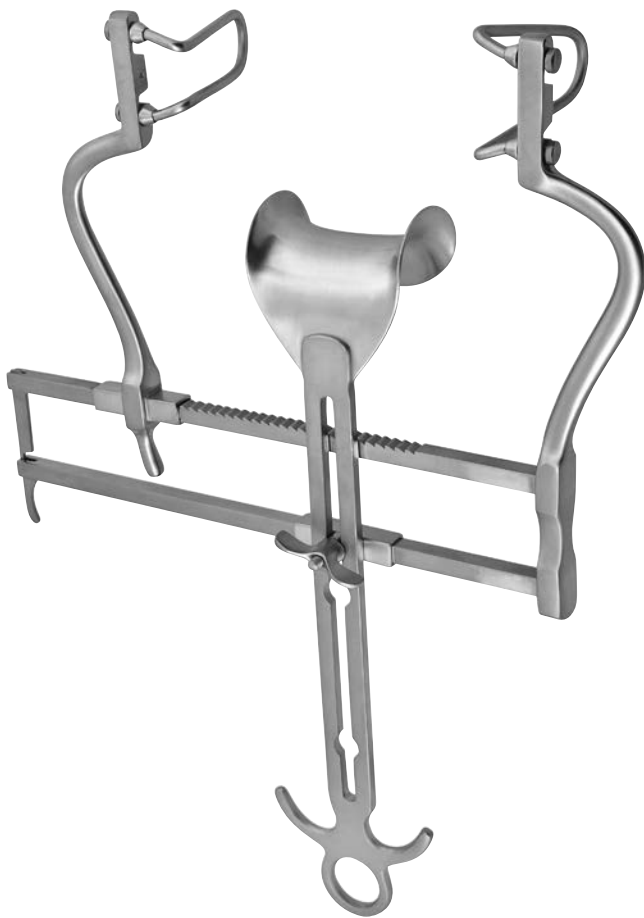

max. Spreizweite 250 mm
max. spread 250 mm
apertura máxima 250 mm
apertura massima 250 mm

Drahtvalven, tief, Paar
Fenestrated valves, deep, pair
Valvas de alambre de profundidad, par
Valve di fil profondità, paio



BALFOUR USA

16-279-10	60,0 mm
16-279-11	80,0 mm

BALFOUR USA

16-279-00 Set

komplett, bestehend aus:
1 Sperrer
1 Drahtvalven 60 mm, Paar
1 Drahtvalven 80 mm, Paar

complete, consisting of:
1 Spreader
1 Fenestrated valves 60 mm, pair
1 Fenestrated valves 80 mm, pair

completo, compuesto de:
1 Separador
1 Valvas de alambre 60 mm, par
1 Valvas de alambre 80 mm, par

completo, composto da:
1 Divaricatore
1 Valve di fil profondità 60 mm, paio
1 Valve di fil profondità 80 mm, paio

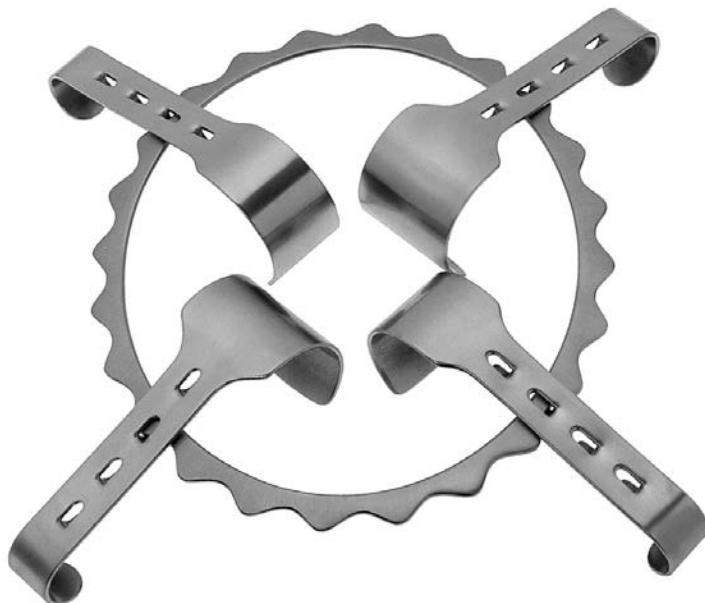

DENNIS-BROWNE

16-281-30	20 x 30 mm
16-281-32	20 x 40 mm
16-281-36	40 x 30 mm
16-281-40	40 x 40 mm

Valven, allein
Valves, only
Valvas, solo
Valve, suelto

DENNIS-BROWNE

16-281-15	175 x 150 mm
16-281-16	225 x 180 mm

Rahmen, allein
Frame, only
Cuadro, solo
Telaio, suelto

DENNIS-BROWNE

16-281-00 Set

komplett, bestehend aus:
1 Rahmen 175x150 mm (16-281-15)
2 Valven 40x30 mm (16-281-36)
2 Valven 40x40 mm (16-281-40)

complete, consisting of:
1 Frame 175x150 mm (16-281-15)
2 Valves 40x30 mm (16-281-36)
2 Valves 40x40 mm (16-281-40)

completo, compuesto de:
1 Cuadro 175x150 mm (16-281-15)
2 Valvas 40x30 mm (16-281-36)
2 Valvas 40x40 mm (16-281-40)

completo, composto da:
1 Telaio 175x150 mm (16-281-15)
2 Valve 40x30 mm (16-281-36)
2 Valve 40x40 mm (16-281-40)

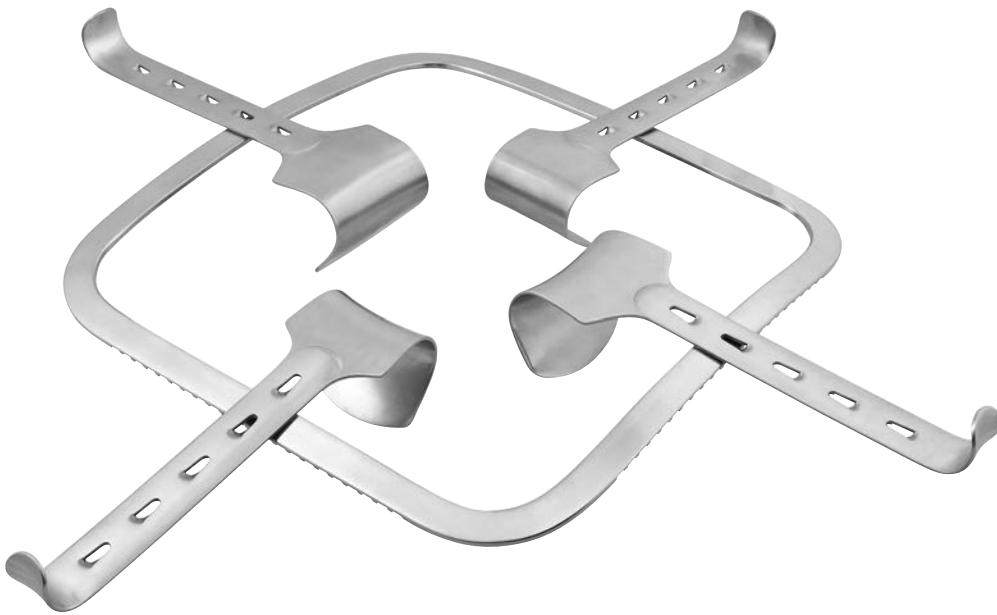

KIRSCHNER

16-283-24	240 x 240 mm
16-283-26	295 x 275 mm
16-283-27	275 x 355 mm

Rahmen, allein
Frame, only
Cuadro, solo
Telaio, suelto

KIRSCHNER

16-283-00 Set

komplett, bestehend aus:
1 Rahmen 240x240 mm (16-283-24)
2 Valven 40x55 mm (16-283-40)
2 Valven 50x65 mm (16-283-50)

complete, consisting of:
1 Frame 240x240 mm (16-283-24)
2 Valves 40x55 mm (16-283-40)
2 Valves 50x65 mm (16-283-50)

completo, compuesto de:
1 Cuadro 240x240 mm (16-283-24)
2 Valvas 40x55 mm (16-283-40)
2 Valvas 50x65 mm (16-283-50)

completo, composto da:
1 Telaio 240x240 mm (16-283-24)
2 Valve 40x55 mm (16-283-40)
2 Valve 50x65 mm (16-283-50)

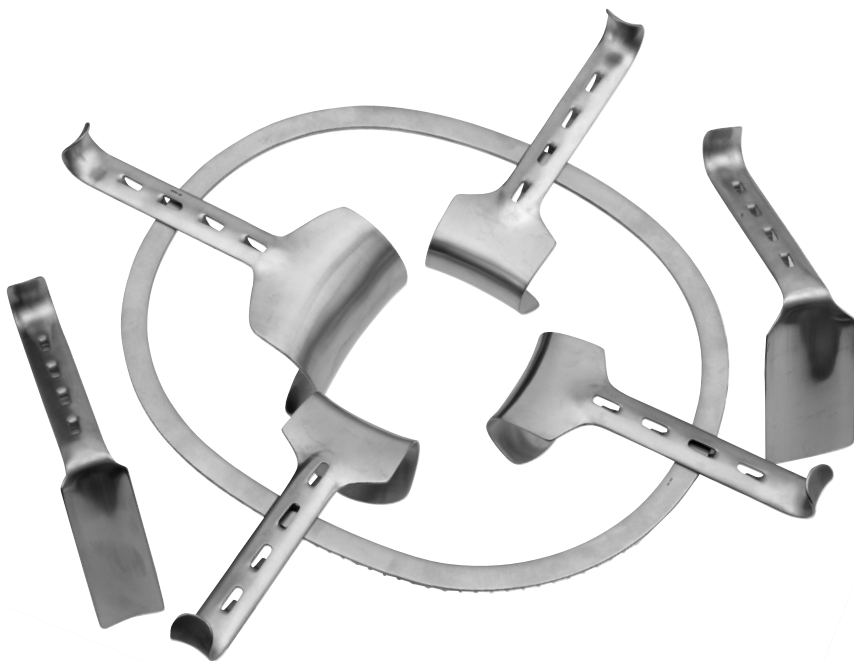

KIRSCHNER

16-284-30	340 x 240 mm
------------------	--------------

Rahmen, allein
Frame, only
Cuadro, solo
Telaio, suelto

KIRSCHNER

16-284-00 Set

komplett, bestehend aus:
1 Rahmen 340x240 mm (16-284-30)
3 Valven 50x65 mm (16-283-50)
1 Valve 80x90 mm (16-283-80)
1 Valve 98x50 mm (16-283-98)
1 Valve 105x35 mm (16-283-99)

complete, consisting of:
1 Frame 340x240 mm (16-284-30)
3 Valves 50x65 mm (16-283-50)
1 Valve 80x90 mm (16-283-80)
1 Valve 98x50 mm (16-283-98)
1 Valve 105x35 mm (16-283-99)

completo, compuesto de:
1 Cuadro 340x240 mm (16-284-30)
3 Valvas 50x65 mm (16-283-50)
1 Valva 80x90 mm (16-283-80)
1 Valva 98x50 mm (16-283-98)
1 Valva 105x35 mm (16-283-99)

completo, composto da:
1 Telaio 340x240 mm (16-284-30)
3 Valve 50x65 mm (16-283-50)
1 Valve 80x90 mm (16-283-80)
1 Valve 98x50 mm (16-283-98)
1 Valve 105x35 mm (16-283-99)

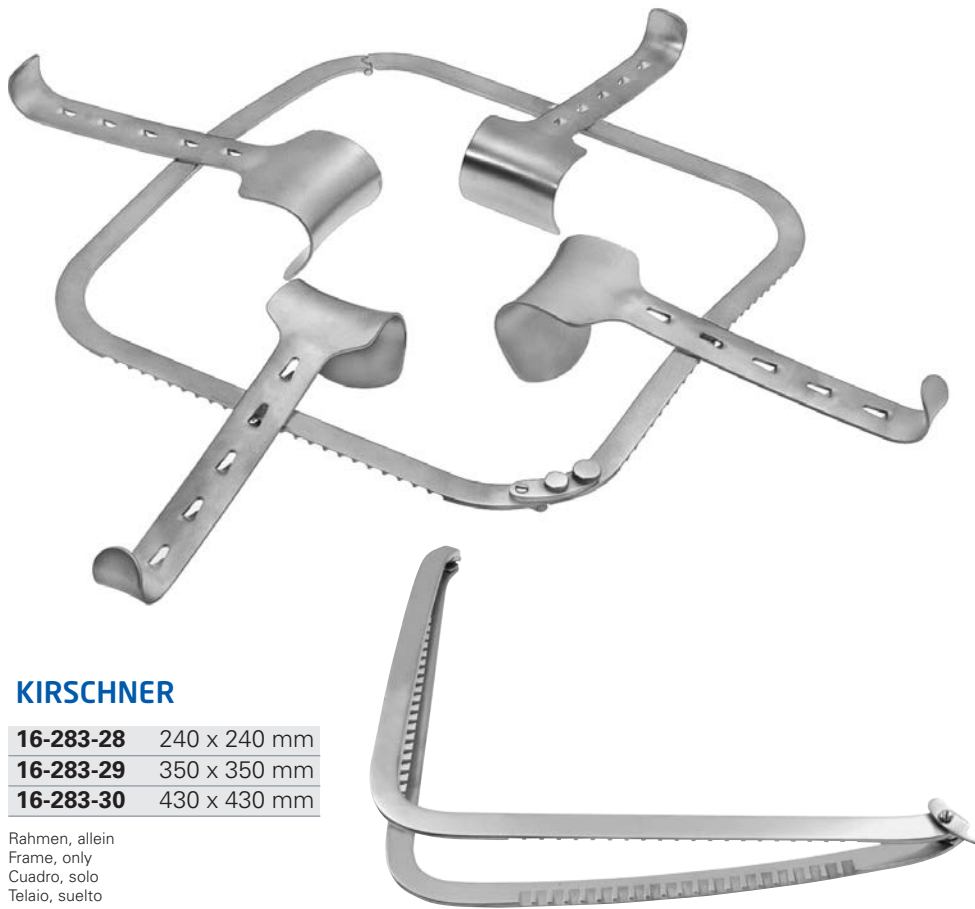

KIRSCHNER

16-283-28	240 x 240 mm
16-283-29	350 x 350 mm
16-283-30	430 x 430 mm

Rahmen, allein
Frame, only
Cuadro, solo
Telaio, suelto

KIRSCHNER

16-285-00 Set

komplett, bestehend aus:
1 Rahmen 240x240 mm (16-283-28)
2 Valven 40x55 mm (16-283-40)
2 Valven 50x65 mm (16-283-50)

complete, consisting of:
1 Frame 240x240 mm (16-283-28)
2 Valves 40x55 mm (16-283-40)
2 Valves 50x65 mm (16-283-50)

completo, compuesto de:
1 Cuadro 240x240 mm (16-283-28)
2 Valvas 40x55 mm (16-283-40)
2 Valvas 50x65 mm (16-283-50)

completo, composto da:
1 Telaio 240x240 mm (16-283-28)
2 Valve 40x55 mm (16-283-40)
2 Valve 50x65 mm (16-283-50)



KIRSCHNER

16-283-40	40 x 55 mm
16-283-50	50 x 65 mm
16-283-78	78 x 65 mm
16-283-80	80 x 90 mm



KIRSCHNER

16-283-60	60 x 85 mm
------------------	------------



KIRSCHNER

16-283-98	98 x 50 mm
16-283-99	105 x 35 mm



FRANZ

16-286-00 Set

komplett, bestehend aus:
1 Rahmen 300x300 mm
2 Valven 38x60 mm
2 Valven 50x65 mm

complete, consisting of:
1 Frame 300x300 mm
2 Valves 38x60 mm
2 Valves 50x65 mm

completo, compuesto de:
1 Cuadro 300x300 mm
2 Valvas 38x60 mm
2 Valvas 50x65 mm

completo, composto da:
1 Telaio 300x300 mm
2 Valve 38x60 mm
2 Valve 50x65 mm

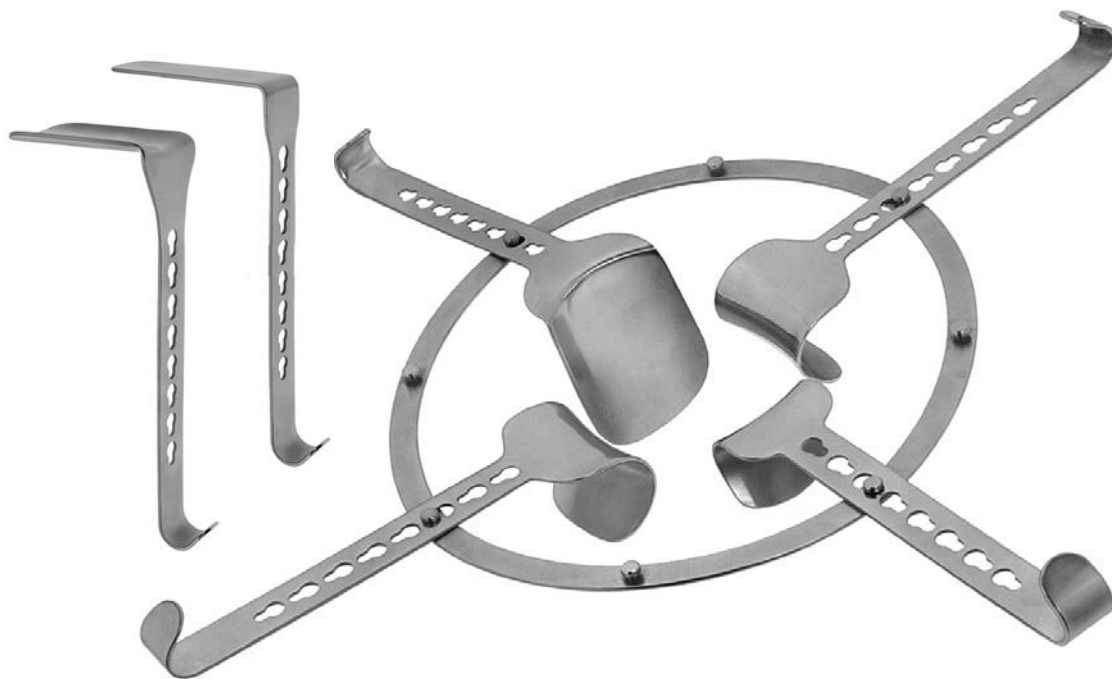

SEMM

16-290-09 255 x 220 mm

Rahmen, allein
Frame, only
Cuadro, solo
Telaio, suelto

SEMM

16-290-00 Set

komplett, bestehend aus:
1 Rahmen 255x220 mm (16-290-09)
2 Valven 46x64 mm (16-290-01)
1 Valve 53x54 mm (16-290-02)
1 Valve 82x97 mm (16-290-03)
1 Valve 96x51 mm (16-290-04)
1 Valve 107x36 mm (16-290-05)

complete, consisting of:
1 Frame 255x220 mm (16-290-09)
2 Valves 46x64 mm (16-290-01)
1 Valve 53x54 mm (16-290-02)
1 Valve 82x97 mm (16-290-03)
1 Valve 96x51 mm (16-290-04)
1 Valve 107x36 mm (16-290-05)

completo, compuesto de:
1 Cuadro 255x220 mm (16-290-09)
2 Valvas 46x64 mm (16-290-01)
1 Valva 53x54 mm (16-290-02)
1 Valva 82x97 mm (16-290-03)
1 Valva 96x51 mm (16-290-04)
1 Valva 107x36 mm (16-290-05)

completo, composto da:
1 Telaio 255x220 mm (16-290-09)
2 Valve 46x64 mm (16-290-01)
1 Valva 53x54 mm (16-290-02)
1 Valva 82x97 mm (16-290-03)
1 Valva 96x51 mm (16-290-04)
1 Valva 107x36 mm (16-290-05)



CHARNLEY

16-293-00 Set

komplett, bestehend aus:
1 Rahmen 320x230 mm
2 Valven

complete, consisting of:
1 Frame 320x230 mm
2 Valves

completo, compuesto de:
1 Cuadro 320x230 mm
2 Valvas

completo, composto da:
1 Telaio 320x230 mm
2 Valve

CHARNLEY

16-293-10 320 x 230 mm

Rahmen, allein
Frame, only
Cuadro, solo
Telaio, suelto



HOLZBACH

16-295-00 SET

komplett, bestehend aus:
1 Sperrer allein (16-295-05)
1 Paar Seitenvalven 59 x 80 mm (16-295-02)
1 Mittelvalve 74 x 82 mm (16-295-01)

complete, consisting of:
1 Spreader only (16-295-05)
1 Pair lateral valves 59 x 80 mm (16-295-02)
1 Central valve 74 x 82 mm (16-295-01)

completo, compuesto de:
1 Separador solo (16-295-05)
1 Par valvas laterales 59 x 80 mm (16-295-02)
1 Valva central 74 x 82 mm (16-295-01)

completo, composto da:
1 Divaricatore solo (16-295-05)
1 Paio valve laterali 59 x 80 mm (16-295-02)
1 Valva centrale 74 x 82 mm (16-295-01)

HOLZBACH

16-295-05

Sperrer, allein
Spreader, only
Separador, solo
Divaricatore, solo

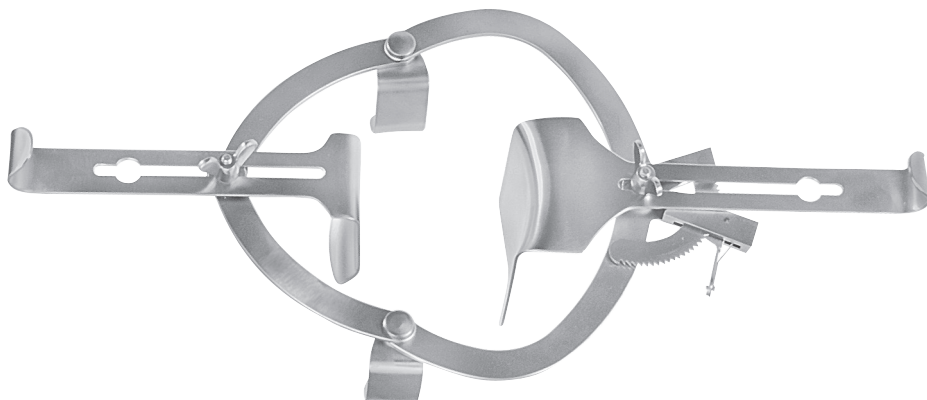

O'SULLIVAN-O'CONNOR

16-296-00 SET

komplett, bestehend aus:
1 Rahmen mit 2 Seitenvalven 60x25 mm
1 Valve 80x45 mm
1 Valve 110x70 mm

complete, consisting of:
1 Frame with 2 lateral valves 60x25 mm
1 Valve 80x45 mm
1 Valve 110x70 mm

completo, compuesto de:
1 Cuadro con 2 valvas laterales 60x25 mm
1 Valva 80x45 mm
1 Valva 110x70 mm

completo, composto da:
1 Telaio con 2 valve laterali 60x25 mm
1 Valva 80x45 mm
1 Valva 110x70 mm

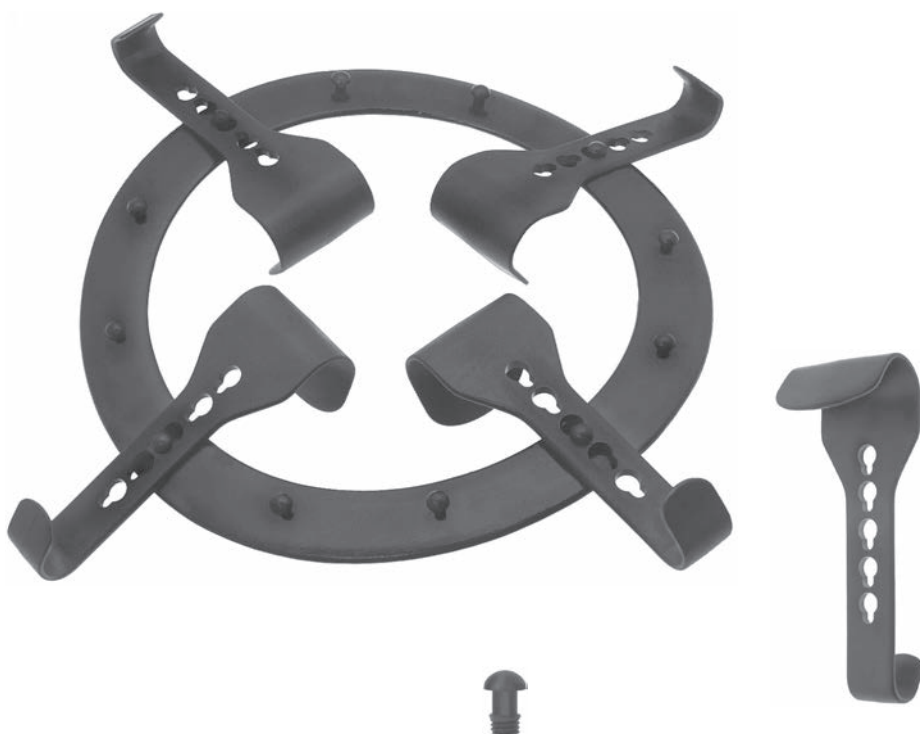

16-298-00 SET

komplett, bestehend aus:
1 Rahmen Ø 255 mm (16-298-25)
4 Valven 50x65 mm (16-298-05)

complete, consisting of:
1 Frame Ø 255 mm (16-298-25)
4 Valves 50x65 mm (16-298-05)

completo, compuesto de:
1 Cuadro Ø 255 mm (16-298-25)
4 Valvas 50x65 mm (16-298-05)

completo, composto da:
1 Telaio Ø 255 mm (16-298-25)
4 Valve 50x65 mm (16-298-05)

16-298-25 Ø 255 mm

Rahmen, allein
Frame, only
Cuadro, solo
Telaio, suelto



16-298-98 M 6

Ersatzknopf, allein
Spare button, only
Botón de repuesto, solo
Bottone di ricambio, suelto



16-298-05 50 x 65 mm

16-298-07 75 x 65 mm

Valven, allein
Valves, only
Valvas, solo
Valve, suelto





ROCHARD

16-300-01 660 x 530 mm



ROCHARD

16-300-02 660 x 530 mm



ROCHARD

16-300-05 19,5 cm, 7 3/4 "

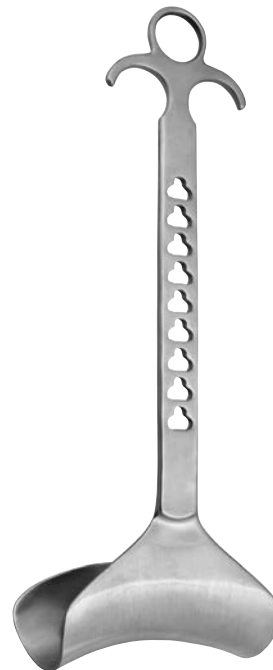

ROCHARD

16-300-09	50 x 90 mm
16-300-10	50 x 105 mm
16-300-12	50 x 120 mm
16-300-13	50 x 135 mm
16-300-15	50 x 155 mm



ohne Universalkloben
without universal clamp
sin soporte universal
senza supporto universal

16-310-00 SET

Arm-System, bestehend aus:
1 L -Stativ 470 x 170 mm, Radius 310 mm
1 Universale Wundhakenhalterung (16-322-01)

Arm system, consisting of:
1 L -stand 470 x 170 mm, radius 310 mm
1 Universal retractor holder (16-322-01)

Sistema brazo, compuesto de:
1 L -trípode 470 x 170 mm, radio 310 mm
1 Separadores soporte universal (16-322-01)

Sistema braccio, composto da:
1 L -stativo 470 x 170 mm, raggio 310 mm
1 Supporto per divaricatori universal (16-322-01)



ohne Universalkloben
without universal clamp
sin soporte universal
senza supporto universal

16-314-00 SET

Arm-System, bestehend aus:
1 Geradem Stativ 300 mm, Radius 400 mm
1 Universale Endoskophalterung (16-322-02)

Arm system, consisting of:
1 Straight stand 300 mm, radius 400 mm
1 Universal endoscope holder (16-322-02)

Sistema brazo, compuesto de:
1 Tripode recto 300 mm, radio 400 mm
1 Universal endoscopia soporte (16-322-02)

Sistema braccio, composto da:
1 Stativo retto 300 mm, raggio 400 mm
1 Universal supporto per endoscopio (16-322-02)

Universalkloben Spannweite 50 mm,
 isoliert bis 4,5 kV

Universal clamp, holding width 50 mm,
 insulated up to 4,5 kV

Soporte universal, extensión 50 mm,
 aislado hasta 4,5 kV

Supporto universal, apertura 50 mm,
 isolato fino a 4,5 kV



16-320-00 Ø 16,0 mm

STEEL
 STAINLESS

Universalkloben, Spannweite 50 mm
 Universal clamp, holding width 50 mm
 Soporte universal, extensión 50 mm
 Supporto universal apertura 50 mm



16-321-00 Ø 16,0 mm

AL
 ALUMINIUM

Universale Wundhakenhalterung
 Universal retractor holder
 Separadores soporte universal
 Supporto per divaricatori universal



16-322-01

Universale Endoskophalterung
 Universal endoscope holder
 Universal endoscopio soporte
 Universal supporto per endoscopio



16-322-02 Ø 2,7-4,0 mm

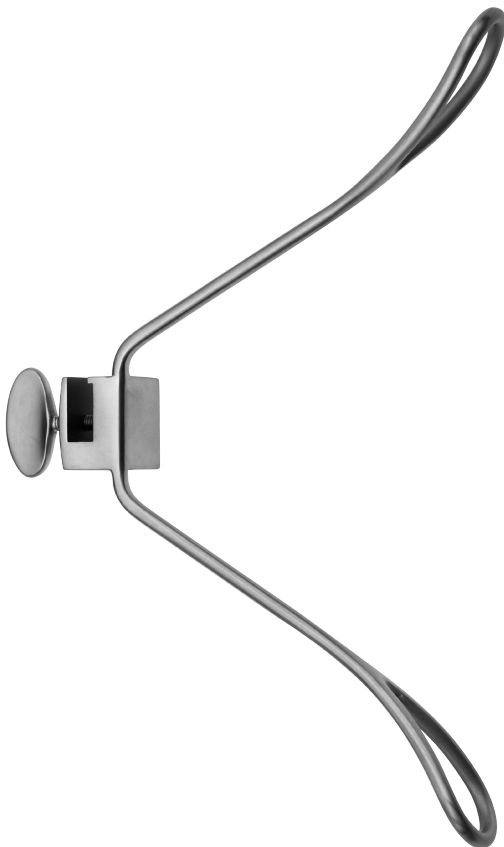

DOYEN-CHILD

16-330-00 22,5 cm, 8 ¾"



DOYEN

16-330-01	55 x 95 mm
16-330-02	55 x 105 mm
16-330-03	55 x 115 mm
16-330-04	55 x 125 mm

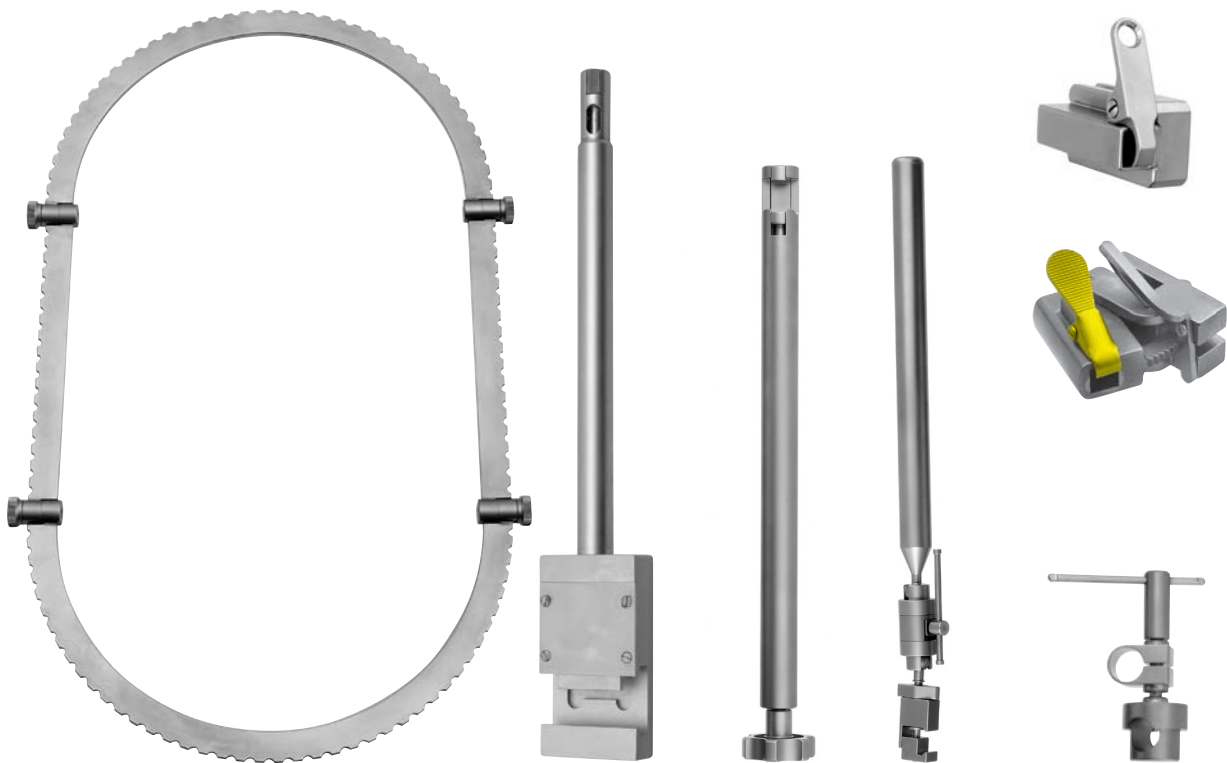

16-500-00 SET

Abdominal KIT II, bestehend aus:

- 1 Tischstativ (16-501-01)
- 1 Spanngelenk für 2 x 25 mm Rohre (16-501-02)
- 1 Rahmenhalter Ø 25 mm, Länge 36,5 cm (16-501-03)
- 1 Flexibler Haltearm, 360° drehbar (16-501-04)
- 2 Standard Fixierschlitten, 4 cm (16-501-06)
- 6 Tiltschlitten mit Verstellmechanismus (16-501-07)
- 1 Ovalrahmen, medium, 267 x 368 mm (16-502-02)
- 1 Rundrahmen, medium 266 x 495 mm (16-505-02)
- 1 BALFOUR Wundhaken 67 x 76 mm (16-510-01)
- 1 GELPI Wundhaken, mit Dorn (16-512-01)
- 1 HARRINGTON Wundhaken 63 x 143 mm (16-513-01)
- 2 KELLY Wundhaken, 51 x 76 mm (16-515-04)
- 1 KELLY Wundhaken, 51 x 101 mm (16-515-05)
- 1 KELLY Wundhaken, 51 x 127 mm (16-515-06)
- 1 KELLY Wundhaken, 51 x 152 mm (16-515-07)
- 1 Wundhaken, biegsam, 38 x 152 mm (16-516-01)
- 2 Wundhaken, biegsam, 51 x 152 mm (16-516-02)
- 1 Wundhaken, biegsam, 76 x 152 mm (16-516-03)

Abdominal KIT II, compuesto de:

- 1 Fijación de mesa (16-501-01)
- 1 Acoplamiento 25 mm (16-501-02)
- 1 Barra horizontal Ø 25 mm, 36,5 cm (16-501-03)
- 1 Barra horizontal con articulación esférica, 360° (16-501-04)
- 2 Soporte para separador, 4 cm (16-501-06)
- 6 Soporte para separador, inclinable, 4 cm (16-501-07)
- 1 Cerco, oval, medio, 267 x 368 mm (16-502-02)
- 1 Cerco, redondo, medio 266 x 495 mm (16-505-02)
- 1 BALFOUR separador 67 x 76 mm (16-510-01)
- 1 GELPI separador, con pincho (16-512-01)
- 1 HARRINGTON separador 63 x 143 mm (16-513-01)
- 2 KELLY separador, 51 x 76 mm (16-515-04)
- 1 KELLY separador, 51 x 101 mm (16-515-05)
- 1 KELLY separador, 51 x 127 mm (16-515-06)
- 1 KELLY separador, 51 x 152 mm (16-515-07)
- 1 Separador, maleables, 38 x 152 mm (16-516-01)
- 2 Separador, maleables, 51 x 152 mm (16-516-02)
- 1 Separador, maleables, 76 x 152 mm (16-516-03)

Abdominal KIT II, consisting of:

- 1 Table post (16-501-01)
- 1 Post coupling for 2 x 25 mm bars (16-501-02)
- 1 Horizontal bar Ø 25 mm, length 36,5 cm (16-501-03)
- 1 Horizontal flex bar, 360° rotatable (16-501-04)
- 2 Ratchet mechanisms, 4 cm (16-501-06)
- 6 Tilt ratchet mechanisms (16-501-07)
- 1 Oval ring, medium, 267 x 368 mm (16-502-02)
- 1 Segmented ring, medium 266 x 495 mm (16-505-02)
- 1 BALFOUR retractor 67 x 76 mm (16-510-01)
- 1 GELPI retractor, with pin (16-512-01)
- 1 HARRINGTON retractor 63 x 143 mm (16-513-01)
- 2 KELLY retractor, s 51 x 76 mm (16-515-04)
- 1 KELLY retractor, 51 x 101 mm (16-515-05)
- 1 KELLY retractor, 51 x 127 mm (16-515-06)
- 1 KELLY retractor, 51 x 152 mm (16-515-07)
- 1 Retractor, malleable, 38 x 152 mm (16-516-01)
- 2 Retractors, malleable, 51 x 152 mm (16-516-02)
- 1 Retractor, malleable, 76 x 152 mm (16-516-03)

Abdominal KIT II, composto da:

- 1 Fissaggio per tavola (16-501-01)
- 1 Aggancio 25 mm (16-501-02)
- 1 Asta orizzontale Ø 25 mm, 36,5 cm (16-501-03)
- 1 Asta orizzontale con articolazione sferica, 360° (16-501-04)
- 2 Supporto per divaricatore, 4 cm (16-501-06)
- 6 Supporto per divaricatore, inclinabile, 4 cm (16-501-07)
- 1 Cornice, ovale, medio, 267 x 368 mm (16-502-02)
- 1 Cornice, tondo, medio 266 x 495 mm (16-505-02)
- 1 BALFOUR divaricatore 67 x 76 mm (16-510-01)
- 1 GELPI divaricatore, con spina (16-512-01)
- 1 HARRINGTON divaricatore 63 x 143 mm (16-513-01)
- 2 KELLY divaricatore, 51 x 76 mm (16-515-04)
- 1 KELLY divaricatore, 51 x 101 mm (16-515-05)
- 1 KELLY divaricatore, 51 x 127 mm (16-515-06)
- 1 KELLY divaricatore, 51 x 152 mm (16-515-07)
- 1 Divaricatore, melleabili, 38 x 152 mm (16-516-01)
- 2 Divaricatore, melleabili, 51 x 152 mm (16-516-02)
- 1 Divaricatore, melleabili, 76 x 152 mm (16-516-03)



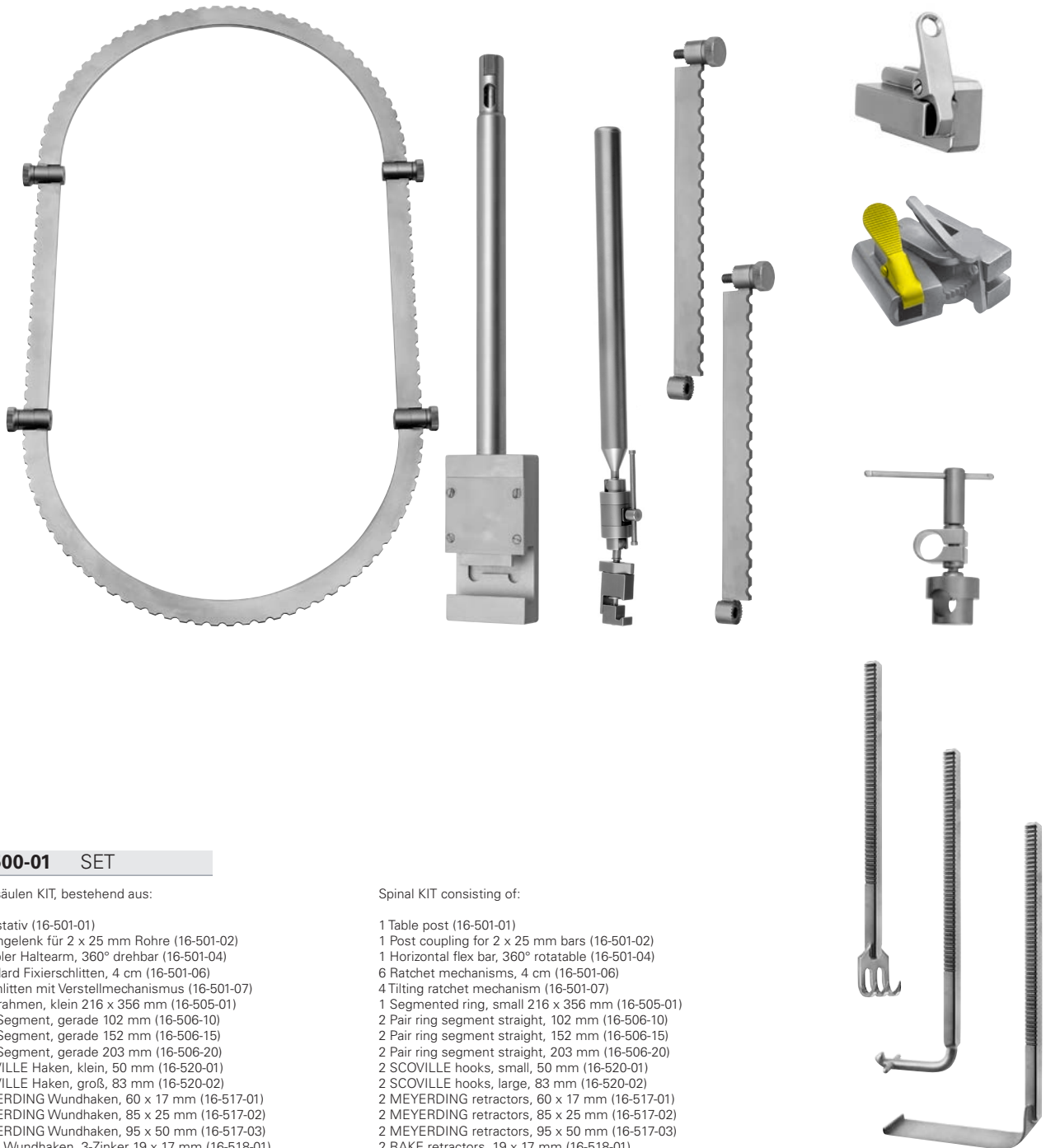

16-500-01 SET

Wirbelsäulen KIT, bestehend aus:

- 1 Tischstativ (16-501-01)
- 1 Spanngelenk für 2 x 25 mm Rohre (16-501-02)
- 1 Flexibler Haltearm, 360° drehbar (16-501-04)
- 6 Standard Fixierschlitten, 4 cm (16-501-06)
- 4 Tiltschlitten mit Verstellmechanismus (16-501-07)
- 1 Rundrahmen, klein 216 x 356 mm (16-505-01)
- 2 Paar Segment, gerade 102 mm (16-506-10)
- 2 Paar Segment, gerade 152 mm (16-506-15)
- 2 Paar Segment, gerade 203 mm (16-506-20)
- 2 SCOVILLE Haken, klein, 50 mm (16-520-01)
- 2 SCOVILLE Haken, groß, 83 mm (16-520-02)
- 2 MEYERDING Wundhaken, 60 x 17 mm (16-517-01)
- 2 MEYERDING Wundhaken, 85 x 25 mm (16-517-02)
- 2 MEYERDING Wundhaken, 95 x 50 mm (16-517-03)
- 2 RAKE Wundhaken, 3-Zinker 19 x 17 mm (16-518-01)
- 2 RAKE Wundhaken, 4-Zinker 8,4 x 19 mm (16-518-02)
- 2 RAKE Wundhaken, 6-Zinker 8,4 x 25 mm (16-518-03)

Columna vertebral KIT, compuesto de:

- 1 Fijación de mesa (16-501-01)
- 1 Acoplamiento 25 mm (16-501-02)
- 1 Barra horizontal con articulación esférica, 360° (16-501-04)
- 6 Soporte para separador, 4 cm (16-501-06)
- 4 Soporte para separador, inclinable, 4 cm (16-501-07)
- 1 Cerco, redondo, pequeño 216 x 356 mm (16-505-01)
- 2 Segmento, derecha 102 mm (16-506-10)
- 2 Segmento, derecha 152 mm (16-506-15)
- 2 Segmento, derecha 203 mm (16-506-20)
- 2 SCOVILLE gancho, 50 mm (16-520-01)
- 2 SCOVILLE gancho, 83 mm (16-520-02)
- 2 MEYERDING separador, 60 x 17 mm (16-517-01)
- 2 MEYERDING separador, 85 x 25 mm (16-517-02)
- 2 MEYERDING separador, 95 x 50 mm (16-517-03)
- 2 RAKE separador, 3 pincho 19 x 17 mm (16-518-01)
- 2 RAKE separador, 4 pincho 8,4 x 19 mm (16-518-02)
- 2 RAKE separador, 6 pincho 8,4 x 25 mm (16-518-03)

Spinal KIT consisting of:

- 1 Table post (16-501-01)
- 1 Post coupling for 2 x 25 mm bars (16-501-02)
- 1 Horizontal flex bar, 360° rotatable (16-501-04)
- 6 Ratchet mechanisms, 4 cm (16-501-06)
- 4 Tilting ratchet mechanism (16-501-07)
- 1 Segmented ring, small 216 x 356 mm (16-505-01)
- 2 Pair ring segment straight, 102 mm (16-506-10)
- 2 Pair ring segment straight, 152 mm (16-506-15)
- 2 Pair ring segment straight, 203 mm (16-506-20)
- 2 SCOVILLE hooks, small, 50 mm (16-520-01)
- 2 SCOVILLE hooks, large, 83 mm (16-520-02)
- 2 MEYERDING retractors, 60 x 17 mm (16-517-01)
- 2 MEYERDING retractors, 85 x 25 mm (16-517-02)
- 2 MEYERDING retractors, 95 x 50 mm (16-517-03)
- 2 RAKE retractors, 19 x 17 mm (16-518-01)
- 2 RAKE retractors, 8,4 x 19 mm (16-518-02)
- 2 RAKE retractors, 8,4 x 25 mm (16-518-03)

Colonna vertebrale KIT, bestehend aus:

- 1 Fissaggio per tavola (16-501-01)
- 1 Aggancio 25 mm (16-501-02)
- 1 Asta orizzontale con articolazione sferica, 360° (16-501-04)
- 6 Supporto per divaricatore, 4 cm (16-501-06)
- 4 Supporto per divaricatore, inclinabile, 4 cm (16-501-07)
- 1 Cornice, tondo, piccolo 216 x 356 mm (16-505-01)
- 2 Segmento, retto 102 mm (16-506-10)
- 2 Segmento, retto 152 mm (16-506-15)
- 2 Segmento, retto 203 mm (16-506-20)
- 2 SCOVILLE uncini, 50 mm (16-520-01)
- 2 SCOVILLE uncini, 83 mm (16-520-02)
- 2 MEYERDING divaricatore, 60 x 17 mm (16-517-01)
- 2 MEYERDING divaricatore, 85 x 25 mm (16-517-02)
- 2 MEYERDING divaricatore, 95 x 50 mm (16-517-03)
- 2 RAKE divaricatore, 3 spina 19 x 17 mm (16-518-01)
- 2 RAKE divaricatore, 4 spina 8,4 x 19 mm (16-518-02)
- 2 RAKE divaricatore, 6 spina 8,4 x 25 mm (16-518-03)

Tischstativ
Table post
Fijación de mesa
Fissaggio per tavola



16-501-01 25,0 mm

Spanngelenk
Post coupling
Acoplamiento
Aggancio



16-501-02 2 x 25,0 mm

Rahmenhalter Ø 25 mm
Horizontal bar Ø 25 mm
Barra horizontal Ø 25 mm
Asta orizzontale Ø 25 mm



16-501-03 36,5 cm, 14 1/3"

Flexibler Haltearm, 360° drehbar
Horizontal flex bar, 360° rotatable
Barra horizontal con articulación
esférica, 360°
Asta orizzontale con articolazione
sférica, 360°



16-501-04

Verlängerung
Extension bar
Alargamiento
Prolungamento



16-501-05 30,5 cm, 12"

Standard Fixierschlitten
Standard ratchet mechanism
Soporte para separador
Supporto per divaricatore



16-501-06 4,0 cm, 1 1/2"

Tiltschlitten mit Verstellmechanismus
Tilting ratchet mechanism
Soporte para separador, inclinable
Supporto per divaricatore, inclinabile



16-501-07 4,0 cm, 1 1/2"

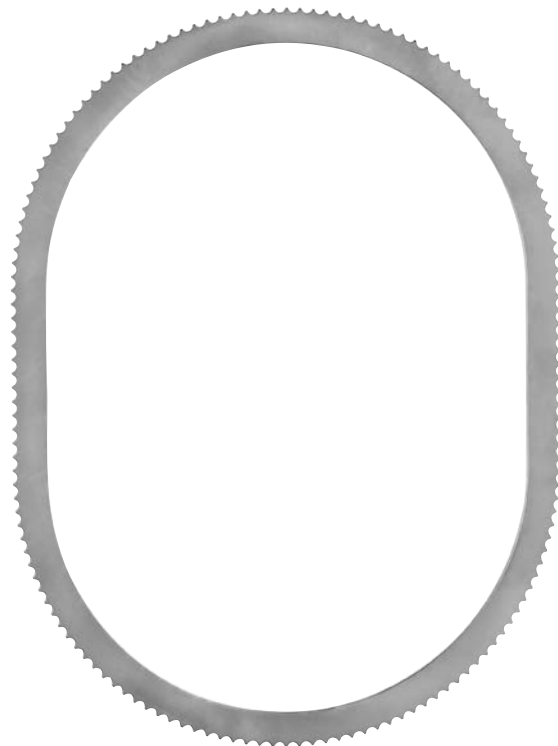

16-502-01 203 x 311 mm

16-502-02 267 x 368 mm

16-502-03 267 x 470 mm

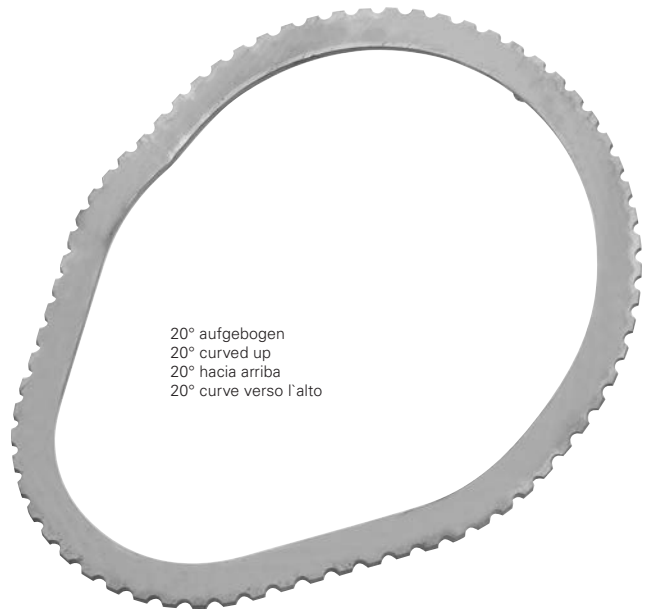
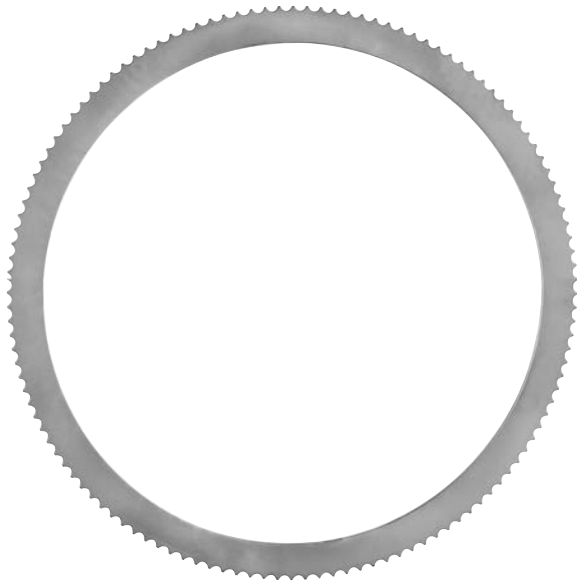

16-503-01	Ø 216 mm
16-503-02	Ø 266 mm
16-503-03	Ø 317 mm

16-503-04 203 x 206 mm

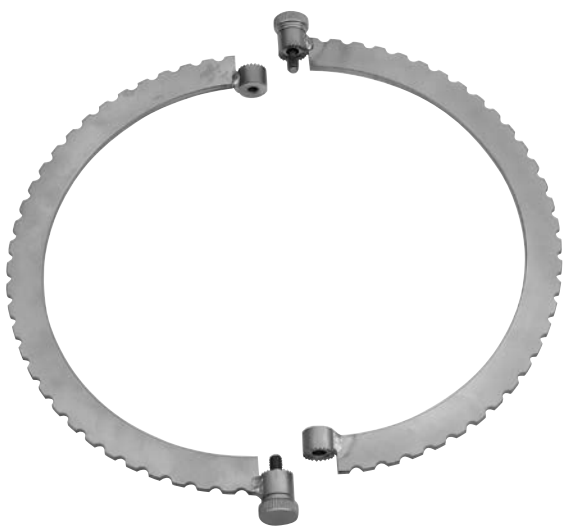

16-504-01 Ø 216 mm

16-505-01	216 x 356 mm
16-505-02	266 x 495 mm
16-505-03	317 x 495 mm



16-506-10	102 mm
16-506-15	152 mm
16-506-20	203 mm

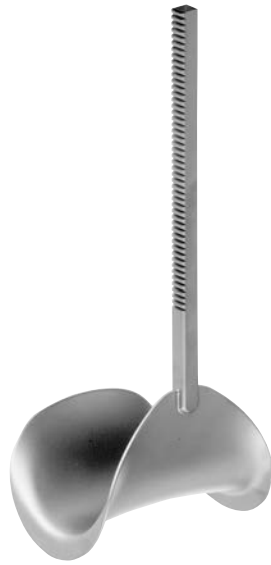

BALFOUR

16-510-01	67 x 76 mm
------------------	------------

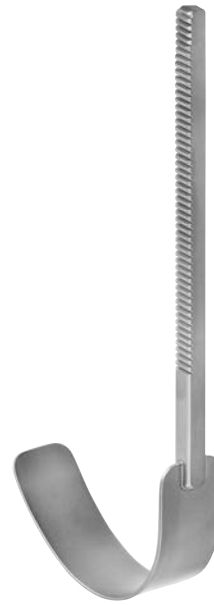

DEAVER

16-511-01	25 x 89 mm
16-511-02	25 x 127 mm



GELPI

16-512-01	
------------------	--



HARRINGTON

16-513-01	63 x 143 mm
------------------	-------------

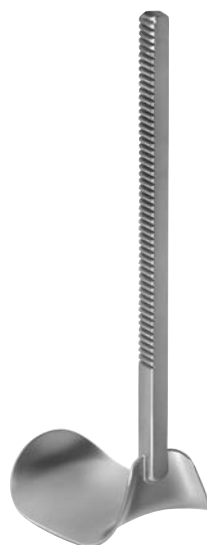

KELLY

16-514-01	25 x 38 mm
16-514-02	25 x 63 mm

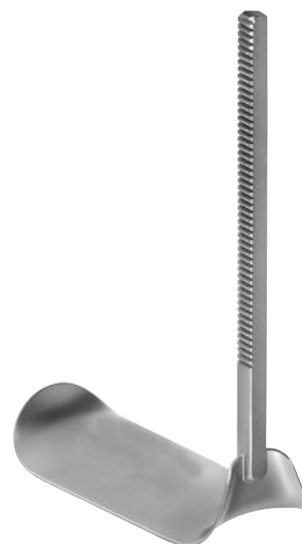

KELLY

16-515-01	51 x 51 mm
16-515-02	51 x 38 mm
16-515-03	51 x 65 mm
16-515-04	51 x 76 mm
16-515-05	51 x 101 mm
16-515-06	51 x 127 mm
16-515-07	51 x 152 mm



biegsam
malleable
maleable
malleabile

16-516-01	38 x 152 mm
16-516-02	51 x 152 mm
16-516-03	76 x 152 mm

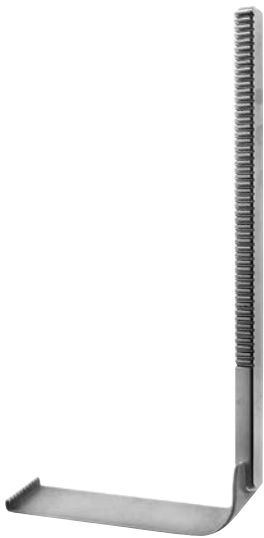

MEYERDING

16-517-01	60 x 17 mm
16-517-02	85 x 25 mm
16-517-03	95 x 50 mm



RAKE

16-518-01	19 x 17 mm
16-518-02	8,4 x 19 mm
16-518-03	8,4 x 25 mm

16-518-01

3 Zinker
3 teeth
3 dents
3 denti

16-518-02

4 Zinker
4 teeth
4 dents
4 denti

16-518-03

6 Zinker
6 teeth
6 dents
6 denti

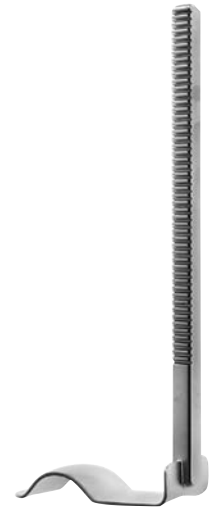

16-519-01	73 mm
16-519-02	98 mm



SCOVILLE

16-520-01	50 mm
16-520-02	83 mm

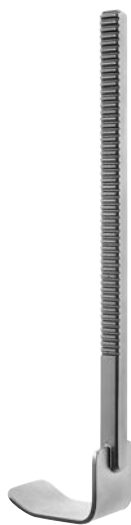

16-521-01	25 x 76 mm
------------------	------------



16-521-02	25 x 114 mm
------------------	-------------



17



Nadelhalter

Needle holders

Porta-agujas

Portaghi



17-000-15
17-000-18
17-000-20

HEGAR

17-000-15	15,0 cm, 6 "
17-000-18	17,5 cm, 7 "
17-000-20	20,0 cm, 8 "



17-001-16
17-001-18
17-001-20

HEGAR

17-001-16	16,0 cm, 6 ¼ "
17-001-18	17,5 cm, 7 "
17-001-20	20,0 cm, 8 "

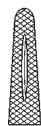

17-002-14

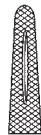

17-002-16



17-002-18

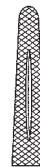

17-002-20



17-002-24



17-002-26



17-002-30

MAYO-HEGAR

17-002-14	14,0 cm, 5 ½ "
17-002-16	16,0 cm, 6 ¼ "
17-002-18	18,0 cm, 7 "
17-002-20	20,0 cm, 8 "
17-002-24	24,0 cm, 9 ½ "
17-002-26	26,0 cm, 10 ¼ "
17-002-30	30,0 cm, 11 ¾ "

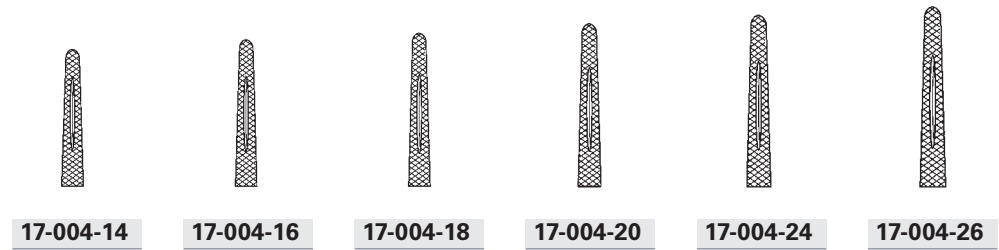

schlankes Modell
delicate pattern
modelo delgado
modello gracile

MAYO-HEGAR

17-004-14	14,0 cm, 5 1/2"
17-004-16	16,0 cm, 6 1/4"
17-004-18	18,0 cm, 7"
17-004-20	20,0 cm, 8"
17-004-24	24,0 cm, 9 1/2"
17-004-26	26,0 cm, 10 1/4"

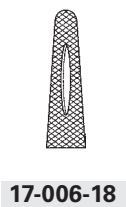

17-006-18

METZENBAUM

17-006-18 18,0 cm, 7"

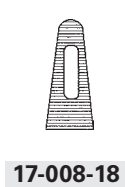
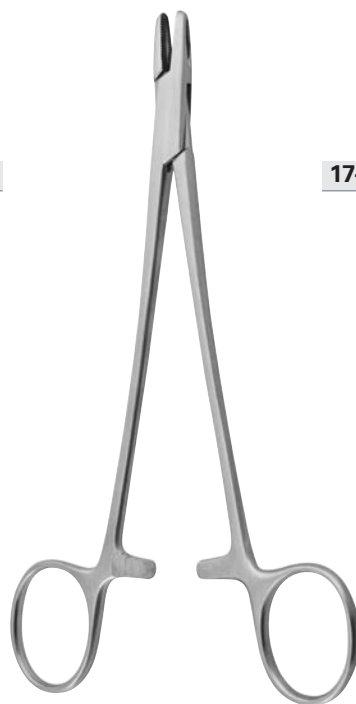

17-008-18

ADSON

17-008-18 18,0 cm, 7"



17-010-17

M.G. HOSPITAL

17-010-17 17,0 cm, 6 3/4"



CRILE-MURRAY

17-012-15 15,0 cm, 6"



17-012-15



CRILE-WOOD

17-014-15	15,0 cm, 6"
17-014-18	18,0 cm, 7"
17-014-20	20,0 cm, 8"
17-014-23	23,0 cm, 9"



17-014-15
17-014-18
17-014-20
17-014-23



BROWN

17-018-13	13,0 cm, 5 1/8"
17-018-18	18,0 cm, 7"



17-018-13
17-018-18

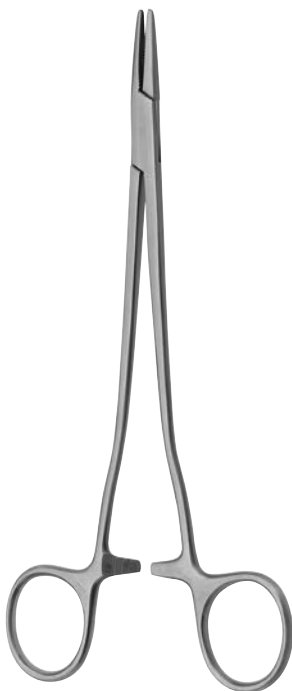

SAROT

17-020-18	18,0 cm, 7"
17-020-26	26,0 cm, 10 1/4"



17-020-18
17-020-26



HEGAR-BAUMGARTNER

17-022-12	12,0 cm, 5"
17-022-14	14,0 cm, 5 1/2"



17-022-12



17-022-14



17-024-13



17-026-13



17-030-13



NEIVERT

17-024-13 13,0 cm, 5 1/8"



HALSEY

17-026-13 - 17-030-13 13,0 cm, 5 1/8"



17-028-13



17-031-13



17-032-12



WEBSTER

17-028-13 13,0 cm, 5 1/8"

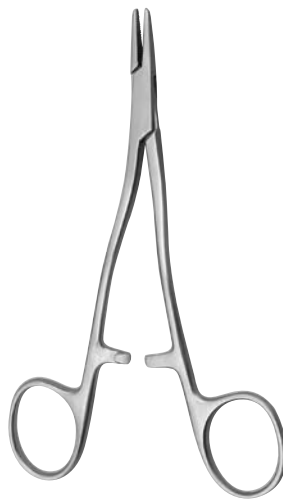

KILNER

17-031-13 13,0 cm, 5 1/8"



DERF (WRIGHT)

17-032-12 12,0 cm, 4 3/4"



17-034-12



DERF-CONVERSE

17-034-12 12,0 cm, 4 3/4"



17-035-12



DOYEN

17-035-12 12,5 cm, 5"



17-036-12



COLLIER

17-036-12 12,0 cm, 4 3/4"



17-037-21



HEANEY

17-037-21 21,0 cm, 8 1/4"



17-039-20
17-039-23



STRATTE

17-039-20 20,0 cm, 8"
17-039-23 23,0 cm, 9"



17-040-23



JAMESON

17-040-23 23,0 cm, 9"



17-041-20



17-041-24



17-041-26

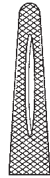
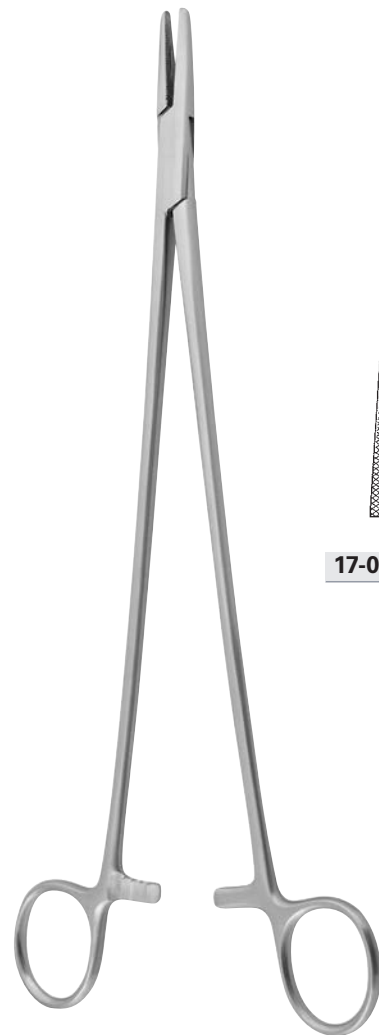

17-042-27

BOZEMANN-S

17-041-20	20,0 cm, 8 "
17-041-24	24,0 cm, 9 1/2 "
17-041-26	26,0 cm, 10 1/4 "

MASSON

17-042-27	27,0 cm, 10 3/4 "
-----------	-------------------

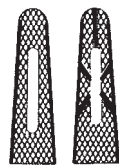
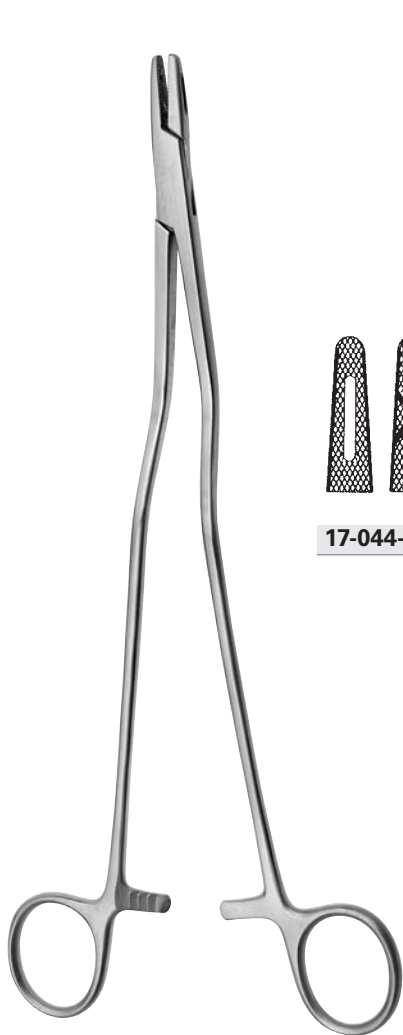

17-044-26

MASSON-LUETHY

17-044-26 26,0 cm, 10 1/4"

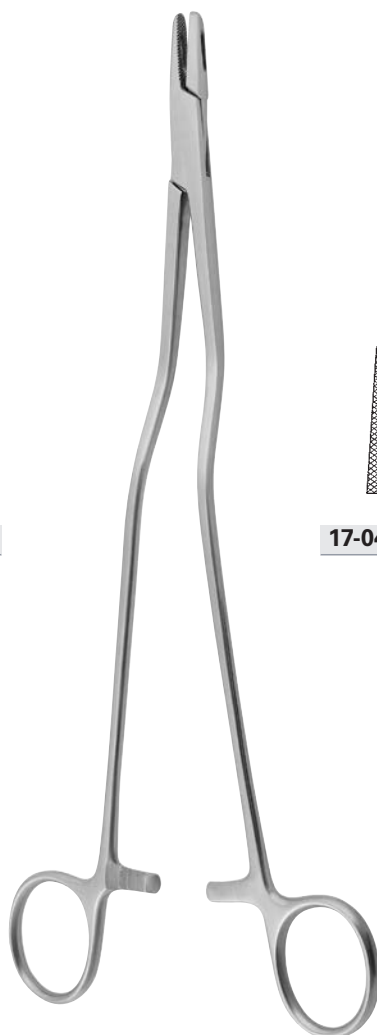

17-044-27

WANGENSTEEN

17-044-27 27,0 cm, 10 3/4"

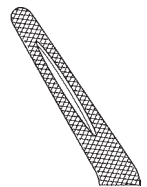

17-045-20
17-045-27

FINOCHIETTO

17-045-20 20,0 cm, 8"
17-045-27 27,0 cm, 10 3/4"



17-046-12



17-047-12



MINI-OLSEN

17-046-12 - 17-047-12 12,0 cm, 4 3/4 "

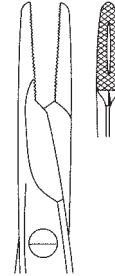

17-048-12

fein
delicate
delicato
fino



OLSEN-HEGAR

17-048-12 12,0 cm, 4 3/4 "

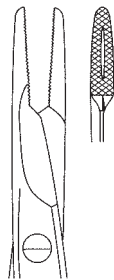

17-048-14



17-048-18



OLSEN-HEGAR

17-048-14 14,0 cm, 5 1/2 "
17-048-18 18,0 cm, 7 "

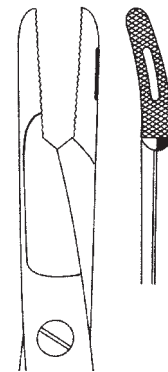

17-049-16



GILLIES

17-049-16 16,0 cm, 6 1/4 "



17-050-16



17-051-16



17-052-14



17-052-17



17-052-20

ARRUGA

17-050-16 - 17-051-16 16,0 cm, 6 1/4"

MATHIEU

17-052-14	14,0 cm, 5 1/2"
17-052-17	17,0 cm, 6 3/4"
17-052-20	20,0 cm, 8"



17-053-17



17-053-20



17-054-14



17-054-17

MATHIEU

17-053-17	17,0 cm, 6 3/4"
17-053-20	20,0 cm, 8"

MATHIEU

17-054-14	14,0 cm, 5 1/2"
17-054-17	17,0 cm, 6 3/4"



17-056-20

LICHTENBERG

17-056-20 20,0 cm, 8 "



17-057-18

EISELSBERG

17-057-18 18,5 cm, 7 ¼ "



17-061-15

CRILE

17-061-15 15,0 cm, 6 "



17-066-14

KALT

17-066-14 13,5 cm, 5 ¼ "

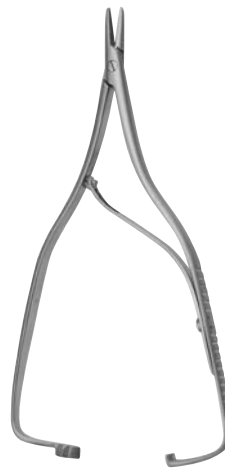

17-068-12

BOYNTON

17-068-12 12,5 cm, 5 "



17-070-18

TOENNIS

17-070-18 18,0 cm, 7 "





17-106-13 D
17-106-15 D
17-106-18 D
17-106-20 D
17-106-23 D



17-106-13 DT
17-106-15 DT
17-106-18 DT
17-106-20 DT
17-106-23 DT



VASCULAR

17-106-13 D	13,0 cm, 5"
17-106-15 D	15,0 cm, 6"
17-106-18 D	18,0 cm, 7"
17-106-20 D	20,0 cm, 8"
17-106-23 D	23,0 cm, 9"

VASCULAR

17-106-13 DT	13,0 cm, 5"
17-106-15 DT	15,0 cm, 6"
17-106-18 DT	18,0 cm, 7"
17-106-20 DT	20,0 cm, 8"
17-106-23 DT	23,0 cm, 9"



17-112-13 D
17-112-15 D
17-112-16 D
17-112-18 D
17-112-20 D
17-112-23 D



RYDER

17-112-13 D	13,0 cm, 5"
17-112-15 D	15,0 cm, 6"
17-112-16 D	15,0 cm, 6 1/4"
17-112-18 D	18,0 cm, 7"
17-112-20 D	20,0 cm, 8"
17-112-23 D	23,0 cm, 9"



17



Mikro Instrumente

Micro Instruments

Instrumentos de micro

Strumentario micro

Fordern Sie unser Spezialprospekt an
Please ask for our special catalogue
No duden pedirnos más catálogos especiales
Chiedete i nostri cataloghi speciali

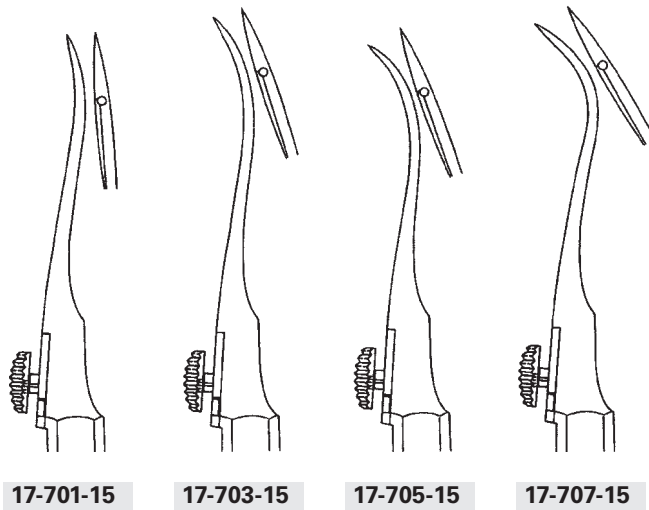

17-701-15

17-703-15

17-705-15

17-707-15

REVERDIN

17-701-15 - 17-707-15 15,0 cm, 6"

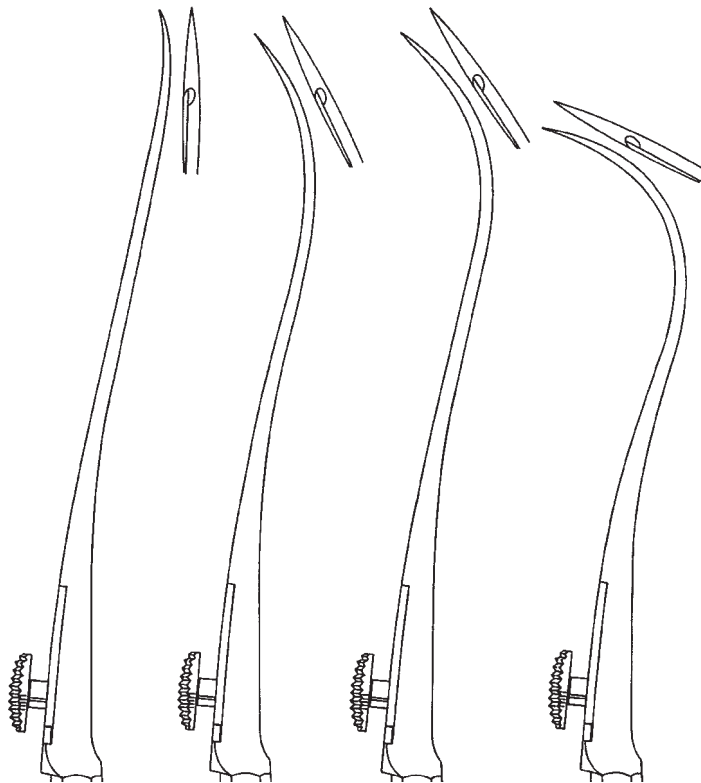

REVERDIN

17-701-19 - 17-707-19 19,0 cm, 7 1/2"
17-701-21 - 17-707-21 21,0 cm, 8 1/4"
17-701-23 - 17-707-23 23,0 cm, 9"

17-701-19
17-701-21
17-701-23

17-703-19
17-703-21
17-703-23

17-705-19
17-705-21
17-705-23

17-707-19
17-707-21
17-707-23



OBWEGESER

17-708-14 14,0 cm, 5 ½ "



OBWEGESER

17-708-23 23,0 cm, 9 "



OBWEGESER

17-709-18 18,0 cm, 7 "



17-711-32

biegsam
malleable
maleable
malleabile

SCHMIEDEN-DICK

17-711-32 30,0 cm, 11 ¾ "

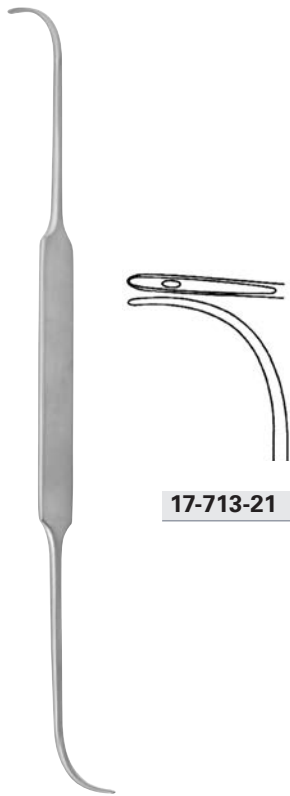

17-713-21

SCHMIEDEN

17-713-21 24,0 cm, 9 1/2"

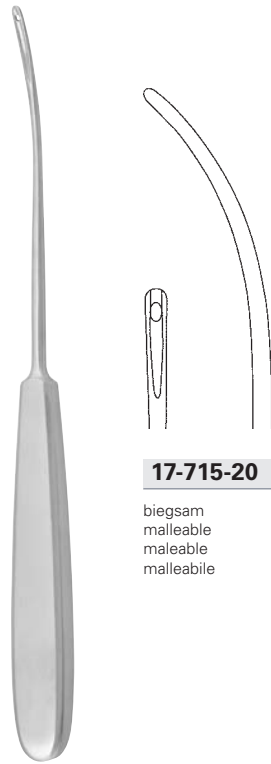

17-715-20

biegsam
malleable
maleable
malleabile

BRUNNER

17-715-24 24,0 cm, 9 1/2"

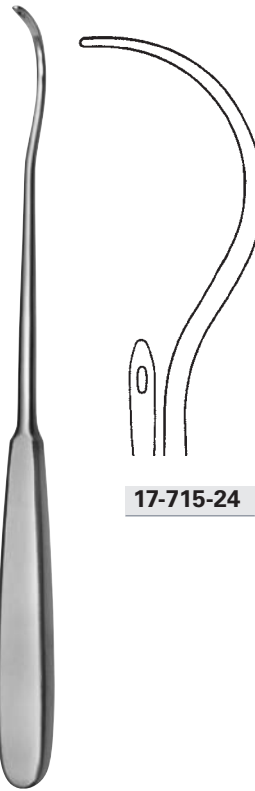

17-715-24

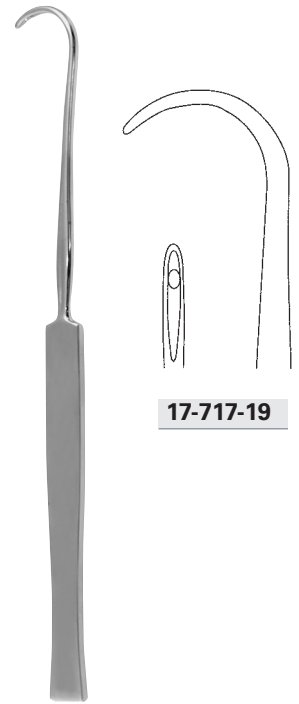

17-717-19

COOPER

17-717-19 19,0 cm, 7 1/2"

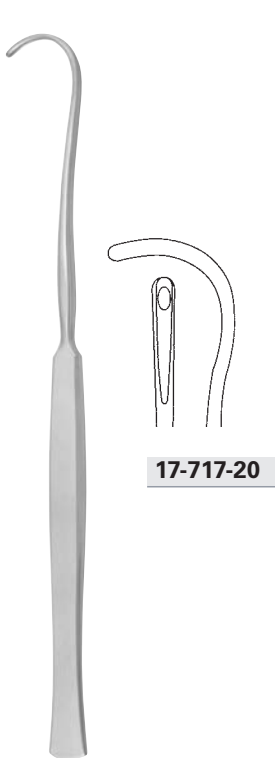

17-717-20

COOPER

17-717-20 20,0 cm, 8"

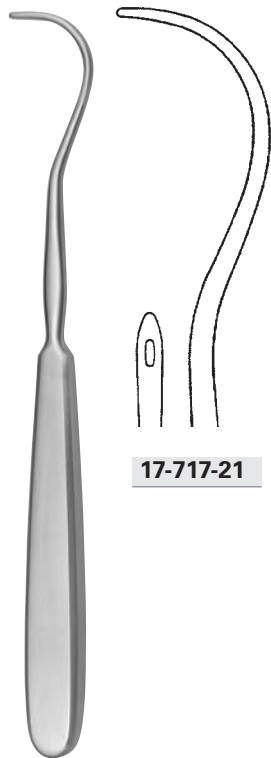

17-717-21

KOCHER

17-717-21 20,0 cm, 8"



17-721-13

für die rechte Hand
for right hand
para la mano derecha
per la mano destra

fein, stumpf
delicate, blunt
delicato, roma
fino, smusso

KRONECKER

17-721-13 13,0 cm, 5 1/8"



17-723-13

für die linke Hand
for left hand
para la mano izquierda
per la mano sinistra

fein, stumpf
delicate, blunt
delicato, roma
fino, smusso

KRONECKER

17-723-13 13,0 cm, 5 1/8"



17-725-20

für die rechte Hand
for right hand
para la mano derecha
per la mano destra

scharf
sharp
aguda
acuto



17-726-20

für die linke Hand
for left hand
para la mano izquierda
per la mano sinistra

scharf
sharp
aguda
acuto



17-727-20

für die rechte Hand
for right hand
para la mano derecha
per la mano destra

stumpf
blunt
roma
smusso



17-728-20

für die linke Hand
for left hand
para la mano izquierda
per la mano sinistra

stumpf
blunt
roma
smusso



DESCHAMPS

17-725-20 20,0 cm, 8 "

DESCHAMPS

17-726-20 20,0 cm, 8 "

DESCHAMPS

17-727-20 20,0 cm, 8 "

DESCHAMPS

17-728-20 20,0 cm, 8 "



17-729-20

für die rechte Hand
for right hand
para la mano derecha
per la mano destra

stumpf
blunt
roma
smusso



17-730-20

für die linke Hand
for left hand
para la mano izquierda
per la mano sinistra

stumpf
blunt
roma
smusso



17-731-20

für die rechte Hand
for right hand
para la mano derecha
per la mano destra

stumpf
blunt
roma
smusso



17-733-20

für die linke Hand
for left hand
para la mano izquierda
per la mano sinistra

stumpf
blunt
roma
smusso



DESCHAMPS

17-729-20 20,0 cm, 8 "

DESCHAMPS

17-730-20 20,0 cm, 8 "

DESCHAMPS

17-731-20 20,0 cm, 8 "

DESCHAMPS

17-733-20 20,0 cm, 8 "

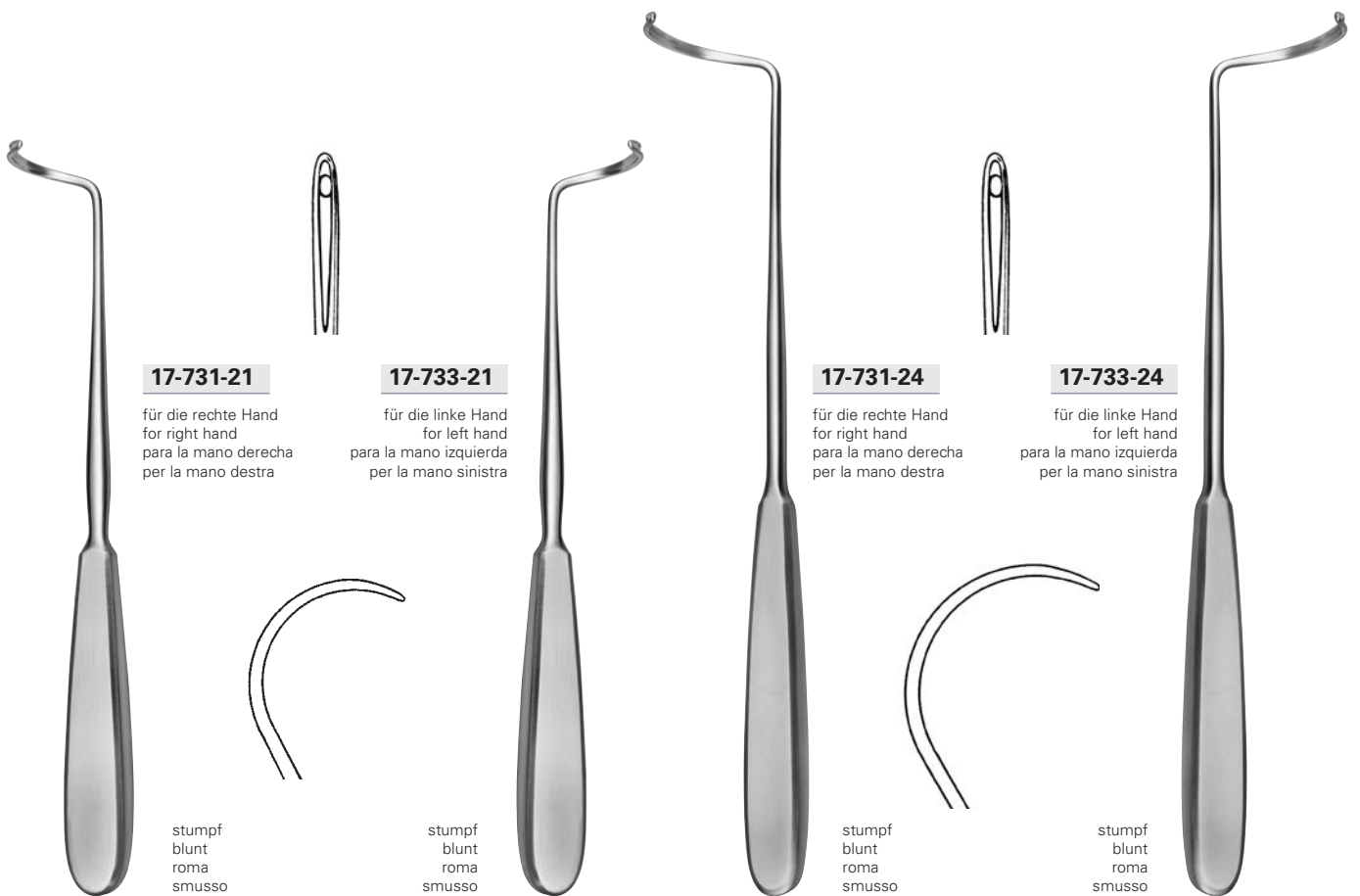

17-731-21

für die rechte Hand
for right hand
para la mano derecha
per la mano destra

stumpf
blunt
roma
smusso

17-733-21

für die linke Hand
for left hand
para la mano izquierda
per la mano sinistra

stumpf
blunt
roma
smusso

17-731-24

für die rechte Hand
for right hand
para la mano derecha
per la mano destra

stumpf
blunt
roma
smusso

17-733-24

für die linke Hand
for left hand
para la mano izquierda
per la mano sinistra

stumpf
blunt
roma
smusso

DESCHAMPS

17-731-21 21,0 cm, 8 ¼ "

DESCHAMPS

17-733-21 21,0 cm, 8 ¼ "

DESCHAMPS

17-731-24 24,0 cm, 9 ½ "

DESCHAMPS

17-733-24 24,0 cm, 9 ½ "

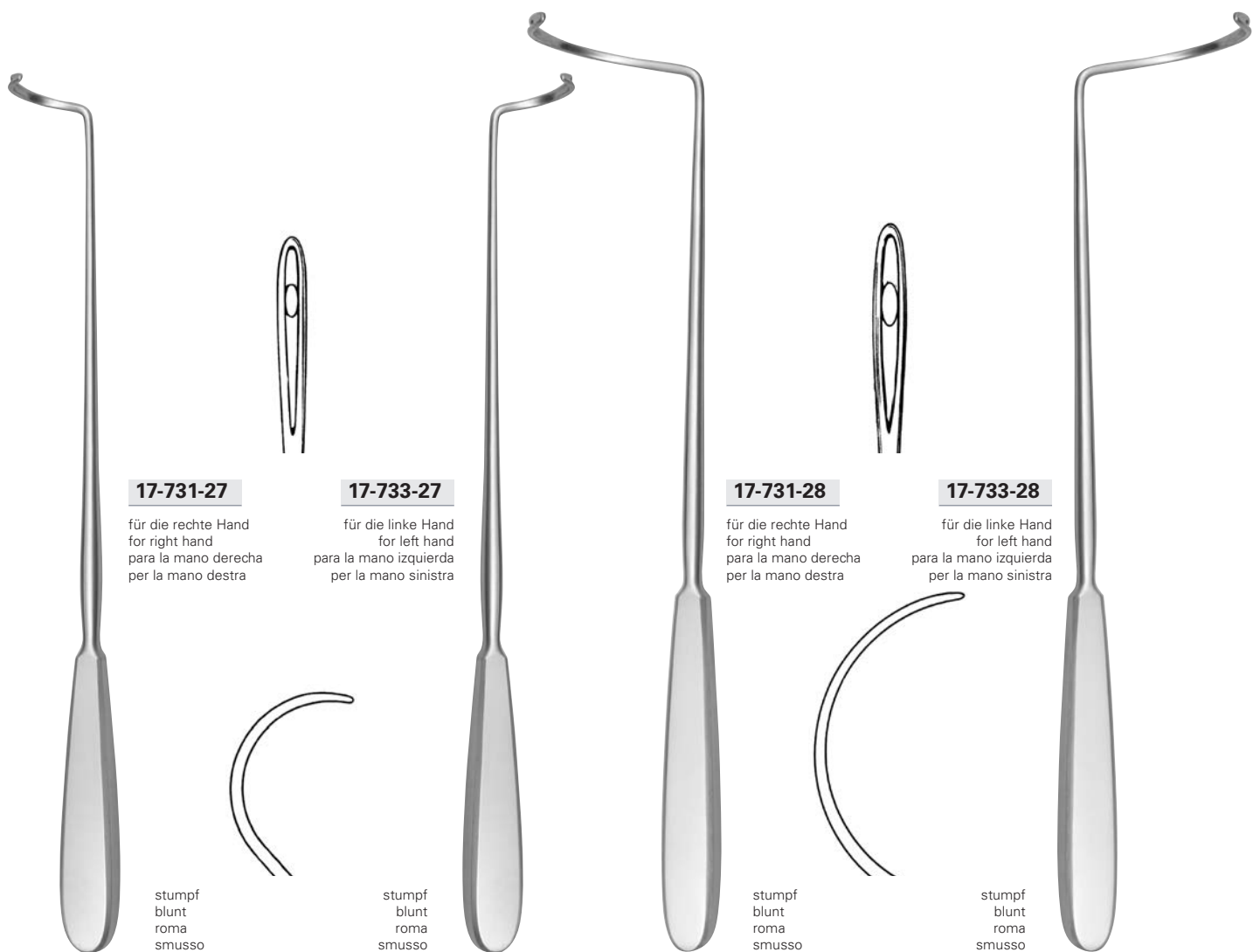

17-731-27

für die rechte Hand
for right hand
para la mano derecha
per la mano destra

stumpf
blunt
roma
smusso

17-733-27

für die linke Hand
for left hand
para la mano izquierda
per la mano sinistra

stumpf
blunt
roma
smusso

17-731-28

für die rechte Hand
for right hand
para la mano derecha
per la mano destra

stumpf
blunt
roma
smusso

17-733-28

für die linke Hand
for left hand
para la mano izquierda
per la mano sinistra

stumpf
blunt
roma
smusso

DESCHAMPS

17-731-27 27,0 cm, 10³/₄"

DESCHAMPS

17-733-27 27,0 cm, 10³/₄"

DESCHAMPS

17-731-28 28,0 cm, 11"

DESCHAMPS

17-733-28 28,0 cm, 11"



17-735-19

für die rechte Hand
for right hand
para la mano derecha
per la mano destra

scharf
sharp
aguda
acuto



17-737-19

für die linke Hand
for left hand
para la mano izquierda
per la mano sinistra

scharf
sharp
aguda
acuto



17-735-20

für die rechte Hand
for right hand
para la mano derecha
per la mano destra

scharf
sharp
aguda
acuto



17-737-20

für die linke Hand
for left hand
para la mano izquierda
per la mano sinistra

scharf
sharp
aguda
acuto



DESCHAMPS

17-735-19 20,0 cm, 8"

DESCHAMPS

17-737-19 20,0 cm, 8"

DESCHAMPS

17-735-20 20,0 cm, 8"

DESCHAMPS

17-737-20 20,0 cm, 8"



17-735-21

für die rechte Hand
for right hand
para la mano derecha
per la mano destra

scharf
sharp
aguda
acuto



17-737-21

für die linke Hand
for left hand
para la mano izquierda
per la mano sinistra

scharf
sharp
aguda
acuto



17-735-24

für die rechte Hand
for right hand
para la mano derecha
per la mano destra

scharf
sharp
aguda
acuto



17-737-24

für die linke Hand
for left hand
para la mano izquierda
per la mano sinistra

scharf
sharp
aguda
acuto



DESCHAMPS

17-735-21 21,0 cm, 8 1/4"

DESCHAMPS

17-737-21 21,0 cm, 8 1/4"

DESCHAMPS

17-735-24 24,0 cm, 9 1/2"

DESCHAMPS

17-737-24 24,0 cm, 9 1/2"

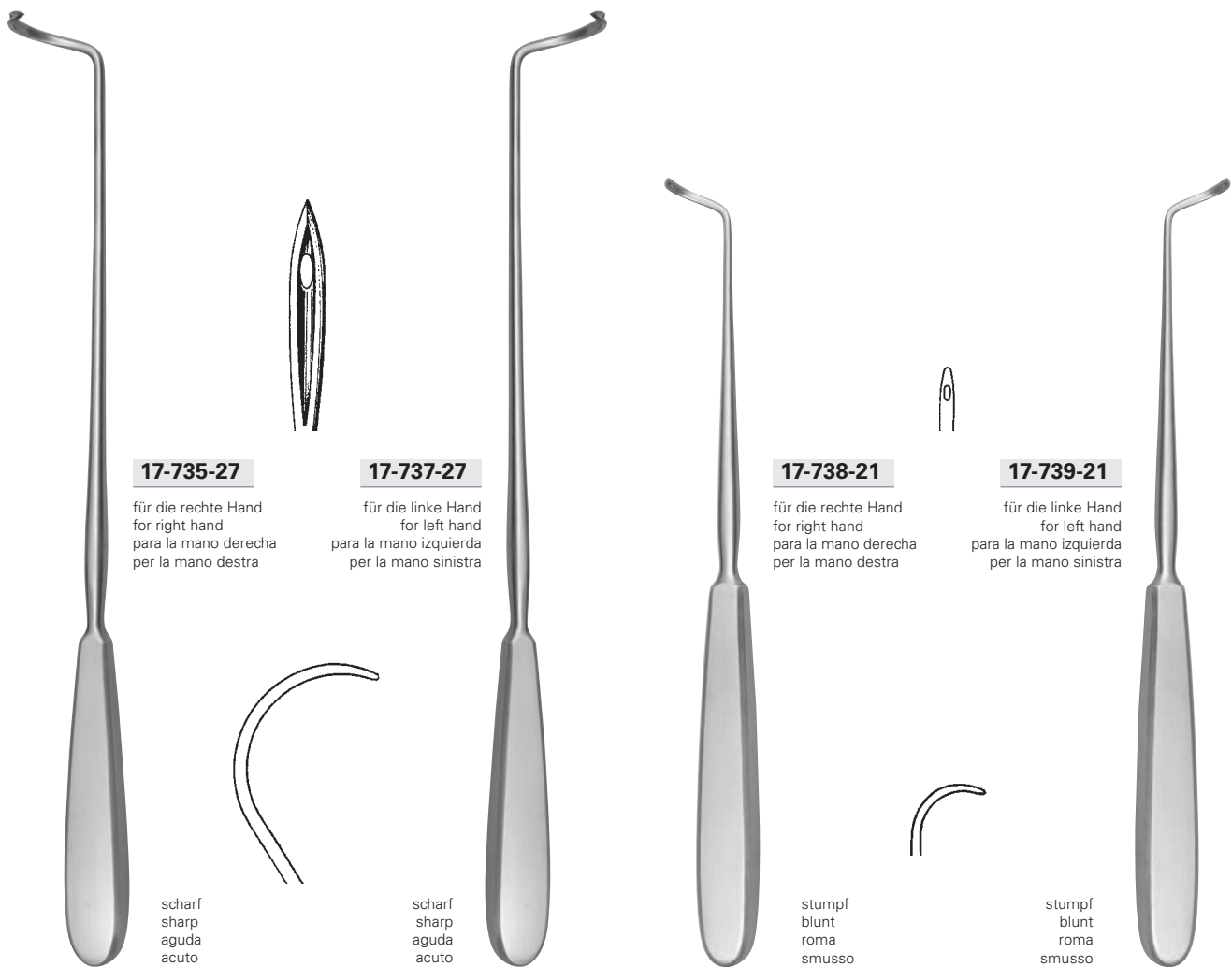

17-735-27

für die rechte Hand
for right hand
para la mano derecha
per la mano destra

scharf
sharp
aguda
acuto

17-737-27

für die linke Hand
for left hand
para la mano izquierda
per la mano sinistra

scharf
sharp
aguda
acuto

17-738-21

für die rechte Hand
for right hand
para la mano derecha
per la mano destra

stumpf
blunt
roma
smusso

17-739-21

für die linke Hand
for left hand
para la mano izquierda
per la mano sinistra

stumpf
blunt
roma
smusso

DESCHAMPS

17-735-27 27,0 cm, 10³/₄"

DESCHAMPS

17-737-27 27,0 cm, 10³/₄"

DESCHAMPS

17-738-21 22,5 cm, 9"

DESCHAMPS

17-739-21 22,5 cm, 9"



17-738-22

für die rechte Hand
for right hand
para la mano derecha
per la mano destra

stumpf
blunt
roma
smusso



17-739-22

für die linke Hand
for left hand
para la mano izquierda
per la mano sinistra

stumpf
blunt
roma
smusso



17-738-23

für die rechte Hand
for right hand
para la mano derecha
per la mano destra

stumpf
blunt
roma
smusso



17-739-23

für die linke Hand
for left hand
para la mano izquierda
per la mano sinistra

stumpf
blunt
roma
smusso

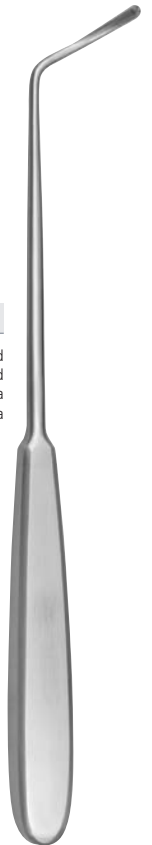
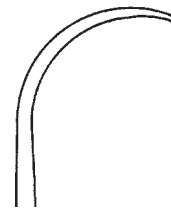

DESCHAMPS

17-738-22 22,5 cm, 9"

DESCHAMPS

17-739-22 22,5 cm, 9"

DESCHAMPS

17-738-23 23,0 cm, 9"

DESCHAMPS

17-739-23 23,0 cm, 9"

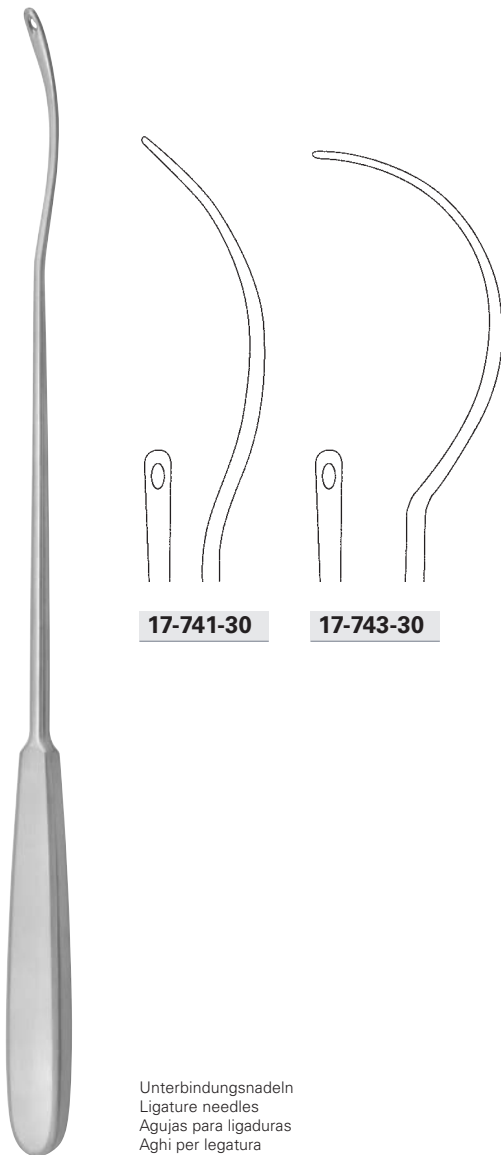

17-741-30

17-743-30

Unterbindungsnadeln
Ligature needles
Agujas para ligaduras
Aghi per legatura

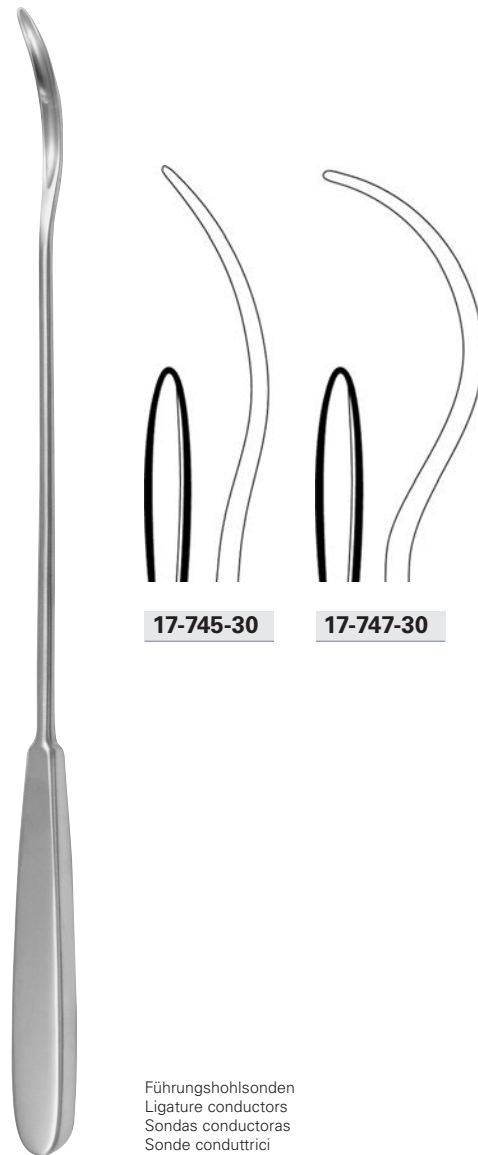

17-745-30

17-747-30

Führungshohlsonden
Ligature conductors
Sondas conductoras
Sonde conduttrici

BRUNNER

17-741-30 - 17-743-30 30,0 cm, 11 3/4"

BRUNNER

17-745-30 - 17-747-30 30,0 cm, 11 3/4"



17-749-28

17-749-28 28,0 cm, 11 "



JONESCO

17-751-18 18,5 cm, 7 "

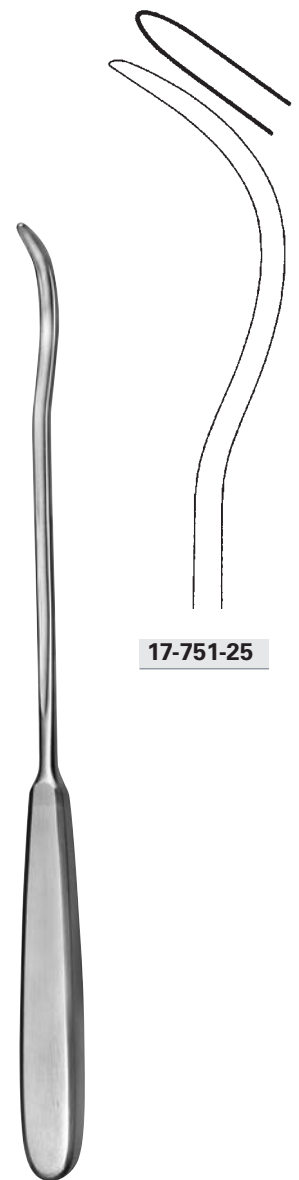

17-751-25

KIRSCHNER

17-751-25 25,5 cm, 10 "

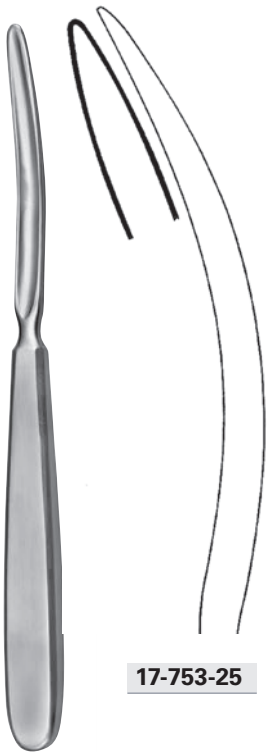

17-753-25

17-753-25 19,5 cm, 7 3/4"



BRUNNER

17-755-18 18,0 cm, 7"
17-755-27 27,0 cm, 10 3/4"



KIRSCHNER

17-757-27 27,0 cm, 10 3/4"



17-758-19

gerade
straight
recta
retta

17-759-19

gebogen
curved
curva
curva



17-758-19 - 17-759-19 19,0 cm, 7 1/2"

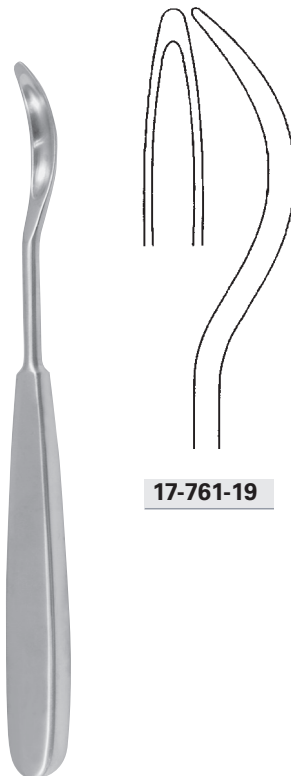

17-761-19

SCHMIEDEN

17-761-19 19,0 cm, 7 1/2"

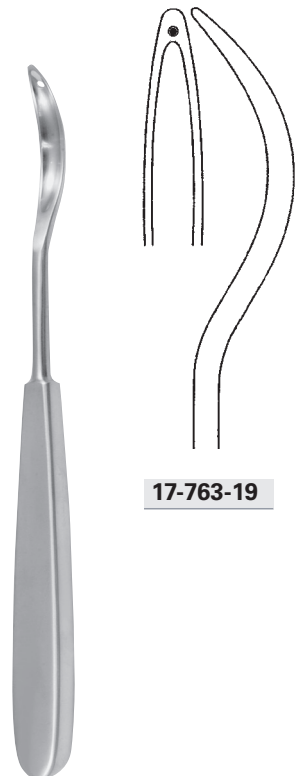

17-763-19

SCHMIEDEN-PAYR

17-763-19 19,0 cm, 7 1/2"

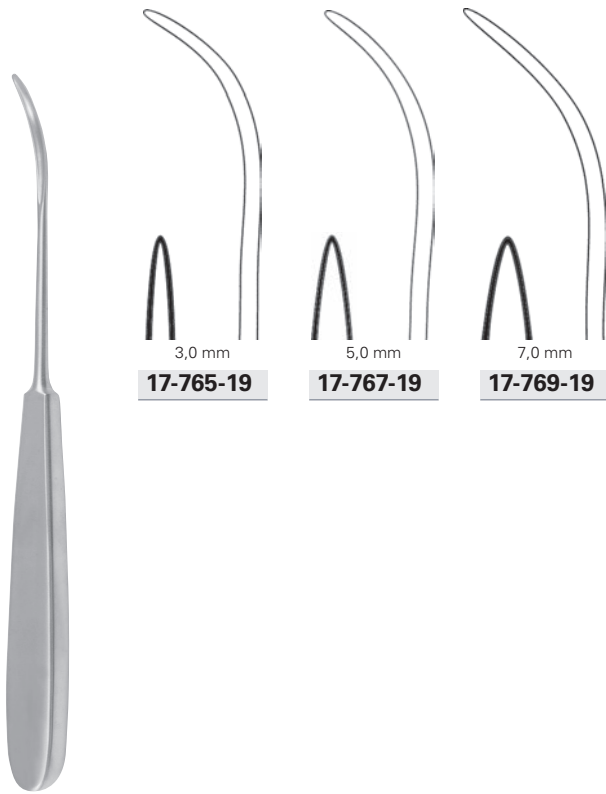

KOENIG

17-765-19 - 17-769-19 19,0 cm, 7 1/2"

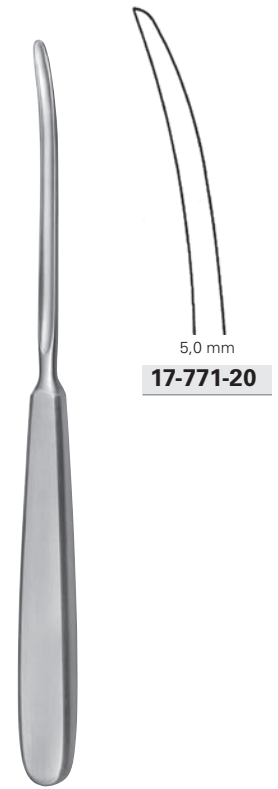

PAYR

17-771-20 20,0 cm, 8"

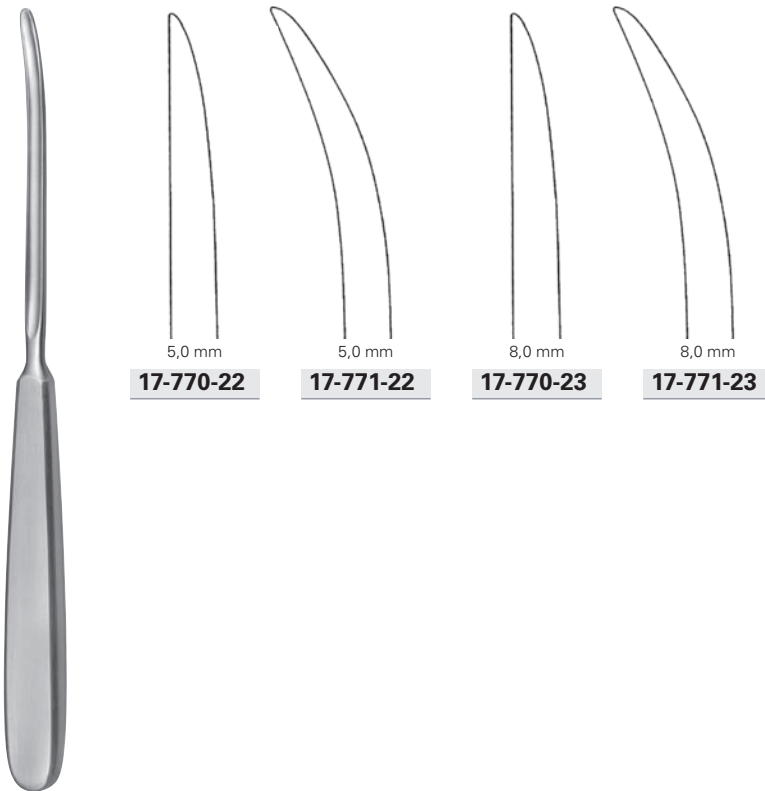

PAYR

17-770-22 - 17-771-23 22,0 cm, 8 3/4"



17-772-24 24,0 cm, 9 1/2"



17-773-18 18,5 cm, 7 ¼ "



Fadengabel
 Ligature adjuster
 Horquilla de hilos
 Forchetta da sutura

17-786-23 23,0 cm, 9 "



Fadenfänger
 Ligature catcher
 Captador de hilos
 Portalegature

MOD. VIENNA (WIEN)

17-787-24 23,5 cm, 9 ¼ "



Fig. 1

17-790-51



Fig. 2

17-790-52



Fig. 3

17-790-53

komplett mit einem Nadelaufsatz Fig. 1 | 17-790-51
 complete with one needle Fig.1 | 17-790-51
 completo con una aguja Fig.1 | 17-790-51
 completo con un ago Fig.1 | 17-790-51

YOUNG-HRYNTSCHAK

17-790-24 24,0 cm, 9 ½ "

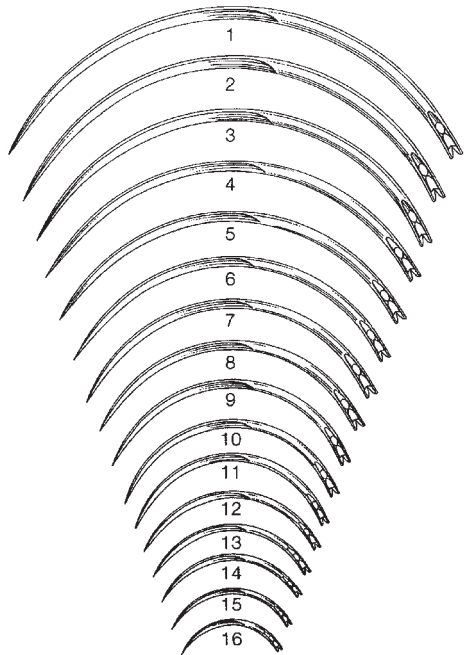
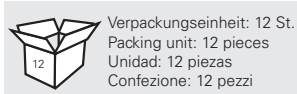

gebogen $\frac{3}{8}$ Kreis
curved $\frac{3}{8}$ circle
curvas $\frac{3}{8}$ círculo
curvi $\frac{3}{8}$ circolo



B

17-803-01	Fig. 1
17-803-02	Fig. 2
17-803-03	Fig. 3
17-803-04	Fig. 4
17-803-05	Fig. 5
17-803-06	Fig. 6
17-803-07	Fig. 7
17-803-08	Fig. 8
17-803-09	Fig. 9
17-803-10	Fig. 10
17-803-11	Fig. 11
17-803-12	Fig. 12
17-803-13	Fig. 13
17-803-14	Fig. 14
17-803-15	Fig. 15
17-803-16	Fig. 16

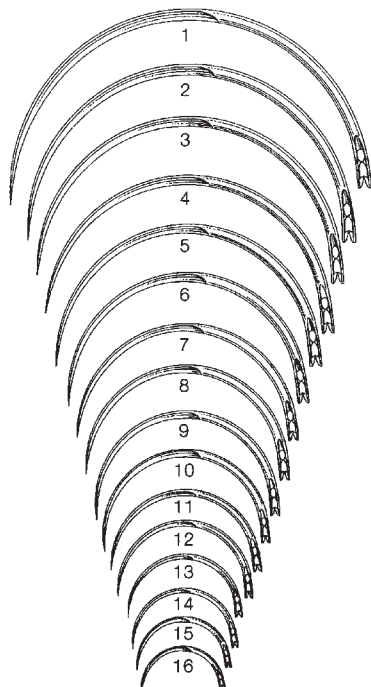
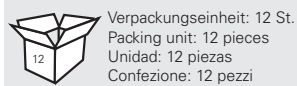

gebogen $\frac{1}{2}$ Kreis
curved $\frac{1}{2}$ circle
curvas $\frac{1}{2}$ círculo
curvi $\frac{1}{2}$ circolo



G

17-817-01	Fig. 1
17-817-02	Fig. 2
17-817-03	Fig. 3
17-817-04	Fig. 4
17-817-05	Fig. 5
17-817-06	Fig. 6
17-817-07	Fig. 7
17-817-08	Fig. 8
17-817-09	Fig. 9
17-817-10	Fig. 10
17-817-11	Fig. 11
17-817-12	Fig. 12
17-817-13	Fig. 13
17-817-14	Fig. 14
17-817-15	Fig. 15
17-817-16	Fig. 16

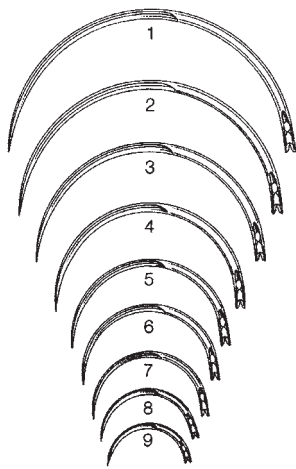
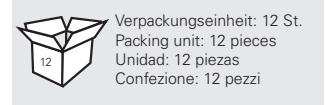
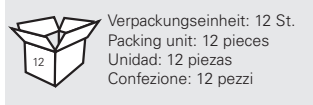

gebogen 1/2 Kreis
curved 1/2 circle
curvas 1/2 círculo
curvi 1/2 circolo

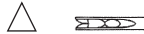

Ga

17-819-01	Fig. 1
17-819-02	Fig. 2
17-819-03	Fig. 3
17-819-04	Fig. 4
17-819-05	Fig. 5
17-819-06	Fig. 6
17-819-07	Fig. 7
17-819-08	Fig. 8
17-819-09	Fig. 9

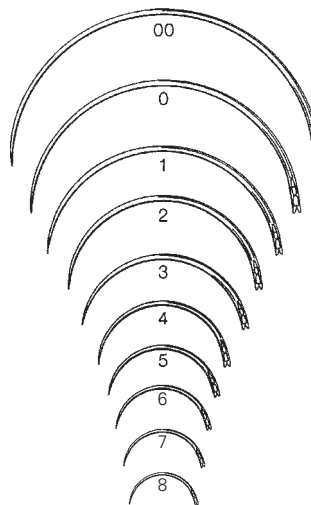

gebogen 1/2 Kreis
curved 1/2 circle
curvas 1/2 círculo
curvi 1/2 circolo



Pb

17-851-02	Fig. 00
17-851-03	Fig. 0
17-853-01	Fig. 1
17-853-02	Fig. 2
17-853-03	Fig. 3
17-853-04	Fig. 4
17-853-05	Fig. 5
17-853-06	Fig. 6
17-853-07	Fig. 7
17-853-08	Fig. 8

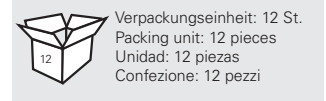
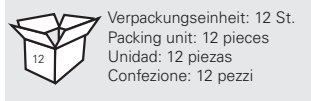

gebogen 3/8 Kreis
curved 3/8 circle
curvas 3/8 círculo
curvi 3/8 circolo



Pd

17-855-02	Fig. 00
17-855-03	Fig. 0
17-857-01	Fig. 1
17-857-02	Fig. 2
17-857-03	Fig. 3
17-857-04	Fig. 4
17-857-05	Fig. 5

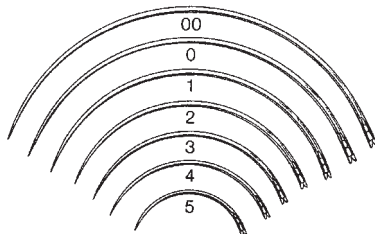

gebogen 3/8 Kreis
curved 3/8 circle
curvas 3/8 círculo
curvi 3/8 circolo



KALT

17-871-02	Fig. 00
17-871-03	Fig. 0
17-873-01	Fig. 1
17-873-02	Fig. 2
17-873-03	Fig. 3

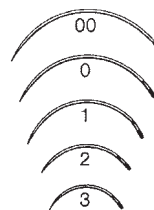



Verpackungseinheit: 12 St.
Packing unit: 12 pieces
Unidad: 12 piezas
Confezione: 12 pezzi



Verpackungseinheit: 12 St.
Packing unit: 12 pieces
Unidad: 12 piezas
Confezione: 12 pezzi

gebogen 1/2 Kreis
curved 1/2 circle
curvas 1/2 círculo
curvi 1/2 circolo



gebogen 1/2 Kreis
curved 1/2 circle
curvas 1/2 círculo
curvi 1/2 circolo

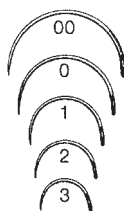

PAYR

17-877-02	Fig. 00
17-877-03	Fig. 0
17-879-01	Fig. 1
17-879-02	Fig. 2
17-879-03	Fig. 3

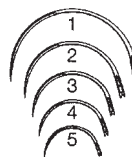

Og

17-881-01	Fig. 1
17-881-02	Fig. 2
17-881-03	Fig. 3
17-881-04	Fig. 4
17-881-05	Fig. 5



Verpackungseinheit: 12 St.
Packing unit: 12 pieces
Unidad: 12 piezas
Confezione: 12 pezzi



Verpackungseinheit: 1000 St.
Packing unit: 1000 pieces
Unidad: 1000 piezas
Confezione: 1000 pezzi



gebogen 3/8 Kreis
curved 3/8 circle
curvas 3/8 círculo
curvi 3/8 circolo



Wundklammern
Suture Clips
Agrafes de sutura
Agrafe da sutura

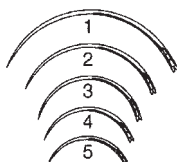

Ob

17-883-01	Fig. 1
17-883-02	Fig. 2
17-883-03	Fig. 3
17-883-04	Fig. 4
17-883-05	Fig. 5

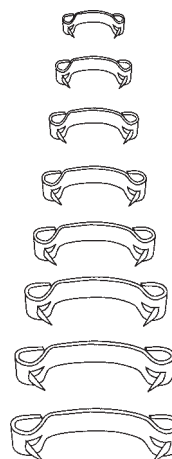

MICHEL

17-902-07	7,5 x 1,75 mm
17-902-11	11,0 x 2,0 mm
17-902-12	12,0 x 3,0 mm
17-902-14	14,0 x 3,0 mm
17-902-16	16,0 x 3,0 mm
17-902-18	18,0 x 3,0 mm
17-902-20	20,0 x 3,0 mm
17-902-22	22,0 x 3,0 mm

Klammeranlege- und Entfernungszange
 Clip applying and removing forceps
 Pinza para poner y quitar agrafes
 Pinze per mettere e togliere clips



MICHEL

17-907-12 12,5 cm, 5 "



MICHEL

17-909-13 13,0 cm, 5 1/8 "



MICHEL

17-910-12 12,0 cm, 4 3/4 "



WACHENFELDT

17-911-12 12,5 cm, 5 "



WACHENFELDT

17-912-12 12,5 cm, 5 "



HEGENBARTH

17-916-12 12,0 cm, 4 3/4 "

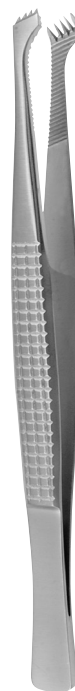

CHILDE

17-918-01 18,0 cm, 7 "



CHILDE

17-918-02 18,0 cm, 7 "

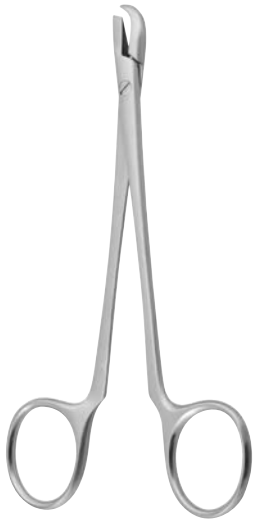

COLLIN

17-932-13 13,5 cm, 5 ¼"



RICHTER-HEATH

17-933-14 13,5 cm, 5 ¼"



SMALL

17-950-15 14,5 cm, 5 ¾"
17-950-18 18,5 cm, 7 ¼"
17-950-28 27,5 cm, 10 ¾"



MEDIUM

17-952-14 14,5 cm, 5 ¾"
17-952-18 18,5 cm, 7 ¼"
17-952-28 27,5 cm, 10 ¾"



MEDIUM-LARGE

17-953-19 18,5 cm, 7 ¼"
17-953-28 27,5 cm, 10 ¾"



LARGE

17-954-18 18,5 cm, 7 ¼"
17-954-28 27,5 cm, 10 ¾"

Klammeranlegezangen ETHICON
Clip applying forceps ETHICON
Pinzas para poner agrafes ETHICON
Pinze per mettere clips ETHICON



18



Nadelhalter mit
Hartmetalleinlagen

Needle Holders with
tungsten carbide inserts

Porta-agujas con bocas
de carburo tungsteno

Portaghi con morsi in
carburo di tungsteno

Kennzeichnung: goldene Ringe
Characteristic: golden rings
Característica: mangos dorados
Caratteristica: anelli dorata

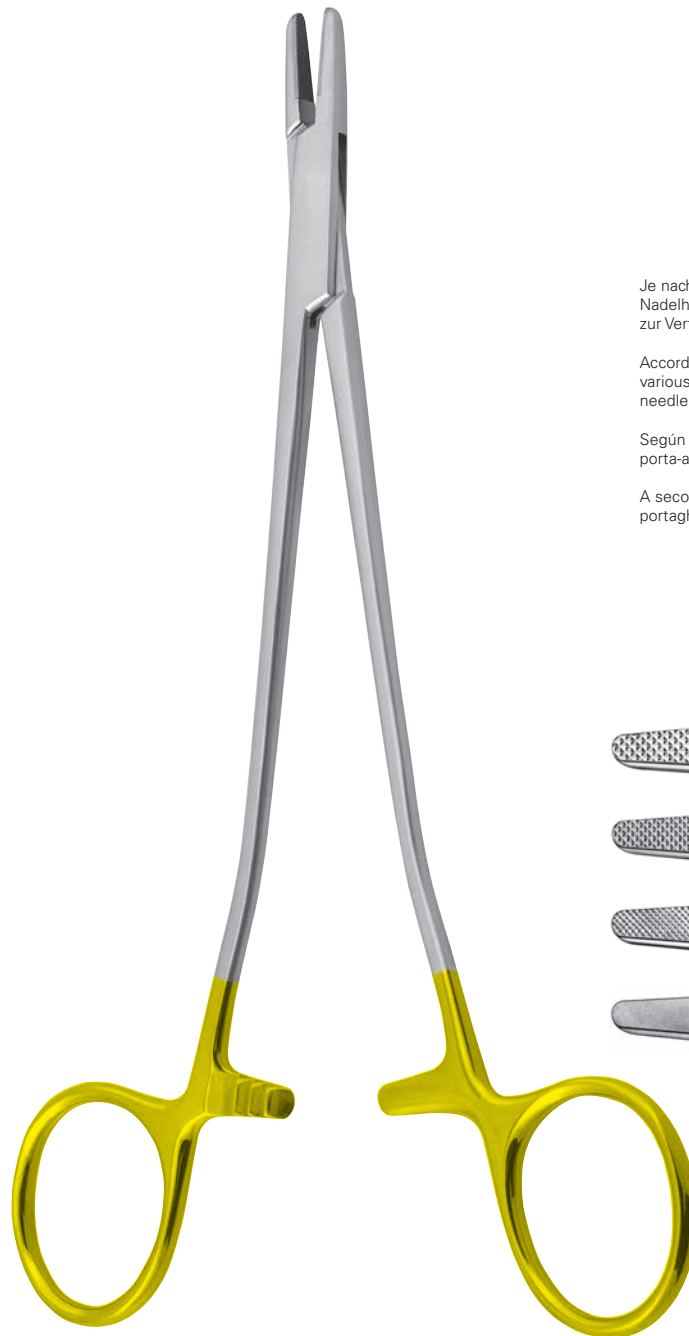

Je nach Anwendungsgebiet stehen für TC Nadelhalter unterschiedliche Hartmetalleinlagen zur Verfügung:

According to the field of application, there are various types of tungsten carbide inserts for TC needle holders:

Según campo de aplicación, disponemos de TC porta-agujas con varias capas intermedias:

A seconda delle necessità disponiamo di TC portaghi con varie capacità intermedie:

für Nahtmaterial
for suture material
para suturas
per materiale di suture

Riefung
Serration
Estradadura
Struttura



0,5 mm



0,4 mm



0,3 mm



glatt
smooth
liso
liscie

- Hartmetalleinlagen mit präzise gearbeitetem Pyramidenprofil garantieren einen sicheren Halt der Nadel.
- Gebrochene Kanten verhindern ein Verfangen des Nahtmaterials.
- Die leichtgängige Sperre ermöglicht eine sichere Arbeitsweise.
- Tungsten carbide inserts with precisely worked out structure guarantee a secure grip of the needle.
- Bevelled edges to prevent catching of suture material.
- Soft working catch provides safe handling.
- Capas intermedias de carburo tungsteno con perfil amoldado piramidal que garantiza un sujeto seguro de la aguja.
- Bordes quebrados evitan que se enredare el material de sutura.
- El cierre suave facilita un manejo seguro.
- Inserti in carburo di tungsteno che garantiscono una perfettatenuta dell'ago.
- I bordi squadrati evitano che si impigliano i fili di sutura.
- Il bloccaggio leggero e preciso facilita un uso sicuro.



A
0,6 - 4,0



18-000-18



18-000-20



18-000-24

HEGAR

18-000-18	18,0 cm, 7 "
18-000-20	20,0 cm, 8 "
18-000-24	24,0 cm, 9 ½ "

A
0,6 - 4,0



18-002-14



18-002-16



18-002-18



18-002-20



18-002-24



18-002-26



18-002-30



18-002-36



18-002-40

MAYO-HEGAR

18-002-14	14,0 cm, 5 ½ "
18-002-16	16,0 cm, 6 ¼ "
18-002-18	18,0 cm, 7 "
18-002-20	20,0 cm, 8 "
18-002-24	24,0 cm, 9 ½ "
18-002-26	26,0 cm, 10 ¼ "
18-002-30	30,0 cm, 11 ¾ "
18-002-36	36,0 cm, 14 "
18-002-40	40,0 cm, 16 "



18-004-15



18-004-16



18-004-18



18-004-20



18-004-23



18-004-26



18-004-31



18-004-37

DE BAKEY

18-004-15	15,0 cm, 6 "
18-004-16	16,0 cm, 6 ¼ "
18-004-18	18,0 cm, 7 "
18-004-20	20,0 cm, 8 "
18-004-23	23,0 cm, 9 "
18-004-26	26,0 cm, 10 ¼ "
18-004-31	31,0 cm, 12 ½ "
18-004-37	37,0 cm, 14 ½ "



18-012-15



18-012-18



18-012-20



18-012-23



18-012-36



18-012-40



CRILE-WOOD

18-012-15	15,0 cm, 6 "
18-012-18	18,0 cm, 7 "
18-012-20	20,0 cm, 8 "
18-012-23	23,0 cm, 9 "
18-012-36	36,0 cm, 14 "
18-012-40	40,0 cm, 16 "



18-005-20

18-005-25



18-014-15



DE BAKEY

18-005-20	20,0 cm, 8 "
18-005-25	25,0 cm, 9 3/4 "

BABY-CRILE-WOOD

18-014-15	15,0 cm, 6 "
-----------	--------------



18-016-15

18-016-17

18-016-20



18-018-15



SENNING

18-016-15	15,0 cm, 6 "
18-016-17	17,0 cm, 6 3/4 "
18-016-20	20,0 cm, 8 "

CRILE-WOOD

18-018-15	15,0 cm, 6 "
-----------	--------------



18-020-18



18-020-20



18-020-26



18-022-13
18-022-14

B
4,0 - 6,0



SAROT

18-020-18	18,0 cm, 7"
18-020-20	20,0 cm, 8"
18-020-26	26,0 cm, 10 1/4"

HEGAR-BAUMGARTNER

18-022-13	13,0 cm, 5 1/8"
18-022-14	14,0 cm, 5 1/2"



18-024-13



18-026-13



18-028-13



NEIVERT-MASING

18-024-13	13,0 cm, 5 1/8"
-----------	-----------------

HALSEY

18-026-13 - 18-028-13	13,0 cm, 5 1/8"
-----------------------	-----------------



18-030-13



WEBSTER

18-030-13 13,0 cm, 5 1/8"



18-031-13



KILNER

18-031-13 13,0 cm, 5 1/8"



18-032-12



DERF

18-032-12 12,0 cm, 4 3/4"



18-034-12



DERF-CONVERSE

18-034-12 12,0 cm, 4 3/4"



18-036-13



18-036-13 13,0 cm, 5 1/8"



18-036-15

18-036-15 15,0 cm, 6"



18-037-20
18-037-24
18-037-26
18-037-36

HEANEY

18-037-20	20,0 cm, 8"
18-037-24	24,0 cm, 9 1/2"
18-037-26	26,0 cm, 10 1/4"
18-037-36	36,0 cm, 14 1/4"



18-039-22

18-039-23

STRATTE

18-039-22	22,0 cm, 8 3/4"
18-039-23	23,0 cm, 9"



18-040-18

NEW ORLEANS

18-040-18	18,0 cm, 7"
-----------	-------------



18-041-20

18-041-24

18-041-26

18-041-28

BOZEMANN-S

18-041-20	20,0 cm, 8"
18-041-24	24,0 cm, 9 1/2"
18-041-26	26,0 cm, 10 1/4"
18-041-28	28,0 cm, 11"



18-042-27

Tc
TUNGSTEN

MASSON

18-042-27 27,0 cm, 10 3/4"



18-044-27

Tc
TUNGSTEN

WANGENSTEEN

18-044-27 27,0 cm, 10 3/4"



18-045-27

Tc
TUNGSTEN

FINOCHIETTO

18-045-27 27,0 cm, 10 3/4"



18-046-12

Tc
TUNGSTEN

OLSEN-HEGAR

18-046-12 - 17-046-13 13,0 cm, 5 1/8"



18-046-13

C
5,0 - 12,0



18-048-14

Tc
TUNGSTEN

OLSEN-HEGAR

18-048-14 14,0 cm, 5 1/2"
 18-048-16 16,5 cm, 6 1/2"
 18-048-18 18,0 cm, 7"



18-048-16



18-048-18



18-049-11



18-051-15



18-051-16



Tc
TUNGSTEN

FOSTER-GILLIES

18-049-11 11,0 cm, 4 3/8"



Tc
TUNGSTEN

GILLIES-MINI

18-051-15 15,0 cm, 6"



Tc
TUNGSTEN

GILLIES

18-051-16 16,0 cm, 6 1/4"



Tc
TUNGSTEN

MATHIEU

18-052-14 14,0 cm, 5 1/2"
18-052-17 17,0 cm, 6 3/4"
18-052-20 20,0 cm, 8"



18-052-14



18-052-17



18-052-20



Tc
TUNGSTEN

MATHIEU

18-053-14 14,0 cm, 5 1/2"
18-053-17 17,0 cm, 6 3/4"
18-053-20 20,0 cm, 8"



18-053-14



18-053-17



18-053-20



Tc
TUNGSTEN

18-053-21

18-053-25



Tc
TUNGSTEN

18-053-37

18-053-40

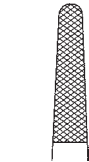

18-053-44

MATHIEU

18-053-21	20,0 cm, 8 "
18-053-25	24,5 cm, 9 2/3 "

MATHIEU

18-053-37	17,0 cm, 6 3/4 "
18-053-40	20,0 cm, 8 "
18-053-44	24,0 cm, 9 1/2 "



Tc
TUNGSTEN

18-054-14

18-054-17

18-054-20



Tc
TUNGSTEN

18-055-14

18-055-17

18-055-20

MATHIEU

18-054-14	14,0 cm, 5 1/2 "
18-054-17	17,0 cm, 6 3/4 "
18-054-20	20,0 cm, 8 "

MATHIEU

18-055-14	14,0 cm, 5 1/2 "
18-055-17	17,0 cm, 6 3/4 "
18-055-20	20,0 cm, 8 "



Tc
TUNGSTEN

18-056-20



Tc
TUNGSTEN

18-057-20



18-057-26

A
0,6 - 4,0

B
4,0 - 6,0

LICHTENBERG

18-056-20 20,0 cm, 8"

18-057-20 20,0 cm, 8"

18-057-26 26,0 cm, 10 1/4"



Tc
TUNGSTEN

18-058-26



Tc
TUNGSTEN

18-066-20



18-066-23

HOESEL

18-058-26 26,0 cm, 10 1/4"

ZWEIFEL

18-066-20 20,0 cm, 8"

18-066-23 23,0 cm, 9"



18-070-18

Tc
TUNGSTEN

TOENNIS

18-070-18 18,0 cm, 7 "



18-071-18

Tc
TUNGSTEN

TOENNIS Modif.

18-071-18 18,0 cm, 7 "



18-072-18

Tc
TUNGSTEN

18-072-20

18-072-23

LANGENBECK

18-072-18 18,0 cm, 7 "
 18-072-20 20,0 cm, 8 "
 18-072-23 23,0 cm, 9 "



18-076-16

18-077-16

Tc
TUNGSTEN

ARRUGA

18-076-16 - 18-077-16 16,0 cm, 6 2/8 "



18-100-14

18-100-18

18-100-20

18-100-23

HEGAR-VASCULAR

18-100-14	14,0 cm, 5 1/2"
18-100-18	18,0 cm, 7"
18-100-20	20,0 cm, 8"
18-100-23	23,0 cm, 9"



18-102-14

18-102-16

18-102-18

18-102-20

HEGAR-VASCULAR

18-102-14	14,0 cm, 5 1/2"
18-102-16	16,0 cm, 6 1/4"
18-102-18	18,0 cm, 7"
18-102-20	20,0 cm, 8"



18-104-14

18-104-16

18-104-18

18-104-20

18-104-23

HEGAR-VASCULAR

18-104-14	14,0 cm, 5 1/2"
18-104-16	16,0 cm, 6 1/4"
18-104-18	18,0 cm, 7"
18-104-20	20,0 cm, 8"
18-104-23	23,0 cm, 9"



18-106-14

18-106-18

18-106-20

18-106-23

MICRO-VASCULAR

18-106-14	14,0 cm, 5 1/2"
18-106-18	18,0 cm, 7"
18-106-20	20,0 cm, 8"
18-106-23	23,0 cm, 9"

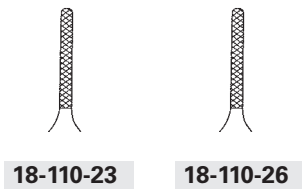
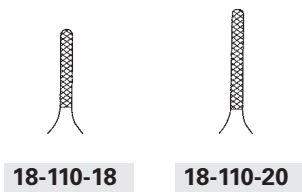
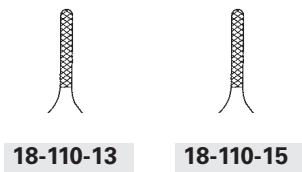

RYDER-VASCULAR

18-110-13	13,0 cm, 5 "
18-110-15	15,0 cm, 6 "
18-110-18	18,0 cm, 7 "
18-110-20	20,0 cm, 8 "
18-110-23	23,0 cm, 9 "
18-110-26	26,0 cm, 10 ½ "

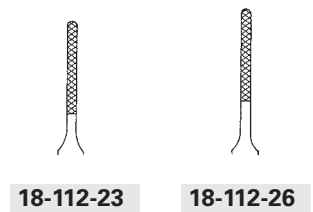
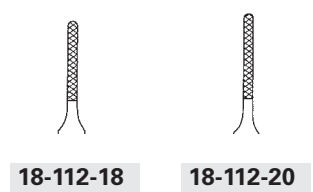
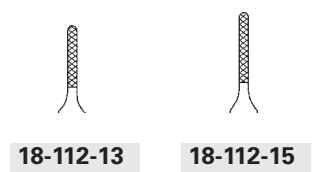

MICRO-RYDER

18-112-13	13,0 cm, 5 "
18-112-15	15,0 cm, 6 "
18-112-18	18,0 cm, 7 "
18-112-20	20,0 cm, 8 "
18-112-23	23,0 cm, 9 "
18-112-26	26,0 cm, 10 ½ "

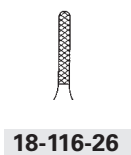
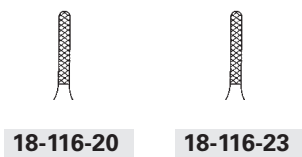
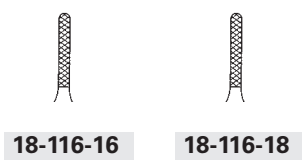

DIETRICH-VASCULAR

18-116-16	16,0 cm, 6 ¼ "
18-116-18	18,0 cm, 7 "
18-116-20	20,0 cm, 8 "
18-116-23	23,0 cm, 9 "
18-116-26	26,0 cm, 10 ½ "

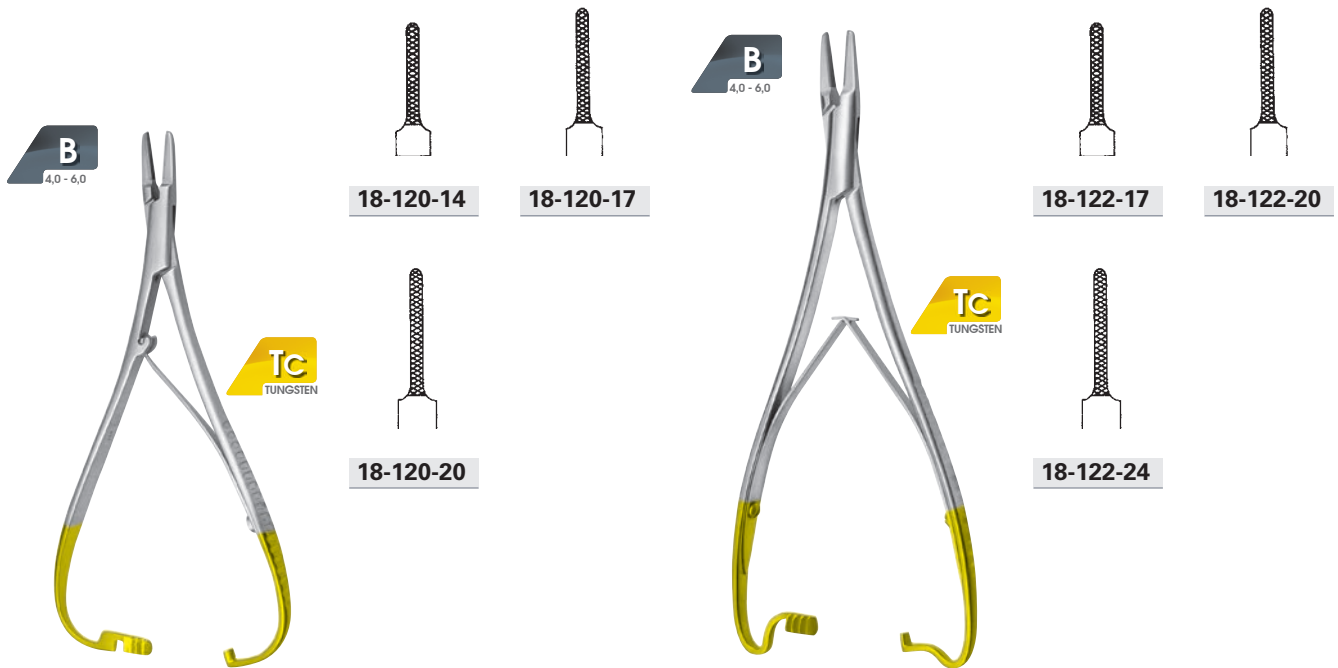

MATHIEU-RYDER

18-120-14	14,0 cm, 5 1/2"
18-120-17	17,0 cm, 6 3/4"
18-120-20	20,0 cm, 8"

MATHIEU-RYDER

18-122-17	17,0 cm, 6 3/4"
18-122-20	20,0 cm, 8"
18-122-24	24,0 cm, 9 1/2"



LANGENBECK-RYDER

18-130-20	20,0 cm, 8"
------------------	-------------



18



Mikro Instrumente

Micro Instruments

Instrumentos de micro

Strumentario micro

Fordern Sie unser Spezialprospekt an
Please ask for our special catalogue
No duden pedirnos más catálogos especiales
Chiedete i nostri cataloghi speciali



20



Neurochirurgie

Neurosurgery

Neurocirugía

Neurochirurgia



20



Mikro Instrumente

Micro Instruments

Instrumentos de micro

Strumentario micro

Fordern Sie unser Spezialprospekt an
Please ask for our special catalogue
No duden pedirnos más catálogos especiales
Chiedete i nostri cataloghi speciali

Kugelenkloben zur Befestigung
des Haltearms an OP-Tisch-Schienen
Ball and socket joint, to fixe holding device
of operating table
Articulación esférica, para sujetar los brazos
de apoyo sobre la mesa de operaciones
Giunto a sfera ad incastro, per il fissaggio
dell'asta all'estremità del tavolo operatorio



LEYLA

20-100-01 10 x 25 mm

Haltearm
Holding device
Brazo
Porta asta



LEYLA

20-100-02

Kupplungskopf zur Aufnahme von 1-5 Spannarmen
Coupling head to hold 1-5 flexible arms
Acoplamiento para sujetar 1-5 brazos
Testa accoppiamento per 1-5 bracci flessibili

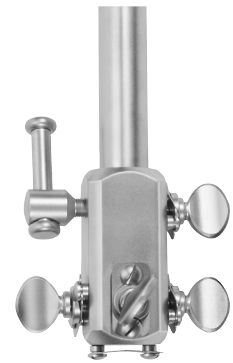

LEYLA

20-100-03

Kupplungskopf, drehbar zur Aufnahme von 1 Spannarm
Coupling head, rotatable to hold 1 flexible arm
Acoplamiento, girable para sujetar 1 brazo
Testa accoppiamento, girevole per 1 bracci flessibili



LEYLA

20-100-04

Kupplungskopf, seitlich offen zur Aufnahme von 1 Spannarm
Coupling head, lateral open to hold 1 flexible arm
Acoplamiento, lateral abierto para sujetar 1 brazo
Testa accoppiamento, laterale aperta per 1 bracci flessibili



LEYLA

20-101-04

Spannarm zum Aufstecken auf Kupplungs-
köpfe 20-100-03 | 20-100-04 | 20-101-04
und Fixiervorrichtungen

Flexible arm to be attached to coupling
heads 20-100-03 | 20-100-04 | 20-101-04
and fixation device

Brazo para colocar sobre el acoplamiento
20-100-03 | 20-100-04 | 20-101-04 y los
fijadores

Braccio flessibile per il fissaggio delle teste
di accoppiamento 20-100-03 | 20-100-04 |
20-101-04 e le basi di fissaggio



LEYLA

20-100-08



Fixiervorrichtung für 1 Spannarm 20-100-08 zum Festschrauben am Schädel
 Fixation device for 1 flexible arm 20-100-08 for skull mounting
 Fijador para 1 brazo 20-100-08 para atornillar al cráneo
 Base di fissaggio per 1 braccio flessibile 20-100-08 per il supporto del cranio



LEYLA

20-100-05

Fixiervorrichtung für 2 Spannarme 20-100-08 zum Festschrauben am Schädel
 Fixation device for 2 flexible arms 20-100-08 for skull mounting
 Fijador para 2 brazos 20-100-08 para atornillar al cráneo
 Base di fissaggio per 2 bracci flessibile 20-100-08 per il supporto del cranio



LEYLA

20-100-06

Fixiervorrichtung für 1 Spannarm 20-100-08 zum Festschrauben an Rohrteilen
 Fixation device for 1 flexible arm 20-100-08 for mounting to bars
 Fijador para 1 brazo 20-100-08 para atornillar al tubos
 Base di fissaggio per 1 braccio flessibile 20-100-08 per il supporto di asta di riccardo



LEYLA

20-100-07 Ø 16,0 mm

Spatelhalter für flache Spatel zur Befestigung am Spannarm 20-100-08
 Holding device for flat brain spatulas, to be fixed at holding device 20-100-08
 Porta-espátula para espátulas planas, parasujetarlo al brazo 20-100-08
 Supporto per spatola cervicale piatta, fissato al braccio flessibile 20-100-08



LEYLA

20-100-09

Spatelhalter für Rundschaft-Spatel zur Befestigung am Spannarm 20-100-08
 Holding device for spatulas with round shaft, to be fixed at holding device 20-100-08
 Porta-espátula con vástago redondo, parasujetarlo al brazo 20-100-08
 Supporto per spatola craniale, fissato al braccio flessibile 20-100-08



LEYLA

20-100-10 Ø 5,5 mm

Ohrtrichterhalter zur Befestigung am Spannarm 20-100-08
 Ear specula holder, to be fixed at holding device 20-100-08
 Soporte para espéculo, parasujetarlo al brazo 20-100-08
 Sostegno per specchio, fissato al braccio flessibile 20-100-08



LEYLA

20-100-13



LEYLA

20-100-11 SET

Selbsthaltender Hirnspatel mit 1 Spannarm komplett, bestehend aus:

1 Spannarm	20-100-08
1 Fixiervorrichtung	20-100-05
1 Spatelhalter	20-100-09

Self-retaining brain retractor with 1 arm complete, consisting of:

1 Flexible arm	20-100-08
1 Fixation device	20-100-05
1 Support for spatulas	20-100-09

Separador automático para el cerebro con 1 brazo, completo compuesto de:

1 Brazo, flexible	20-100-08
1 Fijador	20-100-05
1 Porta-espátula	20-100-09

Autofissatore per retrattore cervicale con 1 braccio, completo composto da:

1 Braccio flessibile	20-100-08
1 Base di fissaggio	20-100-05
1 Supporto per spatole	20-100-09

LEYLA

20-100-12 SET

Selbsthaltender Hirnspatel mit 2 Spannarmen komplett, bestehend aus:

2 Spannarme	20-100-08
1 Fixiervorrichtung	20-100-06
1 Spatelhalter	20-100-09

Self-retaining brain retractor with 2 arms complete, consisting of:

2 Flexible arms	20-100-08
1 Fixation device	20-100-06
1 Support for spatulas	20-100-09

Separador automático para el cerebro con 2 brazos, completo compuesto de:

2 Brazo, flexible	20-100-08
1 Fijador	20-100-06
1 Porta-espátula	20-100-09

Autofissatore per retrattore cervicale con 2 bracci, completo composto da:

2 Braccio flessibile	20-100-08
1 Base di fissaggio	20-100-06
1 Supporto per spatole	20-100-09



20-110-08	7 8 mm
20-110-11	10 11 mm
20-110-14	13 14 mm
20-110-17	16 17 mm
20-110-20	19 20 mm
20-110-25	22 25 mm

biegsam
malleable
maleable
malleabile

HEIFETZ

20-110-08 - 20-110-25 20,0 cm, 8 "



20-115-08	8 mm
20-115-11	11 mm
20-115-14	14 mm
20-115-17	17 mm

biegsam
malleable
maleable
malleabile

HEIFETZ

20-115-08 - 20-115-17 15,5 cm, 6 1/8 "



20-120-14	14mm
20-120-17	17 mm
20-120-20	20 mm

biegsam
malleable
maleable
malleabile

HEIFETZ

20-120-14 - 20-120-20 20,0 cm, 8 "



20-122-07	7 9 mm
20-122-11	11 13 mm
20-122-15	15 18 mm
20-122-18	18 22 mm

biegsam
malleable
maleable
malleabile

CUSHING

20-122-07 - 20-122-18 18,0 cm, 7 "



20-124-07	7 9 mm
20-124-11	11 13 mm
20-124-15	15 18 mm
20-124-18	18 22 mm

konkav, biegsam
concave, malleable
cóncavas, maleable
concave, malleabile

OLIVECRONA

20-124-07 - 20-124-18 18,0 cm, 7 "

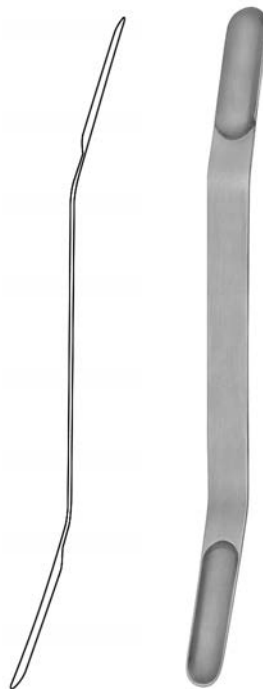

20-125-07	7 9 mm
20-125-11	11 13 mm
20-125-15	15 18 mm
20-125-18	18 22 mm

kovex, biegsam
convex, malleable
cóncavas, maleable
convesse, malleabile

OLIVECRONA

20-125-07 - 20-125-18 18,0 cm, 7 "



20-125-29	9 mm
20-125-32	12 mm
20-125-34	14 mm
20-125-38	18 mm
20-125-40	20 mm
20-125-45	25 mm

biegsam, aus spezieller MEMORY-Legierung, verformt sich bei der Sterilisation automatisch in den ursprünglich geraden Zustand

malleable, made of special MEMORY alloy, straightens out automatically during sterilisation process

flexible, Fabricado en una aleación especial MEMORY, recobra la forma recta original de forma automática durante la esterilización

pieghevole, realizzato in speciale lega a memoria di forma, che in seguito a sterilizzazione ritorna automaticamente alla forma diritta originaria

MEMORY

20-125-29 - 20-125-45 20,0 cm, 8 "



16-074-01	6 mm
16-074-02	8 mm
16-074-03	10 mm
16-074-04	12 mm
16-074-05	17 mm
16-074-06	25 mm

biegsam
malleable
maleable
malleabile

16-074-01 - 16-074-06 20,0 cm, 8 "

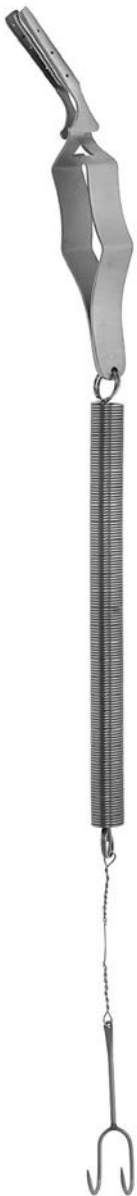

7,0 mm

20-126-07

Federhaken zur Galea-Fixation mit Bulldog-Klemme zum Befestigen am Abdecktuch.
 Spring hooks for galea fixation with bulldog clamp, to be fixed at covering drape.
 Ganchos con muelle para la fijación de la galea, con pinza de bulldog para agarrar tela.
 Ganci a molla per fissare la galea con clamp bulldog, da applicare al telo di copertura.



9,0 mm

20-126-09

Federhaken zur Galea-Fixation mit Bulldog-Klemme zum Befestigen am Abdecktuch.
 Spring hooks for galea fixation with bulldog clamp, to be fixed at covering drape.
 Ganchos con muelle para la fijación de la galea, con pinza de bulldog para agarrar tela.
 Ganci a molla per fissare la galea con clamp bulldog, da applicare al telo di copertura.

YASARGIL

20-126-07 31,0 cm, 12 1/4"

YASARGIL

20-126-09 41,0 cm, 16 1/4"

Anlege- und Abnehmezange
Applying and removing forceps
Pinza para aplicar y quitar clips
Pinza per applicare e togliere le agrafo



RANEY

20-130-00 16,0 cm, 6 1/4"



Verpackungseinheit: 1 St.
Packing unit: 1 piece
Unidad: 1 pieza
Confezione: 1 pezza

Kopfhautklammern
Scalp clips
Pinza haemostática para cuero cabelludo
Agrafas emostatici per cuoio capelluto



RANEY

20-131-00



Verpackungseinheit: 50 St.
Packing unit: 50 pieces
Unidad: 50 piezas
Confezione: 50 pezzi

Kopfhautklammern
Scalp clips
Pinza haemostática para cuero cabelludo
Agrafas emostatici per cuoio capelluto



KOELNER

20-132-00



Verpackungseinheit: 100 St.
Packing unit: 100 pieces
Unidad: 100 piezas
Confezione: 100 pezzi

Silberklammern in Plastikbehälter
Silver brain clips in plastic box
Grapas de plata en tubo de plástico
Agrafas de argento, contenuti in piccoli tubi



MC KENZIE

20-133-00

Silberklammernblock
Silver clip carrier
Porta-rapas
Supporto porta-agrafo



MC KENZIE

20-134-01 148x40x6 mm

Silberklammernblock
Silver clip carrier
Porta-rapas
Supporto porta-agrafo

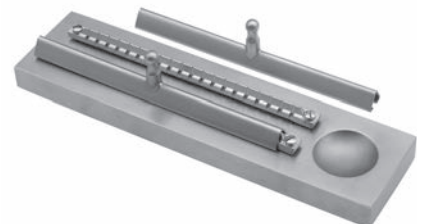

MC KENZIE

20-134-02 190x48x13mm



20-136-15
20-136-19

gerade
 straight
 recta
 retta



20-137-15
20-137-19

gebogen
 curved
 curva
 curvo

Klammer Anlegezange für Silberklammern
 Clip applying forceps for silver clips
 Pinzas clipadoras para las grapas de plata
 Pinze metti agrafes per agrafes in argento



20-138-23
20-138-26

gerade
 straight
 recta
 retta

Klammer Anlegezange für Silberklammern
 Clip applying forceps for silver clips
 Pinzas clipadoras para las grapas de plata
 Pinze metti agrafes per agrafes in argento

MC KENZIE

20-136-15 - 20-137-15 15,0 cm, 6 "
20-136-19 - 20-137-19 19,0 cm, 7 ½ "

SWEET

20-138-23 23,0 cm, 9 "
20-138-26 26,0 cm, 10 ¼ "



20-139-23
20-139-26

gebogen
 curved
 curva
 curvo

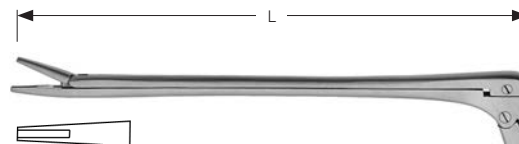

Klammer-Anlegezange für Silberklammern
 Clip applying forceps for silver clips
 Pinzas clipadoras para las grapas de plata
 Pinze metti agrafes per agrafes in argento

SMITHWICK

20-139-23 23,0 cm, 9 "
20-139-26 26,0 cm, 10 ¼ "

OLIVECRONA-TOENNIS

20-140-14 14,0 cm, 5 ½ "

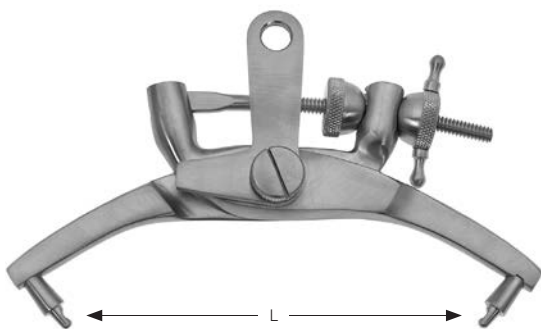

CRUTCHFIELD

20-150-01 10,5 cm, 4 1/4"

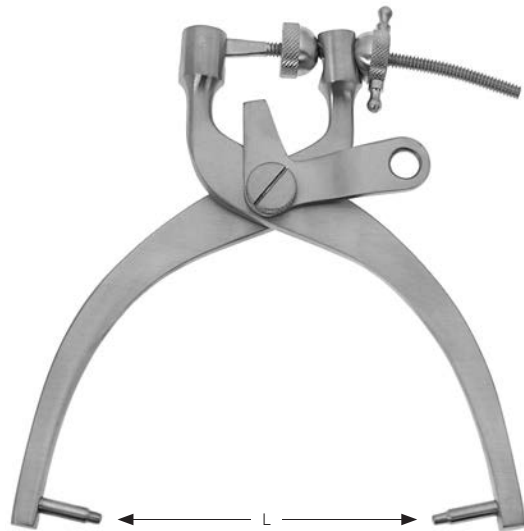

CRUTCHFIELD

20-150-02 15,5 cm, 6 1/8"



20-151-00

Ersatzdorn
Spare pin
Punta de requesto
Punta di scorta

CRUTCHFIELD

20-150-03 17,5 cm, 7"

Schädelhalter für Extension der Halswirbel, großes Modell, Dorne verstellbar, deshalb vorbohren nicht erforderlich.

Cervical traction tongs, for extension of the neck vertebrae, large size, pins adjustable hence no initial drilling.

Pinza de tracción craneal para la extensión de las vertebrae de cuello, tamaño grande, puntas ajustables suprimiendo perforaciones iniciales.

Pinza per trazione craniale e l'estensione delle vertebre del collo, modello grande, punte regolabili al fine di evitare la perforazione iniziale.

Vorbohrer für CRUTCHFIELD-Schädelhalter
Drill point for CRUTCHFIELD cervical traction tongs
Perforador inicial pinzas de tracción craneal CRUTCHFIELD
Alesatore per pinze di trazione craniale di CRUTCHFIELD



CRUTCHFIELD

20-152-35 Ø 3,5 mm



CRUTCHFIELD

20-152-50 Ø 5,0 mm



DAHLGREN

20-154-20 20,0 cm, 8 "



DE VILBISS

20-156-21 21,0 cm, 8 ¼ "



Schädelstanzzange bis 12 mm Schädelstärke
 Cranial punch rongeur for max. 12 mm of bone
 Pinza saca-bocados craneal para craneo hasta 12 mm
 Pinza per cranio, asta 12 mm

CONE

20-156-22 22,5 cm, 9 "



DE MARTEL

20-158-33 33,0 cm, 13 "



LEBSCHÉ

20-159-25 25,0 cm, 10 "

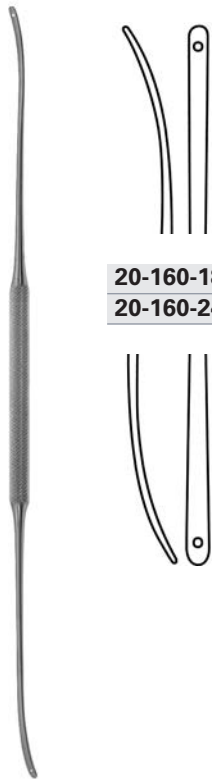

20-160-18
20-160-24

OLIVECRONA

20-160-18	18,0 cm, 7"
20-160-24	24,0 cm, 9 1/2"

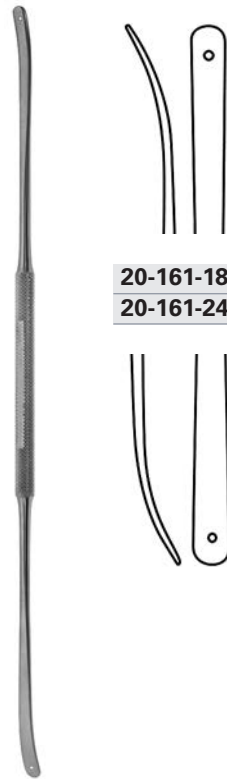

20-161-18
20-161-24

OLIVECRONA

20-161-19	19,0 cm, 7 3/4"
20-161-24	24,0 cm, 9 1/2"



3,0 mm
20-163-03

SACHS

20-163-03	21,0 cm, 8 1/4"
------------------	-----------------



6,0 mm
20-163-06

SACHS

20-163-06	21,0 cm, 8 1/4"
------------------	-----------------

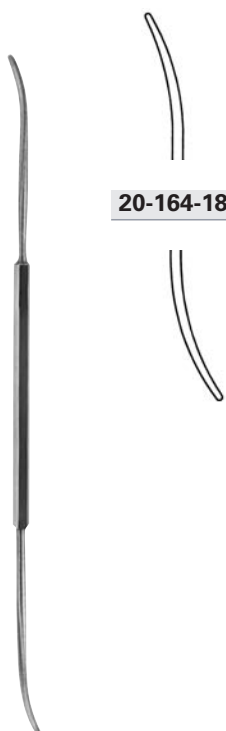

20-164-18

SWEDISH

20-164-18	18,0 cm, 7"
------------------	-------------

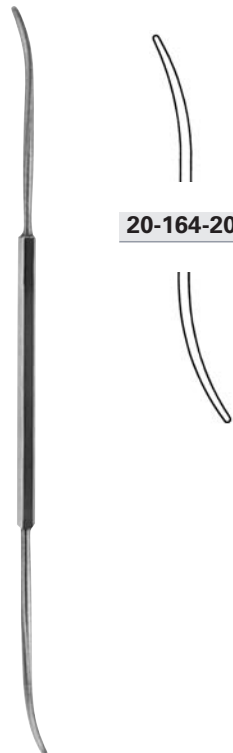

20-164-20

SWEDISH

20-164-20	20,0 cm, 8"
------------------	-------------

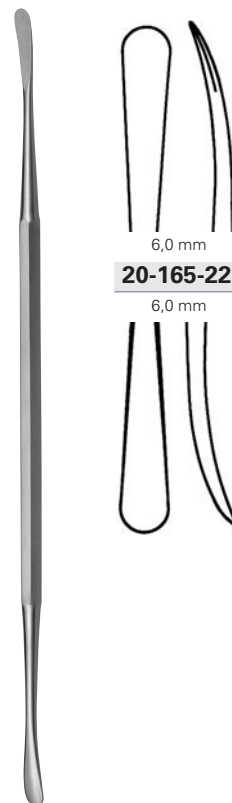

6,0 mm
20-165-22
6,0 mm

20-165-22	22,0 cm, 8 3/4"
------------------	-----------------

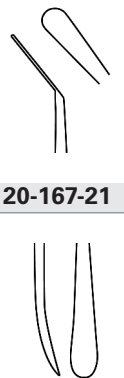

20-167-21

MILLIGAN

20-167-21	21,0 cm, 8"
------------------	-------------



20-169-21

SACHS

20-169-21 21,0 cm, 8 ¼"

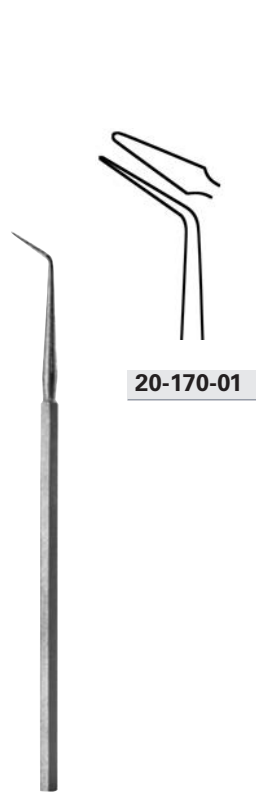

20-170-01

FRAZIER

20-170-01 15,0 cm, 6"

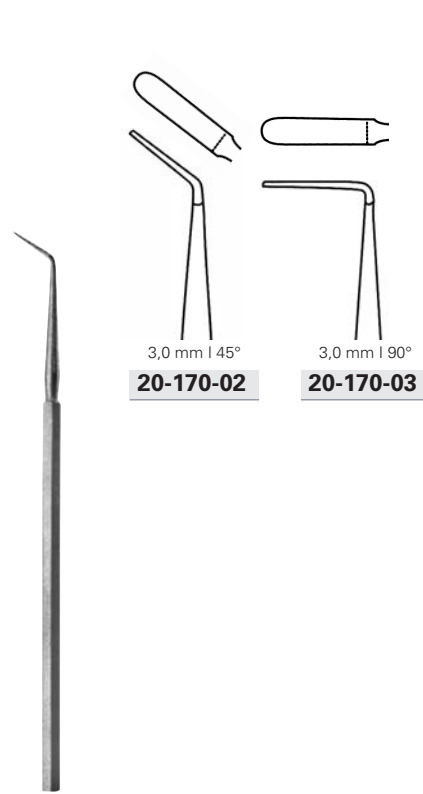

3,0 mm | 45°
20-170-02

3,0 mm | 90°
20-170-03

HOEN

20-170-02 -20-170-03 15,0 cm, 6"

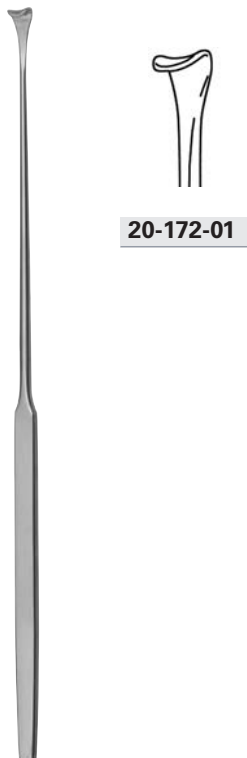

20-172-01

LOVE

20-172-01 20,0 cm, 8"

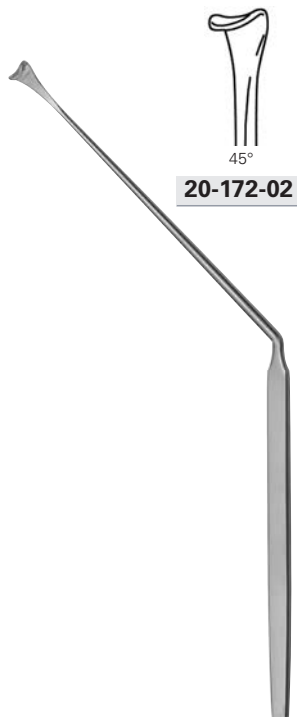

45°
20-172-02

LOVE

20-172-02 18,0 cm, 7"



90°
20-172-03

LOVE

20-172-03 14,0 cm, 5 ½"

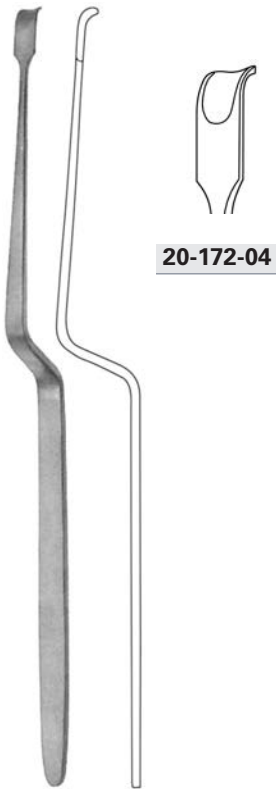

20-172-04

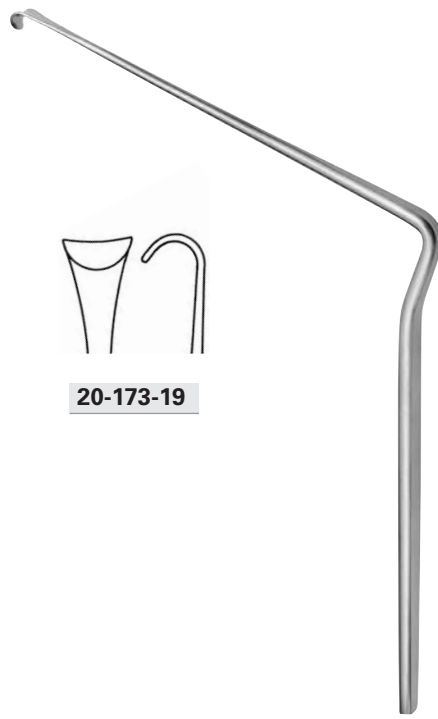

20-173-19

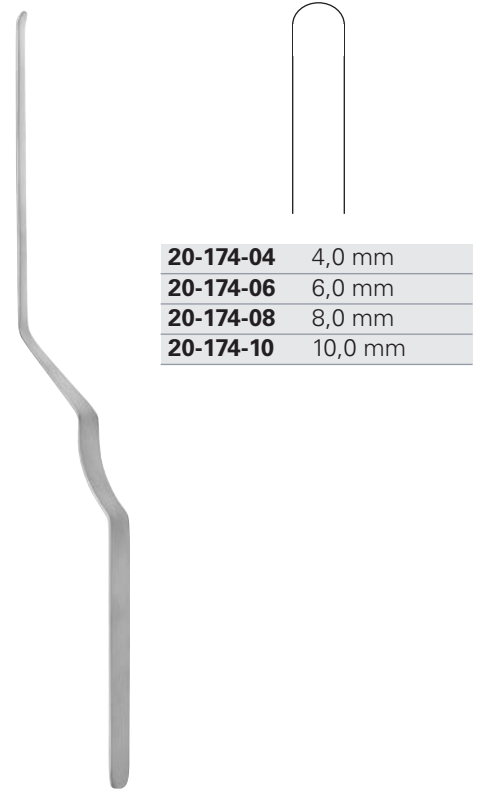

20-174-04	4,0 mm
20-174-06	6,0 mm
20-174-08	8,0 mm
20-174-10	10,0 mm

LOVE

20-172-04 22,5 cm, 9"

CASPAR

20-174-04 - 20-174-10 24,0 cm, 9 ½"

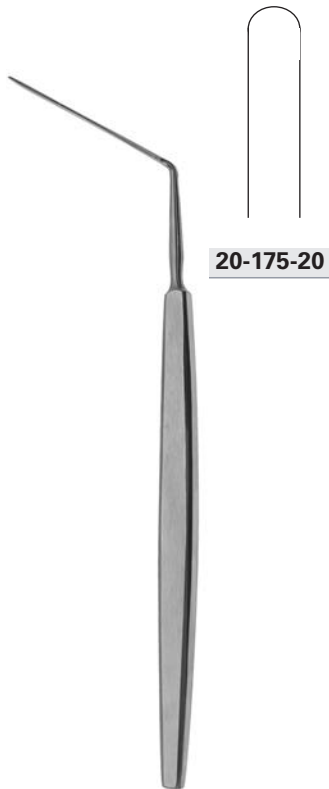

20-175-20

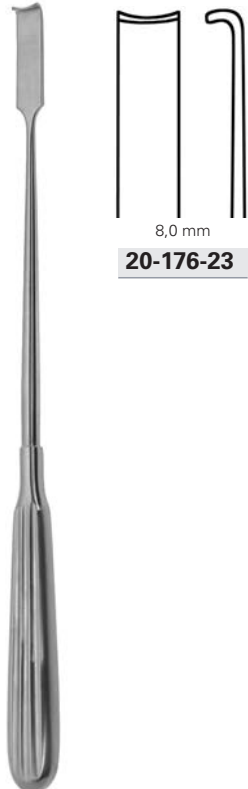

8,0 mm
20-176-23

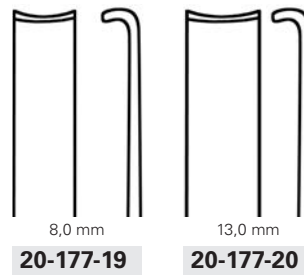

8,0 mm
20-177-19

13,0 mm
20-177-20

HORSLEY

20-175-20 20,0 cm, 8"

SCOVILLE

20-176-23 23,0 cm, 9"

SCOVILLE

20-177-19 - 20-177-20 19,0 cm, 7 ½"

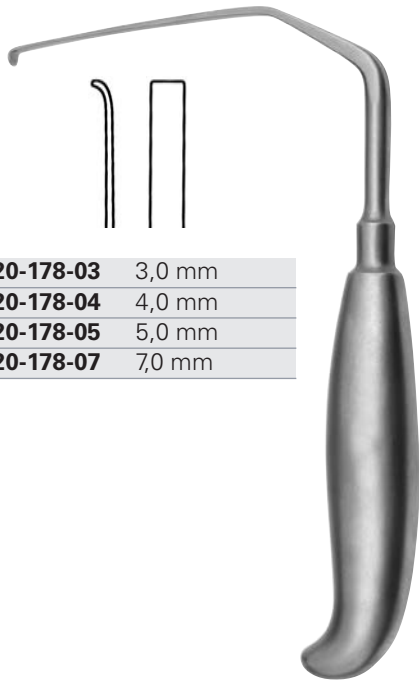

20-178-03	3,0 mm
20-178-04	4,0 mm
20-178-05	5,0 mm
20-178-07	7,0 mm

LOVE

20-178-03 - 20-178-07 11,0 cm, 4 3/8 "



20-179-24

HOLSHER

20-179-24 24,0 cm, 9 1/2 "



20-181-18	18,0 mm
20-181-20	20,0 mm
20-181-23	23,0 mm

CLOWARD

20-181-18 - 20-181-23 18,0 cm, 7 "



20-182-20

Duramesser
 Dura knife
 Cuchillo para dura-madré
 Coltello per dura-madre

HALLE

20-182-20 20,0 cm, 8 "



20-185-01



20-185-02

GRONINGEN

20-185-01 - 20-185-02 26,0 cm, 10 ¼"



20-187-17



20-187-21

SMITHWICK

20-187-17 17,0 cm, 6 ¾"
20-187-21 21,0 cm, 8 ¼"



20-188-20

DANDY

20-188-20 20,0 cm, 8"



20-189-20



20-190-20

ADSON

20-189-20 - 20-190-20 20,0 cm, 8"



20-191-16

GRAHAM

20-191-16 16,5 cm, 6 ½"



20-192-18

SACHS

20-192-18 18,5 cm, 7 ¼"

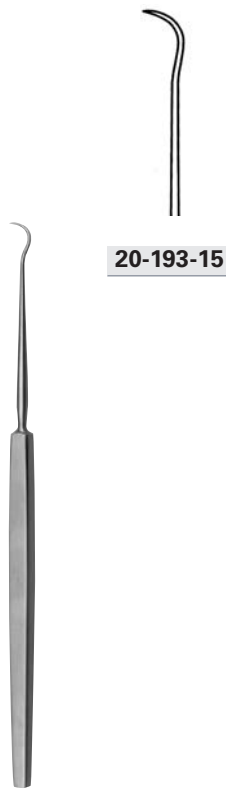

20-193-15

TOENNIS

20-193-15 15,0 cm, 6 "



20-194-14

CUSHING

20-194-14 14,0 cm, 5 1/2 "

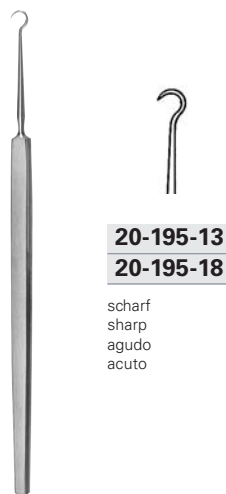

20-195-13
 20-195-18

scharf
 sharp
 agudo
 acuto

20-196-13

stumpf
 blunt
 romo
 smusso

FRAZIER

20-195-13 - 20-196-13 13,0 cm, 5 1/8 "
 20-195-18 18,0 cm, 7 "



20-196-20

ADSON

20-196-20 20,0 cm, 8 "





max. Spreizweite 170 mm
max. spread 170 mm
apertura máxima 170 mm
apertura massima 170 mm

SCOVILLE-RICHTER

20-300-00 SET

Komplett, bestehend aus:		Complete, consisting of:	
1 Sperrer	20-300-01	1 Spreader	20-300-01
1 Paar Seitenválven	20-300-02	1 Pair lateral valves	20-300-02
Completo, compuesto de:		Completo, composto da:	
1 Separador	20-300-01	1 Divaricatore	20-300-01
1 Par valvas laterales	20-300-02	1 Paio valve laterali	20-300-02



62 x 52 mm

62 x 37 mm



SCOVILLE-RICHTER

20-300-02

SCOVILLE-RICHTER

20-300-03 47 x 51 mm

SCOVILLE-RICHTER

20-300-04 30 x 40 mm

SCOVILLE-RICHTER

20-300-05 37 x 62 mm

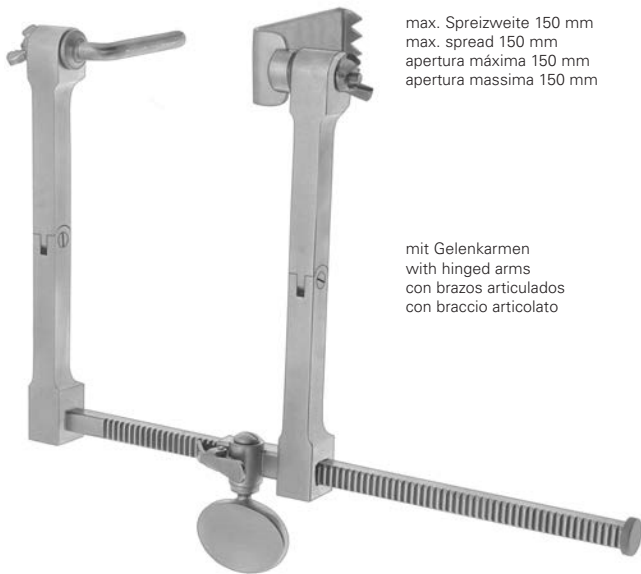

max. Spreizweite 150 mm
max. spread 150 mm
apertura máxima 150 mm
apertura massima 150 mm

mit Gelenkarmen
with hinged arms
con brazos articulados
con braccio articolato

SCOVILLE-HAVERFIELD

20-302-00 SET

Komplett, bestehend aus:		Complete, consisting of:	
1 Sperrer	20-302-01	1 Spreader	20-302-01
1 Haken 50 mm	20-302-02	1 Hook 50 mm	20-302-02
1 Seitenvalve 64x25mm	20-302-03	1 Lateral valve 64x25mm	20-302-03
Completo, compuesto de:		Completo, composto da:	
1 Separador	20-302-01	1 Divaricatore	20-302-01
1 Gancho 50 mm	20-302-02	1 Gancio 50 mm	20-302-02
1 Valva laterales 64x25mm	20-302-03	1 Valve laterale 64x25mm	20-302-03



stumpf
blunt
romo
smusso



SCOVILLE

20-302-02 50 mm

SCOVILLE

20-302-03 64 x 25 mm
20-302-04 64 x 50 mm

SCOVILLE

20-302-05 44 x 38 mm

SCOVILLE

20-302-06 62 x 52 mm



max. Spreizweite 150 mm
max. spread 150 mm
apertura máxima 150 mm
apertura massima 150 mm

SCOVILLE

20-303-00 SET

Komplett, bestehend aus:	Complete, consisting of:
1 Sperrer 20-303-01	1 Spreader 20-303-01
1 Haken 50 mm 20-303-04	1 Hook 50 mm 20-303-04
1 Seitenvalve 64x25mm 20-303-06	1 Lateral valve 64x25mm 20-303-06

Completo, compuesto de:	Completo, composto da:
1 Separador 20-303-01	1 Divaricatore 20-303-01
1 Gancho 50 mm 20-303-04	1 Gancio 50 mm 20-303-04
1 Valva laterales 64x25mm 20-303-06	1 Valve laterale 64x25mm 20-303-06



stumpf
blunt
romo
smusso

SCOVILLE

20-303-02	50 mm
20-303-03	70 mm



scharf
sharp
agudo
acuto



SCOVILLE

20-303-04	50 mm
20-303-05	70 mm

SCOVILLE

20-303-06	64 x 25 mm
20-303-07	64 x 50 mm
20-303-08	88 x 25 mm

TAYLOR

20-303-11	48 x 50 mm
20-303-12	64 x 50 mm
20-303-13	64 x 64 mm
20-303-14	80 x 57 mm

SCOVILLE

20-303-15	41 x 38 mm
20-303-16	67 x 44 mm

Wundspreizer, Seitenvalven 50 x 43 mm
Self-retaining retractor, lateral valves 50 x 43 mm
Separador, vlvas laterales 50 x 43 mm
Divaricatore, valve laterali 50 x 43 mm

max. Spreizweite 165 mm
max. spread 165 mm
apertura máxima 165 mm
apertura massima 165 mm

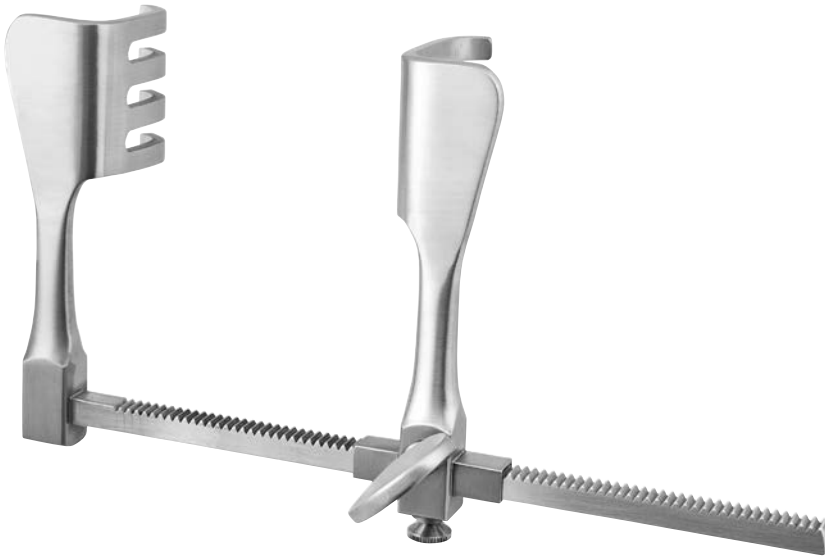

BAGDLEY

20-305-00



Messschieber zum Vermessen des
Knochenspans und des Span-Situs
Caliper, for measuring the bone
graft and graft side
Pies de rey para medir esquirlas óseas y
determinar la posición en el que se encuentran éstas
Calibro per misurare innesti ossei
e i relativi siti di innesto

CASPAR

20-310-22 140 mm



CASPAR

20-313-00 SET

links
left
zurdo
sinistra

Komplett, bestehend aus:

1 Distraktor, links	20-315-01
1 Bohrlehre, links	20-318-00
1 Bohrer, Ø 1,7 mm	20-320-17
2 Distractionsschrauben	20-315-16
1 Schraubendreher	20-322-20

Complete, consisting of:

1 Distractor, left	20-315-01
1 Drill guide, left	20-318-00
1 Drill, Ø 1,7 mm	20-320-17
2 Distraction screws	20-315-16
1 Screw driver	20-322-20

Completo, compuesto de:

1 Distractor, zurdo	20-315-01
1 Guia-taladro, zurdo	20-318-00
1 Broca, Ø 1,7 mm	20-320-17
2 Tornillos de distraccion	20-315-16
1 Destornillador	20-322-20

Completo, composto da:

1 Distrattori, sinistra	20-315-01
1 Guida-trapano, sinistra	20-318-00
1 Trapano, Ø 1,7 mm	20-320-17
2 Viti di distrazione	20-315-16
1 Cacciavite	20-322-20

Bohrer zum Vorbohren
Drill for rough drilling
Broca para la perforación
Perforatore per la perforazione iniziale



CASPAR

20-320-17 Ø 1,7 mm



CASPAR

20-314-00 SET

rechts
right
derecho
destra

Komplett, bestehend aus:

1 Distraktor, rechts	20-315-00
1 Bohrlehre, rechts	20-317-00
1 Bohrer, Ø 1,7 mm	20-320-17
2 Distractionsschrauben	20-315-16
1 Schraubendreher	20-322-20

Complete, consisting of:

1 Distractor, right	20-315-00
1 Drill guide, right	20-317-00
1 Drill, Ø 1,7 mm	20-320-17
2 Distraction screws	20-315-16
1 Screw driver	20-322-20

Completo, compuesto de:

1 Distractor, derecho	20-315-00
1 Guia-taladro, derecho	20-317-00
1 Broca, Ø 1,7 mm	20-320-17
2 Tornillos de distraccion	20-315-16
1 Destornillador	20-322-20

Completo, composto da:

1 Distrattori, destra	20-315-00
1 Guida-trapano, destra	20-317-00
1 Trapano, Ø 1,7 mm	20-320-17
2 Viti di distrazione	20-315-16
1 Cacciavite	20-322-20



Distractionsschrauben
Distraction screws
Tornillos de distraccion
Viti di distrazione

CASPAR

20-315-12	12,0 mm
20-315-14	14,0 mm
20-315-16	16,0 mm
20-315-18	18,0 mm



rechts
right
derecho
destra



CASPAR

20-317-00



links
left
zurdo
sinistra



CASPAR

20-318-00



Schraubendreher
Screw driver
Destornillador
Cacciavite



CASPAR

20-322-20 20,0 cm, 8 "



rechts
right
derecho
destra

CASPAR

20-315-00 kurz | short | corto | corto

20-316-00 lang | long | largo | lungo



links
left
zurdo
sinistra

CASPAR

20-315-01 kurz | short | corto | corto

20-316-01 lang | long | largo | lungo

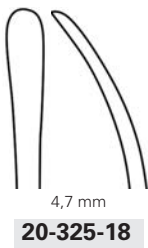

LANDOLT

20-325-18 17,5 cm, 7 "

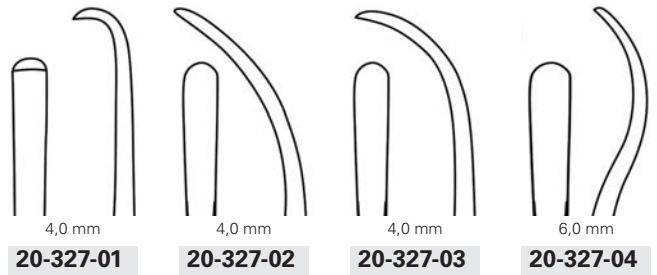
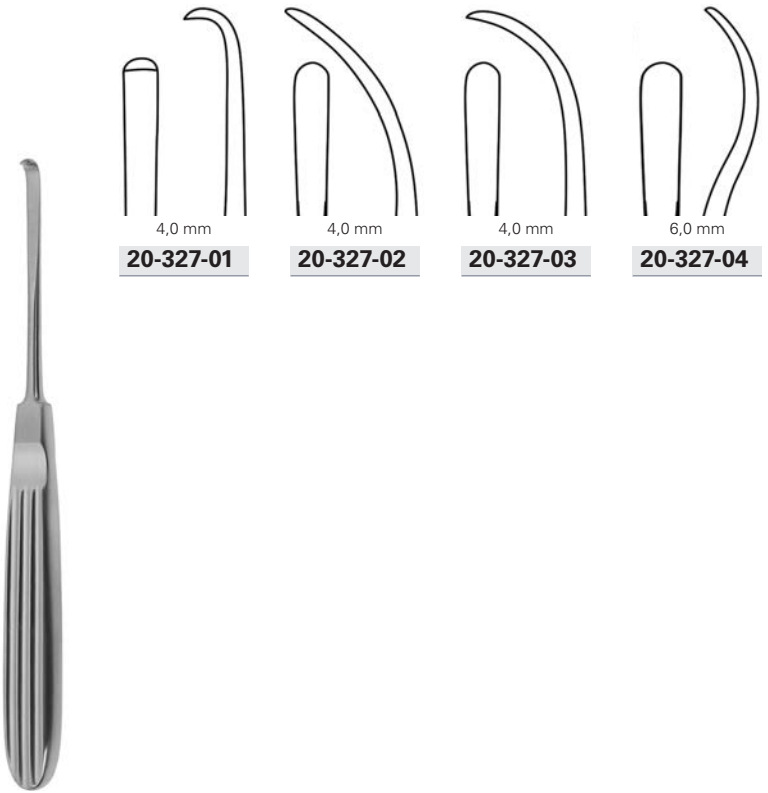

MUEHLING

20-327-01 - 20-327-04 17,0 cm, 6 ¾ "

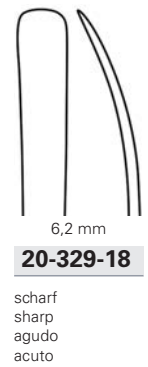
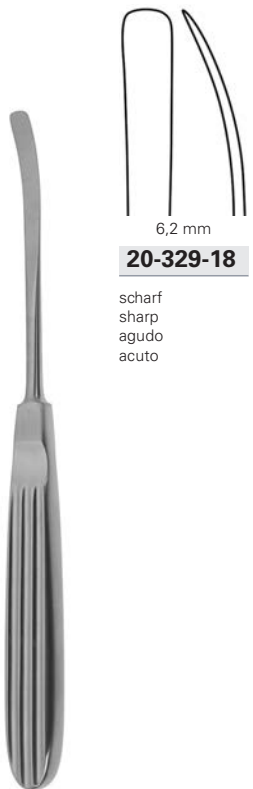

CASPAR

20-329-18 18,0 cm, 7 "

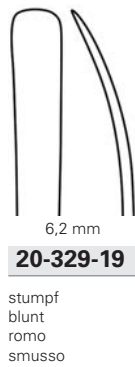

CASPAR

20-329-19 18,0 cm, 7 "



CASPAR

20-331-01 - 20-331-02 20,5 cm, 8 "



CASPAR

20-331-01 P - 20-331-02 P 20,5 cm, 8 "

Weitere Raspatorien finden Sie in in Produktgruppe 40.
More raspatories you will find in product group 40.
Encontrará más raspadores en el grupo de productos 40.
Diversi periostotomi si trovano nel gruppo prodotti 40.



max. Spreizweite 145 mm
max. spread 145 mm
apertura máxima 145 mm
apertura massima 145 mm

Lumbal, thorakal und cervical einzusetzen
For use of lumbar, thoracic and cervical
Util para lumbar, toracal y cervical
Per impiego lombare, toracico e cervicale

CASPAR

20-350-00 SET



Wundspreizer mit Gelenkarmen und Kugelschnellverschluß, für Laminektomie und Hemi-Laminektomie, komplett, bestehend aus:

1 Rahmen	20-350-01
1 Schlüssel	20-350-02
1 Haken, 38 mm	20-351-13
1 Seitenvalve, 37x22 mm	20-352-37
1 Seitenvalve, 43x22 mm	20-352-43
1 Seitenvalve, 47x22 mm	20-352-47
1 Seitenvalve, 52x22 mm	20-352-52
1 Seitenvalve, 57x22 mm	20-352-57

Self-retaining retractor with hinged arms and ball snap closure, for laminectomy and hemi-laminectomy, complete, consisting of:

1 Frame	20-350-01
1 Key	20-350-02
1 Hook, 38 mm	20-351-13
1 Lateral valve, 37x22 mm	20-352-37
1 Lateral valve, 43x22 mm	20-352-43
1 Lateral valve, 47x22 mm	20-352-47
1 Lateral valve, 52x22 mm	20-352-52
1 Lateral valve, 57x22 mm	20-352-57

Separador con brazos articulados y cierre rápido esférico, para laminectomía y hemilaminectomía, completo, compuesto de:

1 Cuadro	20-350-01
1 Llave	20-350-02
1 Gancho, 38 mm	20-351-13
1 Valva lateral, 37x22 mm	20-352-37
1 Valva lateral, 43x22 mm	20-352-43
1 Valva lateral, 47x22 mm	20-352-47
1 Valva lateral, 52x22 mm	20-352-52
1 Valva lateral, 57x22 mm	20-352-57

Divaricatore con braccio articolato a chiusura istantanea, per laminectomia e emi-laminectomia, completo, composto da:

1 Telaio	20-350-01
1 Chiave	20-350-02
1 Gancio, 38 mm	20-351-13
1 Valva laterale 37x22 mm	20-352-37
1 Valva laterale 43x22 mm	20-352-43
1 Valva laterale 47x22 mm	20-352-47
1 Valva laterale 52x22 mm	20-352-52
1 Valva laterale 57x22 mm	20-352-57



20-351-13

38 mm



20-352-37

37 x 22 mm



20-352-43

43 x 22 mm



20-352-47

47 x 22 mm



20-352-52

52 x 22 mm



20-352-57

57 x 22 mm

20-350-02



Pinzette zum Valvenwechsel bei Kugelschnellverschluß-System
Forceps for changing valves with ball snap closure system
Pinza para el cambio de valvas con el sistema de cierre rápido esférico
Pinza per il cambio delle valve a chiusura istantanea



20-358-99 11,5 cm, 4 ½"



Schlüssel
Key
llave
Chiave



20-350-02 16,0 cm, 6 ¼"



Haken mit Kugelschnellverschluss
Hooks with ball snap closure
Ganchos con cierre rápido esférico
Ganci a chiusura istantanea



20-351-13 38 mm

20-351-15 58 mm



Seitenvalven mit Kugelschnellverschluss
Lateral valves with ball snap closure
Valvas laterales con cierre rápido esférico
Valve laterali a chiusura istantanea



20-352-32 32 x 22 mm

20-352-37 37 x 22 mm

20-352-43 43 x 22 mm

20-352-47 47 x 22 mm

20-352-52 52 x 22 mm

20-352-57 57 x 22 mm

20-352-62 62 x 22 mm

20-352-67 67 x 22 mm



Seitenvalven mit Kugelschnellverschluss
Lateral valves with ball snap closure
Valvas laterales con cierre rápido esférico
Valve laterali a chiusura istantanea



20-353-32 32 x 37 mm

20-353-37 37 x 37 mm

20-353-43 43 x 37 mm

20-353-47 47 x 37 mm

20-353-52 52 x 37 mm

20-353-57 57 x 37 mm

20-353-62 62 x 37 mm

20-353-67 67 x 37 mm

20-353-70 70 x 37 mm



Seitenvalven mit Kugelschnellverschluss
Lateral valves with ball snap closure
Valvas laterales con cierre rápido esférico
Valve laterali a chiusura istantanea



20-354-32 32 x 52 mm

20-354-37 37 x 52 mm

20-354-43 43 x 52 mm

20-354-47 47 x 52 mm

20-354-52 52 x 52 mm

20-354-57 57 x 52 mm

20-354-62 62 x 52 mm

20-354-67 67 x 52 mm

20-354-70 70 x 52 mm



max. Spreizweite 145 mm
max. spread 145 mm
apertura máxima 145 mm
apertura massima 145 mm

CASPAR

20-350-10 SET



Wundspreizer mit Kugelschnellverschluss, für Laminektomie und Hemi-Laminektomie, komplett, bestehend aus:

1 Rahmen	20-350-11
1 Haken, 38 mm	20-351-13
1 Seitenvalve, 37x22 mm	20-352-37
1 Seitenvalve, 43x22 mm	20-352-43
1 Seitenvalve, 47x22 mm	20-352-47
1 Seitenvalve, 52x22 mm	20-352-52
1 Seitenvalve, 57x22 mm	20-352-57

Self-retaining retractor with ball snap closure, for laminectomy and hemi-laminectomy, complete, consisting of:

1 Frame	20-350-11
1 Hook, 38 mm	20-351-13
1 Lateral valve, 37x22 mm	20-352-37
1 Lateral valve, 43x22 mm	20-352-43
1 Lateral valve, 47x22 mm	20-352-47
1 Lateral valve, 52x22 mm	20-352-52
1 Lateral valve, 57x22 mm	20-352-57

Separador con cierre rápido esférico, para laminectomía y hemilaminectomía, completo, compuesto de:

1 Cuadro	20-350-11
1 Gancho, 38 mm	20-351-13
1 Valva lateral, 37x22 mm	20-352-37
1 Valva lateral, 43x22 mm	20-352-43
1 Valva lateral, 47x22 mm	20-352-47
1 Valva lateral, 52x22 mm	20-352-52
1 Valva lateral, 57x22 mm	20-352-57

Divaricatore con chiusura istantanea, per laminectomia e emi-laminectomia, completo, composto da:

1 Telaio	20-350-11
1 Gancio, 38 mm	20-351-13
1 Valva laterale 37x22 mm	20-352-37
1 Valva laterale 43x22 mm	20-352-43
1 Valva laterale 47x22 mm	20-352-47
1 Valva laterale 52x22 mm	20-352-52
1 Valva laterale 57x22 mm	20-352-57



20-351-13

38 mm

20-352-37

37 x 22 mm

20-352-43

43 x 22 mm

20-352-47

47 x 22 mm

20-352-52

52 x 22 mm

20-352-57

57 x 22 mm



Pinzette zum Valvenwechsel bei Kugelschnellverschuß-System
 Forceps for changing valves with ball snap closure system
 Pinza para el cambio de valvas con el sistema de cierre rápido esférico
 Pinza per il cambio delle valve a chiusura istantanea



20-358-99 11,5 cm, 4 ½ "



Haken mit Kugelschnellverschluss
 Hooks with ball snap closure
 Ganchos con cierre rápido esférico
 Ganci a chiusura istantanea



20-351-13 38 mm
20-351-15 58 mm



Seitenvalven mit Kugelschnellverschluss
 Lateral valves with ball snap closure
 Valvas laterales con cierre rápido esférico
 Valve laterali a chiusura istantanea



20-352-32	32 x 22 mm
20-352-37	37 x 22 mm
20-352-43	43 x 22 mm
20-352-47	47 x 22 mm
20-352-52	52 x 22 mm
20-352-57	57 x 22 mm
20-352-62	62 x 22 mm
20-352-67	67 x 22 mm



Seitenvalven mit Kugelschnellverschluss
 Lateral valves with ball snap closure
 Valvas laterales con cierre rápido esférico
 Valve laterali a chiusura istantanea



20-353-32	32 x 37 mm
20-353-37	37 x 37 mm
20-353-43	43 x 37 mm
20-353-47	47 x 37 mm
20-353-52	52 x 37 mm
20-353-57	57 x 37 mm
20-353-62	62 x 37 mm
20-353-67	67 x 37 mm
20-353-70	70 x 37 mm



Seitenvalven mit Kugelschnellverschluss
 Lateral valves with ball snap closure
 Valvas laterales con cierre rápido esférico
 Valve laterali a chiusura istantanea



20-354-32	32 x 52 mm
20-354-37	37 x 52 mm
20-354-43	43 x 52 mm
20-354-47	47 x 52 mm
20-354-52	52 x 52 mm
20-354-57	57 x 52 mm
20-354-62	62 x 52 mm
20-354-67	67 x 52 mm
20-354-70	70 x 52 mm



max. Spreizweite 90 mm
 max. spread 90 mm
 apertura máxima 90 mm
 apertura massima 90 mm

Transversal zu verwenden
 To be used for transverse retraction
 Útil para retracción transversal
 Da impiegarsi per trazioni trasversali

CASPAR

20-355-00 SET



Wundspreizer mit Gelenkarmen und Kugelschnellverschluß, komplett, bestehend aus:

1 Rahmen	20-355-01
1 Mediale Valve 40x23mm	20-358-01
1 Mediale Valve 45x23mm	20-358-02
1 Mediale Valve 50x23mm	20-358-03
1 Mediale Valve 55x23mm	20-358-04
1 Mediale Valve 60x23mm	20-358-05
1 Laterale Valve 40x23mm	20-358-11
1 Laterale Valve 45x23mm	20-358-12
1 Laterale Valve 50x23mm	20-358-13
1 Laterale Valve 55x23mm	20-358-14
1 Laterale Valve 60x23mm	20-358-15

Self-retaining retractor with hinged arms and ball snap closure, complete, consisting of:

1 Frame	20-355-01
1 Medial valve 40x23mm	20-358-01
1 Medial valve 45x23mm	20-358-02
1 Medial valve 50x23mm	20-358-03
1 Medial valve 55x23mm	20-358-04
1 Medial valve 60x23mm	20-358-05
1 Lateral valve 40x23mm	20-358-11
1 Lateral valve 45x23mm	20-358-12
1 Lateral valve 50x23mm	20-358-13
1 Lateral valve 55x23mm	20-358-14
1 Lateral valve 60x23mm	20-358-15

Separador con brazos articulados y cierre rápido esférico, completo, compuesto de:

1 Cuadro	20-355-01
1 Valva mediana 40x23mm	20-358-01
1 Valva mediana 45x23mm	20-358-02
1 Valva mediana 50x23mm	20-358-03
1 Valva mediana 55x23mm	20-358-04
1 Valva mediana 60x23mm	20-358-05
1 Valva lateral 40x23mm	20-358-11
1 Valva lateral 45x23mm	20-358-12
1 Valva lateral 50x23mm	20-358-13
1 Valva lateral 55x23mm	20-358-14
1 Valva lateral 60x23mm	20-358-15

Divaricatore con braccio articolato a chiusura istantanea, completo, composto da:

1 Telaio	20-355-01
1 Valva media 40x23mm	20-358-01
1 Valva media 45x23mm	20-358-02
1 Valva media 50x23mm	20-358-03
1 Valva media 55x23mm	20-358-04
1 Valva media 60x23mm	20-358-05
1 Valva laterale 40x23mm	20-358-11
1 Valva laterale 45x23mm	20-358-12
1 Valva laterale 50x23mm	20-358-13
1 Valva laterale 55x23mm	20-358-14
1 Valva laterale 60x23mm	20-358-15



20-358-14

20-358-15

55 x 23 mm

60 x 23 mm



20-358-01

20-358-02

20-358-03

20-358-04

20-358-05

20-358-11

20-358-12

20-358-13

40 x 23 mm

45 x 23 mm

50 x 23 mm

55 x 23 mm

60 x 23 mm

40 x 23 mm

45 x 23 mm

50 x 23 mm



max. Spreizweite 85 mm
 max. spread 85 mm
 apertura máxima 85 mm
 apertura massima 85 mm

In Wirbelsäulen-Längsachse zu verwenden
 To be used for outer line retraction
 Útil para el eje longitudinal de la columna vertebra
 Da impiegarsi per la trazioni e la compressione della colonna

CASPAR

20-356-00 SET



Wundspreizer mit Gelenkarmen und Kugelschnellverschluß, komplett, bestehend aus:

1 Rahmen	20-356-01
1 Stumpfe Valve 45x23mm	20-358-21
1 Stumpfe Valve 50x23mm	20-358-22
1 Stumpfe Valve 55x23mm	20-358-23
1 Stumpfe Valve 60x23mm	20-358-24
1 Stumpfe Valve 65x23mm	20-358-25

Self-retaining retractor with hinged arms and ball snap closure, complete, consisting of:

1 Frame	20-356-01
1 Blunt valve 45x23mm	20-358-21
1 Blunt valve 50x23mm	20-358-22
1 Blunt valve 55x23mm	20-358-23
1 Blunt valve 60x23mm	20-358-24
1 Blunt valve 65x23mm	20-358-25

Separador con brazos articulados y cierre rápido esférico, completo, compuesto de:

1 Cuadro	20-356-01
1 Valva roma 45x23mm	20-358-21
1 Valva roma 50x23mm	20-358-22
1 Valva roma 55x23mm	20-358-23
1 Valva roma 60x23mm	20-358-24
1 Valva roma 65x23mm	20-358-25

Divaricatore con braccio articolato a chiusura istantanea, completo, composto da:

1 Telaio	20-356-01
1 Valva smussa 45x23mm	20-358-21
1 Valva smussa 50x23mm	20-358-22
1 Valva smussa 55x23mm	20-358-23
1 Valva smussa 60x23mm	20-358-24
1 Valva smussa 65x23mm	20-358-25



20-358-21

45 x 23 mm

20-358-22

50 x 23 mm

20-358-23

55 x 23 mm

20-358-24

60 x 23 mm

20-358-25

65 x 23 mm



max. Spreizweite 90 mm
max. spread 90 mm
apertura máxima 90 mm
apertura massima 90 mm

In Wirbelsäulen-Längsachse zu verwenden
To be used for outer line retraction
Util para el eje longitudinal de la columna vertebra
Da impiegarsi per la trazioni e la compressione della colonna

CASPAR

20-357-00 SET



Wundspreizer mit Gelenkarmen und Kugelschnellverschluss, komplett, bestehend aus:

1 Rahmen	20-357-01
1 Stumpfe Valve 45x23mm	20-358-21
1 Stumpfe Valve 50x23mm	20-358-22
1 Stumpfe Valve 55x23mm	20-358-23
1 Stumpfe Valve 60x23mm	20-358-24
1 Stumpfe Valve 65x23mm	20-358-25

Self-retaining retractor with hinged arms and ball snap closure, complete, consisting of:

1 Frame	20-357-01
1 Blunt valve 45x23mm	20-358-21
1 Blunt valve 50x23mm	20-358-22
1 Blunt valve 55x23mm	20-358-23
1 Blunt valve 60x23mm	20-358-24
1 Blunt valve 65x23mm	20-358-25

Separador con brazos articulados y cierre rápido esférico, completo, compuesto de:

1 Cuadro	20-357-01
1 Valva roma 45x23mm	20-358-21
1 Valva roma 50x23mm	20-358-22
1 Valva roma 55x23mm	20-358-23
1 Valva roma 60x23mm	20-358-24
1 Valva roma 65x23mm	20-358-25

Divaricatore con braccio articolato a chiusura istantanea, completo, composto da:

1 Telaio	20-357-01
1 Valva smussa 45x23mm	20-358-21
1 Valva smussa 50x23mm	20-358-22
1 Valva smussa 55x23mm	20-358-23
1 Valva smussa 60x23mm	20-358-24
1 Valva smussa 65x23mm	20-358-25



20-358-21

45 x 23 mm

20-358-22

50 x 23 mm

20-358-23

55 x 23 mm

20-358-24

60 x 23 mm

20-358-25

65 x 23 mm



CCR

20-358-00 SET



Cervikales Wirbelsäulen Retraktor Set,
 bestehend aus:

1 Draht-Siebschale	55-191-07
1 Silikon Nopenmatte	55-855-00
1 OP Tuch	55-890-09
1 Kennzeichnungsschild	55-820-04
1 Cervikal Sperrer	20-355-01
1 Cervikal Sperrer	20-356-01
1 Cervikal Gegensperrer	20-357-01
10 Stumpfe Valven, TITAN	20-358-71 T - 20-358-80 T
10 Mediale Valven, TITAN	20-358-51 T - 20-358-60 T
10 Laterale Valven, TITAN	20-358-61 T - 20-358-70 T
1 Blätterwechselfinzette	20-358-99

Cervical spine retractor Set,
 consisting of:

1 Wire basket	55-191-07
1 Silicone mat	55-855-00
1 OT towel	55-890-09
1 Identification label	55-820-04
1 Cervical retractor	20-355-01
1 Cervical retractor	20-356-01
1 Cervical counter retr.	20-357-01
10 Blunt valves, TITANIUM	20-358-71 T - 20-358-80 T
10 Medial valves, TITANIUM	20-358-51 T - 20-358-60 T
10 Lateral valves, TITANIUM	20-358-61 T - 20-358-70 T
1 Valve changing forceps	20-358-99

Columna vertebral Separador Set,
 compuesto de:

1 Cesta de alambre	55-191-07
1 Soportes de silicona	55-855-00
1 Paño	55-890-09
1 Placa de identificación	55-820-04
1 Separador cervical	20-355-01
1 Separador cervical	20-356-01
1 Cervical contraseparador	20-357-01
10 Valvas romas, TITAN	20-358-71 T - 20-358-80 T
10 Valvas mediales, TITAN	20-358-51 T - 20-358-60 T
10 Valvas laterales, TITAN	20-358-61 T - 20-358-70 T
1 Pinza para valvas	20-358-99

Columna vertebral Separador Set,
 compuesto de:

1 Castello in rete metallica	55-191-07
1 Suppórtui in silicone	55-855-00
1 Tessuto	55-890-09
1 Targhette di identification	55-820-04
1 Cervical divaricatori	20-355-01
1 Cervical divaricatori	20-356-01
1 Cerv. contro divaricatori	20-357-01
10 Valve smusse, TITAN	20-358-71 T - 20-358-80 T
10 Valve medie, TITAN	20-358-51 T - 20-358-60 T
10 Valve laterali, TITAN	20-358-61 T - 20-358-70 T
1 Pinza per valve	20-358-99



max. Spreizweite 90 mm
max. spread 90 mm
apertura máxima 90 mm
apertura massima 90 mm

CASPAR

20-355-01



max. Spreizweite 90 mm
max. spread 90 mm
apertura máxima 90 mm
apertura massima 90 mm

CASPAR

20-355-01 T

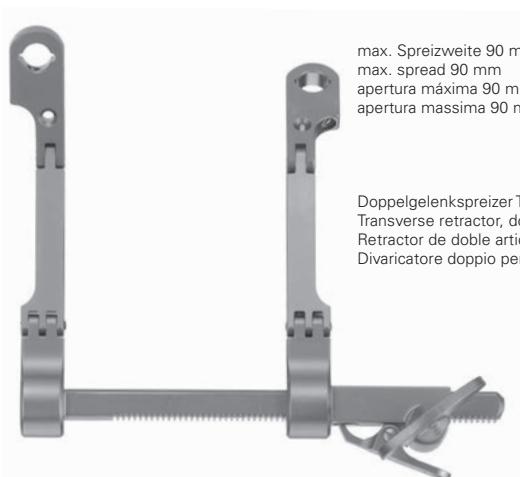

max. Spreizweite 90 mm
max. spread 90 mm
apertura máxima 90 mm
apertura massima 90 mm

Doppelgelenkspreizer Transversal
Transverse retractor, double hinged
Retractor de doble articulación, transversal
Divaricatore doppio per articolazione trasversale

CASPAR

20-355-10



max. Spreizweite 85 mm
max. spread 85 mm
apertura máxima 85 mm
apertura massima 85 mm

CASPAR

20-356-01





max. Spreizweite 90 mm
max. spread 90 mm
apertura máxima 90 mm
apertura massima 90 mm

CASPAR

20-357-01



max. Spreizweite 90 mm
max. spread 90 mm
apertura máxima 90 mm
apertura massima 90 mm

CASPAR

20-357-01 T



max. Spreizweite 90 mm
max. spread 90 mm
apertura máxima 90 mm
apertura massima 90 mm

Doppelgelenkspreizer Transversal
Transverse retractor, double hinged
Retractor de doble articulación, transversal
Divaricatore doppio per articolazione trasversale

CASPAR

20-357-10





Mediale Valven mit Kugelschnellverschluss
Medial valves with ball snap closure
Valvas mediales con cierre rápido esférico
Valve medie a chiusura istantanea



20-358-01	40 x 23 mm
20-358-02	45 x 23 mm
20-358-03	50 x 23 mm
20-358-04	55 x 23 mm
20-358-05	60 x 23 mm



Laterale Valven mit Kugelschnellverschluss
Lateral valves with ball snap closure
Valvas laterales con cierre rápido esférico
Valve laterali a chiusura istantanea



20-358-11	40 x 23 mm
20-358-12	45 x 23 mm
20-358-13	50 x 23 mm
20-358-14	55 x 23 mm
20-358-15	60 x 23 mm



Stumpfe Valven mit Kugelschnellverschluss
Blunt valves with ball snap closure
Valvas romas con cierre rápido esférico
Valve smusse a chiusura istantanea



20-358-21	45 x 23 mm
20-358-22	50 x 23 mm
20-358-23	55 x 23 mm
20-358-24	60 x 23 mm
20-358-25	65 x 23 mm



Stumpfe Valven mit Kugelschnellverschluss
Blunt valves with ball snap closure
Valvas romas con cierre rápido esférico
Valve smusse a chiusura istantanea



20-358-31	50 x 25 mm
20-358-32	60 x 25 mm



Mediale Valven mit Kugelschnellverschluss
Medial valves with ball snap closure
Valvas mediales con cierre rápido esférico
Valve medie a chiusura istantanea



20-358-51 T	25 x 24 mm
20-358-52 T	30 x 24 mm
20-358-53 T	35 x 24 mm
20-358-54 T	40 x 24 mm
20-358-55 T	45 x 24 mm
20-358-56 T	50 x 24 mm
20-358-57 T	55 x 24 mm
20-358-58 T	60 x 24 mm
20-358-59 T	65 x 24 mm
20-358-60 T	70 x 24 mm



Laterale Valven mit Kugelschnellverschluss
Lateral valves with ball snap closure
Valvas laterales con cierre rápido esférico
Valve laterali a chiusura istantanea



20-358-61 T	25 x 24 mm
20-358-62 T	30 x 24 mm
20-358-63 T	35 x 24 mm
20-358-64 T	40 x 24 mm
20-358-65 T	45 x 24 mm
20-358-66 T	50 x 24 mm
20-358-67 T	55 x 24 mm
20-358-68 T	60 x 24 mm
20-358-69 T	65 x 24 mm
20-358-70 T	70 x 24 mm



Stumpfe Valven mit Kugelschnellverschluss
Blunt valves with ball snap closure
Valvas romas con cierre rápido esférico
Valve smusse a chiusura istantanea



20-358-71 T	30 x 24 mm
20-358-72 T	35 x 24 mm
20-358-73 T	40 x 24 mm
20-358-74 T	45 x 24 mm
20-358-75 T	50 x 24 mm
20-358-76 T	55 x 24 mm
20-358-77 T	60 x 24 mm
20-358-78 T	65 x 24 mm
20-358-79 T	70 x 24 mm
20-358-80 T	75 x 24 mm



Mediale Valven mit Kugelschnellverschluss
 Medial valves with ball snap closure
 Valvas mediales con cierre rápido esférico
 Valve medie a chiusura istantanea



20-358-51 ST	25 x 25 mm
20-358-52 ST	30 x 25 mm
20-358-53 ST	35 x 25 mm
20-358-54 ST	40 x 25 mm
20-358-55 ST	45 x 25 mm
20-358-56 ST	50 x 25 mm
20-358-57 ST	55 x 25 mm
20-358-58 ST	60 x 25 mm
20-358-59 ST	65 x 25 mm
20-358-60 ST	70 x 25 mm



Laterale Valven mit Kugelschnellverschluss
 Lateral valves with ball snap closure
 Valvas laterales con cierre rápido esférico
 Valve laterali a chiusura istantanea



20-358-61 ST	25 x 25 mm
20-358-62 ST	30 x 25 mm
20-358-63 ST	35 x 25 mm
20-358-64 ST	40 x 25 mm
20-358-65 ST	45 x 25 mm
20-358-66 ST	50 x 25 mm
20-358-67 ST	55 x 25 mm
20-358-68 ST	60 x 25 mm
20-358-69 ST	65 x 25 mm
20-358-70 ST	70 x 25 mm



Pinzette zum Valvenwechsel bei Kugel-
 schnellverschluss-System
 Forceps for changing the valves with ball
 snap closure system
 Pinza para el cambio de valvas con el
 sistema de cierre rápido esférico
 Pinza per il cambio delle valve a chiusura
 istantanea



20-358-99 11,5 cm, 4 ½ "

Maßangaben für Blattgrößen
 Dimensions for blade sizes
 Datos sobre las dimensiones de cada tamaño de hoja
 Indicazioni sulle misure delle valve



20-358-14 55 x 23 mm

Valven mit Kugelschnellverschluss für Wundspreizer:
 Valves with ball snap closure for self retaining retractors:
 Valvas con cierre rápido esférico para seperadores:
 Valve a chiusura istantanea per divaricatori:

20-350-01
 20-355-01
 20-355-01 T
 20-355-10
 20-356-01
 20-357-01
 20-357-01 T
 20-357-10





max. Spreizweite 90 mm
max. spread 90 mm
apertura máxima 90 mm
apertura massima 90 mm



CASPAR

20-355-01 P



max. Spreizweite 90 mm
max. spread 90 mm
apertura máxima 90 mm
apertura massima 90 mm

Doppelgelenkspreizer Transversal
Transverse retractor, double hinged
Retractor de doble articulación, transversal
Divaricatore doppio per articolazione trasversale



CASPAR

20-355-10 P



max. Spreizweite 90 mm
max. spread 90 mm
apertura máxima 90 mm
apertura massima 90 mm



CASPAR

20-357-01 P



max. Spreizweite 90 mm
max. spread 90 mm
apertura máxima 90 mm
apertura massima 90 mm

Doppelgelenkspreizer Transversal
Transverse retractor, double hinged
Retractor de doble articulación, transversal
Divaricatore doppio per articolazione trasversale



CASPAR

20-357-10 P





max. Spreizweite 85 mm
 max. spread 85 mm
 apertura máxima 85 mm
 apertura massima 85 mm

CASPAR

20-356-01 P



PK
PEEK

STEEL
STAINLESS



Handgriff für Valven
 Handle for valves
 Asa para valvas
 Impugnatura per valvola

20-358-98 P



PK
PEEK



Mediale Valven mit Kugelschnellverschluss
 Medial valves with ball snap closure
 Valvas mediales con cierre rápido esférico
 Valve medie a chiusura istantanea



Laterale Valven mit Kugelschnellverschluss
 Lateral valves with ball snap closure
 Valvas laterales con cierre rápido esférico
 Valve laterali a chiusura istantanea



Laterale Valven mit Kugelschnellverschluss
 Lateral valves with ball snap closure
 Valvas laterales con cierre rápido esférico
 Valve laterali a chiusura istantanea



Stumpfe Valven mit Kugelschnellverschluss
 Blunt valves with ball snap closure
 Valvas romas con cierre rápido esférico
 Valve smusse a chiusura istantanea



PK
PEEK



PK
PEEK



PK
PEEK



PK
PEEK

20-358-01 P 40 x 23 mm

20-358-02 P 45 x 23 mm

20-358-03 P 50 x 23 mm

20-358-04 P 55 x 23 mm

20-358-05 P 60 x 23 mm

20-358-06 P 65 x 23 mm

20-358-08 P 75 x 23 mm

20-358-11 P 40 x 23 mm

20-358-12 P 45 x 23 mm

20-358-13 P 50 x 23 mm

20-358-14 P 55 x 23 mm

20-358-15 P 60 x 23 mm

20-358-16 P 65 x 23 mm

20-358-18 P 75 x 23 mm

20-358-41 P 40 x 12 mm

20-358-42 P 45 x 12 mm

20-358-43 P 50 x 12 mm

20-358-44 P 55 x 12 mm

20-358-45 P 60 x 12 mm

20-358-21 P 40 x 23 mm

20-358-22 P 45 x 23 mm

20-358-23 P 50 x 23 mm

20-358-24 P 55 x 23 mm

20-358-25 P 60 x 23 mm

20-358-26 P 65 x 23 mm

20-358-28 P 75 x 23 mm

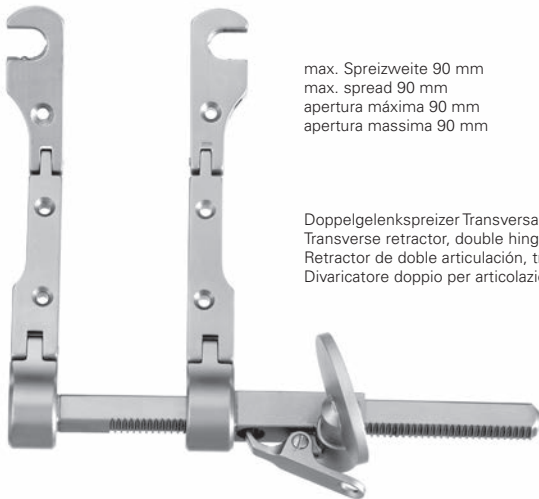

max. Spreizweite 90 mm
max. spread 90 mm
apertura máxima 90 mm
apertura massima 90 mm

Doppelgelenkspreizer Transversal
Transverse retractor, double hinged
Retractor de doble articulación, transversal
Divaricatore doppio per articolazione trasversale

CASPAR-QC

20-355-10 QC



max. Spreizweite 85 mm
max. spread 85 mm
apertura máxima 85 mm
apertura massima 85 mm

CASPAR-QC

20-356-01 QC



max. Spreizweite 90 mm
max. spread 90 mm
apertura máxima 90 mm
apertura massima 90 mm

Doppelgelenkspreizer Transversal
Transverse retractor, double hinged
Retractor de doble articulación, transversal
Divaricatore doppio per articolazione trasversale

CASPAR-QC

20-357-10 QC



Einsetzinstrument für QC Valven
QC valve inserter
Introduccion para valvas QC
Strumenti per inserzione di valve QC

CASPAR-QC

20-357-60 QC 18,5 cm, 7 "





Mediale Valven mit QC-Verschluss
 Medial valves with QC-closure
 Valvas mediales con cierre QC
 Valve medie a chiusura QC



QC

20-359-31 T	25 x 19 mm
20-359-32 T	30 x 19 mm
20-359-33 T	35 x 19 mm
20-359-34 T	40 x 19 mm
20-359-35 T	45 x 19 mm
20-359-36 T	50 x 19 mm
20-359-37 T	55 x 19 mm
20-359-38 T	60 x 19 mm

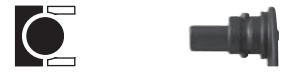

Stumpfe Valven mit QC-Verschluss
 Blunt valves with QC-closure
 Valvas romas con cierre QC
 Valve smusse a chiusura QC



QC

20-359-41 T	25 x 19 mm
20-359-42 T	30 x 19 mm
20-359-43 T	35 x 19 mm
20-359-44 T	40 x 19 mm
20-359-45 T	45 x 19 mm
20-359-46 T	50 x 19 mm
20-359-47 T	55 x 19 mm
20-359-48 T	60 x 19 mm



Mediale Valven mit QC-Verschluss
 Medial valves with QC-closure
 Valvas mediales con cierre QC
 Valve medie a chiusura QC



QC

20-359-51 T	30 x 24 mm
20-359-52 T	35 x 24 mm
20-359-53 T	40 x 24 mm
20-359-54 T	45 x 24 mm
20-359-55 T	50 x 24 mm
20-359-56 T	55 x 24 mm
20-359-57 T	60 x 24 mm
20-359-58 T	65 x 24 mm
20-359-59 T	70 x 24 mm



Laterale Valven mit QC-Verschluss
 Lateral valves with QC-closure
 Valvas laterales con cierre QC
 Valve laterali a chiusura QC



QC

20-359-61 T	30 x 24 mm
20-359-62 T	35 x 24 mm
20-359-63 T	40 x 24 mm
20-359-64 T	45 x 24 mm
20-359-65 T	50 x 24 mm
20-359-66 T	55 x 24 mm
20-359-67 T	60 x 24 mm
20-359-68 T	65 x 24 mm
20-359-69 T	70 x 24 mm



Stumpfe Valven mit QC-Verschluss
 Blunt valves with QC-closure
 Valvas romas con cierre QC
 Valve smusse a chiusura QC



QC

20-359-71 T	30 x 24 mm
20-359-72 T	35 x 24 mm
20-359-73 T	40 x 24 mm
20-359-74 T	45 x 24 mm
20-359-75 T	50 x 24 mm
20-359-76 T	55 x 24 mm
20-359-77 T	60 x 24 mm
20-359-78 T	65 x 24 mm
20-359-79 T	70 x 24 mm



max. Spreizweite 80 mm
max. spread 80 mm
apertura máxima 80 mm
apertura massima 80 mm

CLOWARD

20-360-00 SET



Wundspreizer, komplett,
bestehend aus:

1 Sperrer	20-360-01
1 Seitenvalve 40 mm	20-362-02
1 Seitenvalve 45 mm	20-362-03
1 Seitenvalve 50 mm	20-362-04
1 Seitenvalve 55 mm	20-362-05
1 Seitenvalve 60 mm	20-362-06

Self-retaining retractor,
complete, consisting of:

1 Spreader	20-360-01
1 Lateral valve 40 mm	20-362-02
1 Lateral valve 45 mm	20-362-03
1 Lateral valve 50 mm	20-362-04
1 Lateral valve 55 mm	20-362-05
1 Lateral valve 60 mm	20-362-06

Separador, completo,
compuesto de:

1 Separador	20-360-01
1 Valva lateral 40 mm	20-362-02
1 Valva lateral 45 mm	20-362-03
1 Valva lateral 50 mm	20-362-04
1 Valva lateral 55 mm	20-362-05
1 Valva lateral 60 mm	20-362-06

Divaricatore, completo,
composto da:

1 Divaricatore	20-360-01
1 Valva laterale 40 mm	20-362-02
1 Valva laterale 45 mm	20-362-03
1 Valva laterale 50 mm	20-362-04
1 Valva laterale 55 mm	20-362-05
1 Valva laterale 60 mm	20-362-06



Pinzette zum Valvenwechsel bei Kugel-
schnellverschluß-System

Forceps for changing valves with ball snap
closure system

Pinza para el cambio de valvas con el
sistema de cierre rápido esférico

Pinza per il cambio delle valve a chiusura
istantanea



20-362-02

40 mm

20-362-03

45 mm

20-362-04

50 mm

20-362-05

55 mm

20-362-06

60 mm

20-358-99 11,5 cm, 4 1/2 "



max. Spreizweite 60 mm
 max. spread 60 mm
 apertura máxima 60 mm
 apertura massima 60 mm

CLOWARD

20-362-00 SET



Wundspreizer, komplett,
 bestehend aus:

1 Sperrer	20-362-01
1 Seitenvlve 40 mm	20-362-12
1 Seitenvlve 45 mm	20-362-13
1 Seitenvlve 50 mm	20-362-14
1 Seitenvlve 55 mm	20-362-15
1 Seitenvlve 60 mm	20-362-16

Self-retaining retractor,
 complete, consisting of:

1 Spreader	20-362-01
1 Lateral valve 40 mm	20-362-12
1 Lateral valve 45 mm	20-362-13
1 Lateral valve 50 mm	20-362-14
1 Lateral valve 55 mm	20-362-15
1 Lateral valve 60 mm	20-362-16

Separador, completo,
 compuesto de:

1 Separador	20-362-01
1 Valva lateral 40 mm	20-362-12
1 Valva lateral 45 mm	20-362-13
1 Valva lateral 50 mm	20-362-14
1 Valva lateral 55 mm	20-362-15
1 Valva lateral 60 mm	20-362-16

Divaricatore, completo,
 composto da:

1 Divaricatore	20-362-01
1 Valva laterale 40 mm	20-362-12
1 Valva laterale 45 mm	20-362-13
1 Valva laterale 50 mm	20-362-14
1 Valva laterale 55 mm	20-362-15
1 Valva laterale 60 mm	20-362-16



20-362-12

40 mm

20-362-13

45 mm

20-362-14

50 mm

20-362-15

55 mm

20-362-16

60 mm



Pinzette zum Valvenwechsel bei Kugel-
 schnellverschluß-System

Forceps for changing valves with ball snap
 closure system

Pinza para el cambio de valvas con el
 sistema de cierre rápido esférico

Pinza per il cambio delle valve a chiusura
 istantanea



20-358-99 11,5 cm, 4 1/2 "



CASPAR

20-365-00 SET



Wundspreizer, komplett, bestehend aus:	
1 Sperrer	20-365-01
1 Valve, gezahnt 40 mm	20-365-40
1 Valve, gezahnt 45 mm	20-365-45
1 Valve, gezahnt 50 mm	20-365-50
1 Valve, gezahnt 55 mm	20-365-55
1 Valve, gezahnt 60 mm	20-365-60
1 Valve, gezahnt 65 mm	20-365-65
1 Valve, gezahnt 70 mm	20-365-70

Self-retaining retractor, complete, consisting of:	
1 Spreader	20-365-01
1 Serrated valve 40 mm	20-365-40
1 Serrated valve 45 mm	20-365-45
1 Serrated valve 50 mm	20-365-50
1 Serrated valve 55 mm	20-365-55
1 Serrated valve 60 mm	20-365-60
1 Serrated valve 65 mm	20-365-65
1 Serrated valve 70 mm	20-365-70

Separador, completo, compuesto de:	
1 Separador	20-365-01
1 Valva dentada 40 mm	20-365-40
1 Valva dentada 45 mm	20-365-45
1 Valva dentada 50 mm	20-365-50
1 Valva dentada 55 mm	20-365-55
1 Valva dentada 60 mm	20-365-60
1 Valva dentada 65 mm	20-365-65
1 Valva dentada 70 mm	20-365-70

Divaricatore, completo, composto da:	
1 Divaricatore	20-365-01
1 Valva dentellata 40 mm	20-365-40
1 Valva dentellata 45 mm	20-365-45
1 Valva dentellata 50 mm	20-365-50
1 Valva dentellata 55 mm	20-365-55
1 Valva dentellata 60 mm	20-365-60
1 Valva dentellata 65 mm	20-365-65
1 Valva dentellata 70 mm	20-365-70



20-365-40 **20-365-45** **20-365-50** **20-365-55** **20-365-60** **20-365-65** **20-365-70**

40 mm 45 mm 50 mm 55 mm 60 mm 65 mm 70 mm





MLD

20-366-00 SET



Lumbales Mikrodisektomie Retraktor Set, bestehend aus:

2 Draht-Siebschalen	55-191-07
2 Silikon Nopenmatten	55-855-00
2 OPTücher	55-890-09
2 Kennzeichnungsschilder	55-820-04
6 Caspar Spekulas, 40 - 65 mm	20-366-40 - 20-366-65
1 Caspar Gegensperrer	20-367-01
7 Laterale Valven, 35 - 65 mm	20-367-02 - 20-367-08
1 Blätterwechselfinzette	20-358-99

Micro lumbar discectomy retractor Set, consisting of:

2 Wire baskets	55-191-07
2 Silicone mats	55-855-00
2 OT towels	55-890-09
2 Identification labels	55-820-04
6 Caspar speculas, 40 - 65 mm	20-366-40 - 20-366-65
1 Caspar counter retractor	20-367-01
7 Lateral valves, 35 - 65 mm	20-367-02 - 20-367-08
1 Valve changing forceps	20-358-99

Microdissectomía lumbar separador Set, compuesto de:

2 Cesta de alambre	55-191-07
2 Soportes de silicona	55-855-00
2 Paño	55-890-09
2 Placa de identificación	55-820-04
6 Caspar espéculos, 40 - 65 mm	20-366-40 - 20-366-65
1 Caspar contraseparador	20-367-01
7 Valvas lateral, 35 - 65 mm	20-367-02 - 20-367-08
1 Pinza para valvas	20-358-99

Lombare microdischectomia divaricatori Set, composto da:

2 Castello in rete metallica	55-191-07
2 Suppórtui in silicone	55-855-00
2 Tessuto	55-890-09
2 Targhette di identification	55-820-04
6 Caspar speculi, 40 - 65 mm	20-366-40 - 20-366-65
1 Caspar divaricatori	20-367-01
7 Valva laterale, 35 - 65 mm	20-367-02 - 20-367-08
1 Pinza per valve	20-358-99



max. Spreizweite 60 mm
max. spread 60 mm
apertura máxima 60 mm
apertura massima 60 mm

CASPAR

20-367-00 SET



Wundspreizer mit Gelenkarmen und Kugelschnellverschluß komplett, bestehend aus:

1 Rahmen	20-367-01
1 Seitenvalve, 35 mm	20-367-02
1 Seitenvalve, 40 mm	20-367-03
1 Seitenvalve, 45 mm	20-367-04
1 Seitenvalve, 50 mm	20-367-05
1 Seitenvalve, 55 mm	20-367-06
1 Seitenvalve, 60 mm	20-367-07

Self-retaining retractor with hinged arms and ball snap closure, complete, consisting of:

1 Frame	20-367-01
1 Lateral valve, 35 mm	20-367-02
1 Lateral valve, 40 mm	20-367-03
1 Lateral valve, 45 mm	20-367-04
1 Lateral valve, 50 mm	20-367-05
1 Lateral valve, 55 mm	20-367-06
1 Lateral valve, 60 mm	20-367-07

Separador con brazos articulados y cierre rápido esférico, completo compuesto de:

1 Separador	20-367-01
1 Valva lateral, 35 mm	20-367-02
1 Valva lateral, 40 mm	20-367-03
1 Valva lateral, 45 mm	20-367-04
1 Valva lateral, 50 mm	20-367-05
1 Valva lateral, 55 mm	20-367-06
1 Valva lateral, 60 mm	20-367-07

Divaricatore con braccio articolato a chiusura istantanea, completo, composto da:

1 Divaricatore	20-367-01
1 Valva laterale, 35 mm	20-367-02
1 Valva laterale, 40 mm	20-367-03
1 Valva laterale, 45 mm	20-367-04
1 Valva laterale, 50 mm	20-367-05
1 Valva laterale, 55 mm	20-367-06
1 Valva laterale, 60 mm	20-367-07



20-367-02

20-367-03

20-367-04

20-367-05

20-367-06

20-367-07

35 mm

40 mm

45 mm

50 mm

55 mm

60 mm





Laterale Valven mit Kugelschnellverschluss
 Lateral valves with ball snap closure
 Valvas laterales con cierre rápido esférico
 Valve laterali a chiusura istantanea



CASPAR

20-367-02	35 mm
20-367-03	40 mm
20-367-04	45 mm
20-367-05	50 mm
20-367-06	55 mm
20-367-07	60 mm
20-367-08	65 mm
20-367-09	75 mm
20-367-10	85 mm



Mediale Valven mit Kugelschnellverschluss
 Medial valves with ball snap closure
 Valvas mediales con cierre rápido esférico
 Valve medie a chiusura istantanea



CASPAR

20-367-13	40 mm
20-367-14	45 mm
20-367-15	50 mm
20-367-16	55 mm
20-367-17	60 mm
20-367-18	65 mm
20-367-19	70 mm



Pinzette zum Valvenwechsel bei Kugelschnellverschluss-System
 Forceps for changing valves with ball snap closure system
 Pinza para el cambio de valvas con el sistema de cierre rápido esférico
 Pinza per il cambio delle valve a chiusura istantanea



20-358-99 11,5 cm, 4 1/2"

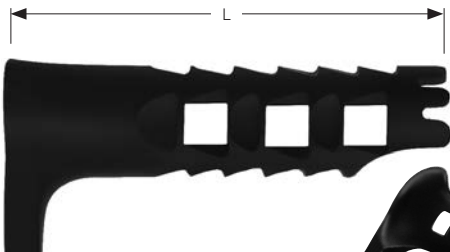

CASPAR

20-366-40	40 mm
20-366-45	45 mm
20-366-50	50 mm
20-366-55	55 mm
20-366-60	60 mm
20-366-65	65 mm
20-366-70	70 mm
20-366-75	75 mm
20-366-85	85 mm



STOTZ

20-366-01	40 mm
20-366-02	45 mm
20-366-03	50 mm
20-366-04	55 mm
20-366-05	60 mm
20-366-06	65 mm
20-366-07	70 mm
20-366-08	75 mm
20-366-09	85 mm

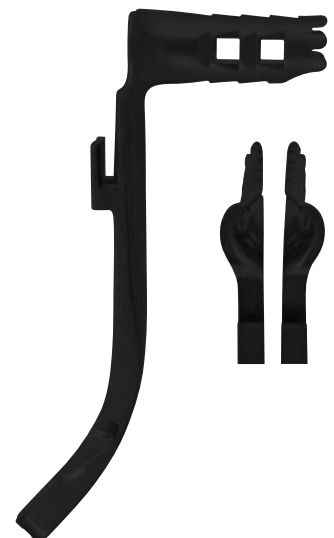



max. Spreizweite 70 | 90 mm
max. spread 70 | 90 mm
apertura máxima 70 | 90 mm
apertura massima 70 | 90 mm

MC CULLOCH

20-368-00	70 mm
20-368-02	90 mm



max. Spreizweite 67 mm
max. spread 67 mm
apertura máxima 67 mm
apertura massima 67 mm

MC CULLOCH

20-368-01	67 mm
------------------	-------



Muskelblätter, 4 Zinken, schmal
Muscle blades, 4 prongs, narrow
Valvas musculares, 4 dientes, estrechas
Valve muscolari, 4 punte, sottili



MC CULLOCH

20-368-03	30 x 20 mm
20-368-04	40 x 20 mm
20-368-05	50 x 20 mm
20-368-06	60 x 20 mm
20-368-07	70 x 20 mm
20-368-08	80 x 20 mm
20-368-09	90 x 20 mm
20-368-10	100 x 20 mm
20-368-11	120 x 20 mm

Muskelblätter, 6 Zinken, breit
Muscle blades, 6 prongs, wide
Valvas musculares, 6 dientes, anchas
Valve muscolari, 6 punte, larghe



MC CULLOCH

20-368-13	30 x 27 mm
20-368-14	40 x 27 mm
20-368-15	50 x 27 mm
20-368-16	60 x 27 mm
20-368-17	70 x 27 mm
20-368-18	80 x 27 mm
20-368-19	90 x 27 mm
20-368-20	100 x 27 mm

Muskelblätter, 2 Zinken, schmal
Muscle blades, 2 prongs, narrow
Valvas musculares, 2 dientes, estrechas
Valve muscolari, 2 punte, sottili



Cervikal Blätter, 2 Zinken
Cervical blades, 2 prongs
Valvas cervicales, 2 dientes
Valve cervicali, 2 punte



MC CULLOCH

20-368-23	30 x 27 mm
20-368-24	40 x 27 mm
20-368-25	50 x 27 mm
20-368-26	60 x 27 mm
20-368-27	70 x 27 mm
20-368-28	80 x 27 mm
20-368-29	90 x 27 mm

MC CULLOCH

20-368-35	50 x 20 mm
20-368-36	60 x 20 mm
20-368-37	70 x 20 mm

Hakenblätter
Hook blades
Valvas con gancho
Divaricatori a valve

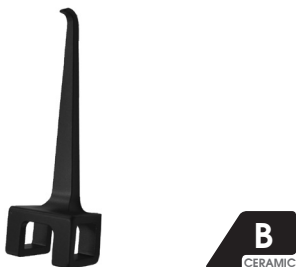

Hakenblätter, mehrfach gezahnt
Hook blades, multiple serrated
Valvas con gancho, dentado múltiple
Divaricatori a valve, dentato su diversi lati



MC CULLOCH

20-369-02	20 mm
20-369-03	30 mm
20-369-04	40 mm
20-369-05	50 mm
20-369-06	60 mm
20-369-07	70 mm
20-369-08	80 mm
20-369-09	90 mm

MC CULLOCH

20-369-12	20 mm
20-369-13	30 mm
20-369-14	40 mm
20-369-15	50 mm
20-369-16	60 mm
20-369-17	70 mm
20-369-18	80 mm
20-369-19	90 mm

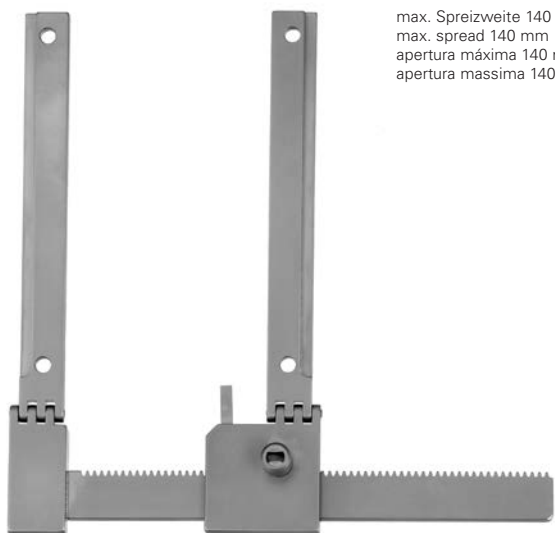

max. Spreizweite 140 mm
max. spread 140 mm
apertura máxima 140 mm
apertura massima 140 mm

KARLIN-CRANK

20-370-00 SET

Wundspreizer mit Gelenkarmen,
komplett, bestehend aus:

1 Rahmen	20-370-01
1 Schlüssel	20-370-05
1 Blatt, links, 31x38 mm	20-370-10
1 Blatt, rechts, 31x38 mm	20-370-11
1 Blatt, links, 57x44 mm	20-370-12
1 Blatt, rechts, 57x44 mm	20-370-13
2 Blätter, 76x64 mm	20-370-14

Self-retaining retractor with hinged
arms, complete, consisting of:

1 Frame	20-370-01
1 Key	20-370-05
1 Blade, left, 31x38 mm	20-370-10
1 Blade, right, 31x38 mm	20-370-11
1 Blade, left, 57x44 mm	20-370-12
1 Blade, right, 57x44 mm	20-370-13
2 Blades, 76x64 mm	20-370-14

Seperador con brazos articulados,
completo, compuesto de:

1 Cuadro	20-370-01
1 Llave	20-370-05
1 Valva, zurdo, 31x38mm	20-370-10
1 Valva, derecha, 31x38mm	20-370-11
1 Valva, zurdo, 57x44mm	20-370-12
1 Valva, derecha, 57x44mm	20-370-13
1 Valva, 76x64mm	20-370-14

Divaricatore con braccio articolato,
completo, composto da:

1 Telaio	20-370-01
1 Chiave	20-370-05
1 Valva, sinistra, 37x22 mm	20-370-10
1 Valva, destra, 37x22 mm	20-370-11
1 Valva, sinistra, 57x44 mm	20-370-12
1 Valva, destra, 57x44 mm	20-370-13
1 Valva, 76x64 mm	20-370-14



20-370-10

31 x 38 mm



20-370-11

31 x 38 mm



20-370-12

57 x 44 mm



20-370-13

57 x 44 mm

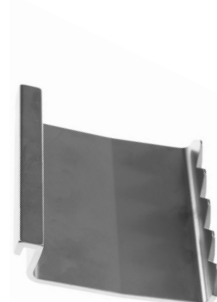

20-370-14

76 x 64 mm

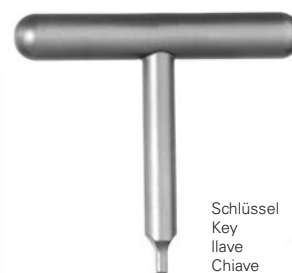

Schlüssel
Key
llave
Chiave

20-370-05

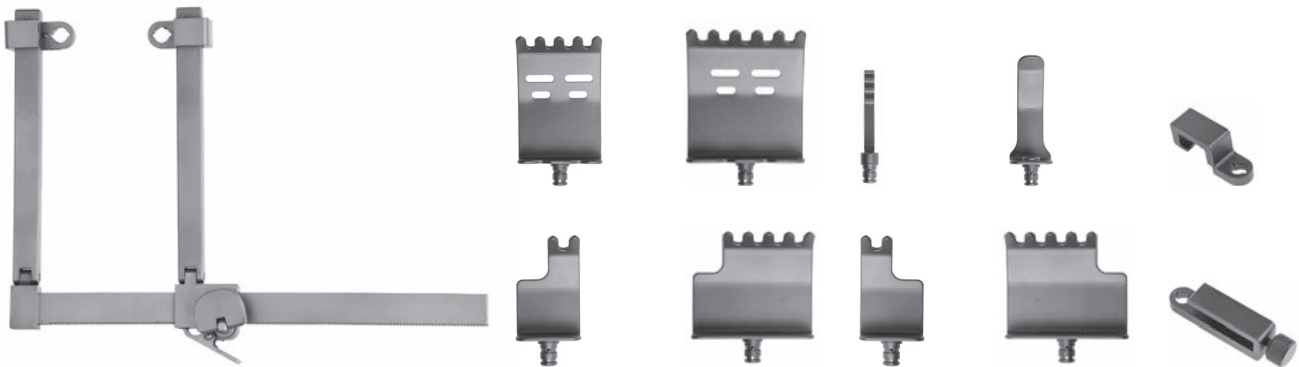

SPREADY

20-370-30 T SET



Wundspreizer mit Gelenkarmen,
komplett, bestehend aus:

1 Rahmen	20-370-32 T
2 L. Blatt, 46 x 45 mm	20-370-52 T
2 L. Blatt, 56 x 45 mm	20-370-53 T
2 L. Blatt, 66 x 45 mm	20-370-54 T
2 L. Blatt, 76 x 45 mm	20-370-55 T
2 L. Blatt, 46 x 60 mm	20-370-62 T
2 L. Blatt, 56 x 60 mm	20-370-63 T
2 L. Blatt, 66 x 60 mm	20-370-64 T
2 L. Blatt, 76 x 60 mm	20-370-65 T
2 L. Haken Blatt, 42 mm	20-370-72 T
2 L. Haken Blatt, 52 mm	20-370-73 T
2 L. Haken Blatt, 62 mm	20-370-74 T
2 L. Haken Blatt, 72 mm	20-370-75 T
1 Blatt V1, 36 x 30 mm	20-370-91 T
1 Blatt V2, 36 x 30 mm	20-370-93 T
1 Blatt V1, 41 x 60 mm	20-370-92 T
1 Blatt V2, 41 x 60 mm	20-370-94 T
2 Aufnahmen, justierbar	20-370-35 T
1 Aufnahme, Verschluß	20-370-36 T

Self-retaining retractor with hinged
arms, complete, consisting of:

1 Frame	20-370-32 T
2 L. blade, 46 x 45 mm	20-370-52 T
2 L. blade, 56 x 45 mm	20-370-53 T
2 L. blade, 66 x 45 mm	20-370-54 T
2 L. blade, 76 x 45 mm	20-370-55 T
2 L. blade, 46 x 60 mm	20-370-62 T
2 L. blade, 56 x 60 mm	20-370-63 T
2 L. blade, 66 x 60 mm	20-370-64 T
2 L. blade, 76 x 60 mm	20-370-65 T
2 L. hook blade, 42 mm	20-370-72 T
2 L. hook blade, 52 mm	20-370-73 T
2 L. hook blade, 62 mm	20-370-74 T
2 L. hook blade, 72 mm	20-370-75 T
1 Blade V1, 36 x 30 mm	20-370-91 T
1 Blade V2, 36 x 30 mm	20-370-93 T
1 Blade V1, 41 x 60 mm	20-370-92 T
1 Blade V2, 41 x 60 mm	20-370-94 T
2 Adapters, adjustable	20-370-35 T
1 Adapter, w. closure	20-370-36 T

Seperador con brazos articulados,
completo, compuesto de:

1 Cuadro	20-370-32 T
2 L. valva, 46 x 45 mm	20-370-52 T
2 L. valva, 56 x 45 mm	20-370-53 T
2 L. valva, 66 x 45 mm	20-370-54 T
2 L. valva, 76 x 45 mm	20-370-55 T
2 L. valva, 46 x 60 mm	20-370-62 T
2 L. valva, 56 x 60 mm	20-370-63 T
2 L. valva, 66 x 60 mm	20-370-64 T
2 L. valva, 76 x 60 mm	20-370-65 T
2 L. valva gancho 42 mm	20-370-72 T
2 L. valva gancho 52 mm	20-370-73 T
2 L. valva gancho 62 mm	20-370-74 T
2 L. valva gancho 72 mm	20-370-75 T
1 Valva V1, 36 x 30 mm	20-370-91 T
1 Valva V2, 36 x 30 mm	20-370-93 T
1 Valva V1, 41 x 60 mm	20-370-92 T
1 Valva V2, 41 x 60 mm	20-370-94 T
2 Soporte de valvas	20-370-35 T
1 Soporte de valvas	20-370-36 T

Divaricatore con braccio articolato,
completo, composto da:

1 Telaio	20-370-32 T
2 L. valva, 46 x 45 mm	20-370-52 T
2 L. valva, 56 x 45 mm	20-370-53 T
2 L. valva, 66 x 45 mm	20-370-54 T
2 L. valva, 76 x 45 mm	20-370-55 T
2 L. valva, 46 x 60 mm	20-370-62 T
2 L. valva, 56 x 60 mm	20-370-63 T
2 L. valva, 66 x 60 mm	20-370-64 T
2 L. valva, 76 x 60 mm	20-370-65 T
2 L. Divari. valva, 42 mm	20-370-72 T
2 L. Divari. valva, 52 mm	20-370-73 T
2 L. Divari. valva, 62 mm	20-370-74 T
2 L. Divari. valva, 72 mm	20-370-75 T
1 Valva V1, 36 x 30 mm	20-370-91 T
1 Valva V2, 36 x 30 mm	20-370-93 T
1 Valva V1, 41 x 60 mm	20-370-92 T
1 Valva V2, 41 x 60 mm	20-370-94 T
2 Supporto valva	20-370-35 T
1 Supporto valva	20-370-36 T

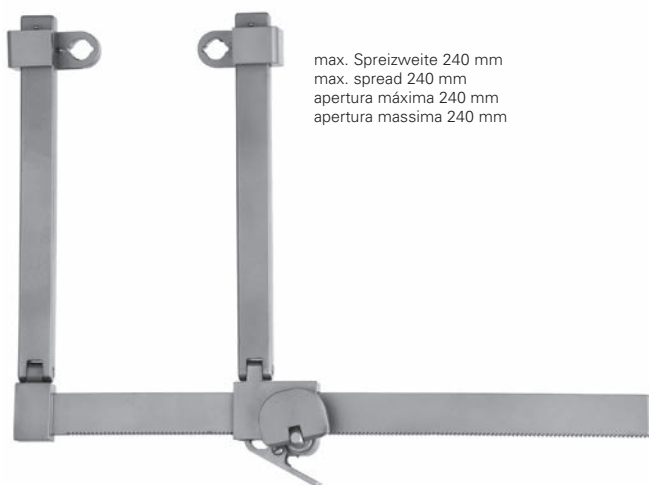

max. Spreizweite 240 mm
max. spread 240 mm
apertura máxima 240 mm
apertura massima 240 mm

SPREADY

20-370-32 T

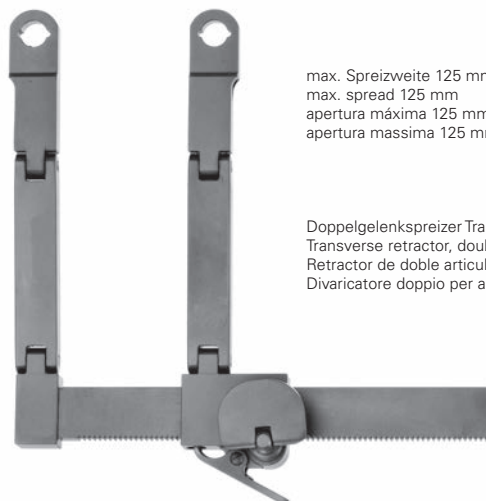

max. Spreizweite 125 mm
max. spread 125 mm
apertura máxima 125 mm
apertura massima 125 mm

Doppelgelenkspreizer Transversal
Transverse retractor, double hinged
Retractor de doble articulación, transversal
Divaricatore doppio per articolazione trasversale

SPREADY

20-370-33 T



Lumbal Blätter, 3 Zinken mit Kugelschnellverschluss
Lumbar blades, 3 prongs with ball snap closure
Valvas lumbares, 3 dientes con cierre rápido esférico
Valve lombari, 3 punte a chiusura istantanea



SPREADY

20-370-40 T	30 x 20 mm
20-370-41 T	35 x 20 mm
20-370-42 T	40 x 20 mm
20-370-43 T	50 x 20 mm
20-370-44 T	60 x 20 mm
20-370-45 T	70 x 20 mm
20-370-46 T	80 x 20 mm
20-370-47 T	90 x 20 mm
20-370-48 T	100 x 20 mm
20-370-49 T	110 x 20 mm



Lumbal Blätter, 5 Zinken mit Kugelschnellverschluss
Lumbar blades, 5 prongs with ball snap closure
Valvas lumbares, 5 dientes con cierre rápido esférico
Valve lombari, 5 punte a chiusura istantanea



SPREADY

20-370-52 T	46 x 45 mm
20-370-53 T	56 x 45 mm
20-370-54 T	66 x 45 mm
20-370-55 T	76 x 45 mm



Lumbal Blätter, 6 Zinken mit Kugelschnellverschluss
Lumbar blades, 6 prongs with ball snap closure
Valvas lumbares, 6 dientes con cierre rápido esférico
Valve lombari, 6 punte a chiusura istantanea



SPREADY

20-370-62 T	46 x 60 mm
20-370-63 T	56 x 60 mm
20-370-64 T	66 x 60 mm
20-370-65 T	76 x 60 mm



Lumbale Hakenblätter mit Kugelschnellverschluss
 Lumbar hook blades with ball snap closure
 Valvas con gancho lumbares con cierre rápido esférico
 Divaricatori lombari a valve a chiusura istantanea



SPREADY

- 20-370-72 T** 42 x 6 mm
- 20-370-73 T** 52 x 6 mm
- 20-370-74 T** 62 x 6 mm
- 20-370-75 T** 72 x 6 mm



Stumpfe Blätter mit Kugelschnellverschluss
 Blunt blades with ball snap closure
 Valvas romas con cierre rápido esférico
 Valve smusse a chiusura istantanea



SPREADY

- 20-370-81 T** 30 x 15 mm
- 20-370-82 T** 40 x 15 mm
- 20-370-83 T** 50 x 15 mm
- 20-370-84 T** 60 x 15 mm
- 20-370-85 T** 70 x 15 mm

Blattaufnahme mit Verschuß
 Blade adapter with closure
 Soporte de valvas con cierre
 Supporto valva con chiusura



SPREADY

20-370-36 T

Blattaufnahme mit Rändelschraube, justierbar
 Blade adapter with knurled screw, adjustable
 Soporte de valvas con tornillo moleteado, ajustable
 Supporto valva con vite a testa zigrinata, regolabile



SPREADY

20-370-35 T



Sakral Lumbale Blätter mit Kugelschnellverschluss
 Sacral lumbar blades with ball snap closure
 Valvas lumbares sacras con cierre rápido esférico
 Divaricatori sacrali a valve a chiusura istantanea



SPREADY

20-370-91 T 36 x 30 mm



SPREADY

20-370-93 T 36 x 30 mm



SPREADY

20-370-94 T 41 x 60 mm



SPREADY

20-370-92 T 41 x 60 mm

max. Spreizweite 20 mm
max. spread 20 mm
apertura máxima 20 mm
apertura massima 20 mm



CLOWARD

20-371-13 13,5 cm, 5 1/4"

max. Spreizweite 15 mm
max. spread 15 mm
apertura máxima 15 mm
apertura massima 15 mm



CLOWARD

20-371-15 15,5 cm, 6 1/8"

max. Spreizweite 38 mm
max. spread 38 mm
apertura máxima 38 mm
apertura massima 38 mm



INGE

20-375-01 17,0 cm, 6 3/4"

max. Spreizweite 38 mm
max. spread 38 mm
apertura máxima 38 mm
apertura massima 38 mm



INGE

20-375-02 17,0 cm, 6 3/4"

max. Spreizweite 50 mm
max. spread 50 mm
apertura máxima 50 mm
apertura massima 50 mm



INGE

20-376-27 27,5 cm, 10 3/4"

max. Spreizweite 50 mm
max. spread 50 mm
apertura máxima 50 mm
apertura massima 50 mm



INGE

20-377-27 27,5 cm, 10 3/4"

Konkav
Concave
Côncavo
Concavo

max. Spreizweite 80 mm
 max. spread 80 mm
 apertura máxima 80 mm
 apertura massima 80 mm



CLOWARD

20-380-12 13,0 cm, 5 ¼"

max. Spreizweite 70 mm
 max. spread 70 mm
 apertura máxima 70 mm
 apertura massima 70 mm



CLOWARD

20-380-13 13,5 cm, 5 ¼"

max. Spreizweite 70 mm
 max. spread 70 mm
 apertura máxima 70 mm
 apertura massima 70 mm



CLOWARD

20-380-16 16,5 cm, 6 ¼"

max. Spreizweite 105 mm
 max. spread 105 mm
 apertura máxima 105 mm
 apertura massima 105 mm



KNIGHTON

20-381-19 19,0 cm, 7 ½"

max. Spreizweite 105 mm
 max. spread 105 mm
 apertura máxima 105 mm
 apertura massima 105 mm



KNIGHTON

20-382-19 19,0 cm, 7 ½"



20-450-40	40 x 10 mm
20-450-50	50 x 10 mm
20-450-60	60 x 10 mm
20-450-70	70 x 10 mm
20-451-50	50 x 20 mm
20-451-60	60 x 20 mm
20-451-70	70 x 20 mm

links
left
zurdo
sinistra

SCHUL

20-450-40 - 20-451-70 17,0 cm, 6 3/4"



20-452-40	40 x 10 mm
20-452-50	50 x 10 mm
20-452-60	60 x 10 mm
20-452-70	70 x 10 mm
20-453-50	50 x 20 mm
20-453-60	60 x 20 mm
20-453-70	70 x 20 mm

rechts
right
derecha
destra

SCHUL

20-452-40 - 20-453-70 17,0 cm, 6 3/4"



26



HNO-Instrumente

ENT Instruments

Instrumentos para ORL

Strumenti per ORL



26



Mikro Instrumente

Micro Instruments

Instrumentos de micro

Strumentario micro

Fordern Sie unser Spezialprospekt an
Please ask for our special catalogue
No duden pedirnos más catálogos especiales
Chiedete i nostri cataloghi speciali



72



Endoskope

Endoscopes

Endoscopios

Endoscopi

Fordern Sie unser Spezialprospekt an
Please ask for our special catalogue
No duden pedirnos más catálogos especiales
Chiedete i nostri cataloghi speciali



26-000-14 14,5 cm, 5 3/4"



26-002-14 14,0 cm, 5 1/2"

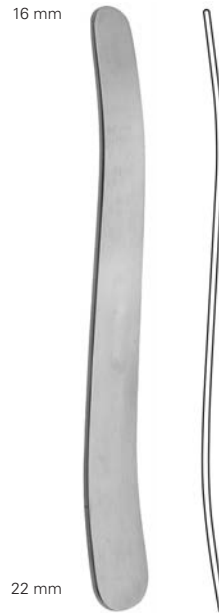

MAYO

26-004-16 17,0 cm, 6 3/4"



BUCHWALD

26-004-18 18,0 cm, 7"



BRUENINGS

26-006-19 19,0 cm, 7 1/2"



FRENZEL

26-007-16 16,5 cm, 6 1/2"



FRENZEL

26-008-14 14,5 cm, 5 3/4"



LACK

26-009-13	13,0 mm
26-009-19	19,0 mm
26-009-22	22,0 mm

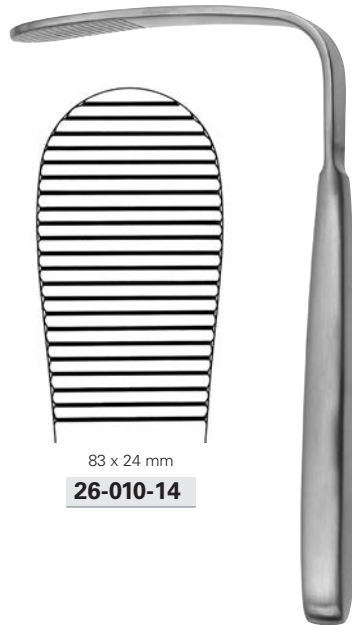

83 x 24 mm
26-010-14

TOBOLD

26-010-14	14,0 cm, 5 ½"
------------------	---------------



83 x 24 mm
26-010-15

TOBOLD

26-010-15	14,0 cm, 5 ½"
------------------	---------------

21 mm



MORITZ-SCHMIDT

26-010-19	19,0 cm, 7 ½"
------------------	---------------



72 x 23 mm
26-011-15

HARTMANN

26-011-15	15,0 cm, 6"
------------------	-------------

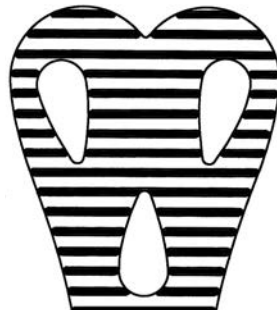

30 x 90 mm
26-017-01



35 x 90 mm
26-017-02

WIEDER

26-017-01 - 26-017-02 14,5 cm, 5 3/4"

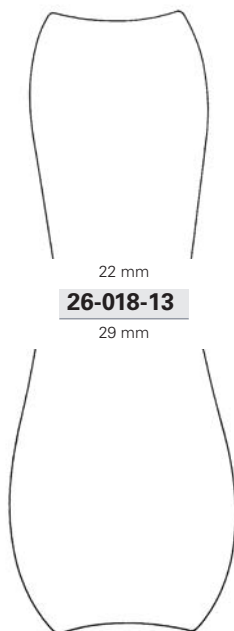

22 mm
26-018-13
29 mm

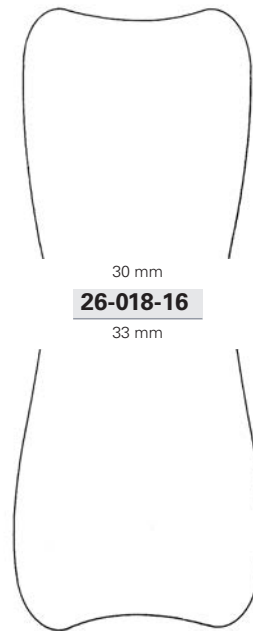

30 mm
26-018-16
33 mm

DOYEN

26-018-13 13,0 cm, 5 1/8"
26-018-16 16,0 cm, 6 1/4"



HEISTER

26-022-13 13,0 cm, 5 "



MOLT

26-023-10 10,0 cm, 4 "



DOYEN-COLLIN

26-025-12 12,0 cm, 4 ¾ "

26-028-99

Ersatzbacken
Spare jaws
Bocas de repuesto
Branche di ricambio



DOYEN-JANSEN

26-026-14 14,0 cm, 5 ½ "



FERGUSSON-ACKLAND

26-027-14 14,5 cm, 5 ¾ "



DENHARDT

26-028-12 12,5 cm, 5 "

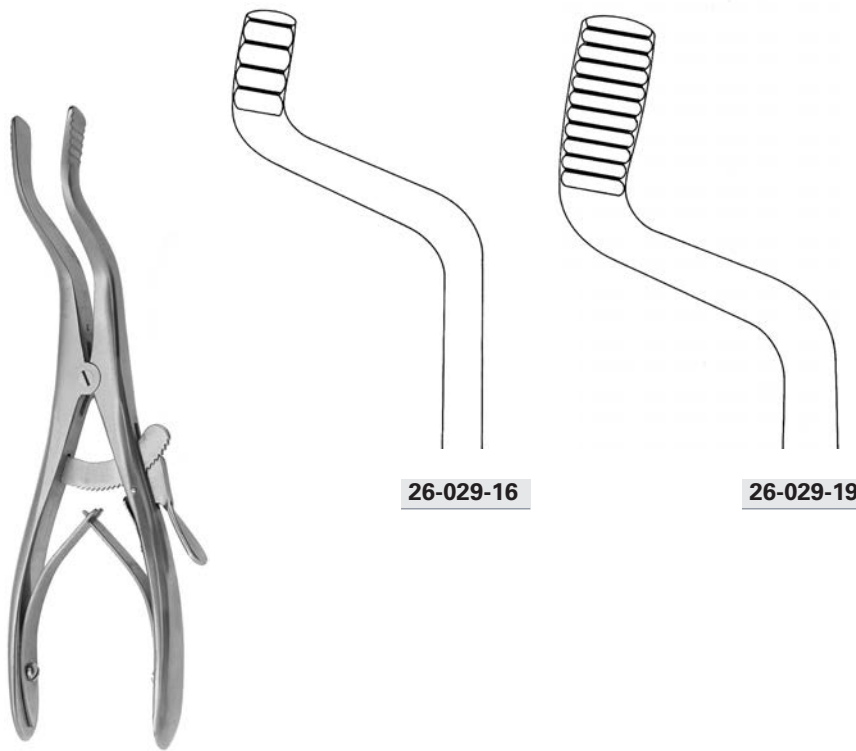

26-029-16

26-029-19

ROSER-KOENIG

26-029-16	16,0 cm, 6 1/4"
26-029-19	19,0 cm, 7 1/2"

ohne Zungendrucker
without tongue depressor
sin depressor lingual
senza abbassalingua

mit Zungendrucker
with tongue depressor
con depressor lingual
con abbassalingua

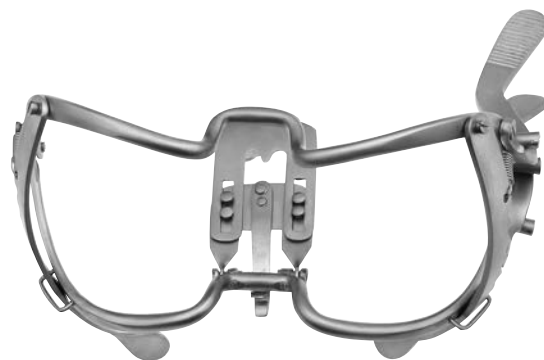
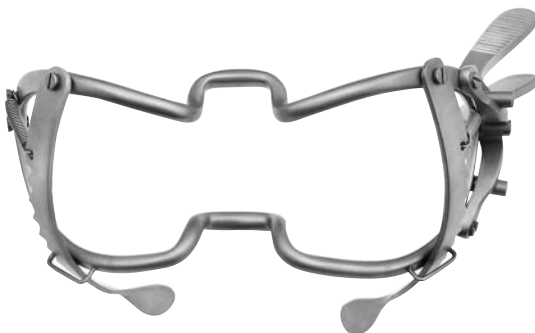

WHITEHEAD

26-031-09	9,0 cm, 3 1/2"
26-031-11	11,0 cm, 4 3/8"
26-031-13	13,0 cm, 5 1/8"
26-031-15	15,0 cm, 5 7/8"

WHITEHEAD

26-032-11	11,0 cm, 4 3/8"
26-032-13	13,0 cm, 5 1/8"
26-032-15	15,0 cm, 5 7/8"

ohne Zungendrucker
 without tongue depressor
 sin depressor lingual
 senza abbassalingua

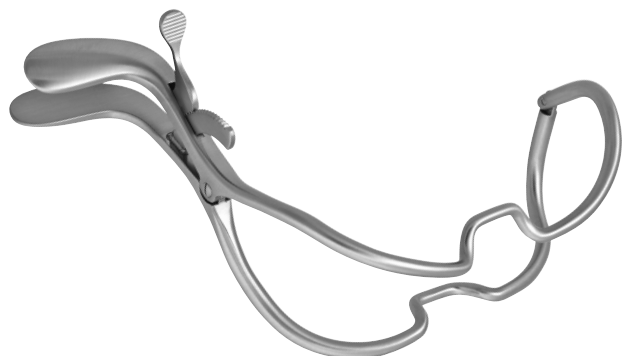

AMNOTEK-JENNINGS

26-033-01	9,0 cm, 3 1/2 "
26-033-02	11,0 cm, 4 3/8 "
26-033-03	13,0 cm, 5 1/8 "
26-033-04	15,0 cm, 5 7/8 "

ohne Zungendrucker
 without tongue depressor
 sin depressor lingual
 senza abbassalingua

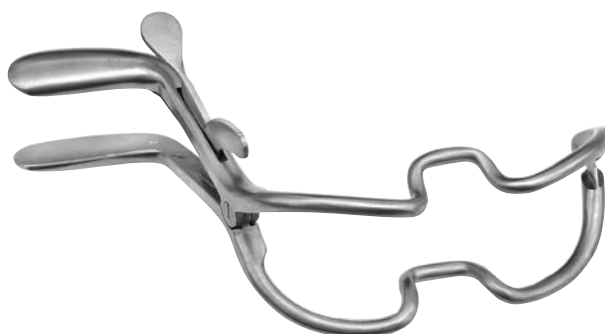

JENNINGS

26-033-09	9,0 cm, 3 1/2 "
26-033-11	11,0 cm, 4 3/8 "
26-033-13	13,0 cm, 5 1/8 "
26-033-15	15,0 cm, 5 7/8 "

ohne Zungendrucker
 without tongue depressor
 sin depressor lingual
 senza abbassalingua



SEEMANN-SEIFFERT

26-034-09	9,0 cm, 3 1/2 "
26-034-11	11,0 cm, 4 3/8 "
26-034-13	13,0 cm, 5 1/8 "
26-034-15	15,0 cm, 5 7/8 "



Rahmen, mit 2 beweglichen Seitenvalven
Frame, with 2 adjustable lateral valves
Bastidor, con 2 valvas laterales movibles
Telaio, con 2 valve laterali mobili

DINGMANN

26-035-00 SET

Komplett, bestehend aus:

1 Rahmen	26-035-04
1 Zungendrücker, Fig. 1	26-035-01
1 Zungendrücker, Fig. 2	26-035-02
1 Zungendrücker, Fig. 3	26-035-03

Complete, consisting of:

1 Frame	26-035-04
1 Tounge depressor, Fig. 1	26-035-01
1 Tounge depressor, Fig. 2	26-035-02
1 Tounge depressor, Fig. 3	26-035-03

Completo, compuesto de:

1 Bastidor	26-035-04
1 Bajalengua, Fig. 1	26-035-01
1 Bajalengua, Fig. 2	26-035-02
1 Bajalengua, Fig. 3	26-035-03

Completo, composto da:

1 Telaio	26-035-04
1 Abassalingua, Fig. 1	26-035-01
1 Abassalingua, Fig. 2	26-035-02
1 Abassalingua, Fig. 3	26-035-03



26-035-01

65 x 25 mm



26-035-02

70 x 29 mm



26-035-03

80 x 32 mm



DAVIS-MEYER

26-040-00



DAVIS-MEYER

26-040-03

Gaumenplatte
 palate plate
 plaquita paladial
 placca per palato



DAVIS-MEYER

26-040-02

Ersatz Silikoneinlagen
 Spare silicone inserts
 Plantilla de silicona
 Piastre di ricambio



DAVIS-MEYER

26-040-01



DAVIS-MEYER

26-053-01	70 x 29 mm
26-053-02	75 x 30 mm
26-053-03	80 x 31 mm
26-053-04	85 x 32 mm
26-053-05	95 x 33 mm
26-053-06	100 x 33 mm
26-053-07	105 x 34 mm



DAVIS-BOYLE

26-040-90 SET

Komplett, bestehend aus:

1 Rahmen	26-041-00
1 Zungendrücker, Fig. 1	26-055-01
1 Zungendrücker, Fig. 2	26-055-02
1 Zungendrücker, Fig. 3	26-055-03
1 Zungendrücker, Fig. 4	26-055-04
1 Zungendrücker, Fig. 5	26-055-05

Complete, consisting of:

1 Frame	26-041-00
1 Tounge depressor, Fig. 1	26-055-01
1 Tounge depressor, Fig. 2	26-055-02
1 Tounge depressor, Fig. 3	26-055-03
1 Tounge depressor, Fig. 4	26-055-04
1 Tounge depressor, Fig. 5	26-055-05

Completo, compuesto de:

1 Bastidor	26-041-00
1 Bajalengua, Fig. 1	26-055-01
1 Bajalengua, Fig. 2	26-055-02
1 Bajalengua, Fig. 3	26-055-03
1 Bajalengua, Fig. 4	26-055-04
1 Bajalengua, Fig. 5	26-055-05

Completo, composto da:

1 Telaio	26-041-00
1 Abassalingua, Fig. 1	26-055-01
1 Abassalingua, Fig. 2	26-055-02
1 Abassalingua, Fig. 3	26-055-03
1 Abassalingua, Fig. 4	26-055-04
1 Abassalingua, Fig. 5	26-055-05



26-055-01

25 x 19 mm

26-055-02

62 x 25 mm

26-055-03

75 x 25 mm

26-055-04

92 x 25 mm

26-055-05

108 x 25 mm



DAVIS-BOYLE

26-040-91 SET

Komplett, bestehend aus:

1 Rahmen	26-041-00
1 Zungendrucker, Fig. 1	26-055-01
1 Zungendrucker, Fig. 2	26-056-02
1 Zungendrucker, Fig. 3	26-056-03
1 Zungendrucker, Fig. 4	26-056-04
1 Zungendrucker, Fig. 5	26-056-05

Complete, consisting of:

1 Frame	26-041-00
1 Tounge depressor, Fig. 1	26-055-01
1 Tounge depressor, Fig. 2	26-056-02
1 Tounge depressor, Fig. 3	26-056-03
1 Tounge depressor, Fig. 4	26-056-04
1 Tounge depressor, Fig. 5	26-056-05

Completo, compuesto de:

1 Bastidor	26-041-00
1 Bajalengua, Fig. 1	26-055-01
1 Bajalengua, Fig. 2	26-056-02
1 Bajalengua, Fig. 3	26-056-03
1 Bajalengua, Fig. 4	26-056-04
1 Bajalengua, Fig. 5	26-056-05

Completo, composto da:

1 Telaio	26-041-00
1 Abassalingua, Fig. 1	26-055-01
1 Abassalingua, Fig. 2	26-056-02
1 Abassalingua, Fig. 3	26-056-03
1 Abassalingua, Fig. 4	26-056-04
1 Abassalingua, Fig. 5	26-056-05



26-055-01

25 x 19 mm

26-056-02

62 x 25 mm

26-056-03

75 x 25 mm

26-056-04

92 x 25 mm

26-056-05

108 x 25 mm



DAVIS-BOYLE

26-040-92 SET

Komplett, bestehend aus:

1 Rahmen	26-041-02
1 Zungendrücker, Fig. 1	26-055-01
1 Zungendrücker, Fig. 2	26-055-02
1 Zungendrücker, Fig. 3	26-055-03
1 Zungendrücker, Fig. 4	26-055-04
1 Zungendrücker, Fig. 5	26-055-05

Complete, consisting of:

1 Frame	26-041-02
1 Tounge depressor, Fig. 1	26-055-01
1 Tounge depressor, Fig. 2	26-055-02
1 Tounge depressor, Fig. 3	26-055-03
1 Tounge depressor, Fig. 4	26-055-04
1 Tounge depressor, Fig. 5	26-055-05

Completo, compuesto de:

1 Bastidor	26-041-02
1 Bajalengua, Fig. 1	26-055-01
1 Bajalengua, Fig. 2	26-055-02
1 Bajalengua, Fig. 3	26-055-03
1 Bajalengua, Fig. 4	26-055-04
1 Bajalengua, Fig. 5	26-055-05

Completo, composto da:

1 Telaio	26-041-02
1 Abassalingua, Fig. 1	26-055-01
1 Abassalingua, Fig. 2	26-055-02
1 Abassalingua, Fig. 3	26-055-03
1 Abassalingua, Fig. 4	26-055-04
1 Abassalingua, Fig. 5	26-055-05



26-055-01

25 x 19 mm

26-055-02

62 x 25 mm

26-055-03

75 x 25 mm

26-055-04

92 x 25 mm

26-055-05

108 x 25 mm



DAVIS-BOYLE

26-040-93 SET

Komplett, bestehend aus:

1 Rahmen	26-041-02
1 Zungendrucker, Fig. 1	26-055-01
1 Zungendrucker, Fig. 2	26-056-02
1 Zungendrucker, Fig. 3	26-056-03
1 Zungendrucker, Fig. 4	26-056-04
1 Zungendrucker, Fig. 5	26-056-05

Complete, consisting of:

1 Frame	26-041-02
1 Tounge depressor, Fig. 1	26-055-01
1 Tounge depressor, Fig. 2	26-056-02
1 Tounge depressor, Fig. 3	26-056-03
1 Tounge depressor, Fig. 4	26-056-04
1 Tounge depressor, Fig. 5	26-056-05

Completo, compuesto de:

1 Bastidor	26-041-02
1 Bajalengua, Fig. 1	26-055-01
1 Bajalengua, Fig. 2	26-056-02
1 Bajalengua, Fig. 3	26-056-03
1 Bajalengua, Fig. 4	26-056-04
1 Bajalengua, Fig. 5	26-056-05

Completo, composto da:

1 Telaio	26-041-02
1 Abassalingua, Fig. 1	26-055-01
1 Abassalingua, Fig. 2	26-056-02
1 Abassalingua, Fig. 3	26-056-03
1 Abassalingua, Fig. 4	26-056-04
1 Abassalingua, Fig. 5	26-056-05



26-055-01

25 x 19 mm



26-056-02

62 x 25 mm



26-056-03

75 x 25 mm



26-056-04

92 x 25 mm



26-056-05

108 x 25 mm

drehbar
rotatable
giratorio
girevole



DAVIS-BOYLE

26-041-01

für Kinder
for children
para niños
per bambini



DAVIS-BOYLE

26-042-00

für Jugendliche
for teenager
para adolescente
per giovanetto



DAVIS-BOYLE

26-043-00

für Jugendliche
for teenager
para adolescente
per giovanetto



DAVIS-BOYLE

26-043-01



KILNER-DOUGHTY

26-044-00 SET

Komplett, bestehend aus:	Complete, consisting of:
1 Rahmen 26-044-19	1 Frame 26-044-19
1 Zungendrücker, Fig. 1 26-050-01	1 Tounge depressor, Fig. 1 26-050-01
1 Zungendrücker, Fig. 2 26-050-02	1 Tounge depressor, Fig. 2 26-050-02
1 Zungendrücker, Fig. 3 26-050-03	1 Tounge depressor, Fig. 3 26-050-03
1 Gaumenplatte 26-044-02	1 Gaumenplatte 26-044-02

Completo, compuesto de:	Completo, composto da:
1 Bastidor 26-044-19	1 Telaio 26-044-19
1 Bajalengua, Fig. 1 26-050-01	1 Abassalingua, Fig. 1 26-050-01
1 Bajalengua, Fig. 2 26-050-02	1 Abassalingua, Fig. 2 26-050-02
1 Bajalengua, Fig. 3 26-050-03	1 Abassalingua, Fig. 3 26-050-03
1 Plaquita paladia 26-044-02	1 Placca per palato 26-044-02



26-050-01

65 x 28 mm



26-050-02

75 x 32 mm



26-050-03

80 x 37 mm



26-044-02



MC IVOR

26-045-01 SET

Komplett, bestehend aus:

1 Rahmen	26-045-00
1 Zungendrücker, Fig. 1	26-054-01
1 Zungendrücker, Fig. 2	26-054-02
1 Zungendrücker, Fig. 3	26-054-03

Complete, consisting of:

1 Frame	26-045-00
1 Tounge depressor, Fig. 1	26-054-01
1 Tounge depressor, Fig. 2	26-054-02
1 Tounge depressor, Fig. 3	26-054-03

Completo, compuesto de:

1 Bastidor	26-045-00
1 Bajalengua, Fig. 1	26-054-01
1 Bajalengua, Fig. 2	26-054-02
1 Bajalengua, Fig. 3	26-054-03

Completo, composto da:

1 Telaio	26-045-00
1 Abassalingua, Fig. 1	26-054-01
1 Abassalingua, Fig. 2	26-054-02
1 Abassalingua, Fig. 3	26-054-03



26-054-01

70 x 23 mm



26-054-02

86 x 25 mm



26-054-03

100 x 26 mm



DINGMANN

26-035-01	65 x 25 mm
26-035-02	70 x 29 mm
26-035-03	80 x 32 mm

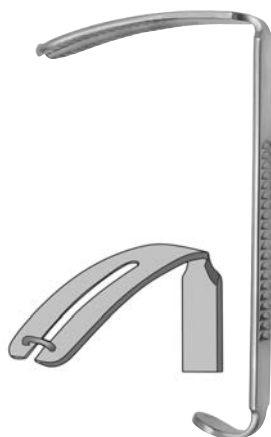

DOUGHTY

26-048-01	65 mm
26-048-02	75 mm
26-048-03	90 mm
26-048-04	102 mm
26-048-05	115 mm



26-049-01	65 mm
26-049-02	75 mm
26-049-03	90 mm
26-049-04	102 mm



RUSSEL-DAVIS

26-050-01	65 x 28 mm
26-050-02	75 x 32 mm
26-050-03	80 x 37 mm
26-050-04	94 x 41 mm
26-050-05	103 x 46 mm



RUSSEL-DAVIS

26-051-01	57 x 18 mm
26-051-02	67 x 22 mm
26-051-03	75 x 25 mm



GAST

26-052-01	64 x 28 mm
26-052-02	74 x 34 mm
26-052-03	87 x 38 mm
26-052-04	95 x 40 mm
26-052-05	103 x 45 mm



DAVIS-MEYER

26-053-01	70 x 29 mm
26-053-02	75 x 30 mm
26-053-03	80 x 31 mm
26-053-04	85 x 32 mm
26-053-05	95 x 33 mm
26-053-06	100 x 33 mm
26-053-07	105 x 34 mm



MC IVOR

26-054-01	70 x 23 mm
26-054-02	86 x 25 mm
26-054-03	100 x 26 mm



MC IVOR

26-054-11	70 x 23 mm
26-054-12	86 x 25 mm
26-054-13	100 x 26 mm



DAVIS-BOYLE

26-055-02	65 x 22 mm
26-055-03	75 x 25 mm
26-055-04	92 x 25 mm
26-055-05	108 x 25 mm



DAVIS-BOYLE

26-055-01	25 x 19 mm
26-056-02	65 x 25 mm
26-056-03	75 x 25 mm
26-056-04	92 x 25 mm
26-056-05	108 x 25 mm



WUERZBURG

26-057-01	66 x 28 mm
26-057-02	75 x 32 mm
26-057-03	83 x 34 mm
26-057-04	93 x 37 mm
26-057-05	100 x 38 mm



RING

26-058-02	58 x 23 mm
26-058-03	72 x 27 mm
26-058-04	87 x 34 mm
26-058-05	95 x 37 mm

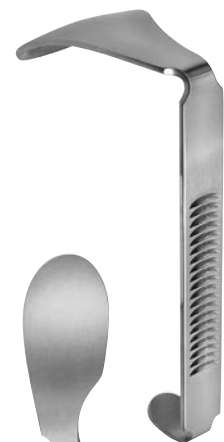

HERBERHOLD

26-059-01	75 x 32 mm
26-059-02	83 x 34 mm
26-059-03	93 x 37 mm
26-059-04	100 x 38 mm

Bruststütze für alle Mundsperrer
 Chest support for all mouth gags
 Soporte de pecho para todos los abre bocas
 Supporto sternale per tutti gli apribocca



Band zur Befestigung der NEGUS Bruststütze
 Band to fix the NEGUS chest support
 Banda para la sujeción del apoyo pectoral NEGUS
 Fascia per il fissaggio del supporto petto NEGUS



NEGUS

26-060-00	140 mm
26-060-01	110 mm
26-060-02	85 mm

NEGUS

26-060-05

Halterahmen für Mundsperrer
 Holding frame for mouth gags
 Bastidor de soporte para abre bocas
 Supporto per gli apribocca

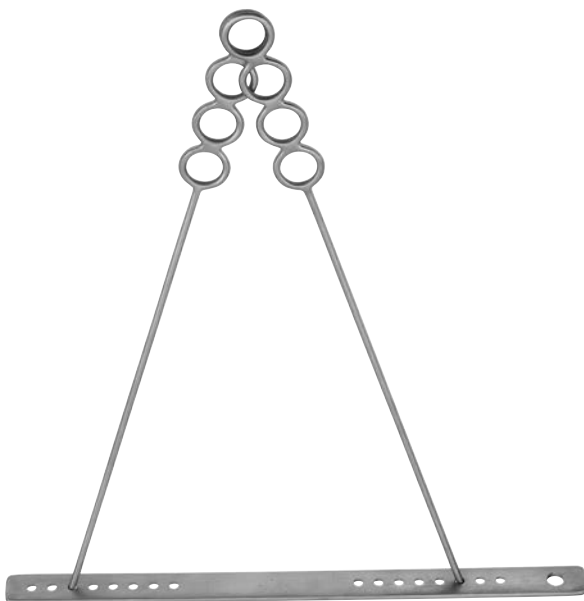

DRAFFIN

26-060-90

Ersatz Stangen, 2 Stück
 Spare bars, 2 pcs.
 Barras de repuesto, 2 unidades
 Asta di ricambio, 2 pezzi

DRAFFIN

26-060-91

Ersatz Halteplatte
 Spare holding plate
 Placa de soporte de repuesto
 Piastra di supporto di ricambio

DRAFFIN

26-060-92



CAWOOD-MINNESOTA

26-069-15 15,0 cm, 6 "



STERNBERG

26-070-12 12,0 cm, 4 ¾ "
26-070-14 14,0 cm, 5 ½ "
26-070-16 16,0 cm, 6 ¼ "



26-071-19 19,0 cm, 7 ½ "

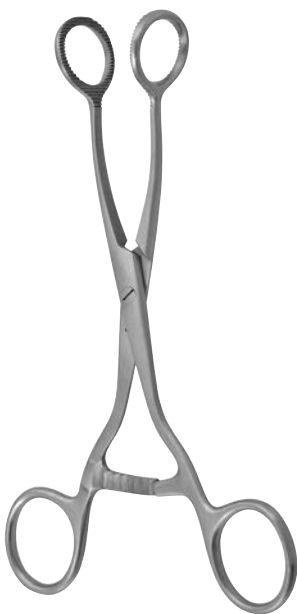

COLLIN

26-072-16 16,0 cm, 6 ¼ "
26-072-18 18,0 cm, 7 "



YOUNG

26-073-16 16,0 cm, 6 ¼ "

Ersatz Gummipolster für 26-073-16
Spare rubber Inserts for 26-073-16
Bocas de goma de repuesto para 26-073-16
Cuscino di gomma di ricambio per 26-073-16

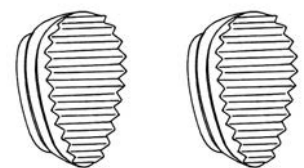

YOUNG

26-073-99



SIMPLEX

26-074-11 10,5 cm, 4 1/4"

Fig. 1

26-075-01

Fig. 2

26-075-02

1 Paar
 Set of 2
 Juego de 2
 Confezione da 2

Fig. 3

26-075-03



MC KESSON

26-075-01 - 26-075-03

Mundkeil, aus Holz
 Oral screw, made of wood
 Tornillo oral, en madera
 Apribocca elicoidale in legno

Ø 32,0 mm



MAUNDER

26-075-10 9,5 cm, 3 3/4"

Mundkeil, aus Silikon
 Oral screw, made of silicone
 Tornillo oral, en silicona
 Apribocca elicoidale in silicona



PITHA

26-076-10 28 x 30 mm



ADAMS

26-077-00 28 x 30 mm



LANGENBECK

26-079-01 Ø 17 - 21 mm
26-079-02 Ø 19 - 24 mm
26-079-03 Ø 21 - 26 mm

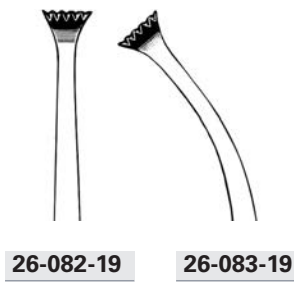

26-082-19

26-083-19



26-085-18

26-085-23

CLOVER

26-082-19 - 26-083-19 19,0 cm, 7 1/2"

WHITE

26-085-18 18,0 cm, 7"

26-085-23 23,0 cm, 9"

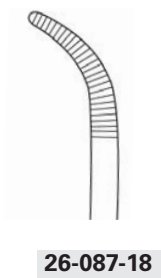

26-087-18

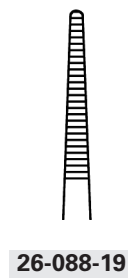

26-088-19

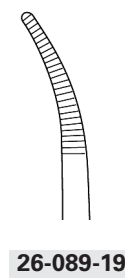

26-089-19

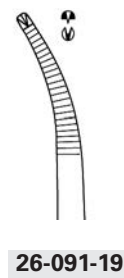

26-091-19

SAWTELL

26-087-18 19,0 cm, 7 1/2"

SCHNIDT

26-088-19 - 26-091-19 19,5 cm, 7 3/4"

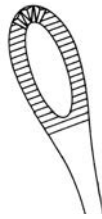

26-093-20

BLOHMKE

26-093-20 20,0 cm, 8"

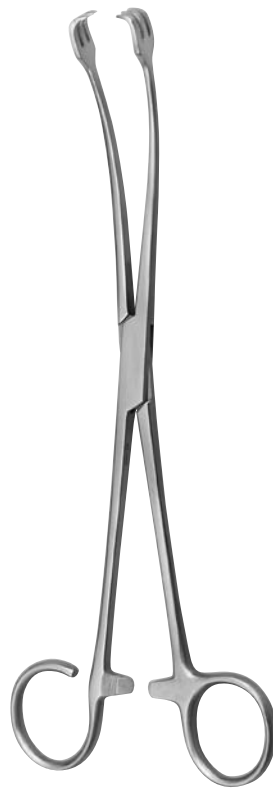

BALLENGER

26-094-21 21,5 cm, 8 1/2"



MARSHIK-KRONE

26-095-20 20,0 cm, 8"



MARSHIK

26-096-22 22,0 cm, 8 3/4"



26-097-21



26-097-22

TYDING-TIVNEN

26-097-21 - 26-097-22 21,0 cm, 8 1/4"



ABRAHAM

26-098-20 20,5 cm, 8"



mit Absaugvorrichtung
with suction device
con succión
con aspiratore

LOPEZ-REINKE

26-099-23 23,5 cm, 9 1/4"



Tonsillenmesser und Enukleator
Tonsil knife and enucleator
Cuchillo y enucleador para amígdalas
Bisturi enucleatore per tonsille

CARPENTER

26-100-01 25,0 cm, 9 3/4"

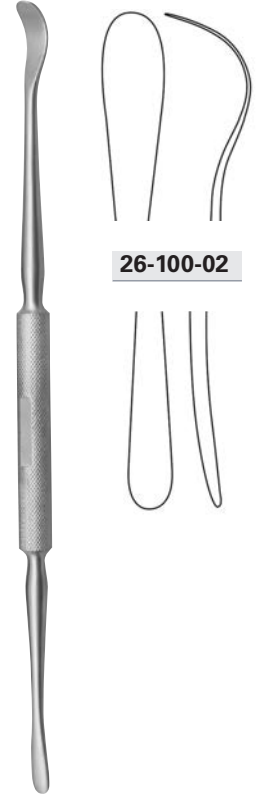

CARPENTER

26-100-02 24,0 cm, 9 1/2"

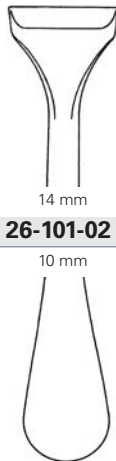

HURD

26-101-01 - 26-101-03 21,5 cm, 8 1/2"

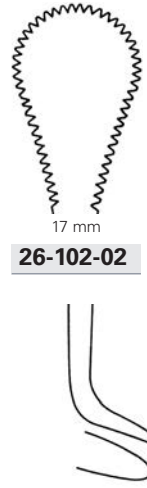
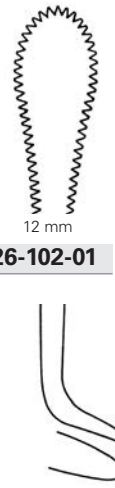

HENKE

26-102-01 - 26-102-02 23,5 cm, 9 1/4"



26-103-06 6,0 mm
26-103-08 8,0 mm



mit Schutzhülse
 with protection shield
 con funda protectora
 con guaina protettiva



GWYNE-EVANS

26-103-06 - 26-103-08 20,0 cm, 8 "

FISCHER

26-104-18 18,0 cm, 7 "

26-109-20 20,5 cm, 8 "



Tonsillenabszesszange
 Tonsil abscess forceps
 Pinza para abscesos
 de las amígdalas
 Pinze per ascessi
 tonsillari

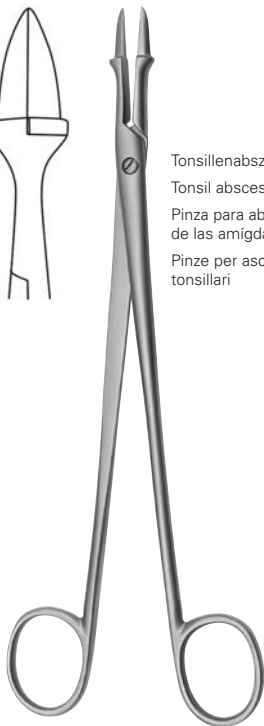

ohne Raste
 without ratchet
 sin cremallera
 senza cremagliera



mit Raste
 with ratchet
 con cremallera
 con cremagliera



mit Raste
 with ratchet
 con cremallera
 con cremagliera

THILENIUS

26-110-19 19,0 cm, 7 ½ "

EVES

26-150-26 28,0 cm, 11 "

EVES

26-152-25 28,0 cm, 11 "

BRUENINGS

26-154-27 27,0 cm, 10¾ "

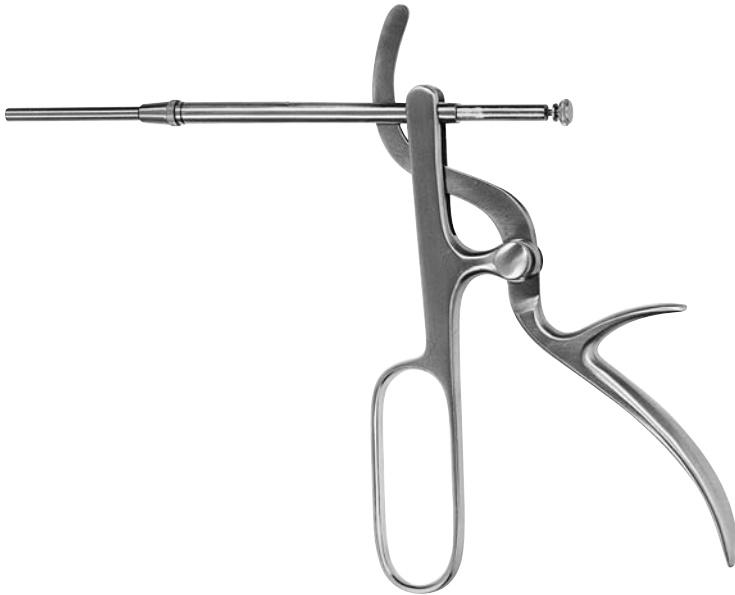

TYDING

26-155-00



TYDING

26-155-01

gerader Aufsatz allein
straight tip only
punta recta suelto
punta diritta solo



VEEDER

26-155-02

Aufsatz allein
Tip only
Punta suelto
Punta solo



Verpackungseinheit: 12 St.
Packing unit: 12 pieces
Unidad: 12 piezas
Confezione: 12 pezzi

Schnürdrähte
Snare wires
Alambre para amigdalótomo
Filo per serranodi



Verpackungseinheit: 100 St.
Packing unit: 100 pieces
Unidad: 100 piezas
Confezione: 100 pezzi

Schnürdrähte
Snare wires
Alambre para amigdalótomo
Filo per serranodi



Verpackungseinheit: 100 St.
Packing unit: 100 pieces
Unidad: 100 piezas
Confezione: 100 pezzi

Drahtschlingen
Wire loops
Asas de alambre
Laccio per serranodi

Schnürdrähte, Rolle mit 10 m
Snare wires, coil of 10 m
Alambre para amigdalótomo, rollo de 10 m
Filo per serranodi, rotolo da 10 m



26-156-03 Ø 0,3 mm
26-156-05 Ø 0,5 mm



26-156-13 Ø 0,3 mm
26-156-14 Ø 0,4 mm
26-156-15 Ø 0,5 mm



26-157-04 Ø 0,4 | 40 mm
26-157-05 Ø 0,4 | 50 mm



26-158-02 Ø 0,2 mm
26-158-03 Ø 0,3 mm
26-158-04 Ø 0,4 mm



SLUDER-BALLENGER

26-159-00 SET

Komplett, bestehend aus:		Complete, consisting of:	
1 Griff	26-159-04	1 Handle	26-159-04
1 Aufsatz, Fig. 1	26-159-01	1 Tip, Fig. 1	26-159-01
1 Aufsatz, Fig. 2	26-159-02	1 Tip, Fig. 2	26-159-02
1 Aufsatz, Fig. 3	26-159-03	1 Tip, Fig. 3	26-159-03

Completo, compuesto de:		Completo, composto da:	
1 Mango	26-159-04	1 Manico	26-159-04
1 Punta, Fig. 1	26-159-01	1 Punta, Fig. 1	26-159-01
1 Punta, Fig. 2	26-159-02	1 Punta, Fig. 2	26-159-02
1 Punta, Fig. 3	26-159-03	1 Punta, Fig. 3	26-159-03

Aufsatz
Blade
Punta
Lama

Aufsatz
Blade
Punta
Lama

Aufsatz
Blade
Punta
Lama

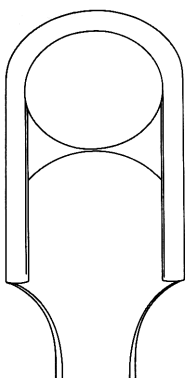

26-159-01

Fig. 1

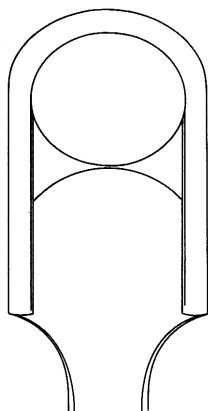

26-159-02

Fig. 2

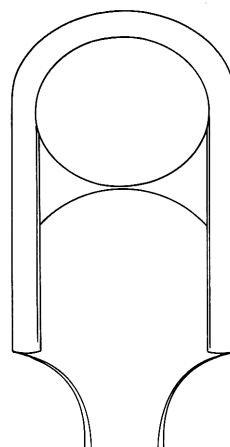

26-159-03

Fig. 3

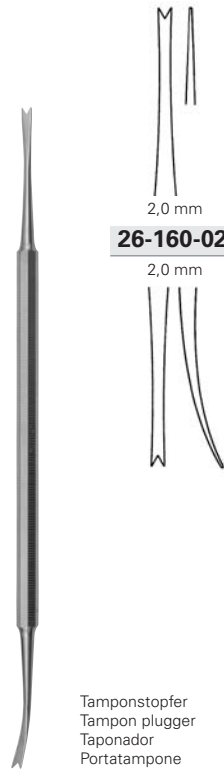
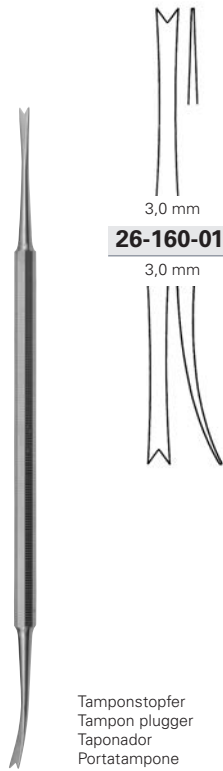

LUNIATSCHEK

26-160-01 17,5 cm, 7 "

LUNIATSCHEK

26-160-02 17,5 cm, 7 "

HURD

26-163-21 21,0 cm, 8 ¼ "

HURD

26-165-21 21,0 cm, 8 ¼ "

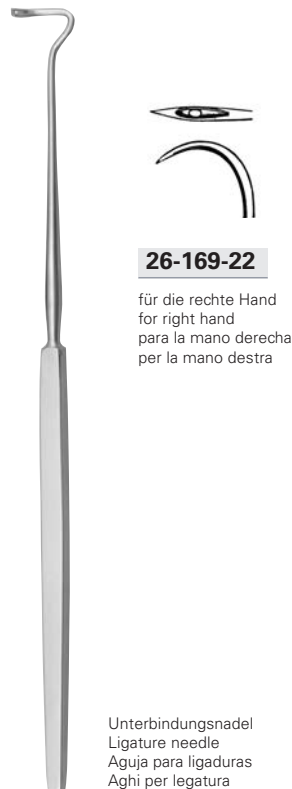

CLAUS V. EICKEN

26-167-25 25,0 cm, 9 ¾ "

DUPUY-WEISS

26-169-22 22,0 cm, 8 "

DUPUY-WEISS

26-171-22 22,0 cm, 8 "



Ligaturinstrument
Ligature instrument
Cierra-nudos para amígdalas
Serranodi per tonsille

ROEDER

26-172-26 26,5 cm, 10 1/2"



26-173-21

Fadenfänger
Ligature catcher
Captador de hilos
Portalegature

HOEN V. EICKEN

26-173-21 21,0 cm, 8 1/4"

Gaumensegelhalter
Soft palate retractor
Separador para velo del paladar
Divaricatore per velo pendulo



HASLINGER

26-174-00 17,0 cm, 6 3/4"

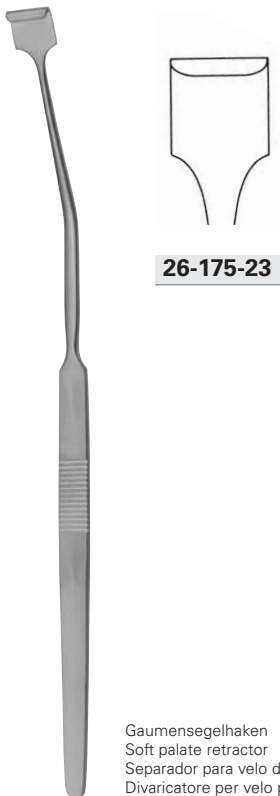

26-175-23

Gaumensegelhaken
Soft palate retractor
Separador para velo del paladar
Divaricatore per velo pendulo

NAGER

26-175-23 24,0 cm, 9 1/2"



26-176-18 18 mm

26-176-20 20 mm

26-176-22 22 mm

LOVE

26-176-18 - 26-176-22 15,0 cm, 6"

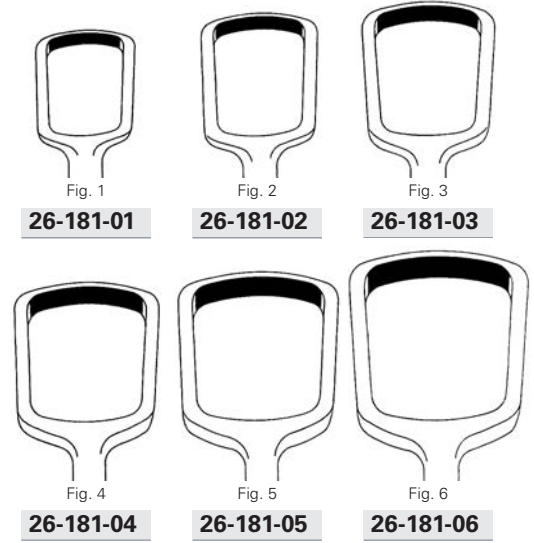
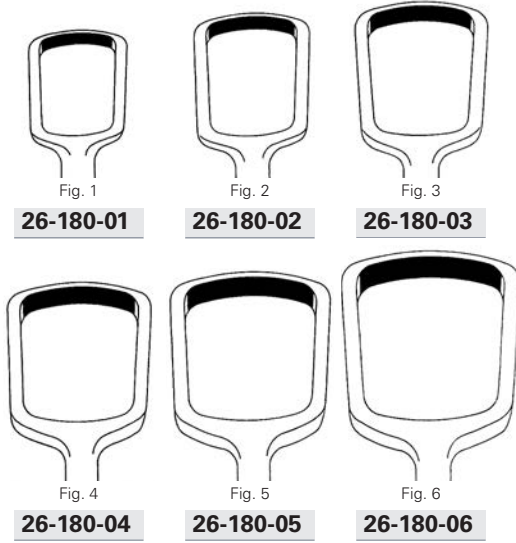

BECKMANN

26-180-01 - 26-180-06 22,5 cm, 9"

BECKMANN

26-181-01 - 26-181-06 22,5 cm, 9"

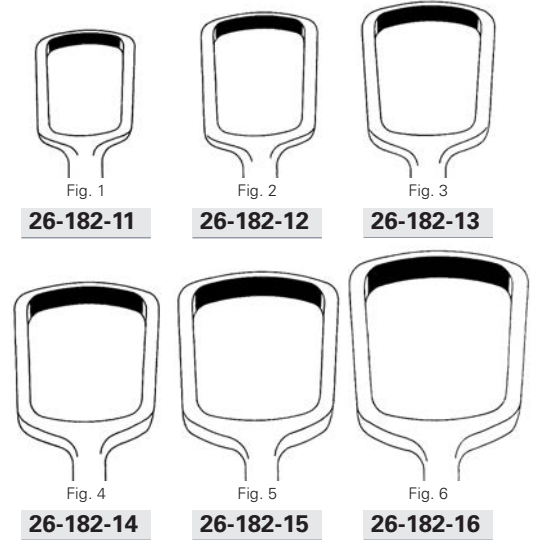
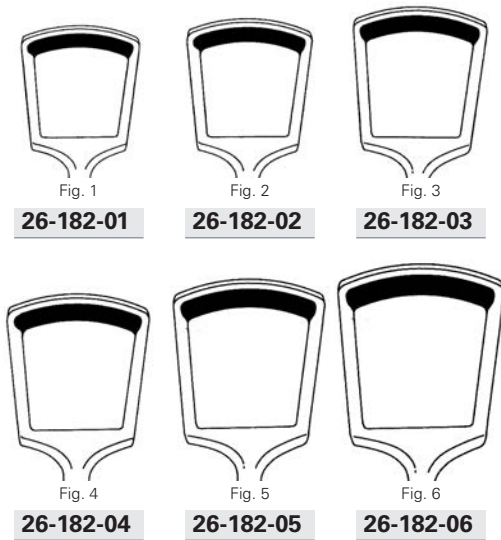

mit Fangkorb
with basket
con cesto
con raccogliore

BECKMANN

26-182-01 - 26-182-06 22,5 cm, 9"

BECKMANN

26-182-11 - 26-182-16 22,5 cm, 9"

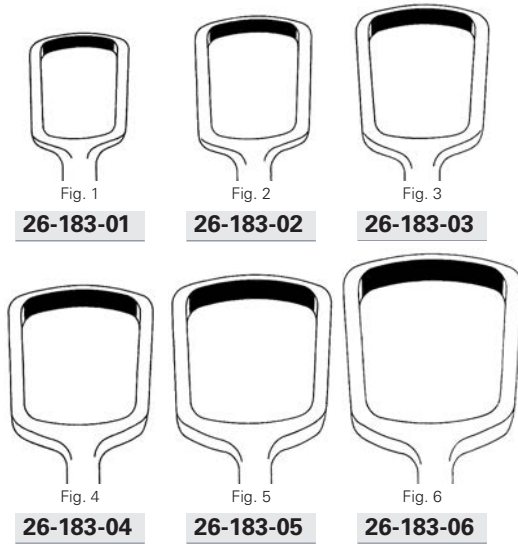

NEGUS

26-183-01 - 26-183-06 22,5 cm, 9 "

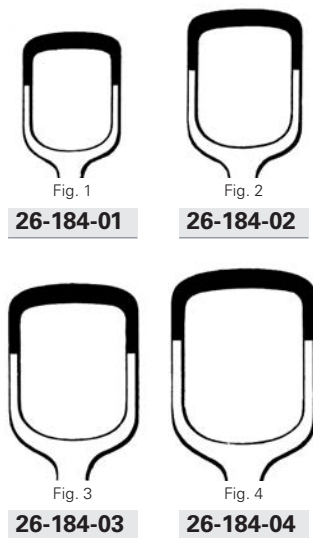

BARNHILL

26-184-01 - 26-184-04 20,0 cm, 8 "

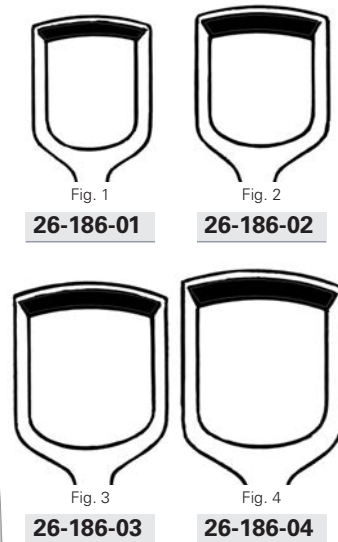

mit Fangkorb
 with basket
 con cesto
 con raccogliore

ST. CLAIR-THOMSON

26-186-01 - 26-186-04 21,0 cm, 8 ¼ "

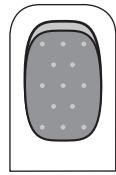

Fig. 1

26-187-01

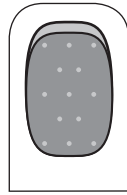

Fig. 2

26-187-02

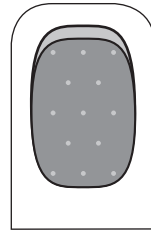

Fig. 3

26-187-03

26-187-11 Fig. 1 | 12 mm
26-187-12 Fig. 2 | 16 mm
26-187-13 Fig. 3 | 18 mm

Ersatzklingen, gelocht
Spare Blades, perforated
Hojas de repuesto, perforada
Lama di ricambio, perforate

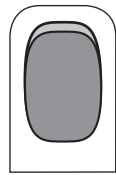

Fig. 1

26-187-04

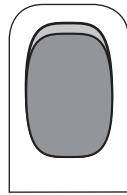

Fig. 2

26-187-05

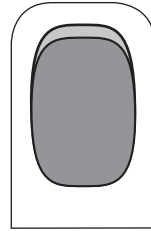

Fig. 3

26-187-06

26-187-14 Fig. 1 | 12 mm
26-187-15 Fig. 2 | 16 mm
26-187-16 Fig. 3 | 18 mm

Ersatzklingen, ungelocht
Spare Blades, non perforated
Hojas de repuesto, no perforada
Lama di ricambio, non perforate

LA FORCE

26-187-01 - 26-187-06 23,0 cm, 9"

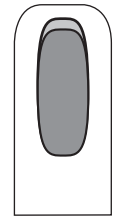

Fig. 0

26-188-00

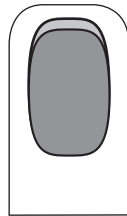

Fig. 1

26-188-01

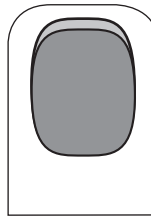

Fig. 2

26-188-02

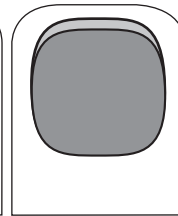

Fig. 3

26-188-03

26-188-10 Fig. 0 | 10 mm
26-188-11 Fig. 1 | 13 mm
26-188-12 Fig. 2 | 16 mm
26-188-13 Fig. 3 | 19 mm

Ersatzklingen, ungelocht
Spare Blades, non perforated
Hojas de repuesto, no perforada
Lama di ricambio, non perforate

SHAMBOUGH

26-188-00 - 26-188-03 23,0 cm, 9"

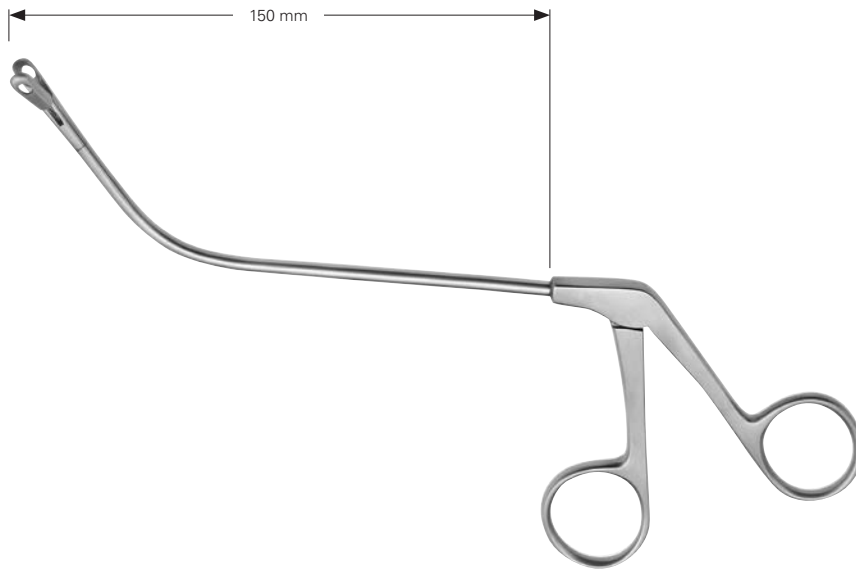

JATHO

26-193-24 24,0 cm, 9 1/2"

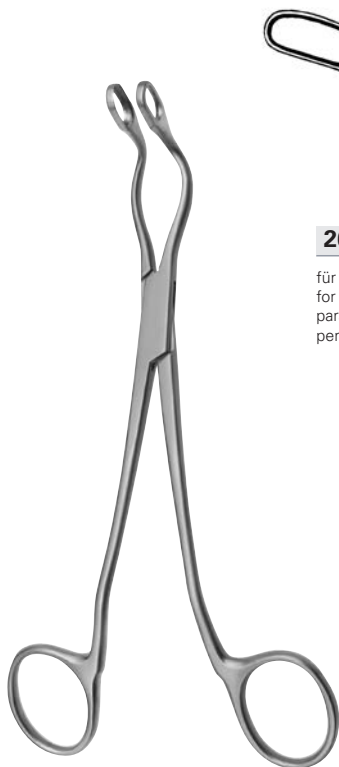

26-195-01

für Kinder
for children
para niños
per bambini

JURASZ

26-195-01 19,0 cm, 7 1/2"



26-195-02

26-195-03

JURASZ

26-195-02 - 26-195-03 21,0 cm, 8 1/4"

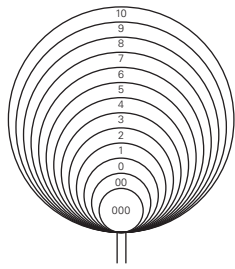

26-200-06	6 mm Fig. 000
26-200-08	8 mm Fig. 00
26-200-10	10 mm Fig. 0
26-200-12	12 mm Fig. 1
26-200-14	14 mm Fig. 2
26-200-16	16 mm Fig. 3
26-200-18	18 mm Fig. 4
26-200-20	20 mm Fig. 5
26-200-22	22 mm Fig. 6
26-200-24	24 mm Fig. 7
26-200-26	26 mm Fig. 8
26-200-28	28 mm Fig. 9
26-200-30	30 mm Fig. 10

Kehlkopfspiegel, ohne Griff
Laryngeal mirrors, without handle
Espejos laríngeos, sin mango
Specchi laringei, senza manico



Metallgriff
Metal handle
mango metálico
Manico metallico



Metallgriff
Metal handle
mango metálico
Manico metallico

26-200-06 - 26-200-30 14,0 cm, 5 1/2 "

26-201-00 10,0 cm, 4 "

26-202-00 10,5 cm, 4 1/4 "

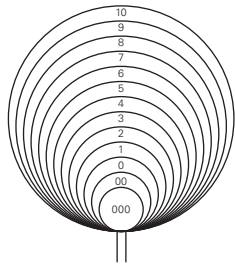

26-210-06	6 mm Fig. 000
26-210-08	8 mm Fig. 00
26-210-10	10 mm Fig. 0
26-210-12	12 mm Fig. 1
26-210-14	14 mm Fig. 2
26-210-16	16 mm Fig. 3
26-210-18	18 mm Fig. 4
26-210-20	20 mm Fig. 5
26-210-22	22 mm Fig. 6
26-210-24	24 mm Fig. 7
26-210-26	26 mm Fig. 8
26-210-28	28 mm Fig. 9
26-210-30	30 mm Fig. 10

Kehlkopfspiegel, mit festem Griff
Laryngeal mirrors, with fixed handle
Espejos laríngeos, sin mango fijo
Specchi laringei, con manico fisso

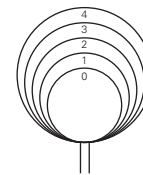

26-230-10	10 mm Fig. 0
26-230-12	12 mm Fig. 1
26-230-14	14 mm Fig. 2
26-230-16	16 mm Fig. 3
26-230-18	18 mm Fig. 4

Rhinoskopiespiegel, beweglich
Rhinoscopic mirrors, moveable
Espejos para rinoscopia, movable
Specchi per rinoscopia, mobili

26-210-06 - 26-210-30 19,0 cm, 7 1/2 "

26-230-10 - 26-230-18 25,0 cm, 9 3/4 "

MICHEL



REICHERT

26-241-23 24,0 cm, 9 1/4"



KILLIAN

26-243-25 25,0 cm, 9 3/4"

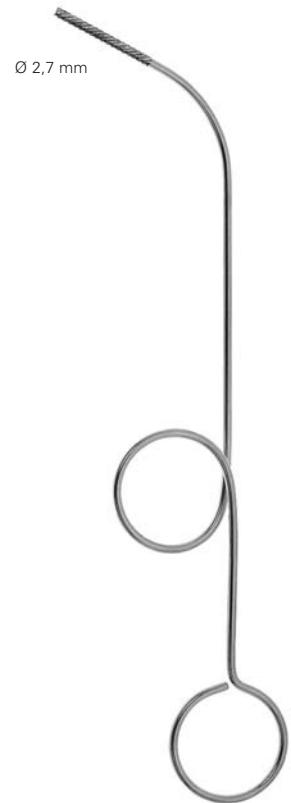

PELTESON

26-245-23 23,0 cm, 9"

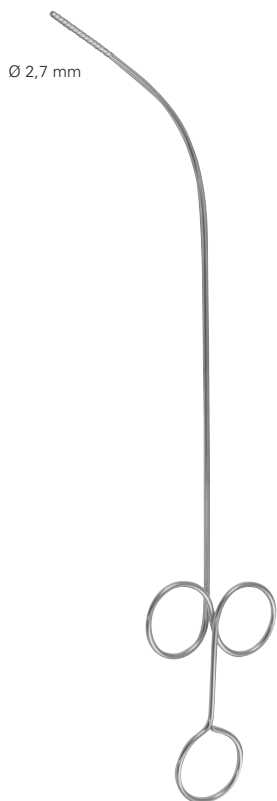

FEIN

26-245-28 28,0 cm, 11"

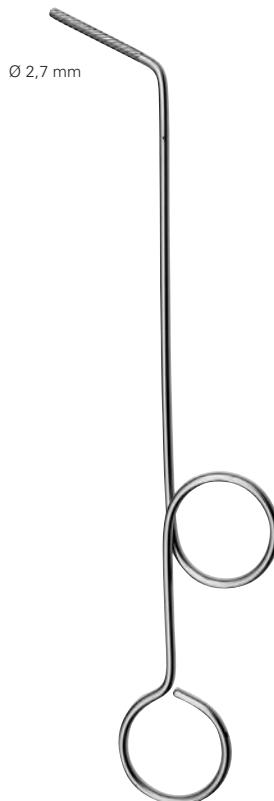

HARTMANN

26-246-22 22,0 cm, 8 3/4"

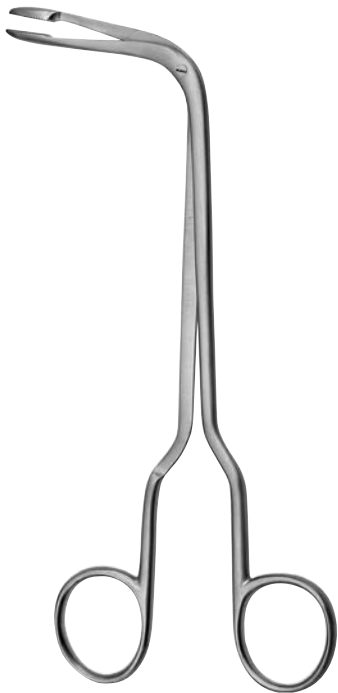

FRAENKEL

26-247-22 18,0 cm, 7 "



TOBOLD

26-249-23 23,0 cm, 9 "



26-251-01

rechts
right
derecha
destra

26-251-02

links
left
izquierda
sinistra

26-251-03

unten
downwards
hacia abajo
verso il basso

26-251-04

oben
upwards
hacia arriba
verso l'alto



JURASZ

26-251-01 - 26-251-04 22,0 cm, 8 ¾ "

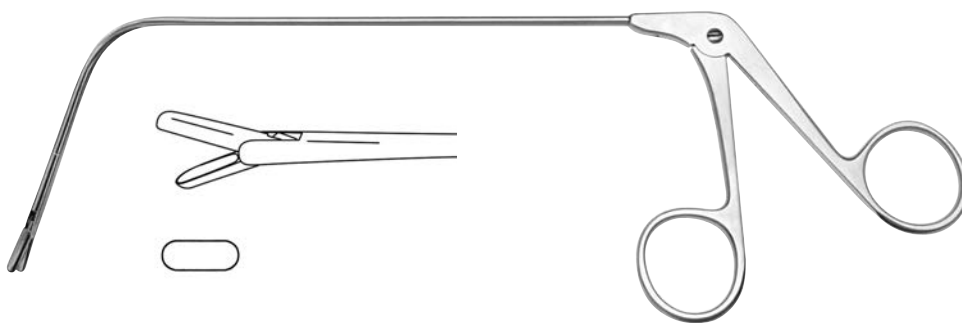

FRAENKEL

26-252-28 17,0 cm, 6 $\frac{3}{4}$ "

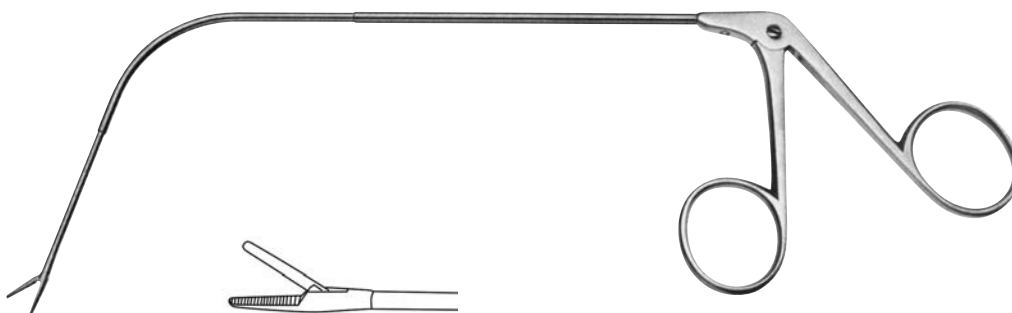

26-254-28 17,0 cm, 6 $\frac{3}{4}$ "



Universalgriff
Universal Handle
Mango universal
Manico universale

HUBER

26-262-00



BRUENINGS

26-262-20	200 mm
26-262-30	300 mm
26-262-40	400 mm
26-262-50	500 mm
26-262-60	600 mm

Verlängerungsrohre
Elongation tubes
Tubos de extensión
Tubi di prolungamento



BRUENINGS

26-267-20 200 mm

Verlängerungsrohr
Elongation tube
Tubo de extensión
Tubi di prolungamento



BRUENINGS

26-268-20

Verlängerungsrohr, biegsam
Elongation tube, malleable
Tubo de extensión, maleable
Tubi di prolungamento, malleabili



FRAENKEL

26-270-01



SEIFFERT

26-270-04



BRUENINGS

26-270-06 Ø 3,0 mm
 26-270-07 Ø 4,0 mm



LANGE

26-270-08 Ø 4,0 mm



BRUENINGS

26-270-09 Ø 3,0 mm
 26-270-10 Ø 4,0 mm



FRAENKEL

26-270-11



BRUENINGS

26-270-12 2,5 x 5,0 mm
 26-270-13 3,0 x 6,0 mm



SCHEINMANN

26-270-14



KRAUSE

26-270-15



KRAUSE

26-270-16



KRAUSE

26-270-17



SCHEINMANN

26-270-18



SCHUMACHER

26-270-19



CORDES

26-270-22 1,0 x 3,0 mm
 26-270-23 2,0 x 4,0 mm
 26-270-24 3,0 x 5,0 mm



CORDES

26-270-25 1,0 x 3,0 mm
 26-270-26 2,0 x 4,0 mm
 26-270-27 3,0 x 5,0 mm
 26-270-28 4,0 x 8,0 mm

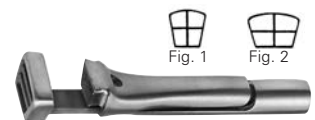

CORDES

26-270-30 Fig. 1
 26-270-31 Fig. 2



FRAENKEL

26-270-33

Bruststütze, für Erwachsene, komplett mit Stützstange
Chest support, for adults, complete with support rod
Soporte de pecho, para adultos, completo con barra de soporte
Supporto petto per adulti, completo con asta di supporto

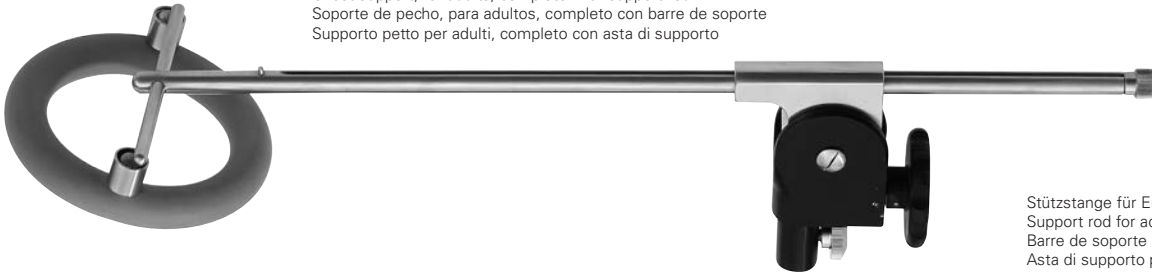

Stützstange für Erwachsene
Support rod for adults
Barra de soporte para adultos
Asta di supporto per adulti

26-280-00 34,0 cm, 13 3/8"

26-280-02 34,0 cm, 13 3/8"

Bruststütze, für Kinder, komplett mit Stützstange
Chest support, for children, complete with support rod
Soporte de pecho, para niños, completo con barra de soporte
Supporto petto per bambini, completo con asta di supporto



Stützstange für Kinder
Support rod for children
Barra de soporte para niños
Asta di supporto per bambini

26-280-10 24,0 cm, 9 1/2"

26-280-01 24,0 cm, 9 1/2"



Fig. 1 | Ø 11 mm

26-282-01

für Kleinkinder
for infants
para bebés
per noenati



Fig. 2 | Ø 11 mm

26-282-02

für Kinder
for children
para niños
per bambini



Fig. 3 | Ø 12 mm

26-282-03

für Erwachsene
for adults
para adultos
per adulti



Fig. 4 | Ø 14 mm

26-282-04

für Erwachsene
for adults
para adultos
per adulti



Fig. 5 | Ø 16 mm

26-282-05

für Erwachsene
for adults
para adultos
per adulti



Fig. 6 | 13x18 mm

26-282-06

für Erwachsene
for adults
para adultos
per adulti

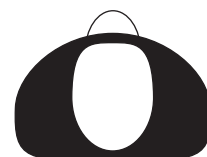

Fig. 7 | 13x18 mm

26-282-07

für Erwachsene
for adults
para adultos
per adulti

26-282-01	Fig. 1 135 mm
26-282-02	Fig. 2 152 mm
26-282-03	Fig. 3 182 mm
26-282-04	Fig. 4 172 mm
26-282-05	Fig. 5 172 mm
26-282-06	Fig. 6 182 mm
26-282-07	Fig. 7 222 mm



spreizbar
 spreadable
 extensible
 divaricabili

26-282-11	Fig. 1 135 mm
26-282-12	Fig. 2 152 mm
26-282-13	Fig. 3 182 mm
26-282-14	Fig. 4 172 mm
26-282-15	Fig. 5 172 mm
26-282-16	Fig. 6 182 mm
26-282-17	Fig. 7 222 mm



Fig. 1 | Ø 11 mm
26-282-11

für Kleinkinder
 for infants
 para bebés
 per noenati



Fig. 2 | Ø 11 mm
26-282-12

für Kinder
 for children
 para niños
 per bambini



Fig. 3 | Ø 12 mm
26-282-13

für Erwachsene
 for adults
 para adultos
 per adulti



Fig. 4 | Ø 14 mm
26-282-14

für Erwachsene
 for adults
 para adultos
 per adulti



Fig. 5 | Ø 16 mm
26-282-15

für Erwachsene
 for adults
 para adultos
 per adulti

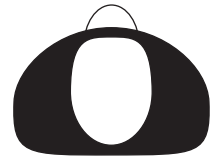

Fig. 6 | 13x18 mm
26-282-16

für Erwachsene
 for adults
 para adultos
 per adulti



Fig. 7 | 13x18 mm
26-282-17

für Erwachsene
 for adults
 para adultos
 per adulti



mit festem Rauchabsaugrohr
 with fixed vapor suction tube
 con cánula de aspiración para vapor
 con cannula d'aspirazione per vapore

26-282-21	Fig. 1 135 mm
26-282-22	Fig. 2 152 mm
26-282-23	Fig. 3 182 mm
26-282-24	Fig. 4 172 mm
26-282-25	Fig. 5 172 mm
26-282-26	Fig. 6 182 mm
26-282-27	Fig. 7 222 mm



Fig. 1 | Ø 11 mm
26-282-21

für Kleinkinder
 for infants
 para bebés
 per noenati



Fig. 2 | Ø 11 mm
26-282-22

für Kinder
 for children
 para niños
 per bambini



Fig. 3 | Ø 12 mm
26-282-23

für Erwachsene
 for adults
 para adultos
 per adulti



Fig. 4 | Ø 14 mm
26-282-24

für Erwachsene
 for adults
 para adultos
 per adulti



Fig. 5 | Ø 16 mm
26-282-25

für Erwachsene
 for adults
 para adultos
 per adulti

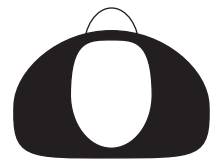

Fig. 6 | 13x18 mm
26-282-26

für Erwachsene
 for adults
 para adultos
 per adulti

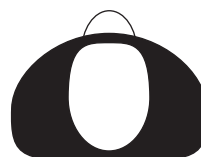

Fig. 7 | 13x18 mm
26-282-27

für Erwachsene
 for adults
 para adultos
 per adulti

Fiberglas-Lichtleiter für Laryngoskope 26-282-01 - 26-282-27
Fibre optic light carrier for laryngoscope 26-282-01 - 26-282-27
Soporte para luz de fibra óptica para laringoscopios 26-282-01 - 26-282-27
Conduttore di luce in fibra di vetro per laringoscopia 26-282-01 - 26-282-27



26-283-01 Fig. 1 - 2

26-283-02 Fig. 3 - 6

26-283-03 Fig. 7

Injektionskanüle für Laryngoskope 26-282-01 - 26-282-27
Injection cannula for laryngoscopes 26-282-01 - 26-282-27
Cánula de inyección para laringoscopia 26-282-01 - 26-282-27
Cannula d'iniezione per laringoscopia 26-282-01 - 26-282-27



26-284-00 Fig. 1 - 7

Rauchabsaugrohr für Laryngoskope 26-282-01 - 26-282-27
Vapor suction tube for laryngoscopes 26-282-01 - 26-282-27
Cánula de aspiración para vapor para laringoscopia 26-282-01 - 26-282-27
Cannula d'aspirazione per vapore per laringoscopia 26-282-01 - 26-282-27



26-285-00 Fig. 3 - 7



mit festem Rauchabsaugrohr
with fixed vapor suction tube
con cánula de aspiración para vapor
con cannula d'aspirazione per vapore

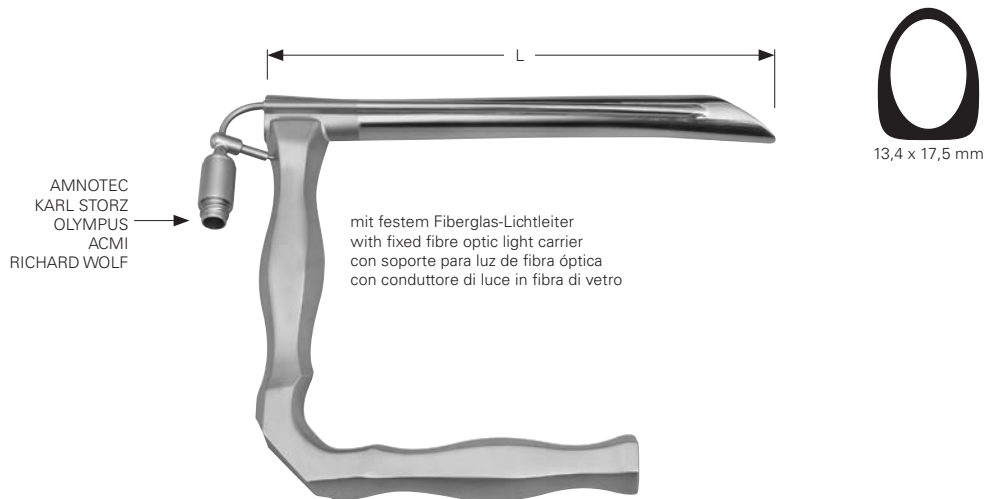

Fig. 7 I Ø 14 mm

26-282-37

für Erwachsene
for adults
para adultos
per adulti

26-282-37 Fig. 7 I 140 mm



HOLINGER

26-286-01	Fig. 1 120 mm
26-286-02	Fig. 2 171 mm
26-286-03	Fig. 3 180 mm



HOLINGER

26-286-11	Fig. 1 120 mm
26-286-12	Fig. 2 171 mm
26-286-13	Fig. 3 180 mm

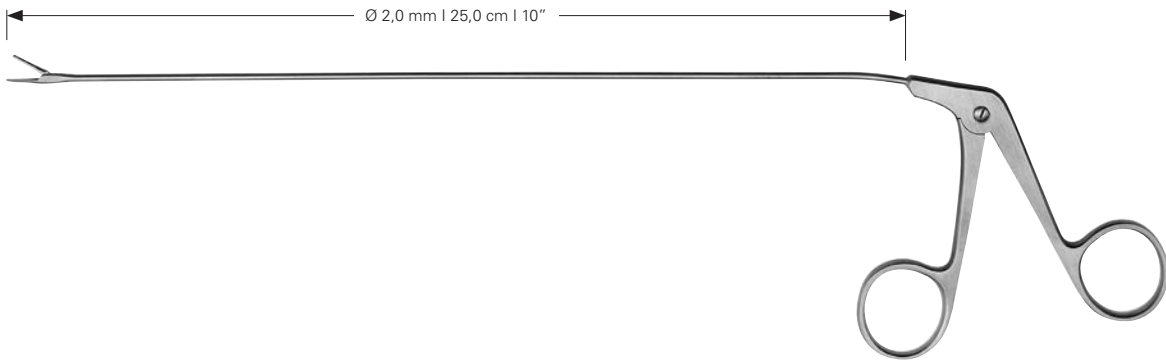

26-290-01

Mikro-Faßzange, gerade
Micro grasping forceps, straight
Micro-pinza de agarre, recta
Micropinze da presa, retto



26-290-04 Ø 2,0 mm

Mikro-Löffelzange, gerade
Micro cup-shaped forceps, straight
Micro-pinza en forma de cucharilla, recta
Micropinze a cucchiaio, retto

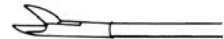

26-290-08

Mikro-Schere, gerade
Micro scissors, straight
Micro-tijeras de agarre, recta
Microforbici da presa, retto



26-290-02

Mikro-Faßzange, links gebogen
Micro grasping forceps, curved left
Micro-pinza de agarre, curva a la izquierda
Micropinze da presa, curvo verso sinistra



26-290-05 Ø 2,0 mm

Mikro-Löffelzange, links gebogen
Micro cup-shaped forceps, curved left
Micro-pinza en forma de cucharilla, curva a la izquierda
Micropinze a cucchiaio, curvo verso sinistra



26-290-09

Mikro-Schere, links gebogen
Micro scissors, curved left
Micro-tijeras de agarre, curva a la izquierda
Microforbici da presa, curvo verso sinistra



26-290-03

Mikro-Faßzange, rechts gebogen
Micro grasping forceps, curved right
Micro-pinza de agarre, curva a la derecha
Micropinze da presa, curvo verso destra

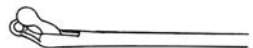

26-290-06 Ø 2,0 mm

Mikro-Löffelzange, rechts gebogen
Micro cup-shaped forceps, curved right
Micro-pinza en forma de cucharilla, curva hacia la derecha
Micropinze a cucchiaio, curvo verso destra



26-290-10

Mikro-Schere, rechts gebogen
Micro scissors, curved right
Micro-tijeras de agarre, curva a la derecha
Microforbici da presa, curvo verso destra



26-290-07 Ø 2,0 mm

Mikro-Löffelzange, aufgebogen
Micro cup-shaped forceps, curved upwards
Micro-pinza en forma de cucharilla, curva hacia arriba
Micropinze a cucchiaio, curvo verso l'alto

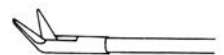

26-290-11

Mikro-Schere, aufgebogen
Micro scissors, curved upwards
Micro-tijeras de agarre, curva hacia arriba
Microforbici da presa, curvo verso l'alto

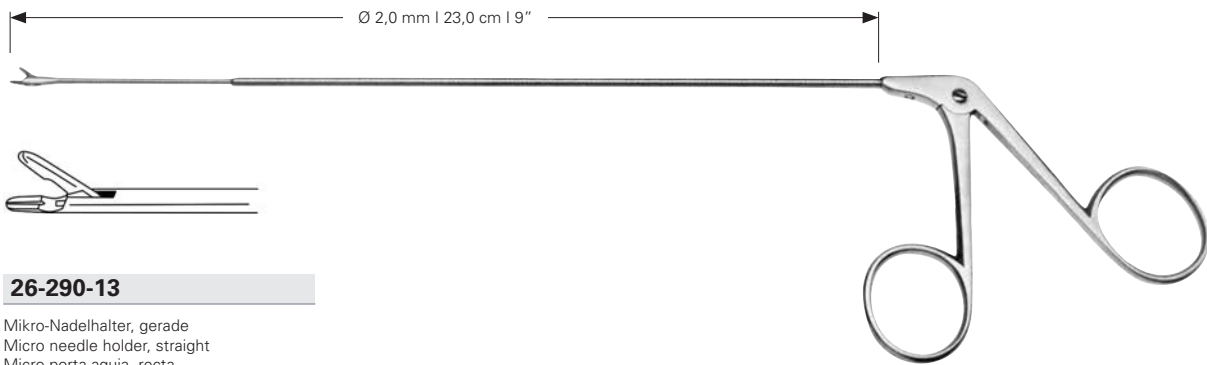

26-290-13

Mikro-Nadelhalter, gerade
 Micro needle holder, straight
 Micro-porta-aguja, recta
 Microportaghi, retto

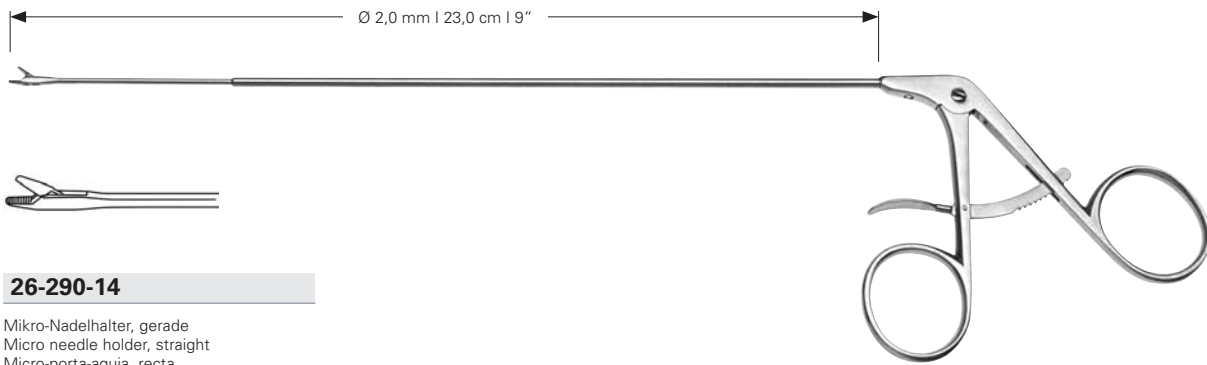

26-290-14

Mikro-Nadelhalter, gerade
 Micro needle holder, straight
 Micro-porta-aguja, recta
 Microportaghi, retto

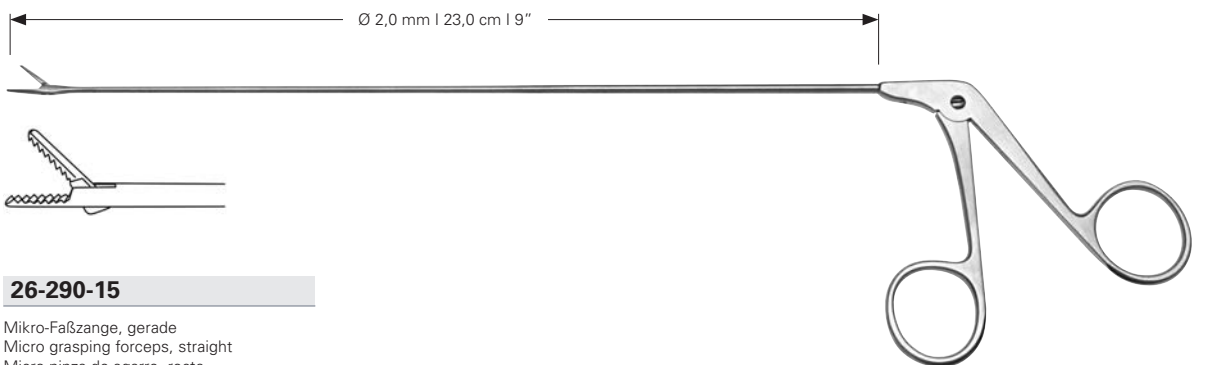

26-290-15

Mikro-Faßzange, gerade
 Micro grasping forceps, straight
 Micro-pinza de agarre, recta
 Micropinze da presa, retto

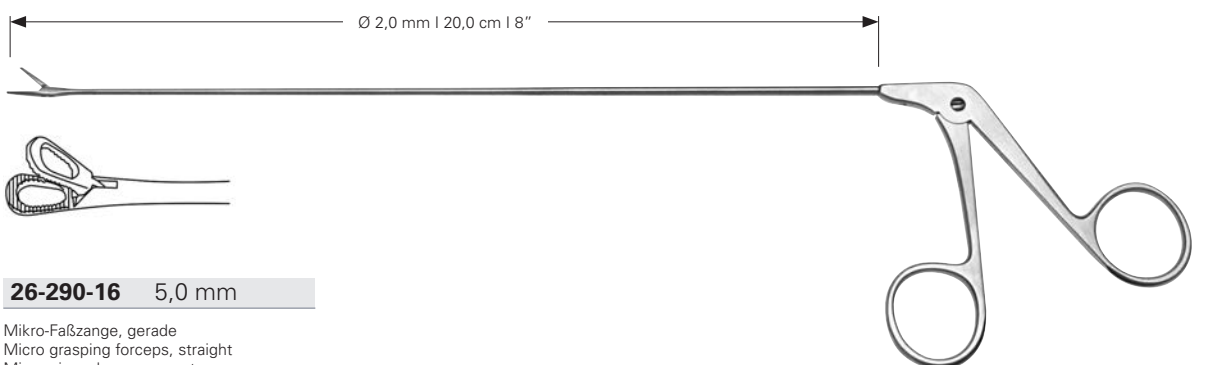

26-290-16 5,0 mm

Mikro-Faßzange, gerade
 Micro grasping forceps, straight
 Micro-pinza de agarre, recta
 Micropinze da presa, retto

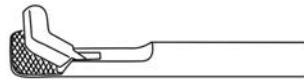
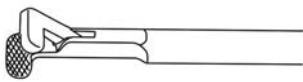
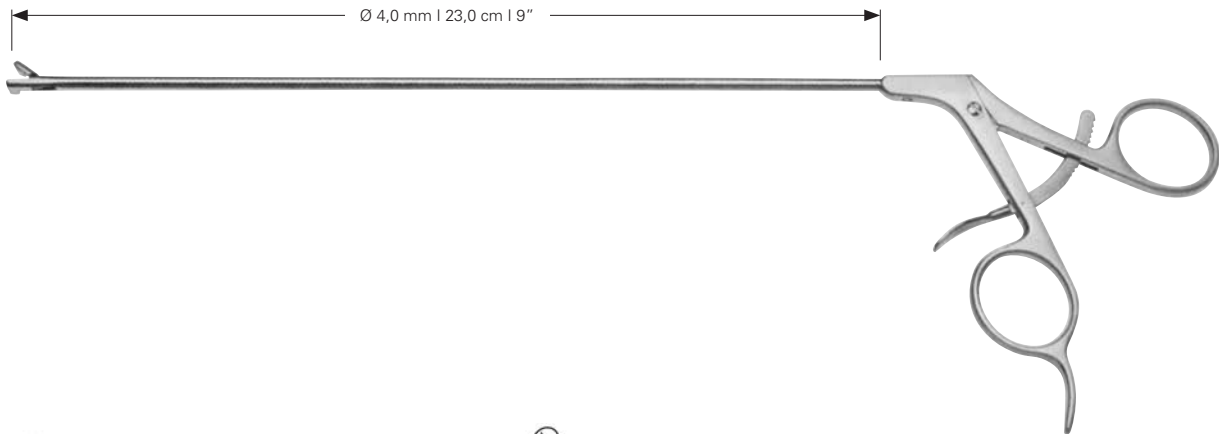

26-290-17 90°

Mikro-Nadelhalter, links gebogen
Micro needle holder, curved left
Micro-porta-aguja, curva a la izquierda
Microportaghi, curvo verso sinistra

26-290-18 90°

Mikro-Nadelhalter, rechts gebogen
Micro needle holder, curved right
Micro-porta-aguja, curva a la derecha
Microportaghi, curvo verso destra

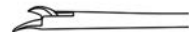
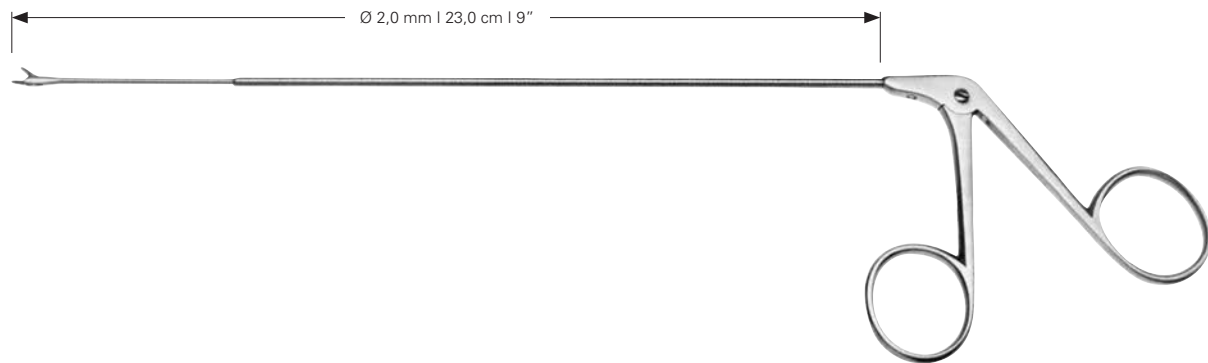

26-290-20

Mikro-Schere, gerade
Micro scissors, straight
Micro-tijeras de agarre, recta
Microforbici da presa, retto

26-290-21 15°

26-290-22 45°

Mikro-Schere, aufgebogen
Micro scissors, curved upwards
Micro-tijeras de agarre, curva hacia arriba
Microforbici da presa, curvo verso l'alto

26-290-23

Mikro-Schere, links gebogen
Micro scissors, curved left
Micro-tijeras de agarre, curva a la izquierda
Microforbici da presa, curvo verso sinistra

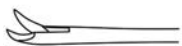

26-290-24

Mikro-Schere, rechts gebogen
Micro scissors, curved right
Micro-tijeras de agarre, curva a la derecha
Microforbici da presa, curvo verso destra

26-290-25

Mikro-Schere, gerade, horizontal öffnend
Micro scissors, straight, horizontal opening
Micro-tijeras de agarre, recta, abertura horizontal
Microforbici da presa, retto, apertura orizzontale

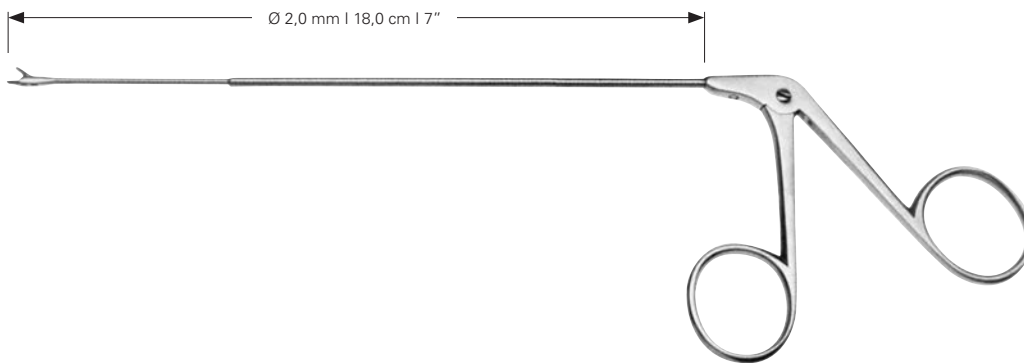

26-290-26

Mikro-Schere, gerade
 Micro scissors, straight
 Micro-tijeras de agarre, recta
 Microforbici da presa, retto



26-290-27 45°

Mikro-Schere, aufgebogen
 Micro scissors, curved upwards
 Micro-tijeras de agarre, curva hacia arriba
 Microforbici da presa, curvo verso l'alto



26-290-34

Mikro-Schere, links gebogen
 Micro scissors, curved left
 Micro-tijeras de agarre, curva a la izquierda
 Microforbici da presa, curvo verso sinistra



26-290-35

Mikro-Schere, rechts gebogen
 Micro scissors, curved right
 Micro-tijeras de agarre, curva a la derecha
 Microforbici da presa, curvo verso destra

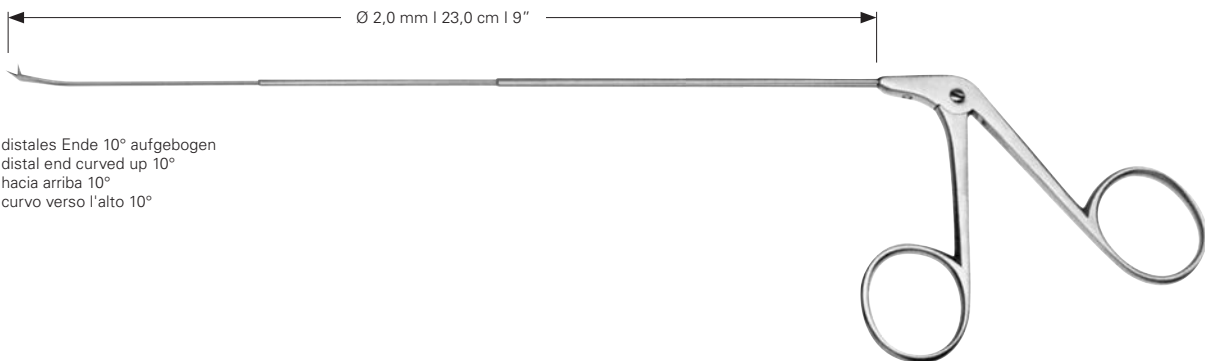

distales Ende 10° aufgebogen
 distal end curved up 10°
 hacia arriba 10°
 curvo verso l'alto 10°



26-290-30

Mikro-Schere, gerade
 Micro scissors, straight
 Micro-tijeras de agarre, recta
 Microforbici da presa, retto



26-290-31 45°

Mikro-Schere, aufgebogen
 Micro scissors, curved upwards
 Micro-tijeras de agarre, curva hacia arriba
 Microforbici da presa, curvo verso l'alto



26-290-32

Mikro-Schere, links gebogen
 Micro scissors, curved left
 Micro-tijeras de agarre, curva a la izquierda
 Microforbici da presa, curvo verso sinistra



26-290-33

Mikro-Schere, rechts gebogen
 Micro scissors, curved right
 Micro-tijeras de agarre, curva a la derecha
 Microforbici da presa, curvo verso destra

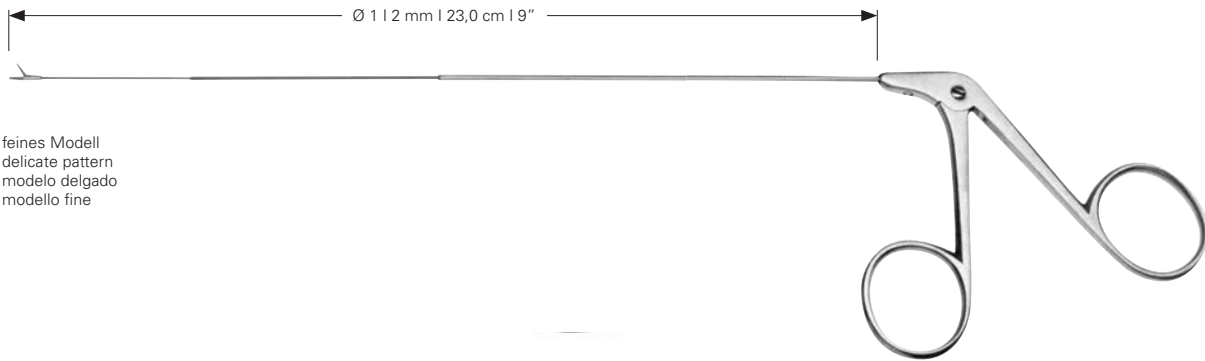

feines Modell
delicate pattern
modelo delgado
modello fine



26-290-40

Mikro-Schere, gerade
Micro scissors, straight
Micro-tijeras de agarre, recta
Microforbici da presa, retto



26-290-41 45°

Mikro-Schere, aufgebogen
Micro scissors, curved upwards
Micro-tijeras de agarre, curva hacia arriba
Microforbici da presa, curvo verso l'alto



26-290-42

Mikro-Schere, links gebogen
Micro scissors, curved left
Micro-tijeras de agarre, curva a la izquierda
Microforbici da presa, curvo verso sinistra



26-290-43

Mikro-Schere, rechts gebogen
Micro scissors, curved right
Micro-tijeras de agarre, curva a la derecha
Microforbici da presa, curvo verso destra

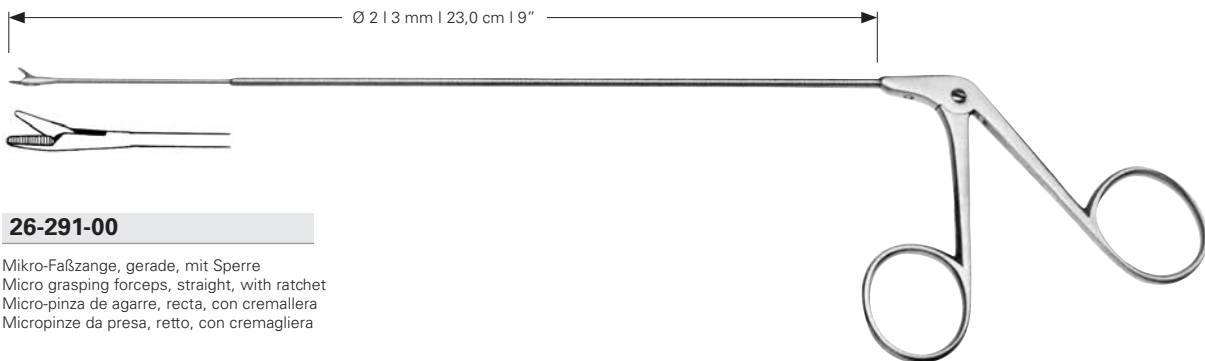

26-291-00

Mikro-Faßzange, gerade, mit Sperre
Micro grasping forceps, straight, with ratchet
Micro-pinza de agarre, recta, con cremallera
Micropinze da presa, retto, con cremagliera



26-291-01

Mikro-Faßzange, gerade
Micro grasping forceps, straight
Micro-pinza de agarre, recta
Micropinze da presa, retto



26-291-02

Mikro-Faßzange, links gebogen
Micro grasping forceps, curved left
Micro-pinza de agarre, curva a la izquierda
Micropinze da presa, curvo verso sinistra



26-291-03

Mikro-Faßzange, rechts gebogen
Micro grasping forceps, curved right
Micro-pinza de agarre, curva a la derecha
Micropinze da presa, curvo verso destra



26-291-11

Mikro-Faßzange, aufgebogen
Micro grasping forceps, curved upwards
Micro-pinza de agarre, curva hacia arriba
Micropinze da presa, curvo verso l'alto



26-291-12

Mikro-Faßzange, links aufgebogen
Micro grasping forceps, curved up left
Micro-pinza de agarre, hacia arriba izquierda
Micropinze da presa, curve verso l'alto sinistra



26-291-13

Mikro-Faßzange, rechts aufgebogen
Micro grasping forceps, curved up right
Micro-pinza de agarre, hacia arriba derecha
Micropinze da presa, curve verso l'alto destra

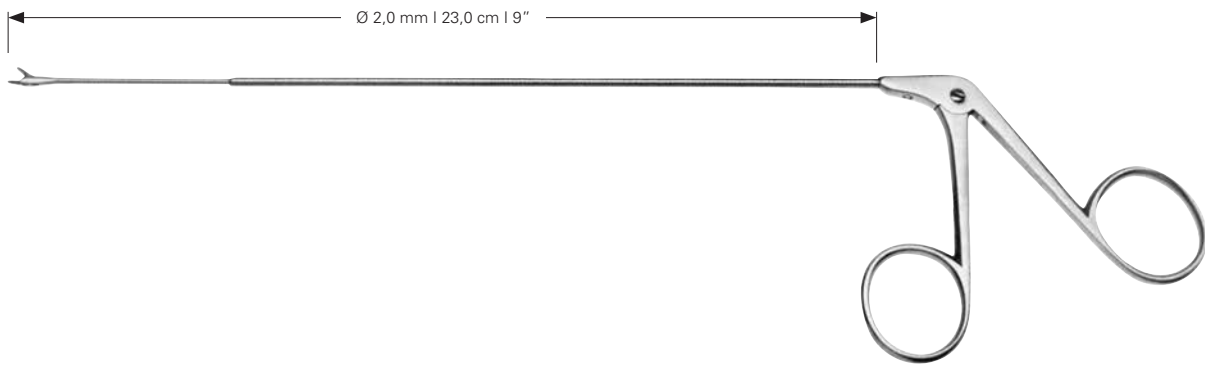

26-291-20 Ø 2,0 mm

Mikro-Löffelzange, gerade
 Micro cup-shaped forceps, straight
 Micro-pinza en forma de cucharilla, recta
 Micropinze a cucchiaio, retto



26-291-21 Ø 2,0 mm

Mikro-Löffelzange, aufgebogen
 Micro cup-shaped forceps, curved upwards
 Micro-pinza en forma de cucharilla, curva hacia arriba
 Micropinze a cucchiaio, curvo verso l'alto



26-291-22 Ø 2,0 mm

Mikro-Löffelzange, links gebogen
 Micro cup-shaped forceps, curved left
 Micro-pinza en forma de cucharilla, curva a la izquierda
 Micropinze a cucchiaio, curvo verso sinistra



26-291-23 Ø 2,0 mm

Mikro-Löffelzange, rechts gebogen
 Micro cup-shaped forceps, curved right
 Micro-pinza en forma de cucharilla, curva a la derecha
 Micropinze a cucchiaio, curvo verso destra



26-291-32 Ø 2,0 mm

Mikro-Löffelzange, links aufgebogen
 Micro cup-shaped forceps, curved up left
 Micro-pinza en forma de cucharilla, hacia arriba izquierda
 Micropinze a cucchiaio, curve verso l'alto sinistra



26-291-33 Ø 2,0 mm

Mikro-Löffelzange, rechts aufgebogen
 Micro cup-shaped forceps, curved up right
 Micro-pinza en forma de cucharilla, hacia arriba derecha
 Micropinze a cucchiaio, curve verso l'alto destra



26-291-34 2,0 x 2,0 mm

Mikro-Löffelzange, links aufgebogen
 Micro cup-shaped forceps, curved up left
 Micro-pinza en forma de cucharilla, hacia arriba izquierda
 Micropinze a cucchiaio, curve verso l'alto sinistra



26-291-35 2,0 x 2,0 mm

Mikro-Löffelzange, rechts aufgebogen
 Micro cup-shaped forceps, curved up right
 Micro-pinza en forma de cucharilla, hacia arriba derecha
 Micropinze a cucchiaio, curve verso l'alto destra



26-291-42 Ø 2,0 mm

Mikro-Löffelzange, horizontal, links
 Micro cup-shaped forceps, horizontal, left
 Micro-pinza en forma de cucharilla, horizontal, izquierda
 Micropinze a cucchiaio, orizzontale, sinistra



26-291-43 Ø 2,0 mm

Mikro-Löffelzange, horizontal, rechts
 Micro cup-shaped forceps, horizontal, right
 Micro-pinza en forma de cucharilla, horizontal, derecha
 Micropinze a cucchiaio, orizzontale, destra

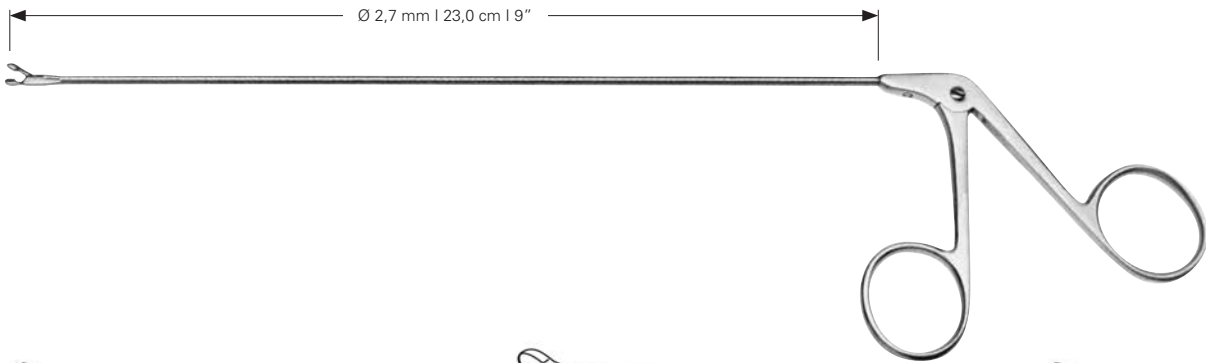

26-291-44 3,0 x 4,0 mm

Mikro-Löffelzange, gerade, kräftiges Modell
Micro cup-shaped forceps, straight, heavy pattern
Micro-pinza en forma de cucharilla, recta, modelo fornido
Micropinze a cucchiaio, retto, modello forte

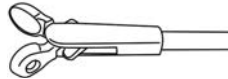

26-291-45 Ø 4,0 mm

Mikro-Löffelzange, gerade
Micro cup-shaped forceps, straight
Micro-pinza en forma de cucharilla, recta
Micropinze a cucchiaio, retto



26-291-50 Ø 4,0 mm

Mikro-Löffelzange, gerade
Micro cup-shaped forceps, straight
Micro-pinza en forma de cucharilla, recta
Micropinze a cucchiaio, retto



26-291-51 Ø 4,0 mm

Mikro-Löffelzange, aufgebogen
Micro cup-shaped forceps, curved upwards
Micro-pinza en forma de cucharilla, curva hacia arriba
Micropinze a cucchiaio, curvo verso l'alto



26-291-52 Ø 4,0 mm

Mikro-Löffelzange, links aufgebogen
Micro cup-shaped forceps, curved up left
Micro-pinza en forma de cucharilla, curva hacia izquierda
Micropinze a cucchiaio, curve verso l'alto sinistra



26-291-53 Ø 4,0 mm

Mikro-Löffelzange, rechts gebogen
Micro cup-shaped forceps, curved right
Micro-pinza en forma de cucharilla, curva a la derecha
Micropinze a cucchiaio, curvo verso destra

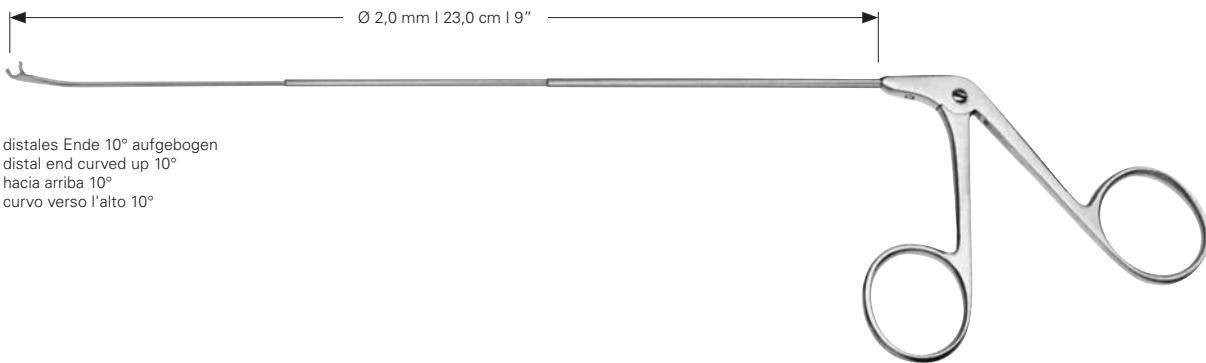

26-291-60 Ø 2,0 mm

Mikro-Löffelzange, gerade
Micro cup-shaped forceps, straight
Micro-pinza en forma de cucharilla, recta
Micropinze a cucchiaio, retto



26-291-61 Ø 2,0 mm

Mikro-Löffelzange, aufgebogen
Micro cup-shaped forceps, curved upwards
Micro-pinza en forma de cucharilla, curva hacia arriba
Micropinze a cucchiaio, curvo verso l'alto



26-291-62 Ø 2,0 mm

Mikro-Löffelzange, links gebogen
Micro cup-shaped forceps, curved left
Micro-pinza en forma de cucharilla, curva a la izquierda
Micropinze a cucchiaio, curvo verso sinistra



26-291-63 Ø 2,0 mm

Mikro-Löffelzange, rechts gebogen
Micro cup-shaped forceps, curved right
Micro-pinza en forma de cucharilla, curva a la derecha
Micropinze a cucchiaio, curvo verso destra

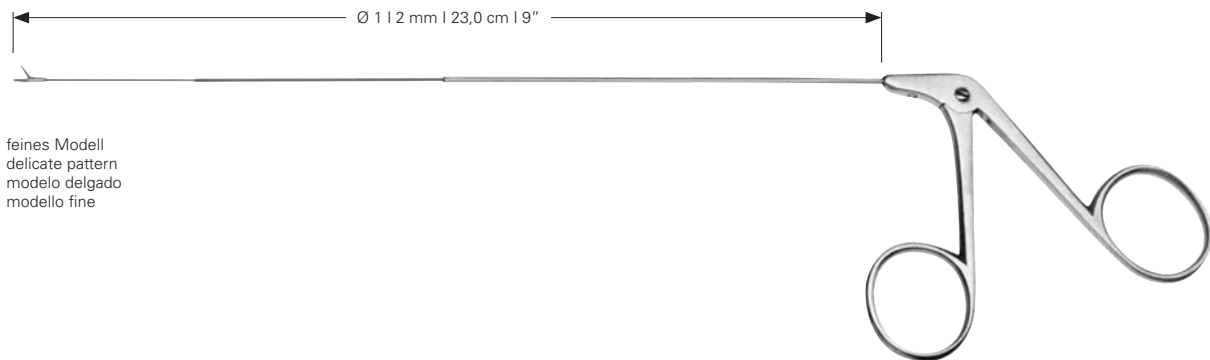

feines Modell
delicate pattern
modelo delgado
modello fine



26-292-01

Mikro-Faßzange, gerade
Micro grasping forceps, straight
Micro-pinza de agarre, recta
Micropinze da presa, retto



26-292-02

Mikro-Faßzange, links gebogen
Micro grasping forceps, curved left
Micro-pinza de agarre, curva a la izquierda
Micropinze da presa, curvo verso sinistra



26-292-03

Mikro-Faßzange, rechts gebogen
Micro grasping forceps, curved right
Micro-pinza de agarre, curva a la derecha
Micropinze da presa, curvo verso destra



26-292-11

Mikro-Faßzange, aufgebogen
Micro grasping forceps, curved upwards
Micro-pinza de agarre, curva hacia arriba
Micropinze da presa, curvo verso l'alto

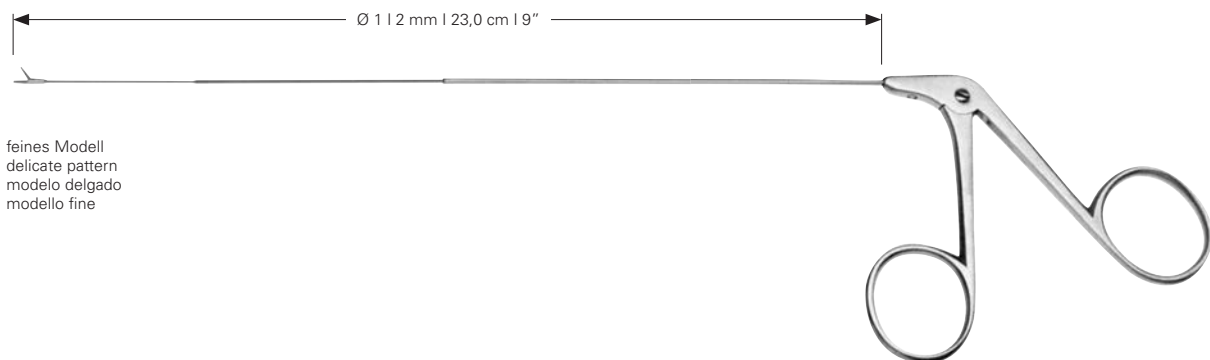

feines Modell
delicate pattern
modelo delgado
modello fine



26-292-20 Ø 1,0 mm

Mikro-Löffelzange, gerade
Micro cup-shaped forceps, straight
Micro-pinza en forma de cucharilla, recta
Micropinze a cucchiaio, retto



26-292-21 Ø 1,0 mm

Mikro-Löffelzange, aufgebogen
Micro cup-shaped forceps, curved upwards
Micro-pinza en forma de cucharilla, curva hacia arriba
Micropinze a cucchiaio, curvo verso l'alto



26-292-22 Ø 1,0 mm

Mikro-Löffelzange, links gebogen
Micro cup-shaped forceps, curved left
Micro-pinza en forma de cucharilla, curva a la izquierda
Micropinze a cucchiaio, curvo verso sinistra



26-292-23 Ø 1,0 mm

Mikro-Löffelzange, rechts gebogen
Micro cup-shaped forceps, curved right
Micro-pinza en forma de cucharilla, curva a la derecha
Micropinze a cucchiaio, curvo verso destra



26-292-32 Ø 1,0 mm

Mikro-Löffelzange, links aufgebogen
Micro cup-shaped forceps, curved up left
Micro-pinza en forma de cucharilla, hacia arriba izquierda
Micropinze a cucchiaio, curve verso l'alto sinistra



26-292-33 Ø 1,0 mm

Mikro-Löffelzange, rechts aufgebogen
Micro cup-shaped forceps, curved up right
Micro-pinza en forma de cucharilla, hacia arriba derecha
Micropinze a cucchiaio, curve verso l'alto destra

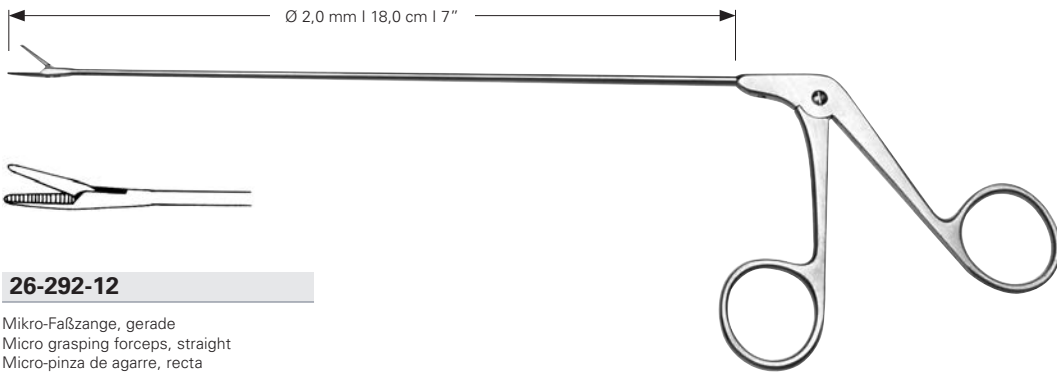

26-292-12

Mikro-Faßzange, gerade
Micro grasping forceps, straight
Micro-pinza de agarre, recta
Micropinze da presa, retto

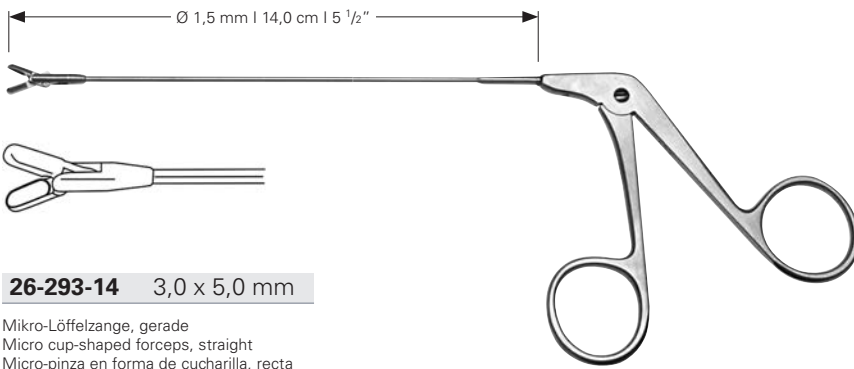

26-293-14 3,0 x 5,0 mm

Mikro-Löffelzange, gerade
Micro cup-shaped forceps, straight
Micro-pinza en forma de cucharilla, recta
Micropinze a cucchiaio, retto

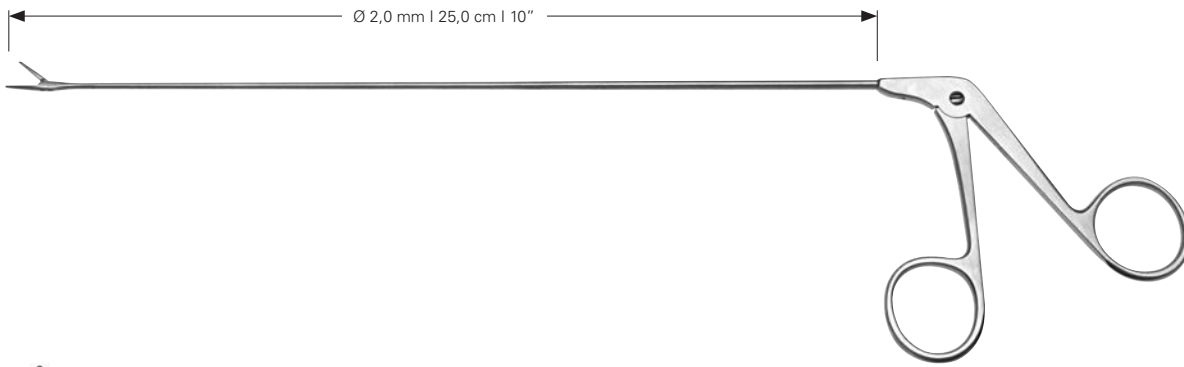

26-294-01 2,0 x 3,0 mm

Mikro-Löffelzange, gerade
Micro cup-shaped forceps, straight
Micro-pinza en forma de cucharilla, recta
Micropinze a cucchiaio, retto



26-294-02

Mikro-Zange, oval, gerade
Micro forceps, oval, straight
Micro-pinza, ovale, recta
Micropinze, ovale, retto

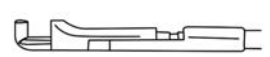

26-294-03 90°

Mikro-Stanze, gerade
Micro punch, straight
Micro-pinza, recta
Micropinze, retto

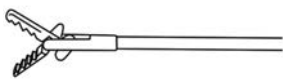
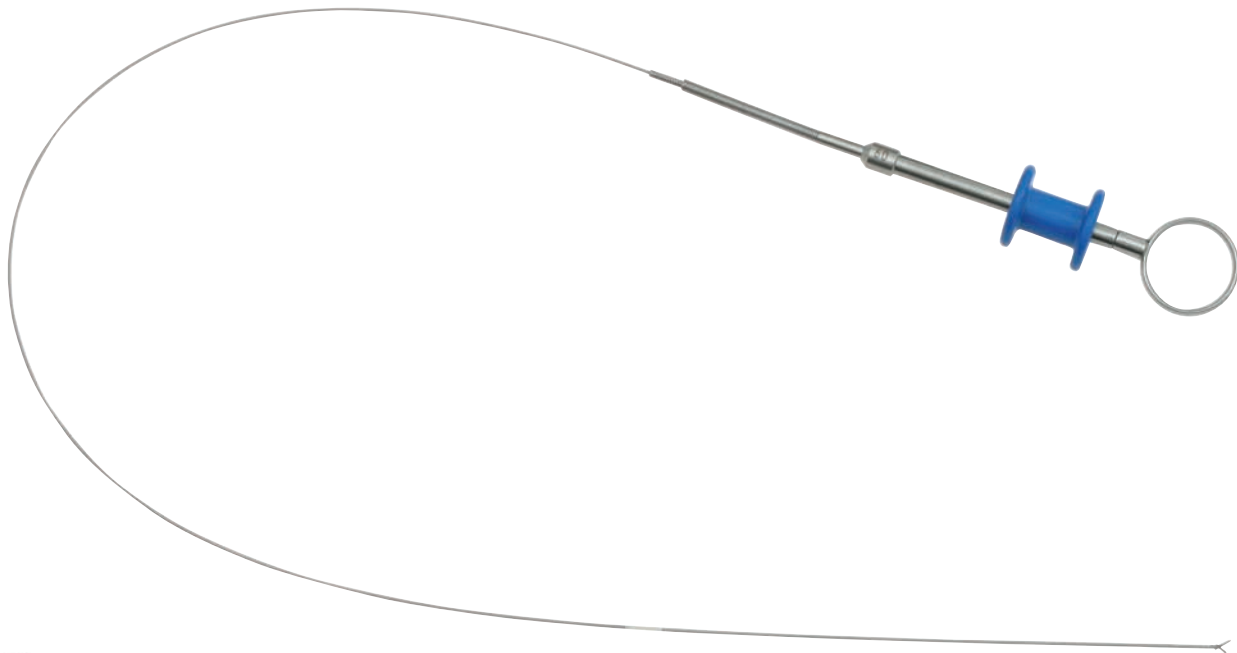

26-295-01 Ø 1,0 x 120 cm

Mikro-Faßzange, gerade
 Micro grasping forceps, straight
 Micro-pinza de agarre, recta
 Micropinze da presa, retto



26-295-02 Ø 1,0 x 120 cm

Mikro-Löffelzange, gerade
 Micro cup-shaped forceps, straight
 Micro-pinza en forma de cucharilla, recta
 Micropinze a cucchiaio, retto

Andere Modelle auf Anfrage
 Other patterns on request
 Otro modelo a consulta
 Altri modelli su domanda

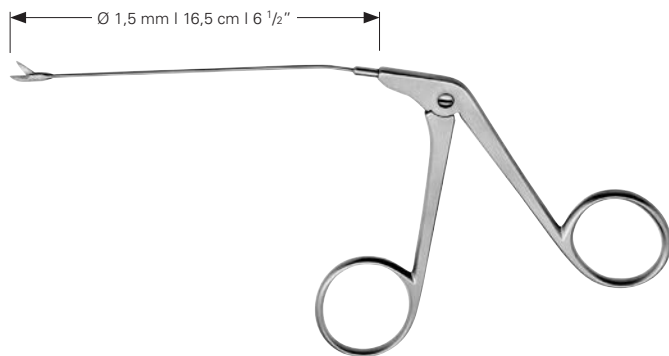

FAHLBUSCH

26-296-00

Mikro-Schere, horizontal öffnend
 Micro scissors, horizontal opening
 Micro-tijeras de agarre, abertura horizontal
 Microforbici da presa, apertura orizzontale



NICOLA

26-296-01 Ø 2,5 mm

Mikro-Löffelzange, gerade
 Micro cup-shaped forceps, straight
 Micro-pinza en forma de cucharilla, recta
 Micropinze a cucchiaio, retto



YASARGIL-NICOLA

26-296-02

Mikro-Faßzange, gerade
 Micro grasping forceps, straight
 Micro-pinza de agarre, recta
 Micropinze da presa, retto



NICOLA

26-296-03

Mikro-Schere, gerade
 Micro scissors, straight
 Micro-tijeras de agarre, recta
 Microforbici da presa, retto



Laryngealschnürer
Laryngeal snare
Cierra-nudos para laringología
Serranodi per laringologia

26-297-05



Verpackungseinheit: 12 St.
Packing unit: 12 pieces
Unidad: 12 piezas
Confezione: 12 pezzi

Schnürdrähte
Snare wires
Alambre para amigdalótomo
Filo per serranodi



26-297-99 Ø 0,3 mm

Handgriff für Stabinstrumente
Handle for Laryngeal instruments
Mango para instrumentos laringeal
Manico per strumenti laringeal



26-298-00 10,0 cm, 4 "



26-298-01 24,0 cm, 9 1/2 "

Sichelmesser
Sickle knife
Bisturi falciforme
Bisturi a falce



26-298-02 24,0 cm, 9 1/2 "

Rundmesser
Round edge knife
Cuchillo redondo
Bisturi circolare



26-298-03 24,0 cm, 9 1/2 "

Rundmesser
Round edge knife
Cuchillo redondo
Bisturi circolare



26-298-04 24,0 cm, 9 1/2 "

Rundmesser, 45°
Round edge knife, 45°
Cuchillo redondo, 45°
Bisturi circolare, 45°



26-298-05 24,0 cm, 9 1/2 "

Larynxhaken, 90°
Laryngeal hook, 90°
Gancho laringeo 90°
Uncino per laringe 90°



26-298-06 24,0 cm, 9 1/2 "

Larynxhaken, 30°
Laryngeal hook, 30°
Gancho laringeo 30°
Uncino per laringe 30°



26-298-07 24,0 cm, 9 1/2 "

Larynxhaken
Laryngeal hook
Gancho laringeo
Uncino per laringe



26-298-08 24,0 cm, 9 1/2 "

Fadengabel
Ligature guide
Guía de la sutura
Guida del suturare



26-298-09 24,0 cm, 9 1/2 "

Knotenführer
Knot pusher
Empujador del nudo
Spingitoio del nodo

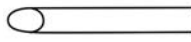

26-298-10 24,0 cm, 9 1/2 "

Saugraspatorium
Suction raspatory
Succion raspatory
Aspirazione raspatory



26-298-11 24,0 cm, 9 1/2 "

Umstechungsnadel rechts
Tonsil ligature needle, right
Aguja de la sutura de la amigdala, derecha
Ago del suturare della tonsilla, destra



26-298-12 24,0 cm, 9 1/2 "

Umstechungsnadel links
Tonsil ligature needle, left
Aguja de la sutura de la amigdala, izquierdo
Ago del suturare della tonsilla, sinistra

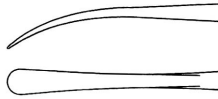

26-298-13 24,0 cm, 9 1/2 "

Elevatorium, stumpf
Elevator, blunt
Elevador, romo
Elevatore, smusso



26-298-21 24,0 cm, 9 1/2 "

Larynxmesser
Laryngeal knife
Bisturi laríngeo
Bisturi per laringe



26-298-22 24,0 cm, 9 1/2 "

Larynxmesser
Laryngeal knife
Bisturi laríngeo
Bisturi per laringe



Watteträger
Cotton applicator
Porta-algodones
Portacotone

26-298-23 28,0 cm, 11 "

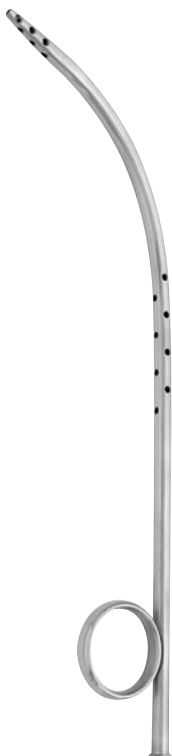

Ø 5,0 mm
26-311-05

Ø 7,0 mm
26-311-07

Ø 9,0 mm
26-311-09

Intubationsrohr
Intubation tube
Tubo del intubation
Tubo di intubazione



26-313-75



26-313-90



Tracheal Trokar
Tracheotomy trocar
Traqueótomo
Trequarto per tracheotomia

MOSHER-BRUENINGS

26-311-05 - 26-311-09 20,0 cm, 8 "

UCKERMANN

26-313-75 - 26-313-90 13,0 cm, 5 1/8 "

Trachealdilatator
Tracheal dilator
Dilatatore traqueales
Dilatatori per tracheotomia



TROUSSEAU

26-315-12 14,0 cm, 5 1/2"

Trachealdilatator
Tracheal dilator
Dilatatore traqueales
Dilatatori per tracheotomia



LABORDE

26-317-12 12,5 cm, 5"

Trachealdilatator
Tracheal dilator
Dilatatore traqueales
Dilatatori per tracheotomia



LABORDE

26-317-13 14,0 cm, 5 1/2"

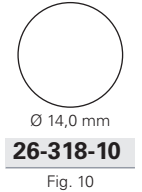
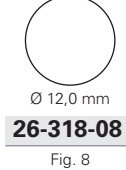
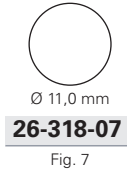
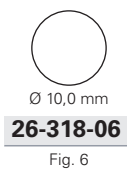
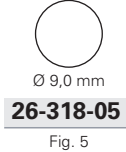
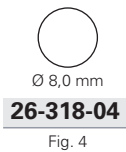
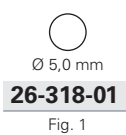

LUER

26-318-00 - 26-318-10

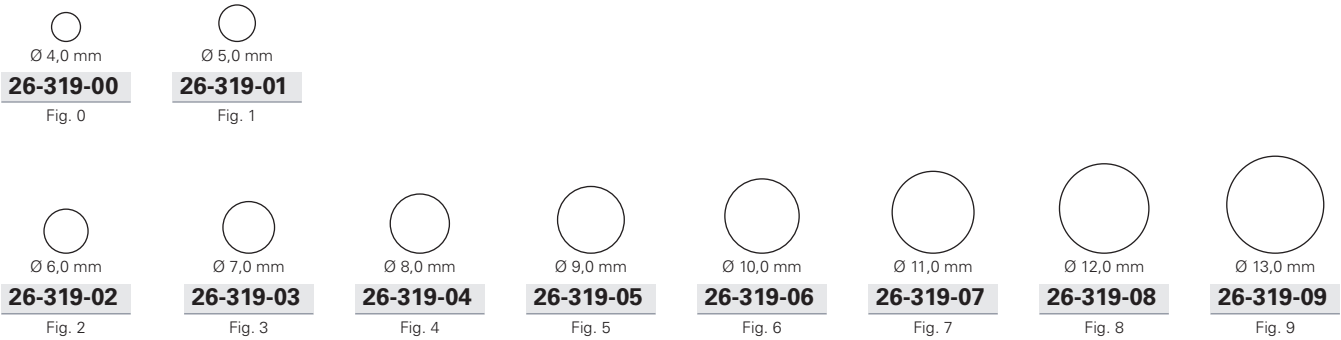

GERMAN
SILVER
NEUSILBER

CHEVALIER-JACKSON

26-319-00 - 26-319-09

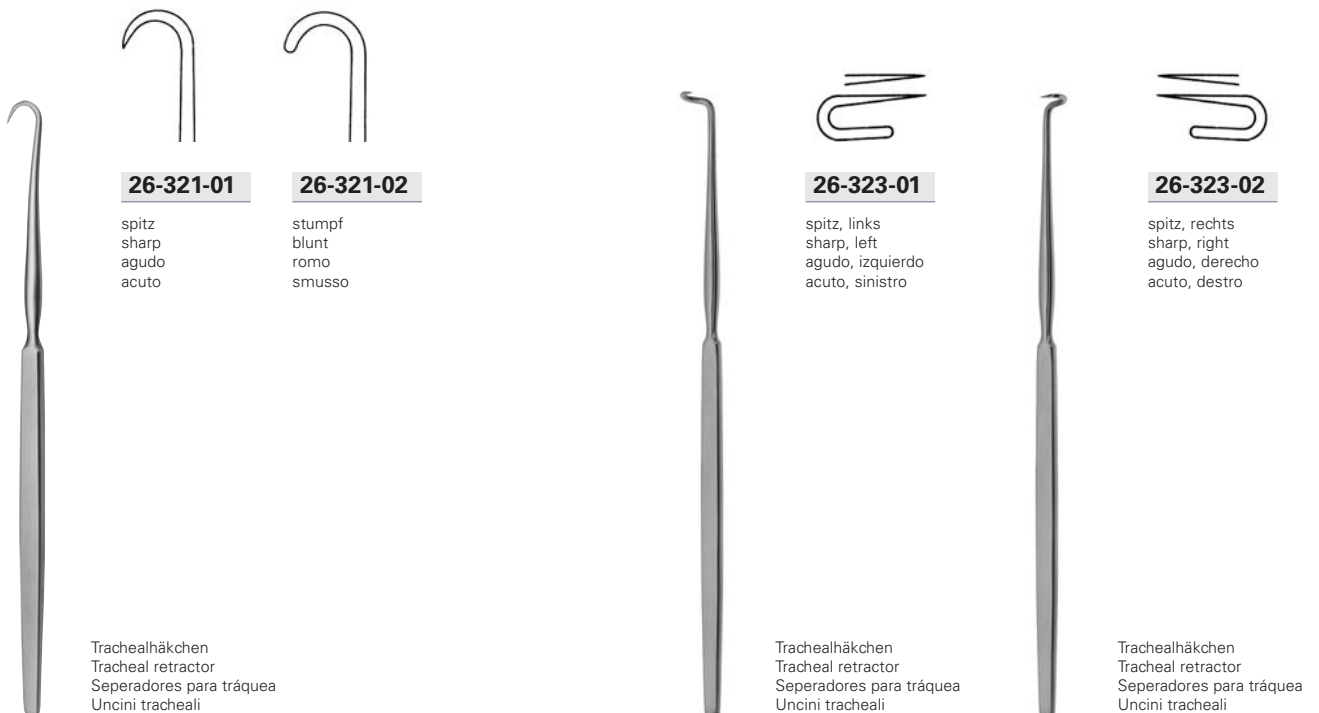

ITERSON

26-321-01 - 26-321-02 16,0 cm, 6 ¼"

BOSE

26-323-01 16,5 cm, 6 ½"

BOSE

26-323-02 16,5 cm, 6 ½"

Trachealhäkchen
Tracheal retractor
Seperadores para tráquea
Uncini tracheali

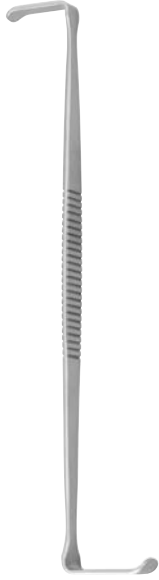

HOUSE

26-325-15 15,0 cm, 6 "

Trachealhäkchen
Tracheal retractor
Seperadores para tráquea
Uncini tracheali



JACKSON

26-329-15 15,0 cm, 6 "



26-331-15



Trachealhäkchen
Tracheal retractor
Seperadores para tráquea
Uncini tracheali

NEWS

26-331-15 15,0 cm, 6 "



26-333-17

Trachealhäkchen
Tracheal retractor
Seperadores para tráquea
Uncini tracheali

LUKENS

26-333-17 17,0 cm, 6 3/4 "

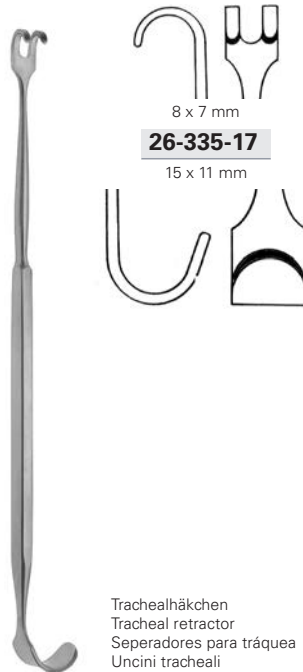

26-335-17

Trachealhäkchen
Tracheal retractor
Seperadores para tráquea
Uncini tracheali

JACKSON

26-335-17 17,0 cm, 6 3/4 "



26-337-21



Trachealhäkchen
Tracheal retractor
Seperadores para tráquea
Uncini tracheali

SCHOENBORN

26-337-21 20,5 cm, 8 "

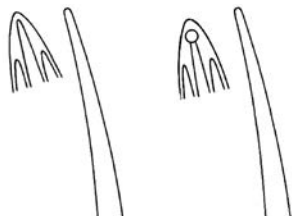

26-339-01

26-339-02

mit Loch
with hole
con el agujero
con il foro



Kropfsonden
Goitre probes
Sonda para bocio
Sonda per gozzo

KOCHER

26-339-01 - 26-339-02 15,0 cm, 6 "

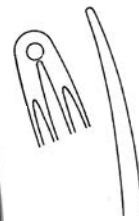

26-339-03

mit Loch
with hole
con el agujero
con il foro



Kropfsonden
Goitre probes
Sonda para bocio
Sonda per gozzo

KOCHER

26-339-03 18,0 cm, 7 "



26-340-15

26-340-20

Kropffasszange
Goitre grasping forceps
Pinze de sugestión para bocio
Pinza da presa per gozzo



LAHEY

26-340-15 15,0 cm, 6 "

26-340-20 20,0 cm, 8 "

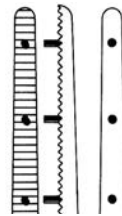

26-341-17

Muskelklemme
Muscular clamp
Pinza-clamp para músculos
Pinza muscolare



MASTIN

26-341-17 17,0 cm, 6 3/4 "



FACE-LIFT

26-345-18 18,0 cm, 7 "

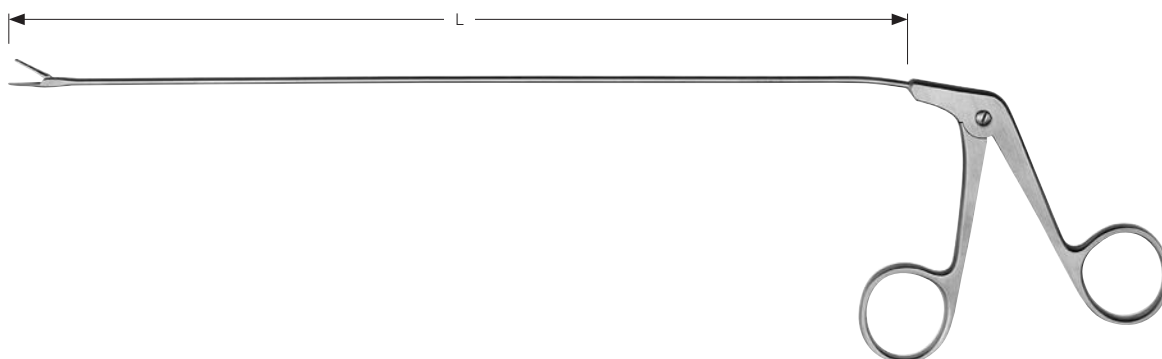

26-400-25	25,0 cm, 9 3/4"
26-400-35	35,0 cm, 13 3/4"
26-400-50	50,0 cm, 20"

Alligatorfaßzange, gerade
Alligator grasping forceps, straight
Pinza de agarre cocodrilo, recta
Pinza alligatore, retto



26-401-25	25,0 cm, 9 3/4"
26-401-35	35,0 cm, 13 3/4"
26-401-50	50,0 cm, 20"

Faßzange, gerade
Grasping forceps, straight
Pinza de agarre, recta
Pinze da presa, retto

Ø 3,0 mm

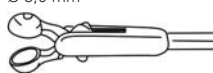

26-402-25	25,0 cm, 9 3/4"
26-402-35	35,0 cm, 13 3/4"
26-402-50	50,0 cm, 20"

Löffelzange, gerade
Cup-shaped forceps, straight
Pinza en forma de cucharilla, recta
Pinze a cucchiaio, retto

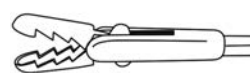

26-403-25	25,0 cm, 9 3/4"
26-403-35	35,0 cm, 13 3/4"
26-403-50	50,0 cm, 20"

Probeexzisionszange, gerade
Biopsy forceps, straight
Pinza para biopsia excisional, recta
Pinza di escissione di prova retto

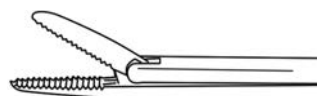
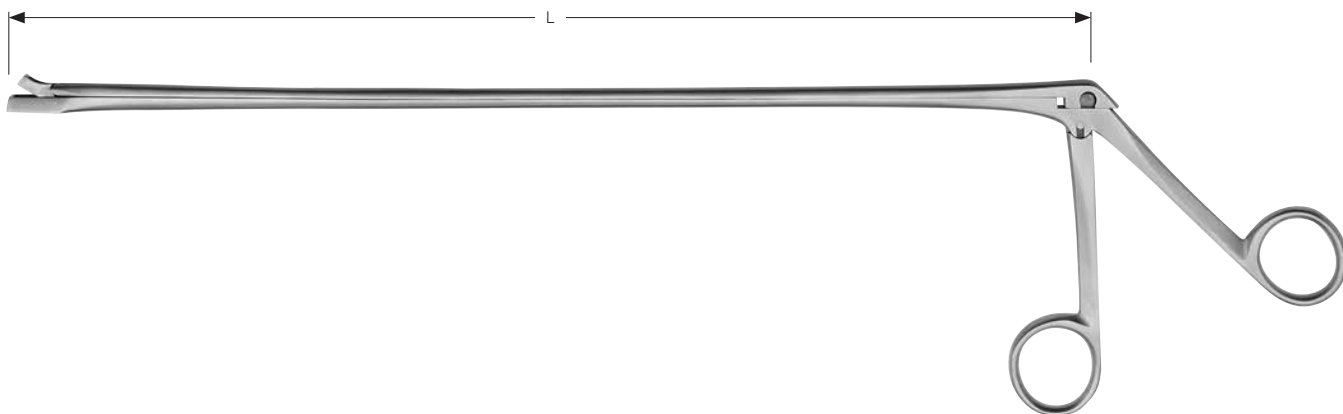

26-417-35	35,0 cm, 13 3/4"
26-417-50	50,0 cm, 20"

Faßzange, gerade
Grasping forceps, straight
Pinza de agarre, recta
Pinza da presa, retto

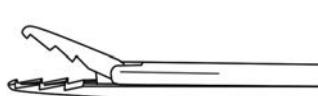

26-418-35	35,0 cm, 13 3/4"
26-418-50	50,0 cm, 20"

Alligatorfaßzange, gerade
Alligator grasping forceps, straight
Pinza de agarre cocodrilo, recta
Pinza alligatore, retto

Ø 6,0 mm



26-419-35	35,0 cm, 13 3/4"
26-419-50	50,0 cm, 20"

Biopsiestanze, gerade
Biopsy punch, straight
Pinza para biopsia, recta
Pinza per biopsia, retto

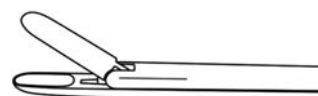

26-420-35	35,0 cm, 13 3/4"
26-420-50	50,0 cm, 20"

Löffelzange, gerade
Cup-shaped forceps, straight
Pinza en forma de cucharilla, recta
Pinze a cucchiaio, retto

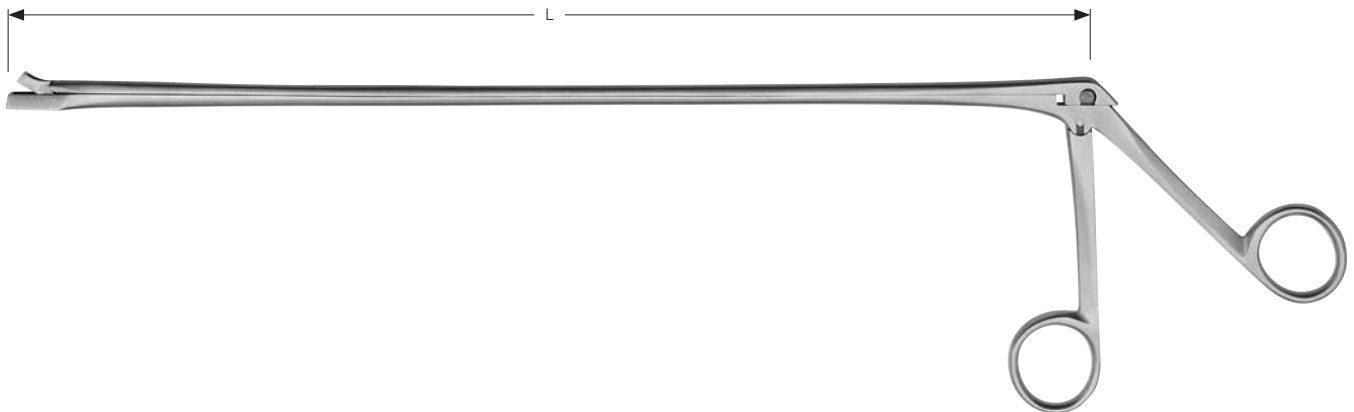

26-410-30	30,0 cm, 12 "
26-410-40	40,0 cm, 16 "
26-410-50	50,0 cm, 20 "
26-410-60	60,0 cm, 24 "

Probeexzisionszange, gerade
Biopsy forceps, straight
Pinza para biopsia excisional, recta
Pinza di escissione di prova retto

26-411-30	30,0 cm, 12 "
26-411-40	40,0 cm, 16 "
26-411-50	50,0 cm, 20 "
26-411-60	60,0 cm, 24 "

Faßzange, gerade
Grasping forceps, straight
Pinza de agarre, recta
Pinza da presa, retto

26-412-30	30,0 cm, 12 "
26-412-40	40,0 cm, 16 "
26-412-50	50,0 cm, 20 "
26-412-60	60,0 cm, 24 "

Alligatorfaßzange, gerade
Alligator grasping forceps, straight
Pinza de agarre cocodrilo, recta
Pinza alligatore, retto

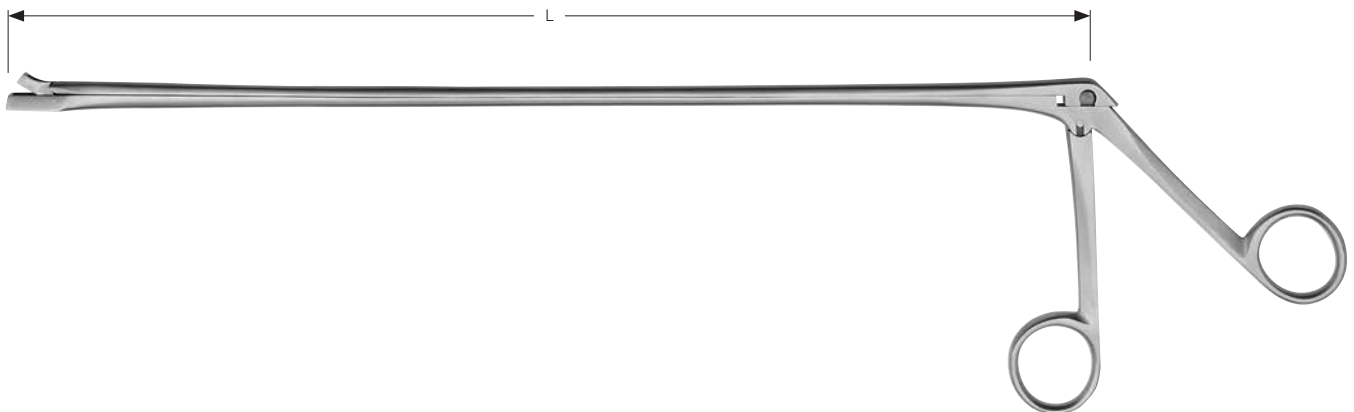

Ø 4,0 mm

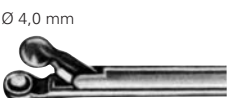

26-413-30	30,0 cm, 12 "
26-413-40	40,0 cm, 16 "
26-413-50	50,0 cm, 20 "
26-413-60	60,0 cm, 24 "

Löffelzange, gerade
Cup-shaped forceps, straight
Pinza en forma de cucharilla, recta
Pinze a cucchiaio, retto

26-414-30	30,0 cm, 12 "
26-414-40	40,0 cm, 16 "
26-414-50	50,0 cm, 20 "
26-414-60	60,0 cm, 24 "

Probeexzisionszange, gerade
Biopsy forceps, straight
Pinza para biopsia excisional, recta
Pinza di escissione di prova retto

26-415-30	30,0 cm, 12 "
26-415-40	40,0 cm, 16 "
26-415-50	50,0 cm, 20 "
26-415-60	60,0 cm, 24 "

Löffelzange, gerade
Cup-shaped forceps, straight
Pinza en forma de cucharilla, recta
Pinze a cucchiaio, retto

26-416-30	30,0 cm, 12 "
26-416-40	40,0 cm, 16 "
26-416-50	50,0 cm, 20 "
26-416-60	60,0 cm, 24 "

Löffelzange, aufgebogen
Cup-shaped forceps, curved upwards
Pinza en forma de cucharilla, curva hacia arriba
Pinze a cucchiaio, curvo verso l'alto



Fig. 1

26-500-08



Fig. 2

26-500-09



Fig. 3

26-500-12



Fig. 4

26-500-15



Fig. 5

26-500-16



Fig. 6

26-500-18

selbsthaltend
self-retaining
autostático
autostatico

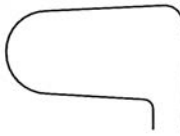

Fig. 7

26-500-19

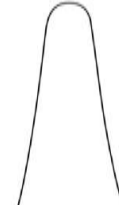

Fig. 1

26-504-01



Fig. 2

26-504-02

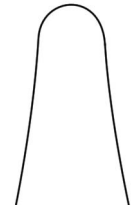

Fig. 3

26-504-03



selbsthaltend, Spreizung durch Stellschraube einstellbar
self-retaining, spread adjustable by set screw
autostático, abertura regulable mediante tornillo de ajuste
autostatico, apertura regolabile mediante vite

THUDICHUM

26-500-08 - 26-500-19 6,5 cm, 2 1/2"

VOLTOLINI

26-504-01 - 26-504-03



Fig. 1

26-506-01

für Säuglinge
for infants
para lactantes
per neonati



Fig. 2

26-506-02

für Kleinkinder
for babies
para niños
per bambini



mit aseptischem Verschluss (zerlegbar)
with aseptic joint (dismantable)
con articulación aséptica (desmontable)
con articolazione aseptica (smontabile)



Fig. 2

26-506-22

für Kleinkinder
for babies
para niños
per bambini



mit aseptischem Verschluss (zerlegbar)
with aseptic joint (dismantable)
con articulación aséptica (desmontable)
con articolazione aseptica (smontabile)

TIECK-HALLE

26-506-01 - 26-506-02 13,5 cm, 5 1/4"

TIECK-HALLE

26-506-22 13,5 cm, 5 1/4"



Fig. 1

26-507-01

für Säuglinge
 for infants
 para lactantes
 per neonati



Fig. 2

26-507-02

für Kleinkinder
 for babies
 para niños
 per bambini



mit Schraubschluß
 with screw joint
 con articulación de tornillo
 con articolazione a vite

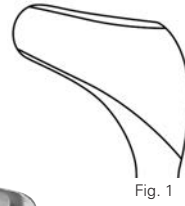

Fig. 1

26-508-01

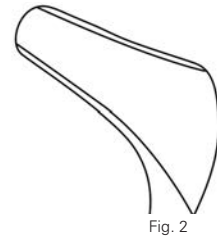

Fig. 2

26-508-02

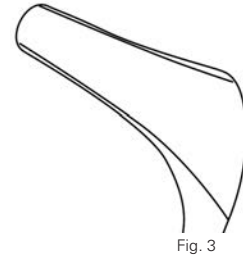

Fig. 3

26-508-03



mit aseptischem Verschuß (zerlegbar)
 with aseptic joint (dismantable)
 con articulación aséptica (desmontable)
 con articolazione asettica (smontabile)

TIECK-HALLE

26-507-01 - 26-507-02 13,5 cm, 5 ¼"

HARTMANN-HALLE

26-508-01 - 26-508-03 15,5 cm, 6 ⅛"

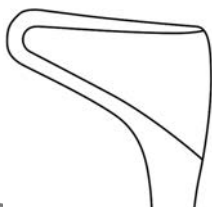

Fig. 1

26-509-01

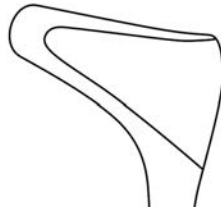

Fig. 2

26-509-02



mit Schraubschluß
 with screw joint
 con articulación de tornillo
 con articolazione a vite

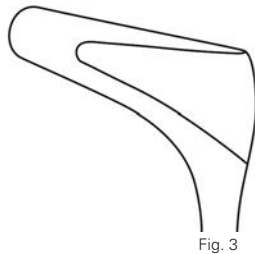

Fig. 3

26-509-03



Fig. 1

26-513-01

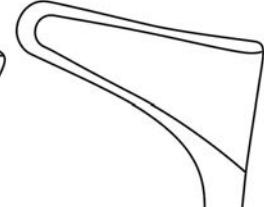

Fig. 2

26-513-02



mit Schraubschluß
 with screw joint
 con articulación de tornillo
 con articolazione a vite

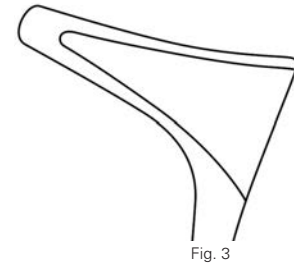

Fig. 3

26-513-03

HARTMANN-HALLE

26-509-01 - 26-509-03 15,5 cm, 6 ⅛"

HARTMANN

26-513-01 - 26-513-03 16,0 cm, 6 ¼"

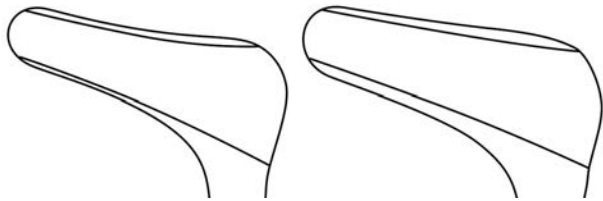

Fig. 1

26-515-01

Fig. 2

26-515-02

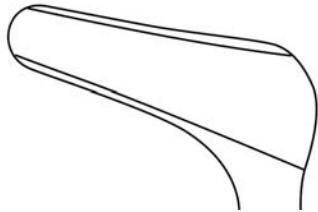

Fig. 3

26-515-03

mit Schraubschluß
with screw joint
con articulación de tornillo
con articolazione a vite

MOD. WIEN

26-515-01 - 26-515-03 14,0 cm, 5 1/2 "



26-519-14



mit Schraubschluß
with screw joint
con articulación de tornillo
con articolazione a vite

BECKMANN

26-519-14 14,0 cm, 5 1/2 "

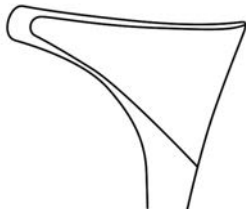

26-519-15



mit Schraubschluß
with screw joint
con articulación de tornillo
con articolazione a vite

BECKMANN

26-519-15 15,0 cm, 6 "

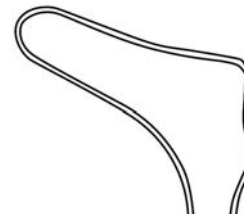

26-521-14



mit Schraubschluß
with screw joint
con articulación de tornillo
con articolazione a vite

HARTMANN

26-521-14 14,5 cm, 5 3/4 "



mit aseptischem Verschluss (zerlegbar)
with aseptic joint (dismantable)
con articulación aséptica (desmontable)
con articolazione asettica (smontabile)

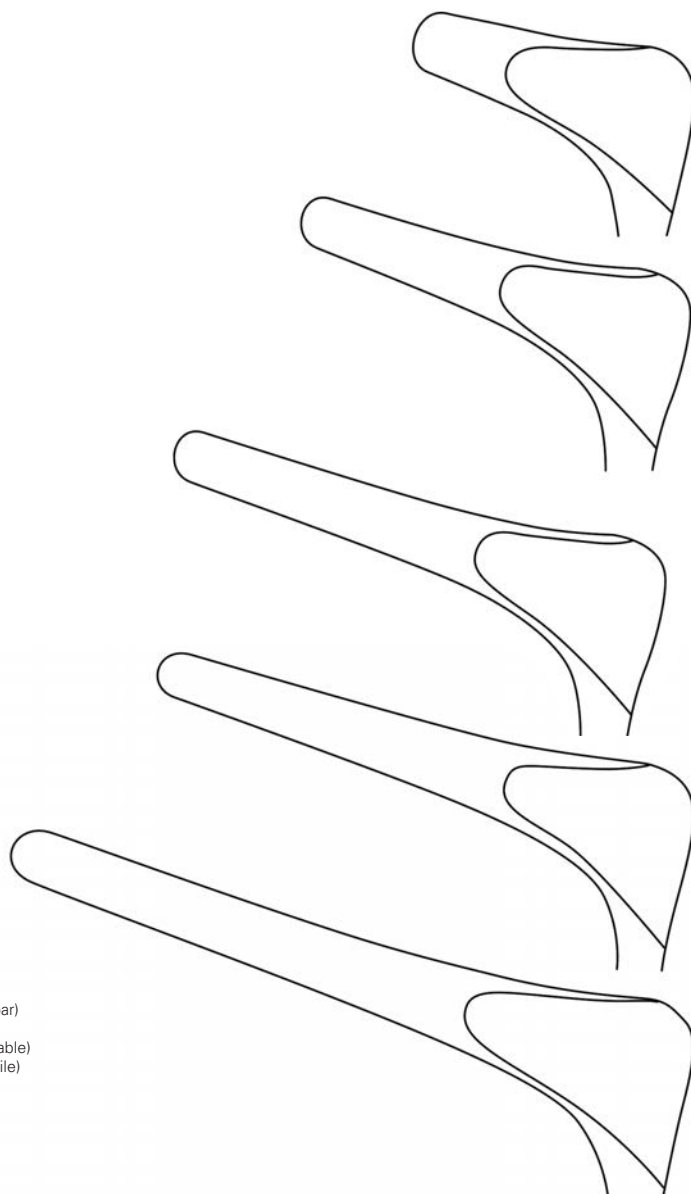

40 mm

26-524-01

55 mm

26-524-02

65 mm

26-524-03

75 mm

26-524-04

90 mm

26-524-05

KILLIAN

26-524-01 - 26-524-05 14,0 cm, 5 1/2"





AMNOTEC
KARL STORZ
OLYMPUS
ACMI
RICHARD WOLF

mit aseptischem Verschluss (zerlegbar) und Kaltlichtträger
with aseptic joint (dismantable) and fibre optic light carrier
con articulación aséptica (desmontable) y porta-luz fría
con articolazione asettica (smontabile) e supporto per luce fredda

KILLIAN

26-524-01 KL - 26-524-04 KL 14,0 cm, 5 1/2"

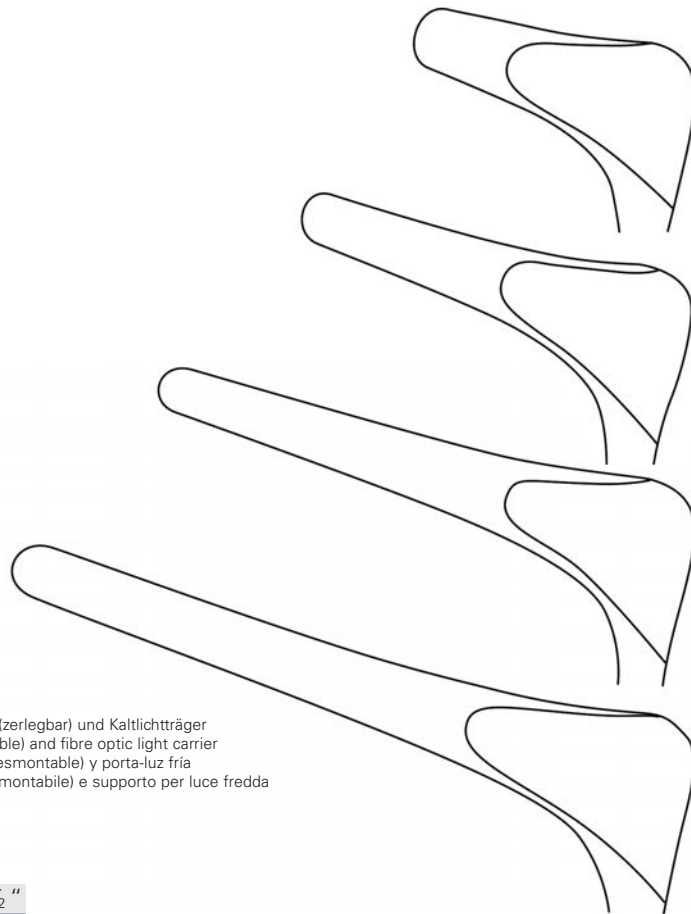

40 mm
26-524-01 KL

55 mm
26-524-02 KL

75 mm
26-524-03 KL

90 mm
26-524-04 KL



mit aseptischem Verschluss (zerlegbar)
with aseptic joint (dismantable)
con articulación aséptica (desmontable)
con articolazione asettica (smontabile)

KILLIAN

26-524-11 - 26-524-14 14,0 cm, 5 1/2"

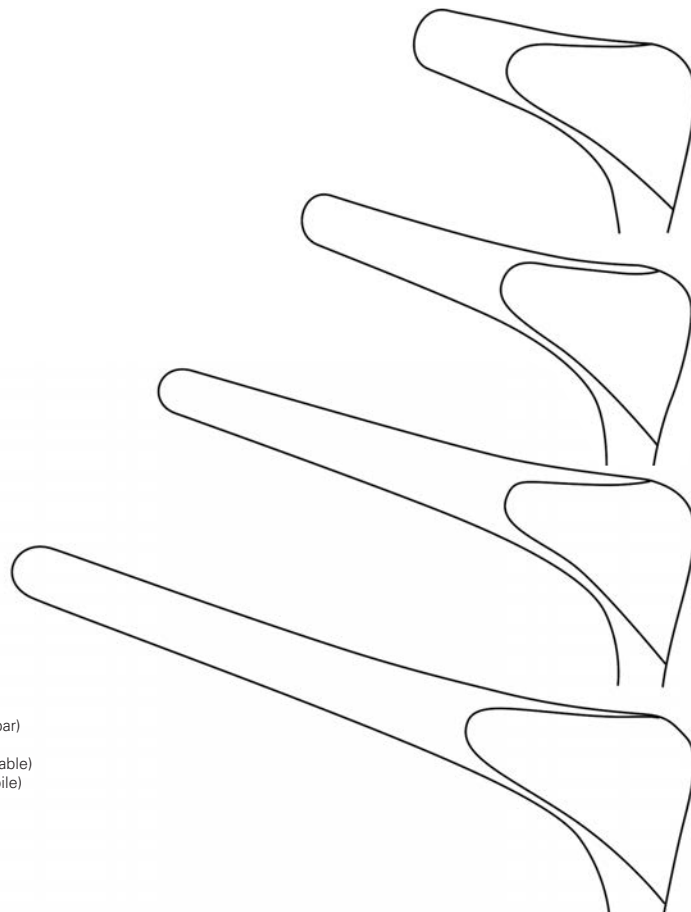

40 mm
26-524-11

55 mm
26-524-12

75 mm
26-524-13

90 mm
26-524-14



Aufnahme für flexiblen Spannarm
 Adaption for flexible arm
 Adaptación para brazo flexible
 Adattatore per braccio flessibile



mit aseptischem Verschluss (zerlegbar)
 with aseptic joint (dismantable)
 con articulación aséptica (desmontable)
 con articolazione aseptica (smontabile)

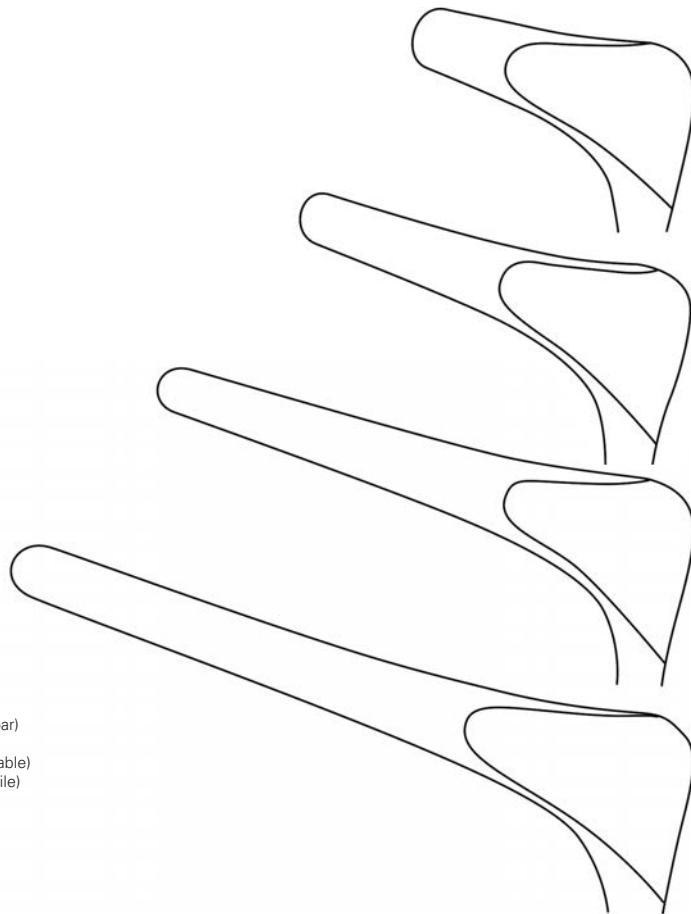

40 mm
26-524-21

55 mm
26-524-22

75 mm
26-524-23

90 mm
26-524-24

KILLIAN

26-524-21 - 26-524-24 14,0 cm, 5 1/2 "



Aufnahme für flexiblen Spannarm
 Adaption for flexible arm
 Adaptación para brazo flexible
 Adattatore per braccio flessibile



mit aseptischem Verschluss (zerlegbar)
 with aseptic joint (dismantable)
 con articulación aséptica (desmontable)
 con articolazione aseptica (smontabile)

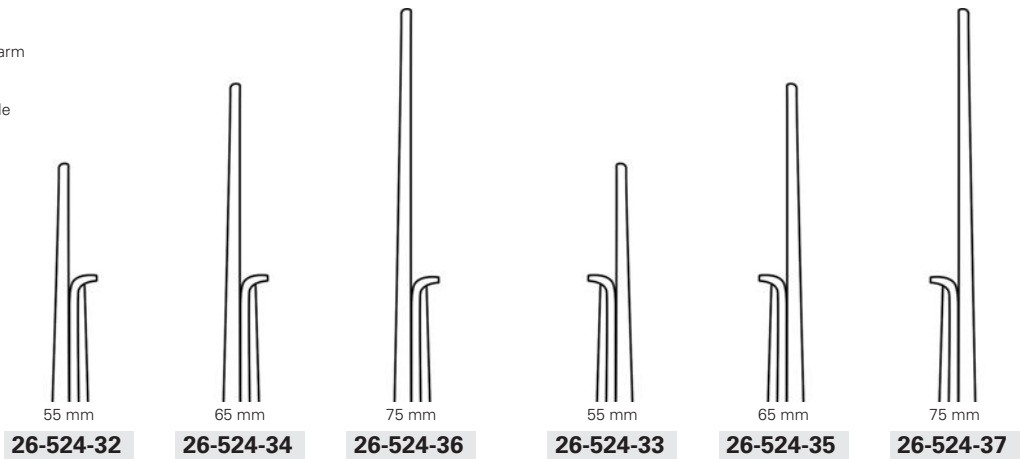

55 mm
26-524-32

65 mm
26-524-34

75 mm
26-524-36

55 mm
26-524-33

65 mm
26-524-35

75 mm
26-524-37

rechtes Blatt verkürzt mit Zähnen
 right blade shortened with teeth
 hoja derecha acortada con dientes
 lama destra ridotta con denti

linkes Blatt verkürzt mit Zähnen
 left blade shortened with teeth
 hoja izquierda acortada con dientes
 lama sinistra ridotta con denti

KILLIAN-RUDERT

26-524-32 - 26-524-37 14,0 cm, 5 1/2 "



mit Schraubschluß
with screw joint
con articulación de tornillo
con articolazione a vite

KILLIAN

26-525-01 - 26-525-04 14,0 cm, 5 1/2"

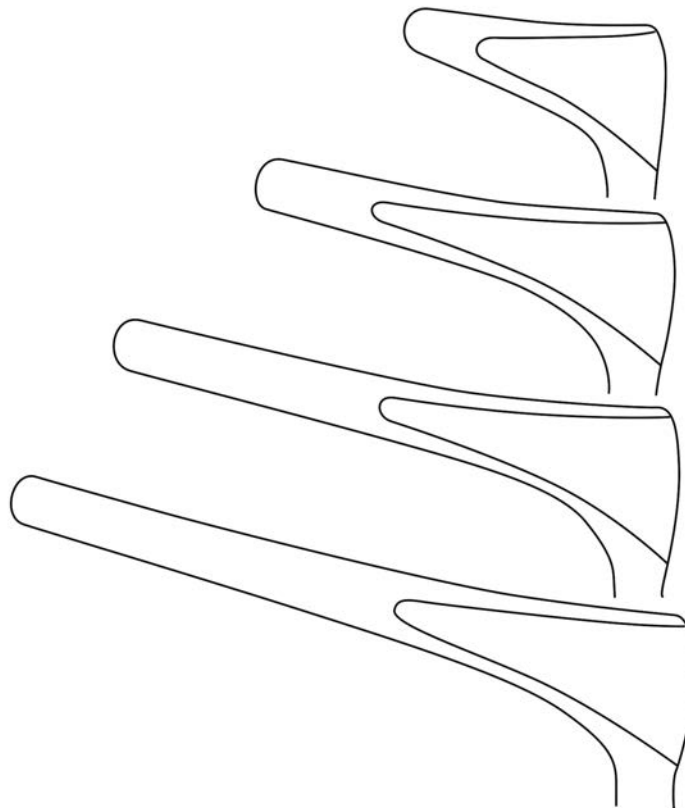

40 mm
26-525-01

55 mm
26-525-02

75 mm
26-525-03

90 mm
26-525-04



mit aseptischem Verschuß (zerlegbar)
with aseptic joint (dismantable)
con articulación aséptica (desmontable)
con articolazione aseptica (smontabile)

COTTLE

26-528-01 - 26-528-04 15,0 cm, 6"

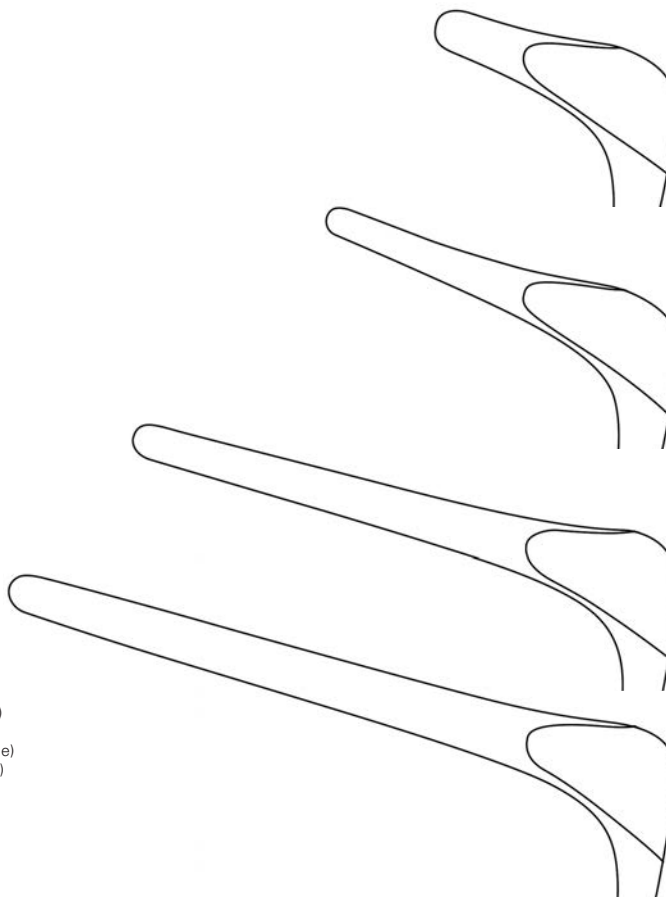

35 mm
26-528-01

55 mm
26-528-02

75 mm
26-528-03

90 mm
26-528-04



mit aseptischem Verschluss (zerlegbar)
 with aseptic joint (dismantable)
 con articulación aséptica (desmontable)
 con articolazione aseptica (smontabile)

COTTLE

26-529-01 - 26-529-04 15,0 cm, 6"

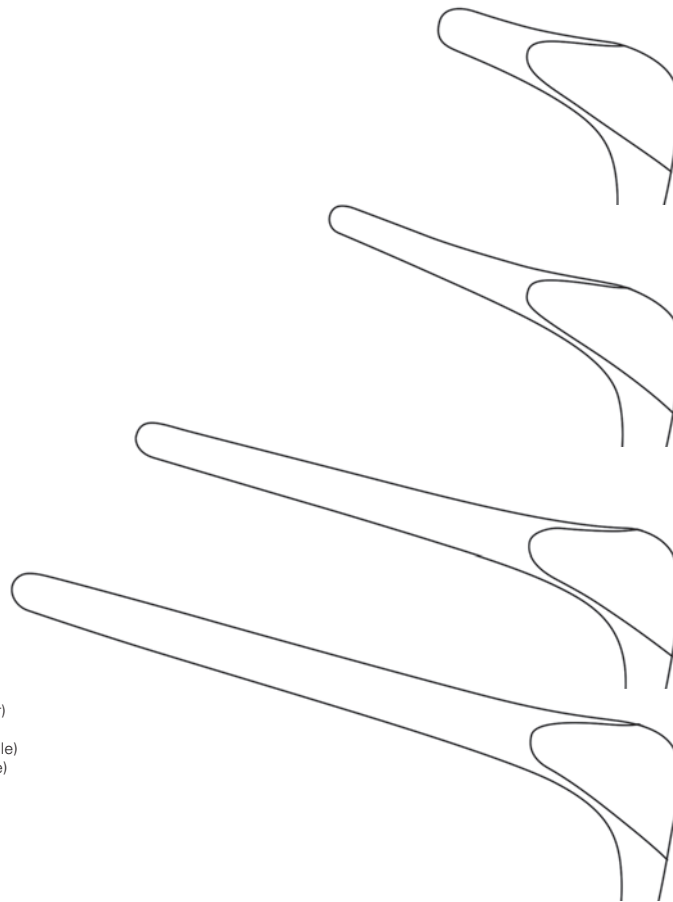

35 mm

26-529-01

55 mm

26-529-02

75 mm

26-529-03

90 mm

26-529-04



mit Schraubschluss
 with screw joint
 con articulación de tornillo
 con articolazione a vite

COTTLE

26-530-01 - 26-530-04 14,0 cm, 5 1/2"

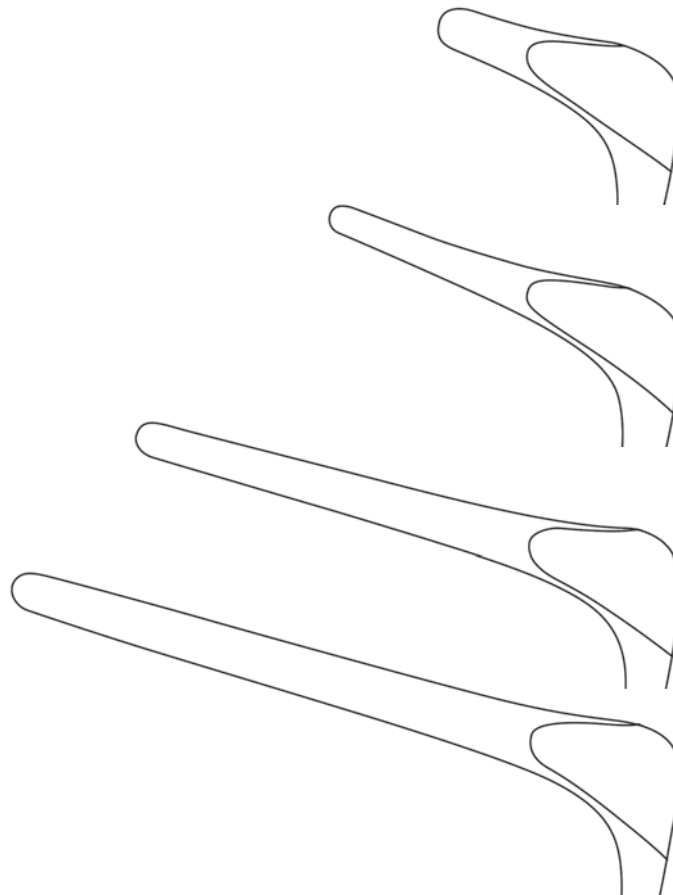

35 mm

26-530-01

50 mm

26-530-02

75 mm

26-530-03

90 mm

26-530-04



COTTLE

26-532-13 13,0 cm, 5 3/4"

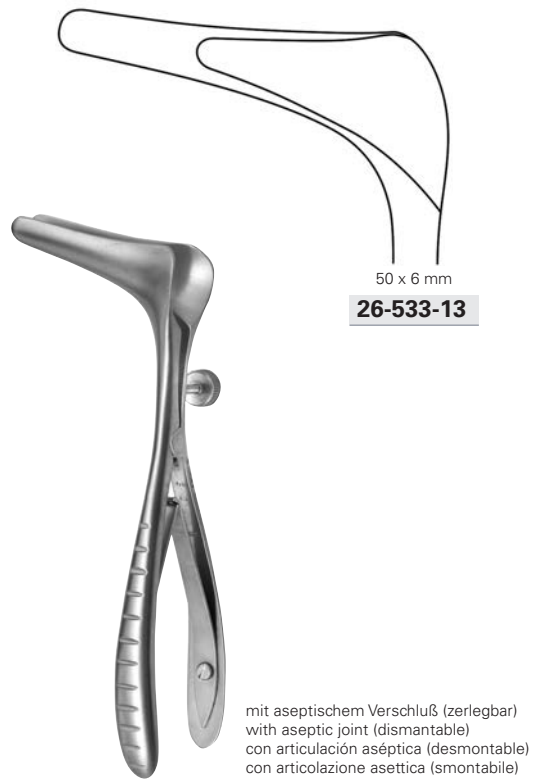

COTTLE

26-533-13 13,0 cm, 5 3/4"



COTTLE

26-535-01 15,0 cm, 6"



COTTLE

26-535-02 15,0 cm, 6"

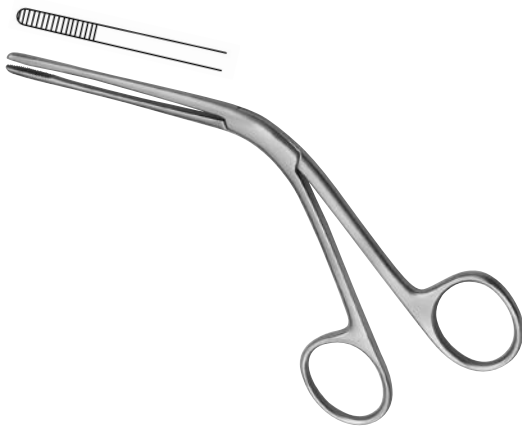

TILLEY

26-601-13 14,0 cm, 5 ½"

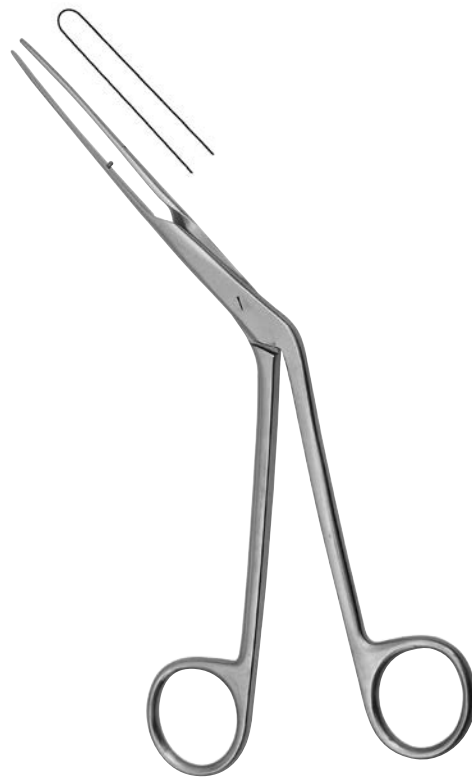

LUBET-BARBON

26-603-20 20,0 cm, 8"



WESTMACOTT

26-604-20 20,0 cm, 8"



HARTMANN

26-607-16 16,0 cm, 6 ¼"



HARTMANN

26-607-20 20,0 cm, 8"

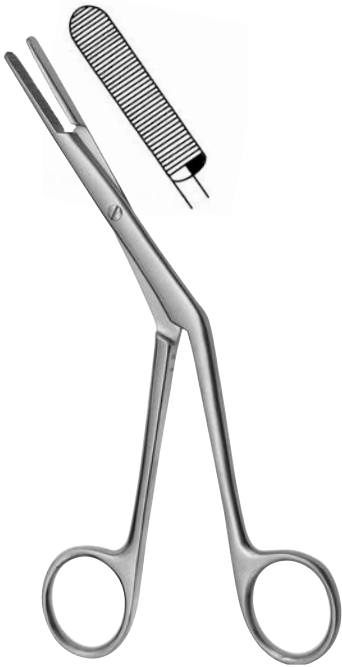

KILLIAN

26-609-17 17,0 cm, 6 ³/₄ "

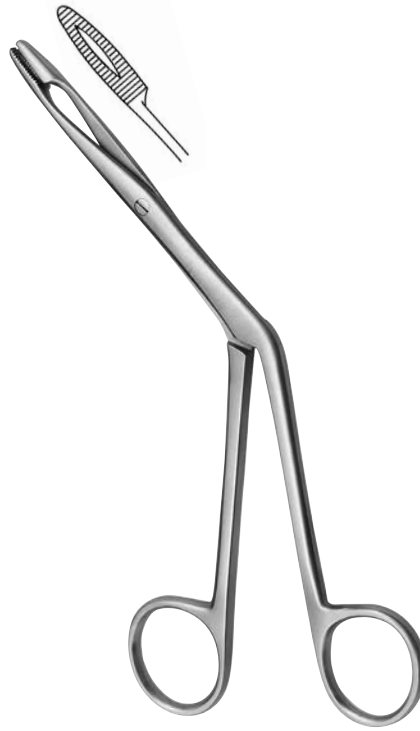

HEYMANN-KNIGHT

26-609-18 18,0 cm, 7 "



LITTAUER

26-611-18 18,0 cm, 7 "



HARTMANN

26-615-19 19,0 cm, 7 ¹/₂ "



KRAUSE

26-621-26 26,0 cm, 10 ¼"



KRAUSE-VOSS

26-623-26 26,0 cm, 10 ¼"

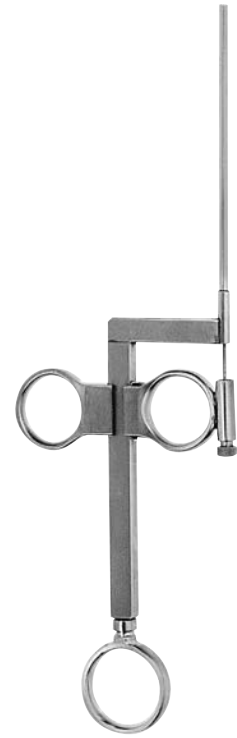

LANGE-WILDE

26-624-24 24,0 cm, 9 ½"



Verpackungseinheit: 12 St.
 Packing unit: 12 pieces
 Unidad: 12 piezas
 Confezione: 12 pezzi

Schnürdrähte
 Snare wires
 Alambre para amigdalótomo
 Filo per serranodi



Verpackungseinheit: 100 St.
 Packing unit: 100 pieces
 Unidad: 100 piezas
 Confezione: 100 pezzi

Schnürdrähte
 Snare wires
 Alambre para amigdalótomo
 Filo per serranodi

Schnürdrähte, Rolle mit 10 m
 Snare wires, coil of 10 m
 Alambre para amigdalótomo, rollo de 10 m
 Filo per serranodi, rotolo da 10 m



26-627-30 Ø 0,3 mm

26-627-40 Ø 0,4 mm



26-627-93 Ø 0,3 mm

26-627-94 Ø 0,4 mm



26-158-02 Ø 0,2 mm

26-158-03 Ø 0,3 mm

26-158-04 Ø 0,4 mm

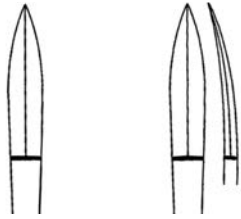

26-640-14

gerade
straight
recta
retto



Nasenplastikmesser
Rhinoplastic knives
Cuchillos para rinoplástica
Coltelli per plastica nasale

26-641-14

gebogen
curved
curva
curvo



26-642-99

Ersatzklinge
Spare blade
Hoja de repuesto
Lama di ricambio

Septummesser
Septum knife
Cuchillos para el tabique nasal
Coltelli per setto nasale

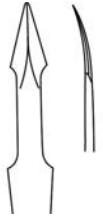

26-645-14

gebogen
curved
curva
curvo



Knorpelritzmesser
Cartilage slitting knife
Cuchillos para rajar cartilagos
Coltelli per scalfire la cartilagine

JOSEPH

26-640-14 - 26-641-14 14,5 cm, 5 3/4"

BRUENINGS

26-642-16 16,0 cm, 6 1/4"

MASING

26-645-14 14,0 cm, 5 1/2"



26-644-13

gebogen
curved
curva
curvo



Knorpelritzmesser
Cartilage slitting knife
Cuchillos para rajar cartilagos
Coltelli per scalfire la cartilagine



26-644-14

gerade
straight
recta
retto



Knorpelritzmesser
Cartilage slitting knife
Cuchillos para rajar cartilagos
Coltelli per scalfire la cartilagine



26-645-16



Nasenplastikmesser
Rhinoplastic knife
Cuchillos para rinoplástica
Coltelli per plastica nasale

MASING

26-644-13 13,5 cm, 5 1/4"

MASING

26-644-14 13,5 cm, 5 1/4"

FOMON

26-645-16 16,0 cm, 6 1/4"



FREER

26-646-15 15,5 cm, 6 1/8"



JOSEPH

26-647-17 17,5 cm, 7"



CONVERSE

26-649-16 16,0 cm, 6 1/4"



JOSEPH

26-650-15 15,0 cm, 6"



COTTLE

26-652-15 15,0 cm, 6"

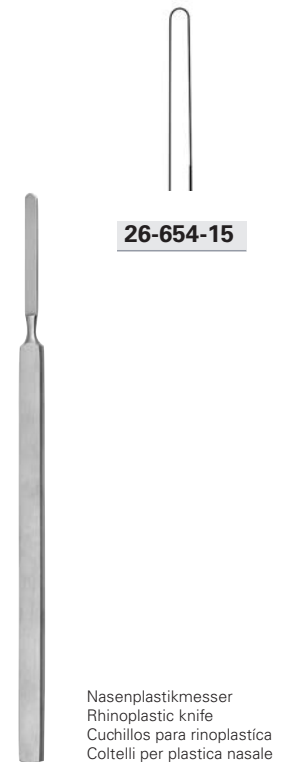

COTTLE

26-654-15 15,0 cm, 6"



3,3 mm
26-655-18

HALLE

26-655-18 18,0 cm, 7 "



Ø 4,0 mm
26-660-21

Saugelevator
Suction elevator
Elevador de succión
Elevatori d'aspirazione

FREER-GORNEY

26-660-21 21,0 cm, 8 ¼ "

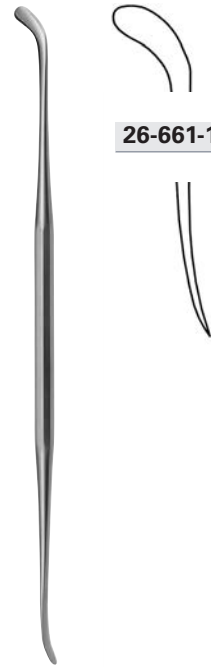

26-661-18

FREER

26-661-18 17,5 cm, 7 "

scharf
sharp
agudo
acuto

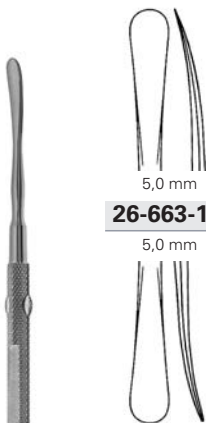

5,0 mm
26-663-18
5,0 mm

stumpf
blunt
romo
smusso

FREER

26-663-18 18,0 cm, 7 "

scharf
sharp
agudo
acuto

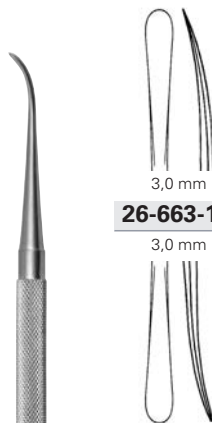

3,0 mm
26-663-19
3,0 mm

scharf
sharp
agudo
acuto

FREER-YASARGIL

26-663-19 18,5 cm, 7 ¼ "

scharf
sharp
agudo
acuto

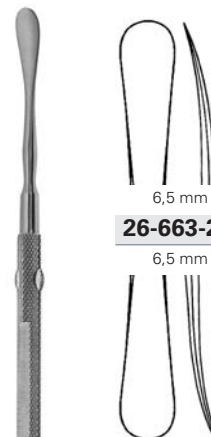

6,5 mm
26-663-20
6,5 mm

stumpf
blunt
romo
smusso

FREER

26-663-20 20,0 cm, 8 "



FREER-JOSEPH

26-663-21 20,0 cm, 8 "



26-665-20

5,0 mm



FREER

26-665-20 20,0 cm, 8 "



26-668-19

FREER

26-668-19 19,0 cm, 7 ½ "



26-669-01

FREER

26-669-01 19,0 cm, 7 ½ "



26-669-02

FREER

26-669-02 19,0 cm, 7 ½ "



26-669-03

FREER

26-669-03 19,0 cm, 7 ½ "



26-670-17 17,0 cm, 6 3/4"



26-672-21



PIERCE

26-672-21 21,0 cm, 8 1/4"



26-673-21

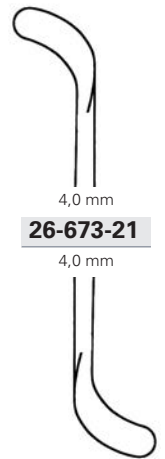

PENNINGTON

26-673-21 21,0 cm, 8 1/4"

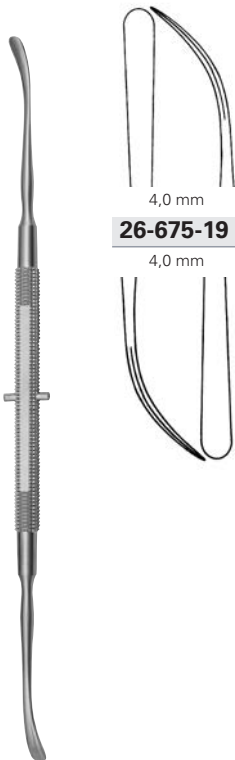

26-675-19

4,0 mm

4,0 mm

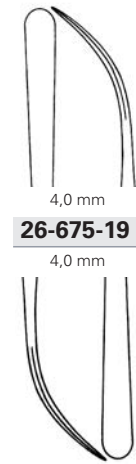

ROGER

26-675-19 19,0 cm, 7 1/2"



26-678-19

5,0 mm

4,5 mm

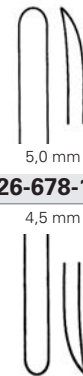

MC KENTY

26-678-19 19,0 cm, 7 1/2"



26-679-20

6,0 mm

6,0 mm

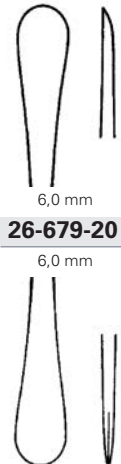

BALLENGER-HAJEK

26-679-20 19,0 cm, 7 1/2"

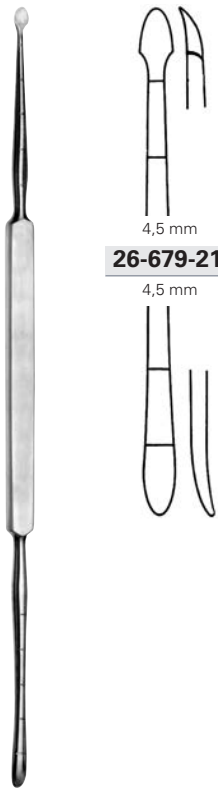

4,5 mm
26-679-21
 4,5 mm

COTTLE

26-679-21 21,0 cm, 8 ¼"

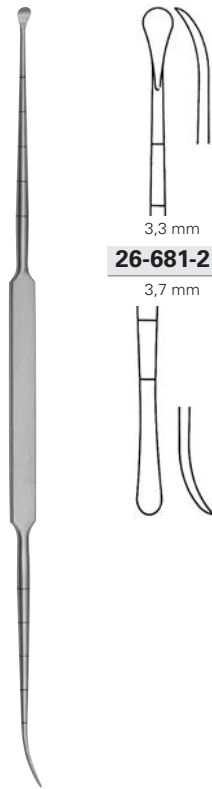

3,3 mm
26-681-21
 3,7 mm

COTTLE

26-681-21 21,0 cm, 8 ¼"

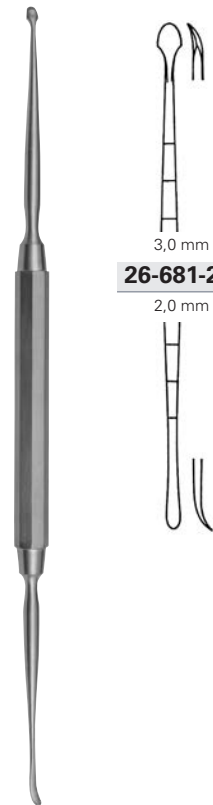

3,0 mm
26-681-22
 2,0 mm

MASING

26-681-22 22,0 cm, 8 ¾"



3,0 mm
26-683-03

4,0 mm
26-683-04

5,0 mm
26-683-05

MC KENTY

26-683-03 - 26-683-05 15,0 cm, 6"



6,5 mm
26-687-16

JOSEPH

26-687-16 16,0 cm, 6 ¼"



4,0 mm
26-688-22

JOSEPH-MASING

26-688-22 22,0 cm, 8 ¾"



3,5 mm
26-689-18
3,5 mm

KILLIAN

26-689-18 18,0 cm, 7 "

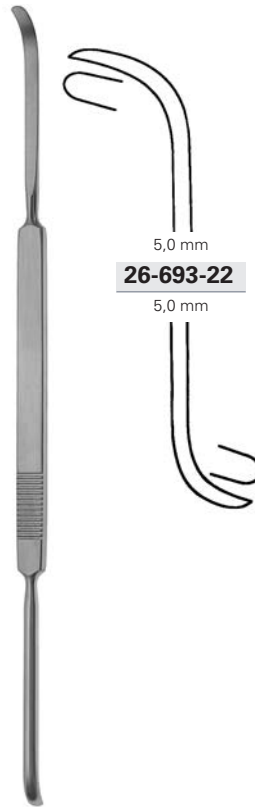

5,0 mm
26-693-22
5,0 mm

COTTLE

26-693-22 23,0 cm, 9 "



26-695-22

HOWARTH

26-695-22 21,5 cm, 8 1/2 "



Ø 3,5 mm

Saugraspatorium
Suction raspatory
Legra de succión
Periostotomi d'aspirazione

GUILEN

26-697-14 14,5 cm, 5 3/4 "



Ø 3,5 mm

Saugraspatorium
Suction raspatory
Legra de succión
Periostotomi d'aspirazione

GUILEN

26-698-14 14,5 cm, 5 3/4 "



Ø 4,0 mm

Saugraspatorium
Suction raspatory
Legra de succión
Periostotomi d'aspirazione

26-699-20 20,0 cm, 8 "

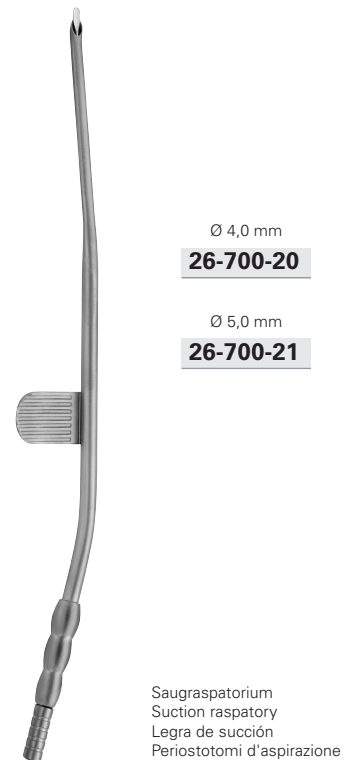

Ø 4,0 mm
26-700-20

Ø 5,0 mm
26-700-21

Saugraspatorium
Suction raspatory
Legra de succión
Periostotomi d'aspirazione

26-700-20 20,0 cm, 8 "
26-700-21 20,0 cm, 8 "

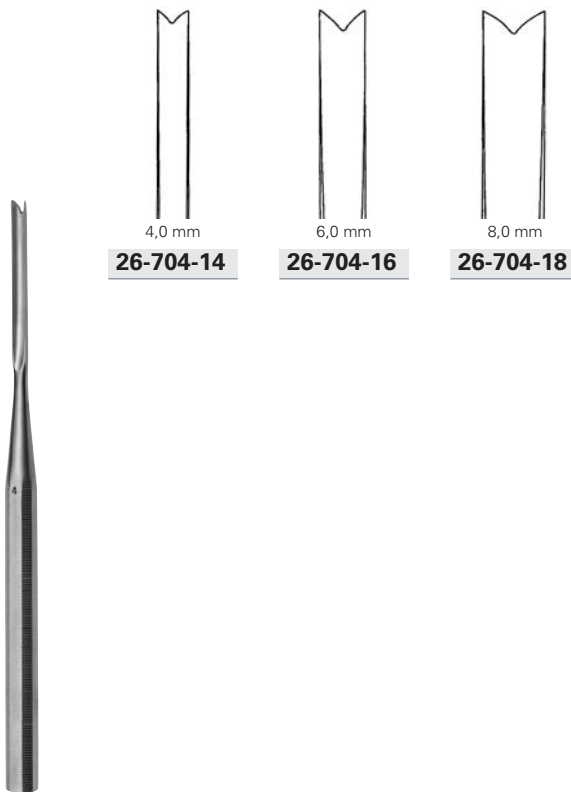

4,0 mm
26-704-14

6,0 mm
26-704-16

8,0 mm
26-704-18

BALLENGER

26-704-14 - 26-704-18 15,5 cm, 6"



6,0 mm
26-705-17

KILLIAN

26-705-17 17,0 cm, 6 3/4"



5,0 mm
26-707-17

KILLIAN-CLAUS

26-707-17 17,0 cm, 6 3/4"

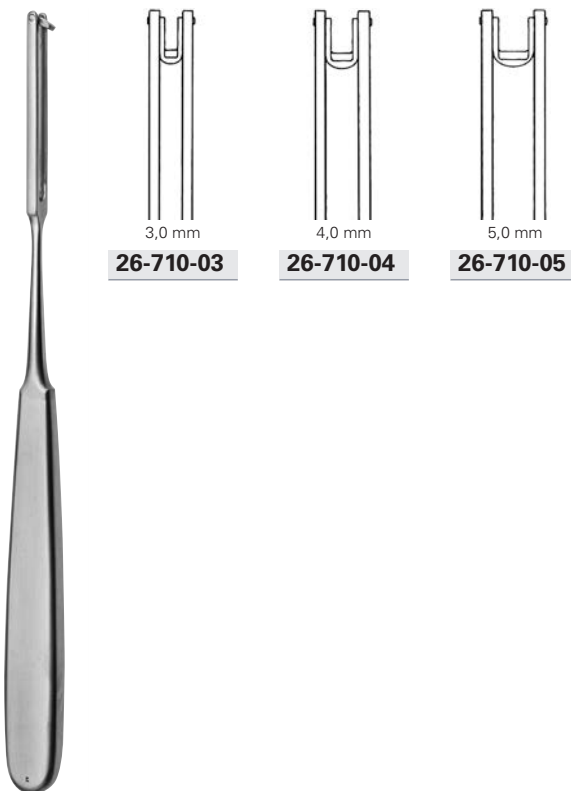

3,0 mm
26-710-03

4,0 mm
26-710-04

5,0 mm
26-710-05

BALLENGER

26-710-03 - 26-710-05 21,0 cm, 8 1/4"

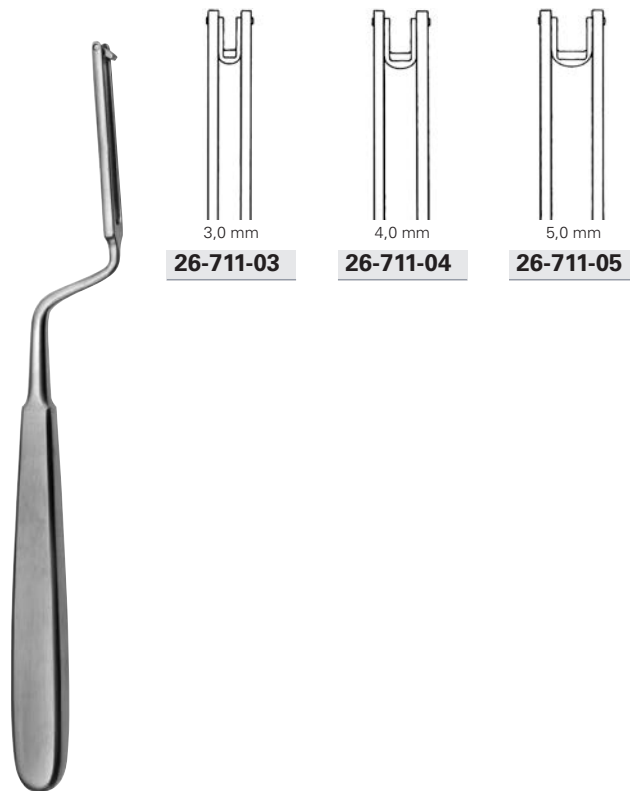

3,0 mm
26-711-03

4,0 mm
26-711-04

5,0 mm
26-711-05

BALLENGER

26-711-03 - 26-711-05 20,0 cm, 8"

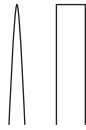

40-278-04	4,0 mm
40-278-06	6,0 mm
40-278-08	8,0 mm
40-278-10	10,0 mm
40-278-12	12,0 mm

Osteotome, graduiert
Osteotomes, graduated
Osteótomos, graduado
Osteotomi, graduato

COTTLE

40-278-04 - 40-278-12 18,0 cm, 7 "

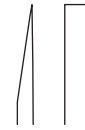

40-279-04	4,0 mm
40-279-05	5,0 mm
40-279-06	6,0 mm
40-279-07	7,0 mm
40-279-09	9,0 mm
40-279-12	12,0 mm

Flachmeißel, graduiert
Chisels, graduated
Cinceles, graduado
Scalpelli, graduato

COTTLE

40-279-04 - 40-279-12 18,0 cm, 7 "

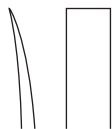

26-721-06

Osteotom, graduiert
Osteotome, graduated
Osteótomo, graduado
Osteotomo, graduato

COTTLE

26-721-06 18,0 cm, 7 "

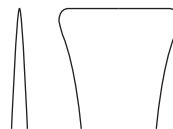

26-724-16

Osteotom, graduiert
Osteotome, graduated
Osteótomo, graduado
Osteotomo, graduato

COTTLE

26-724-16 18,0 cm, 7 "

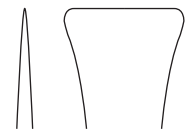

26-726-16

Osteotom, graduiert
Osteotome, graduated
Osteótomo, graduado
Osteotomo, graduato

COTTLE

26-726-16 18,0 cm, 7 "

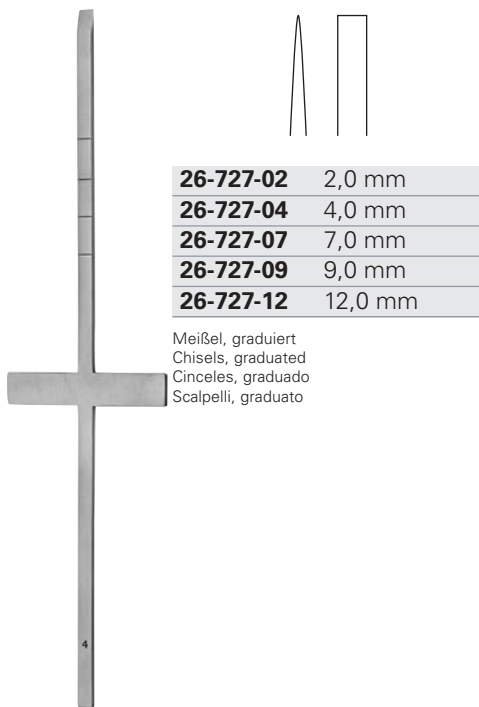

26-727-02	2,0 mm
26-727-04	4,0 mm
26-727-07	7,0 mm
26-727-09	9,0 mm
26-727-12	12,0 mm

Meißel, graduiert
 Chisels, graduated
 Cinceles, graduado
 Scalpelli, graduato

COTTLE

26-727-02 - 26-727-12 18,5 cm, 7 ¼"

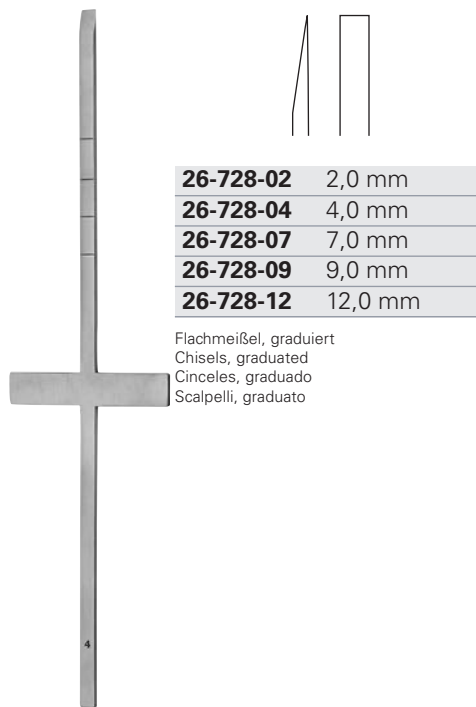

26-728-02	2,0 mm
26-728-04	4,0 mm
26-728-07	7,0 mm
26-728-09	9,0 mm
26-728-12	12,0 mm

Flachmeißel, graduiert
 Chisels, graduated
 Cinceles, graduado
 Scalpelli, graduato

COTTLE

26-728-02 - 26-728-12 18,5 cm, 7 ¼"

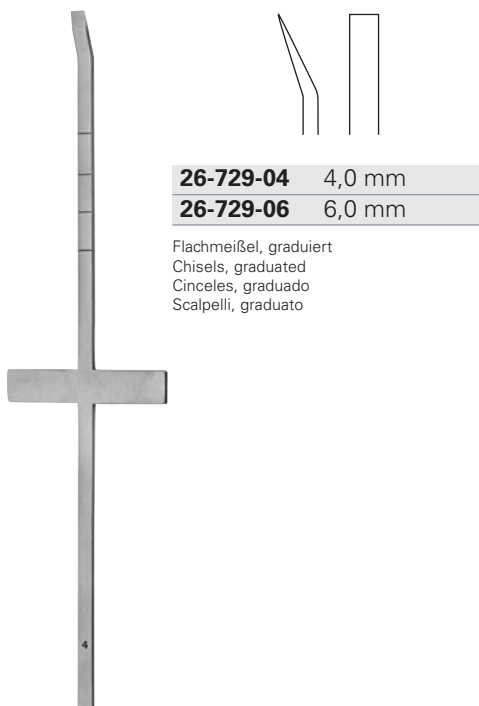

26-729-04	4,0 mm
26-729-06	6,0 mm

Flachmeißel, graduiert
 Chisels, graduated
 Cinceles, graduado
 Scalpelli, graduato

COTTLE

26-729-04 - 26-729-06 18,5 cm, 7 ¼"

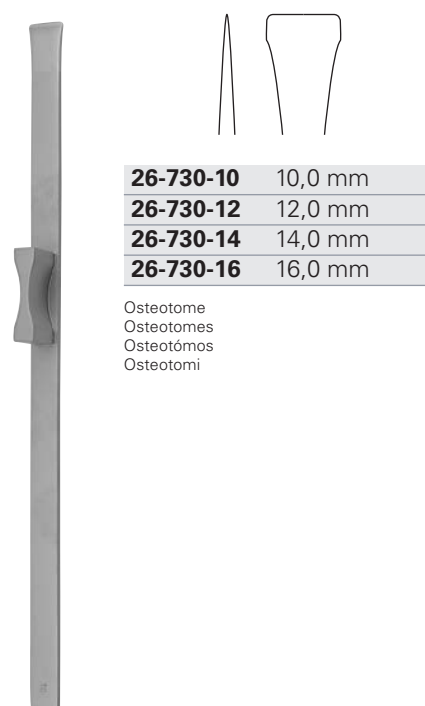

26-730-10	10,0 mm
26-730-12	12,0 mm
26-730-14	14,0 mm
26-730-16	16,0 mm

Osteotome
 Osteotomes
 Osteótomos
 Osteotomi

RUBIN

26-730-10 - 26-730-16 18,0 cm, 7"



26-732-03	3,0 mm
26-732-04	4,5 mm

Flachmeißel
Chisels
Cinceles
Scalpelli

WALTER

26-732-03 - 26-732-04 18,0 cm, 7 "



26-733-02	2,0 mm
26-733-03	3,0 mm
26-733-04	4,0 mm
26-733-07	7,0 mm
26-733-09	9,0 mm
26-733-12	12,0 mm

Osteotome
Osteotomes
Osteótomos
Osteotomi

WALTER

26-733-03 - 26-733-12 18,0 cm, 7 "

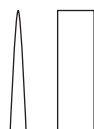

26-734-01	1,0 mm
26-734-02	2,0 mm
26-734-03	3,0 mm
26-734-04	4,0 mm
26-734-05	5,0 mm
26-734-06	6,0 mm
26-734-07	7,0 mm
26-734-08	8,0 mm
26-734-10	10,0 mm
26-734-12	12,0 mm

Osteotome
Osteotomes
Osteótomos
Osteotomi

SHEEHAN

26-734-01 - 26-734-12 15,5 cm, 6 1/8 "

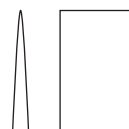

26-735-02	2,0 mm
26-735-03	3,0 mm
26-735-04	4,0 mm
26-735-05	5,0 mm
26-735-06	6,0 mm
26-735-07	7,0 mm
26-735-08	9,0 mm
26-735-09	9,0 mm
26-735-10	10,0 mm
26-735-11	11,0 mm
26-735-12	12,0 mm
26-735-14	14,0 mm

Osteotome
Osteotomes
Osteótomos
Osteotomi



CONVERSE

26-735-02 - 26-735-14 18,0 cm, 7 "

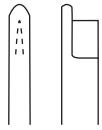

26-736-04	4,0 mm
26-736-05	5,0 mm
26-736-06	6,0 mm
26-736-07	7,0 mm

Osteotome
Osteotomes
Osteótomos
Osteotomi

FOMON

26-736-04 - 26-736-07 17,0 cm, 6 ¾ "

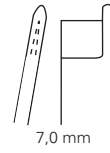

26-737-01

rechts gebogen
curved to right
curva a la derecha
curvo verso destra

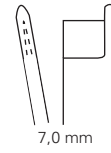

26-737-02

links gebogen
curved to left
curva a la izquierda
curvo verso sinistra



26-737-03

gerade
straight
recta
retto

Osteotome
Osteotomes
Osteótomos
Osteotomi

NEIVERT-ANDERSON

26-737-01 - 26-737-03 20,5 cm, 8 "

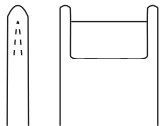

26-740-10	10,0 mm
26-740-12	12,0 mm
26-740-14	14,0 mm
26-740-16	16,0 mm

Osteotome
Osteotomes
Osteótomos
Osteotomi

CINELLI

26-740-10 - 26-740-16 16,0 cm, 6 ¼ "



26-741-01

gerade
straight
recta
retto



26-741-02

links gebogen
curved to left
curva a la izquierda
curvo verso sinistra



26-741-03

rechts gebogen
curved to right
curva a la derecha
curvo verso destra

Osteotome
Osteotomes
Osteótomos
Osteotomi

SILVER

26-741-01 - 26-741-03 17,5 cm, 7 "



26-743-01

links
left
izquierda
sinistra

26-743-02

rechts
right
derecha
destra

Osteotome
Osteotomes
Osteótomos
Osteotomi

GUSTELLA

26-743-01 - 26-743-02 17,5 cm, 7 "

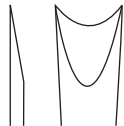

26-744-09 9,0 mm

26-744-11 11,0 mm

26-744-13 13,0 mm

26-744-15 15,0 mm

Osteotome
Osteotomes
Osteótomos
Osteotomi

MC INDOE

26-744-09 - 26-744-15 14,5 cm, 5 ¾ "



links abgewinkelt
 angled to left
 angulado por izquierdo
 angolato a sinistra

JOSEPH

26-751-01 17,0 cm, 6 3/4 "



rechts abgewinkelt
 angled to right
 angulado por derecho
 angolato a destra

JOSEPH

26-751-02 17,0 cm, 6 3/4 "

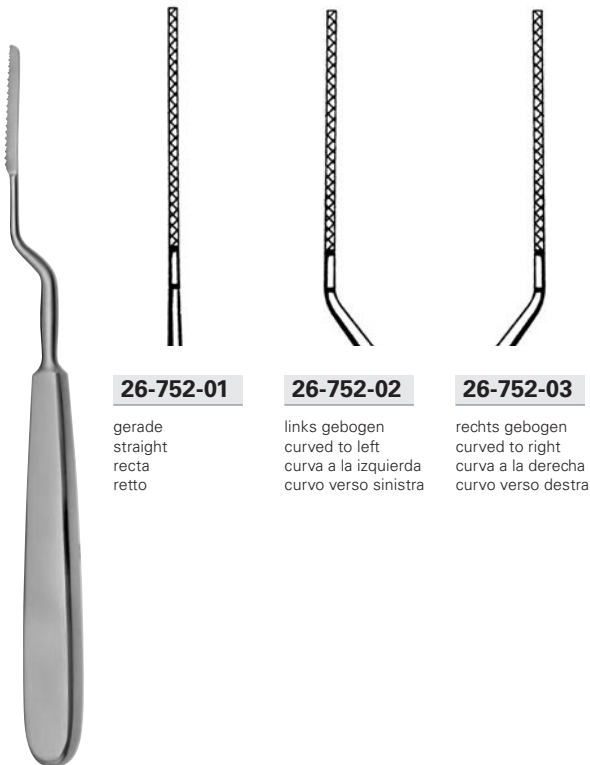

26-752-01

gerade
 straight
 recta
 retto

26-752-02

links gebogen
 curved to left
 curva a la izquierda
 curvo verso sinistra

26-752-03

rechts gebogen
 curved to right
 curva a la derecha
 curvo verso destra

JOSEPH

26-752-01 - 26-752-03 19,0 cm, 7 1/2 "

Biegegerät zum Formen von Drahtprothesen
Die to pre-form wire prothesis
Aparato de doblar para moldear prótesis metálicas
Strumento curvo per modellare fili guida



SCHUHKNECHT

26-754-00

Knorpelquetsche
Cartilage Crusher
Machacadora
Torchio per cartilagine

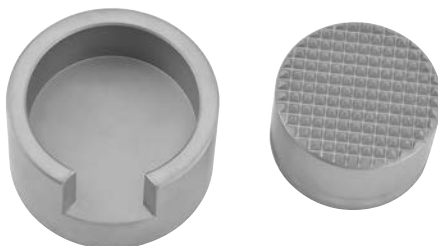

26-755-00

Knorpelquetsche
Cartilage Crusher
Machacadora
Torchio per cartilagine



COTTLE

26-756-00

Columellapinzette
Columella forceps
Pinza para columela
Pinza per columella



26-760-10

COTTLE

26-760-10 10,0 cm, 4"

Fixierpinzette
Fixation forceps
Pinza de fijacion
Pinza di fissaggio



26-761-14

COTTLE

26-761-14 14,0 cm, 5 1/2"

Hautfasspinzette
Skin grasping forceps
Pinza para coger la piel
Pinza per afferrare la pelle



26-762-11

5 x 6 Zähne
5 x 6 teeth
5 x 6 dientes
5 x 6 denti

GRAEFE

26-762-11 11,0 cm, 4 1/4"

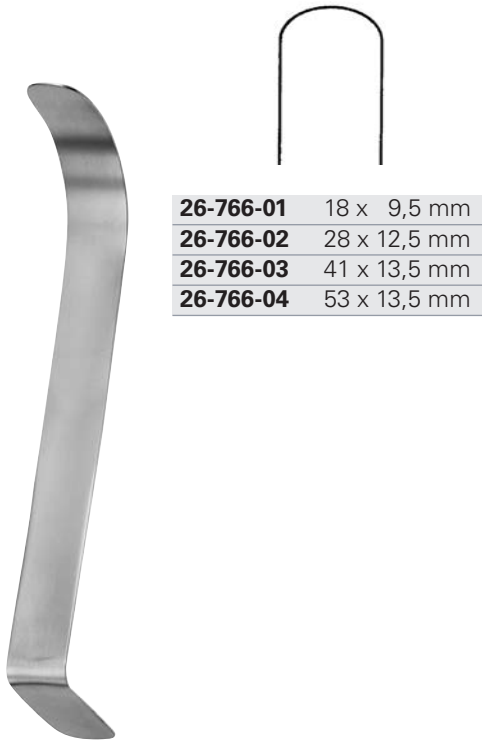

26-766-01	18 x 9,5 mm
26-766-02	28 x 12,5 mm
26-766-03	41 x 13,5 mm
26-766-04	53 x 13,5 mm



55 x 10 mm
26-767-00

mit Fiberglas-Lichtträger und Lichtquelle
 with fiberoptic light carrier and light source
 con portador de luz de fibra de vidrio y fuente de luz
 con supporto in vetroresina e fonte luminosa

CONVERSE

26-766-01 - 26-766-04 9,0 cm, 3 1/2"

26-767-00 21,5 cm, 8 1/2"

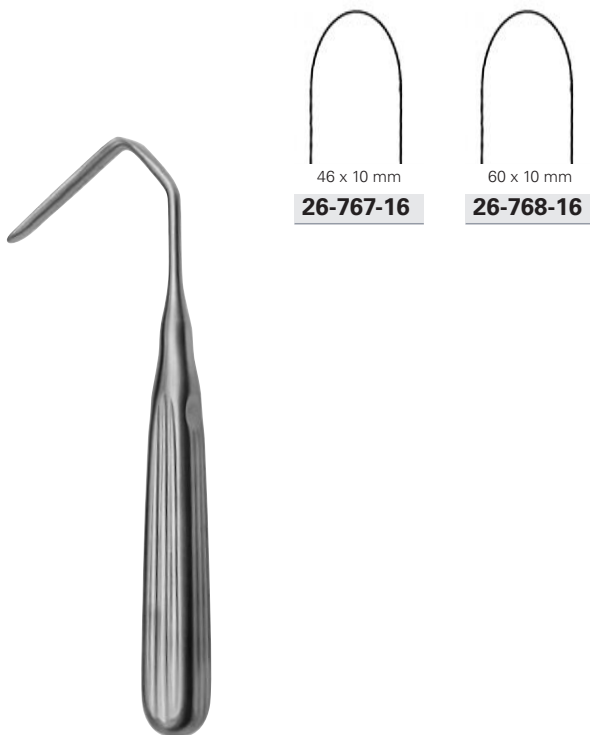

46 x 10 mm
26-767-16

60 x 10 mm
26-768-16

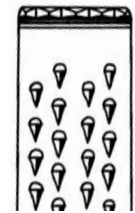

26-768-19

AUFRICHT

26-767-16 - 26-768-16 16,0 cm, 6 1/4"

BRUENINGS-BRUNK

26-768-19 19,0 cm, 7 1/2"



WALTER

26-769-13 13,5 cm, 5 ¼"



KILNER

26-770-10 8,0 cm, 3 ¼"



10,0 mm

26-770-10

scharf
sharp
agudo
acuto



COTTLE

26-770-15 15,0 cm, 6"



4,0 mm

26-770-15

scharf
sharp
agudo
acuto



CONVERSE

26-771-12 12,0 cm, 4 ¾"



26-771-12

scharf
sharp
agudo
acuto



COTTLE

26-772-01 - 26-772-03 15,0 cm, 6"



26-772-01

scharf
sharp
agudo
acuto



26-772-02

scharf
sharp
agudo
acuto



26-772-03

scharf
sharp
agudo
acuto



COTTLE

26-774-16 16,0 cm, 6 ¼"



26-774-16

scharf
sharp
agudo
acuto



FOMON

26-776-17 17,0 cm, 6 ¾"



26-776-17



FOMON

26-777-00 5,5 cm, 2 1/8"



COTTLE

26-778-01 - 26-778-03 14,5 cm, 5 3/4"



26-778-01

spitz | spitz
 sharp | sharp
 agudo | agudo
 acuto | acuto



26-778-02

stumpf | spitz
 blunt | sharp
 romo | agudo
 smusso | acuto



26-778-03

spitz | stumpf
 sharp | blunt
 agudo | romo
 acuto | smusso



26-778-04

stumpf
 blunt
 romo
 smusso



COTTLE

26-778-04 14,0 cm, 5 1/2"



10,0 mm

26-779-05

scharf
 sharp
 agudo
 acuto



MILLARD (COTTLE)

26-779-05 5,5 cm, 2 1/8"



FOMON

26-779-16 16,0 cm, 6 1/4"



26-779-16

stumpf | stumpf
 blunt | blunt
 romo | romo
 smusso | smusso



COTTLE-NEIVERT

26-780-20 20,0 cm, 8"



26-780-20





NEIVERT

26-782-16 16,0 cm, 6 1/4"



MASING

26-783-01 - 26-783-02 14,0 cm, 5 1/2"



COTTLE

26-785-15 15,0 cm, 6"

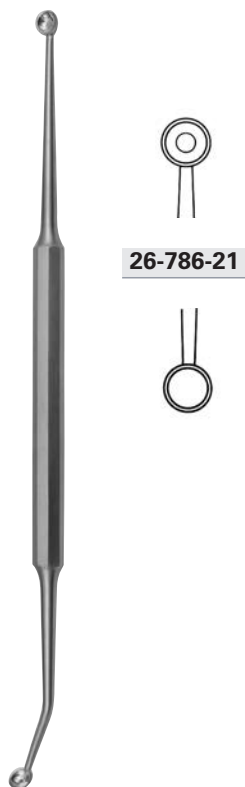

PRATT

26-786-21 21,0 cm, 8 1/4"

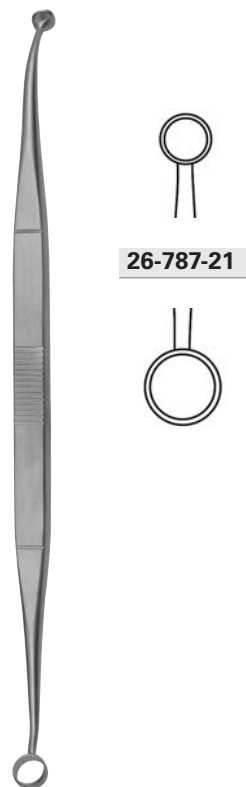

FAULKNER

26-787-21 21,0 cm, 8 1/4"

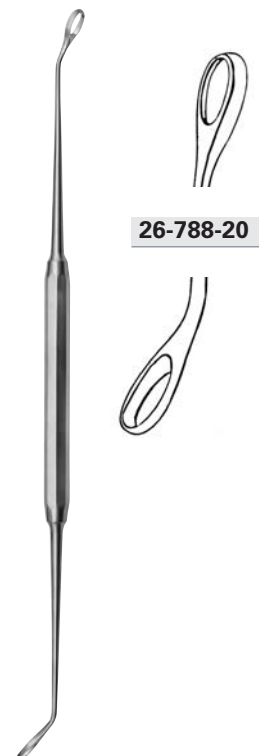

COAKLEY

26-788-20 20,0 cm, 8"



Fig. 1

26-790-01



Fig. 2

26-790-02



Fig. 3

26-790-03



Fig. 4

26-790-04



Fig. 5

26-790-05



Fig. 6

26-790-06



26-791-01

spitz
sharp
agudo
acuto



26-791-02

stumpf
blunt
roma
smusso

COAKLEY

26-790-01 - 26-790-06 17,0 cm, 6 3/4 "

26-791-01 - 26-791-02 19,0 cm, 7 1/2 "



Fig. 1

26-791-03



Fig. 2

26-791-04



Fig. 3

26-791-05



26-791-06



26-791-07

26-791-03 - 26-791-05 19,0 cm, 7 1/2 "

26-791-06 - 26-791-07 19,0 cm, 7 1/2 "

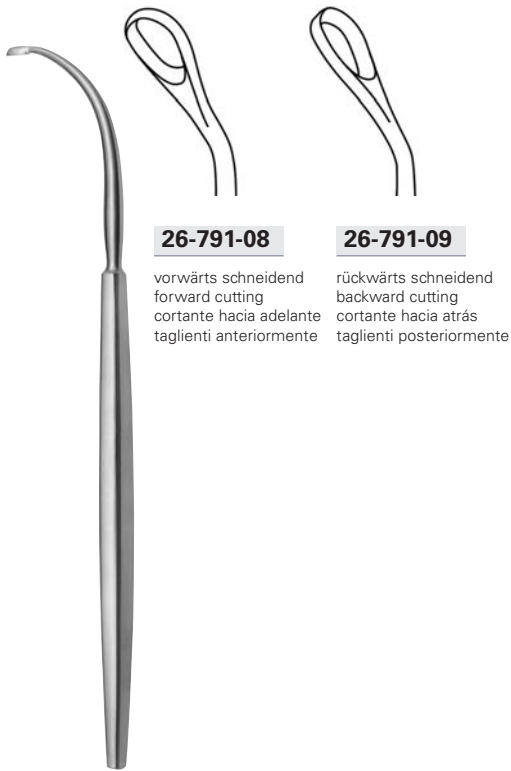

26-791-08

vorwärts schneidend
forward cutting
cortante hacia adelante
taglianti anteriormente

26-791-09

rückwärts schneidend
backward cutting
cortante hacia atrás
taglianti posteriormente

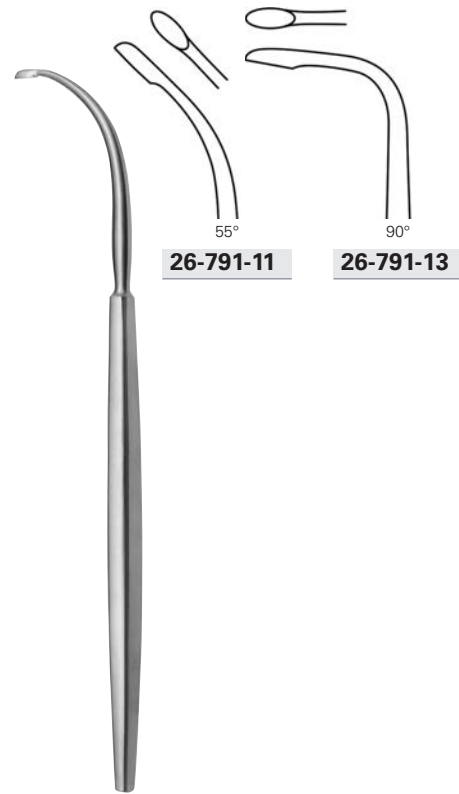

26-791-11

26-791-13

COAKLEY

26-791-08 - 26-791-09 19,0 cm, 7 1/2"

26-791-11 - 26-791-13 19,0 cm, 7 1/2"

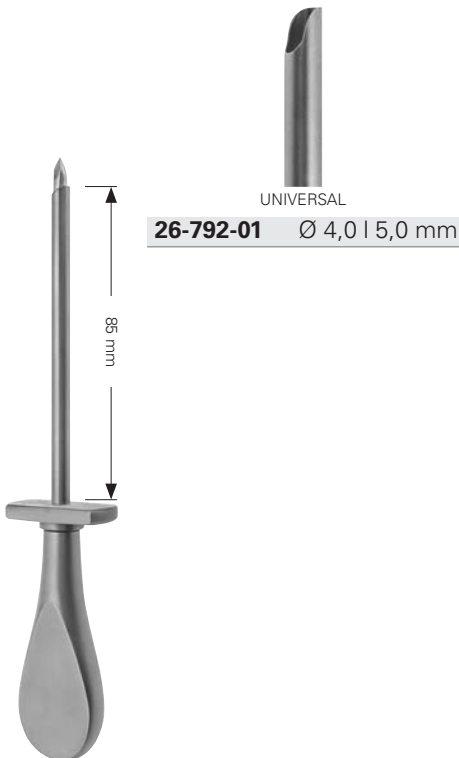

26-792-01 Ø 4,0 | 5,0 mm

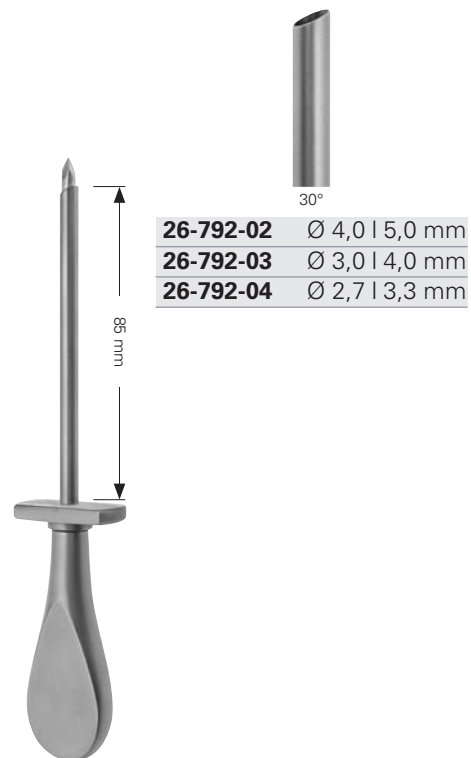

26-792-02 Ø 4,0 | 5,0 mm
26-792-03 Ø 3,0 | 4,0 mm
26-792-04 Ø 2,7 | 3,3 mm

26-792-01 16,0 cm, 6 1/4"

26-792-02 - 26-792-04 16,0 cm, 6 1/4"



26-795-01

mit Trokarspitze
 with trocar tip
 con punta de trocar
 con punta trequarti



26-795-02

stumpf
 blunt
 roma
 smusso

WIENER

26-795-01 18,0 cm, 7 "

WIENER

26-795-02 18,0 cm, 7 "

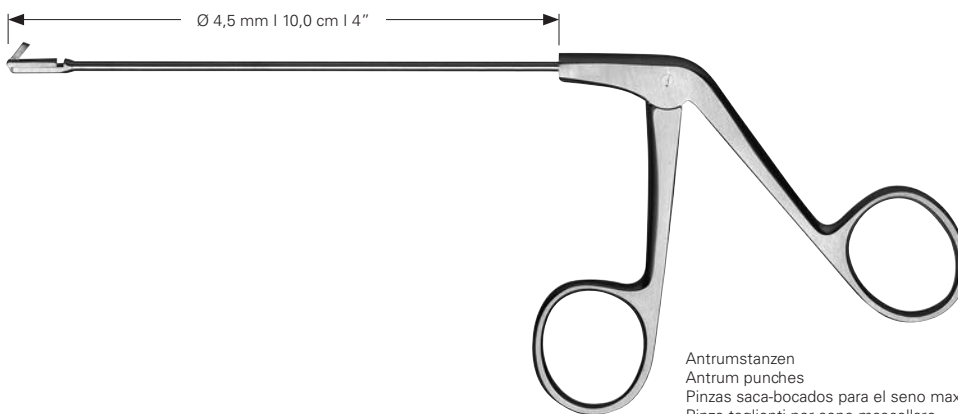

Antrumstanzen
 Antrum punches
 Pinzas saca-bocados para el seno maxilar
 Pinze taglienti per seno mascellare

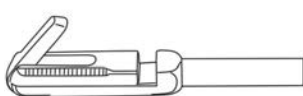

26-794-00 2,5 x 6,5 mm

nach oben schneidend
 cutting upwards
 corte hacia arriba
 taglio verso l'alto

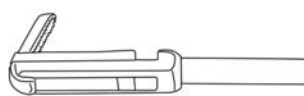

26-794-01 2,5 x 6,5 mm

nach rechts schneidend
 cutting right
 corte hacia la derecha
 taglio a destra

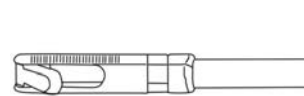

26-794-02 2,5 x 6,5 mm

nach links schneidend
 cutting left
 corte hacia a la izquierda
 taglio a sinistra

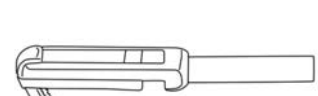

26-794-03 2,5 x 6,5 mm

nach unten schneidend
 cutting downwards
 corte hacia abajo
 taglio verso il basso



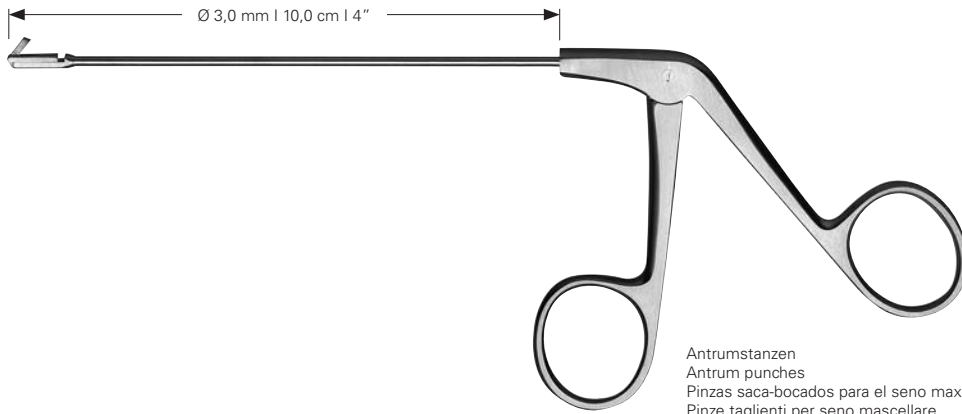

Antrumstanzen
Antrum punches
Pinzas saca-bocados para el seno maxilar
Pinze taglianti per seno mascellare



26-794-10 1,5 x 3,5 mm

nach oben schneidend
cutting upwards
corte hacia arriba
taglio verso l'alto



26-794-11 1,5 x 3,5 mm

nach rechts schneidend
cutting right
corte hacia la derecha
taglio a destra

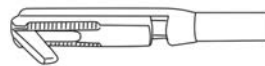

26-794-12 1,5 x 3,5 mm

nach links schneidend
cutting left
corte hacia a la izquierda
taglio a sinistra

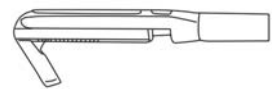

26-794-13 1,5 x 3,5 mm

nach unten schneidend
cutting downwards
corte hacia abajo
taglio verso il basso

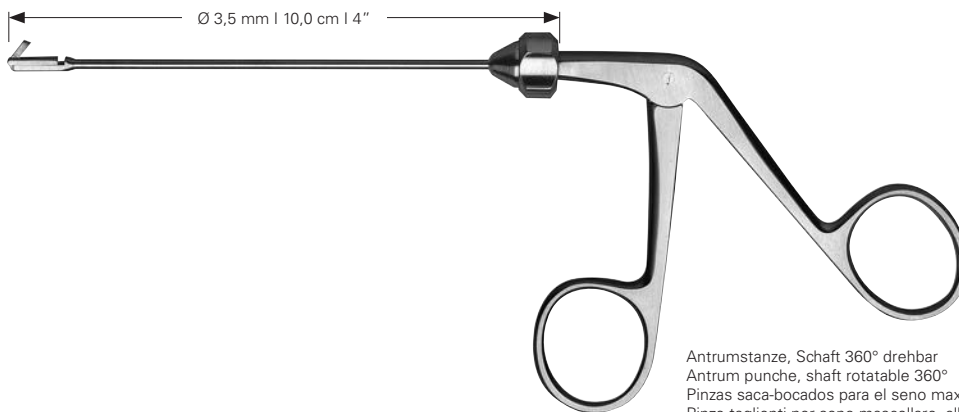

Antrumstanze, Schaft 360° drehbar
Antrum punche, shaft rotatable 360°
Pinzas saca-bocados para el seno maxilar, vástago girable 360°
Pinze taglianti per seno mascellare, albero rotante 360°

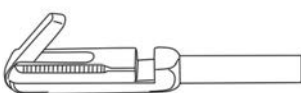

26-796-00 2,0 x 5,0 mm

rückwärts schneidend
cutting retrograde
corte retrógrado
taglianti retrograda

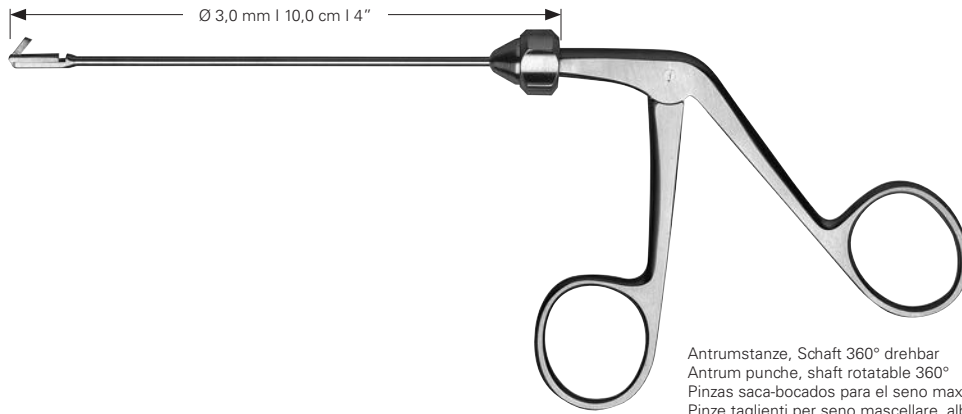

Antrumstanze, Schaft 360° drehbar
 Antrum punche, shaft rotatable 360°
 Pinzas saca-bocados para el seno maxilar, vástago girable 360°
 Pinze taglianti per seno mascellare, albero rotante 360°



26-796-10 1,5 x 3,5 mm

rückwärts schneidend
 cutting retrograde
 corte retrógrado
 taglianti retrograda

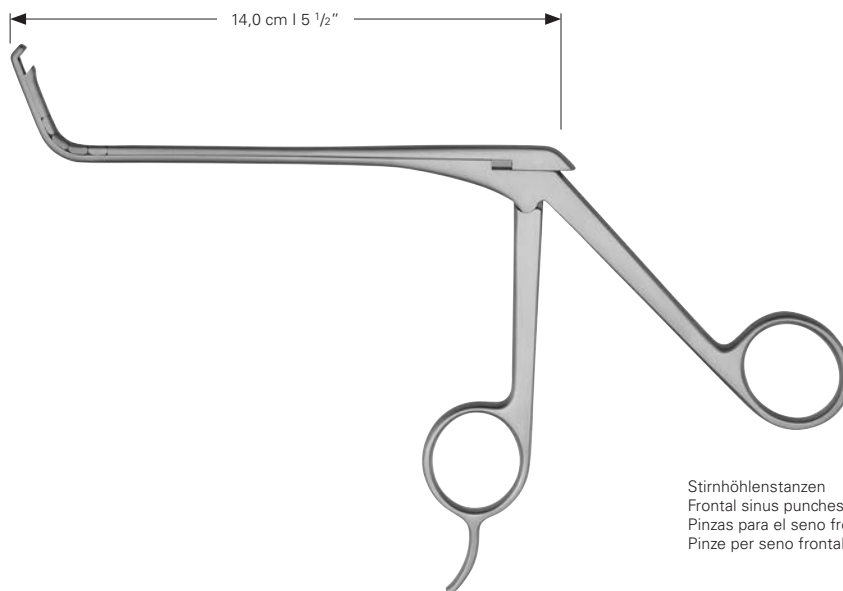

Stirnhöhlenstanzen
 Frontal sinus punches
 Pinzas para el seno frontal
 Pinze per seno frontale

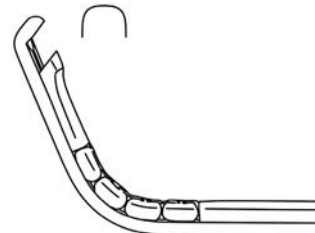
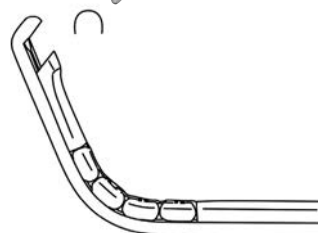
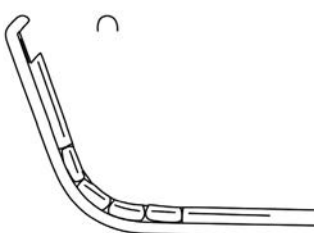

26-798-02 2,0 x 2,5 mm

26-798-03 3,0 x 3,5 mm

26-798-05 5,0 x 5,5 mm

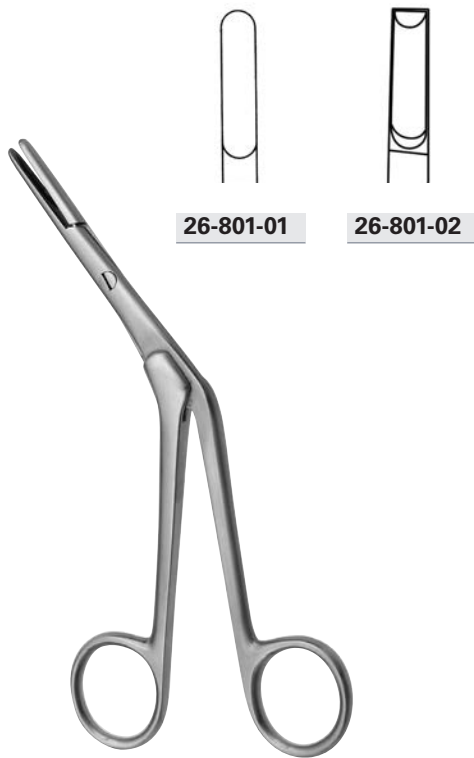

26-801-01

26-801-02

CRAIG

26-801-01 - 26-801-02 16,5 cm, 6 1/2"

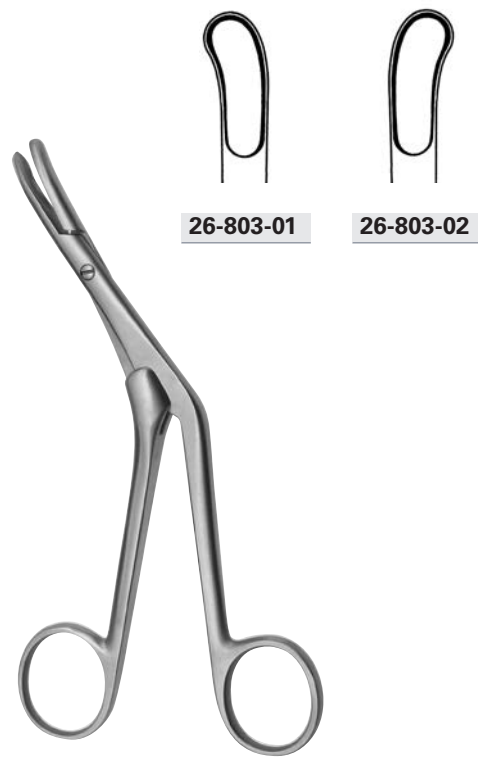

26-803-01

26-803-02

CRAIG

26-803-01 - 26-803-02 16,5 cm, 6 1/2"

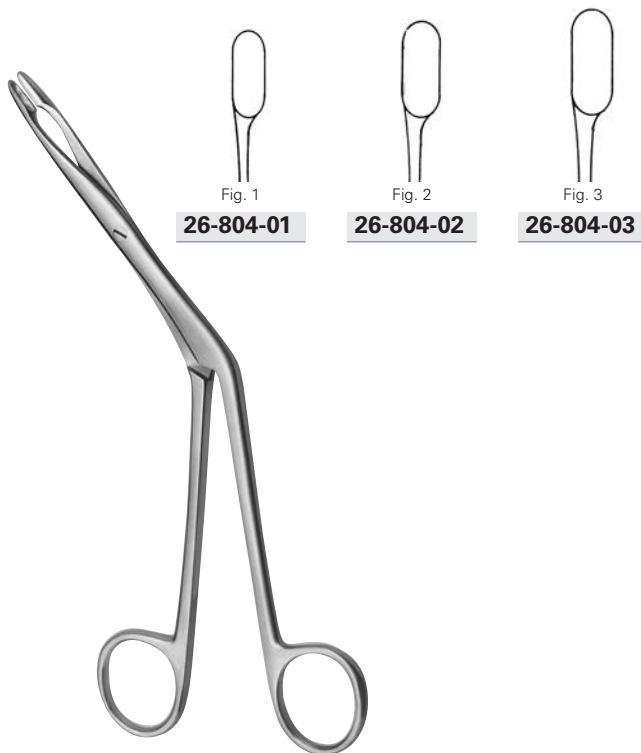

26-804-01

26-804-02

26-804-03

HEYMANN

26-804-01 - 26-804-03 18,0 cm, 7"

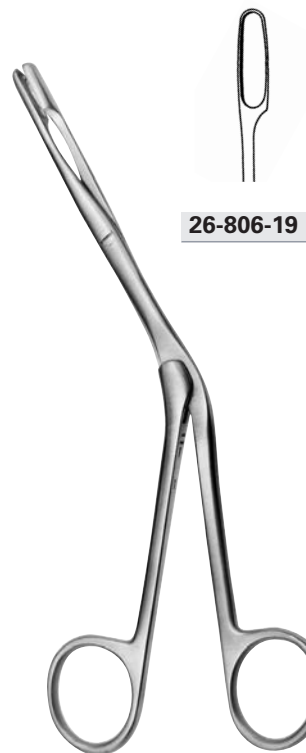

26-806-19

KNIGHT

26-806-19 18,0 cm, 7"



Fig. 1
26-807-01



Fig. 2
26-807-02

LUC

26-807-01 - 26-807-02 20,0 cm, 8 "

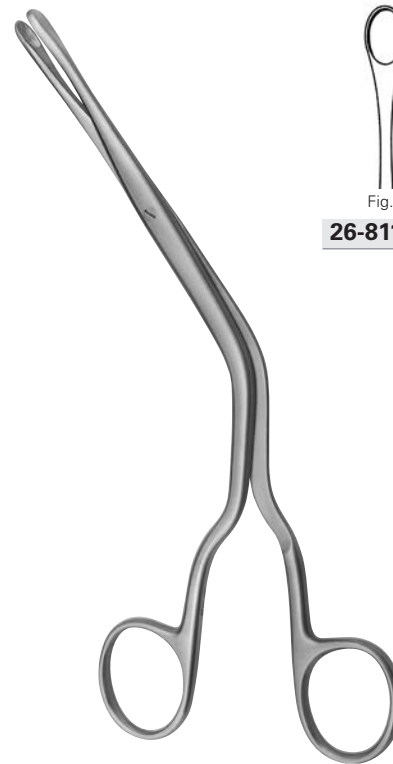

Fig. 1
26-811-01



Fig. 2
26-811-02

LUC

26-811-01 - 26-811-02 20,0 cm, 8 "



Fig. 1
26-813-01



Fig. 2
26-813-02



Fig. 3
26-813-03



Fig. 4
26-813-04

BRUENINGS

26-813-01 - 26-813-04 19,0 cm, 7 1/2 "



26-818-17 17,0 cm, 6 3/4"



BOIES

26-820-18 18,0 cm, 7"



GOLDMANN

26-822-20 20,0 cm, 8"



ASH

26-825-22 23,0 cm, 9"



COTTLE-WALSHAM

26-826-01 - 26-826-03 23,0 cm, 9"



Fig. 1

26-826-01

gerade
straight
recta
retto



Fig. 2

26-826-02

links
left
izquierda
sinistra



Fig. 3

26-826-03

rechts
right
derecha
destra



zerlegbar
 dismantable
 desmontable
 smontabile

COTTLE-WALSHAM

26-828-22 22,0 cm, 8 3/4"



26-829-03



26-829-04

KRESSNER

26-829-03 - 26-829-04 22,0 cm, 8 3/4"



26-830-01

aufeinanderschneidend
 spoon shaped jaws
 bocas cortantes
 taglio a filo

MIDDLETON-JANSEN

26-830-01 20,0 cm, 8"

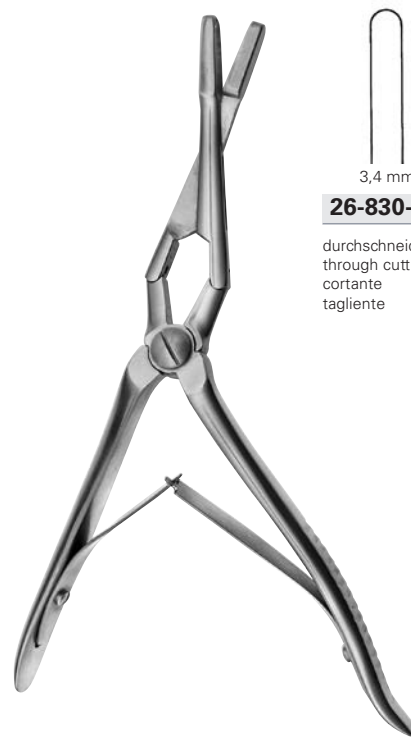

26-830-02

durchschneidend
 through cutting
 cortante
 tagliante

MIDDLETON-JANSEN

26-830-02 19,0 cm, 7 1/2"

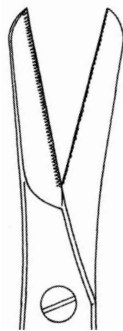

26-841-20



CAPLAN

26-841-20 20,0 cm, 8"

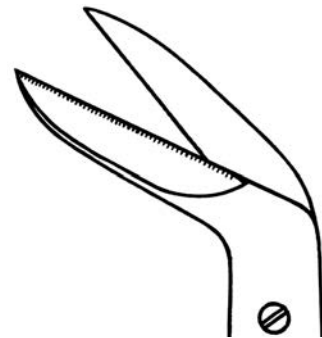

26-843-21



KILLIAN

26-843-21 20,0 cm, 8"



26-845-21



26-845-99

RUBIN

26-845-21 21,0 cm, 8 ¼"



26-846-19

23 x 31 mm

GELFOAM

26-846-19 19,0 cm, 7 ½"



26-848-20



26-848-20 20,0 cm, 8"



CUSHING-LANDOLT

26-900-01	Ø 15 x 70 mm
26-900-02	Ø 15 x 90 mm
26-900-03	Ø 15 x 110 mm



Spreizzange für Spekulas 26-900-01 - 26-900-03
Spreading forceps for speculas 26-900-01 - 26-900-03
Pinza retractor para espéculos 26-900-01 - 26-900-03
Pinza divaricatore per speculum 26-900-01 - 26-900-03

LANDOLT

26-900-21	21,0 cm, 8 ¼"
------------------	---------------



PAPAVERO-CASPAR

26-902-01	Ø 11 x 80 mm
26-902-02	Ø 13 x 90 mm
26-902-03	Ø 15 x 100 mm

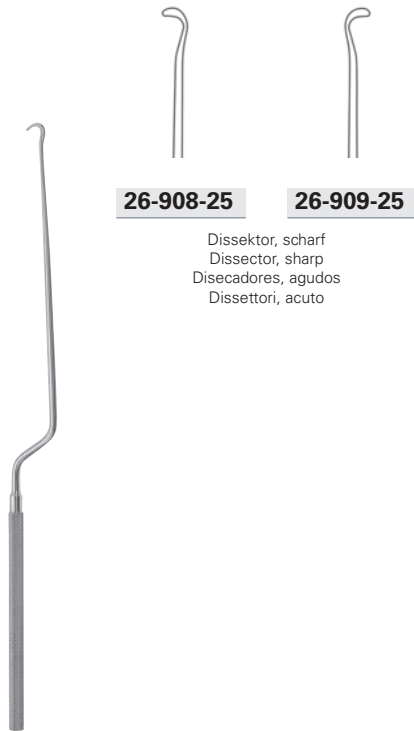

26-908-25

26-909-25

Dissektor, scharf
 Dissector, sharp
 Disecadores, agudos
 Dissettori, acuto

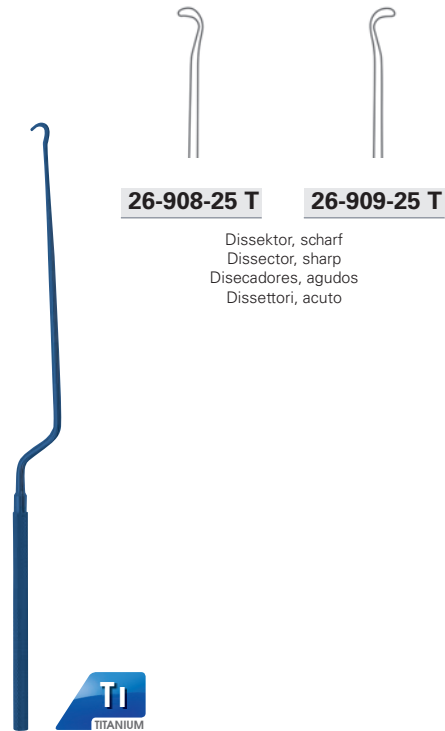

26-908-25 T

26-909-25 T

Dissektor, scharf
 Dissector, sharp
 Disecadores, agudos
 Dissettori, acuto



HARDY-FAHLBUSCH

26-908-25 - 26-909-25 24,5 cm, 9 2/3 "

HARDY-FAHLBUSCH

26-908-25 T - 26-909-25 T 24,5 cm, 9 2/3 "

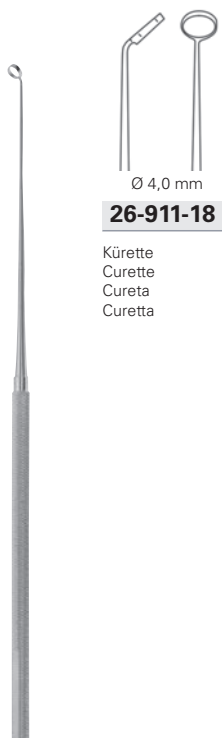

26-911-18

Kürette
 Curette
 Cureta
 Curetta

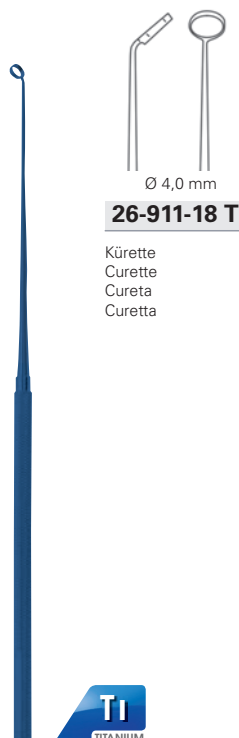

26-911-18 T

Kürette
 Curette
 Cureta
 Curetta

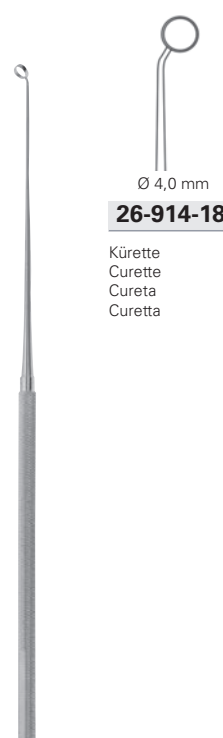

26-914-18

Kürette
 Curette
 Cureta
 Curetta

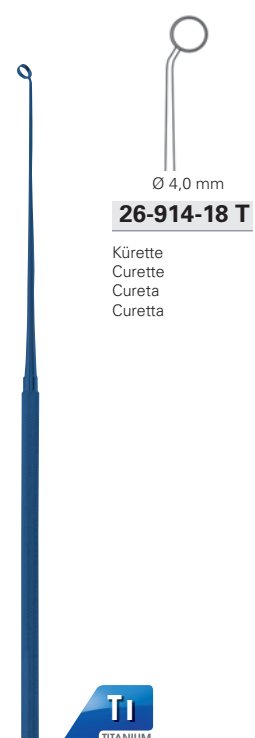

26-914-18 T

Kürette
 Curette
 Cureta
 Curetta



RAY

26-911-18 18,0 cm, 7 "

RAY

26-911-18 T 18,0 cm, 7 "

RAY

26-914-18 18,0 cm, 7 "

RAY

26-914-18 T 18,0 cm, 7 "

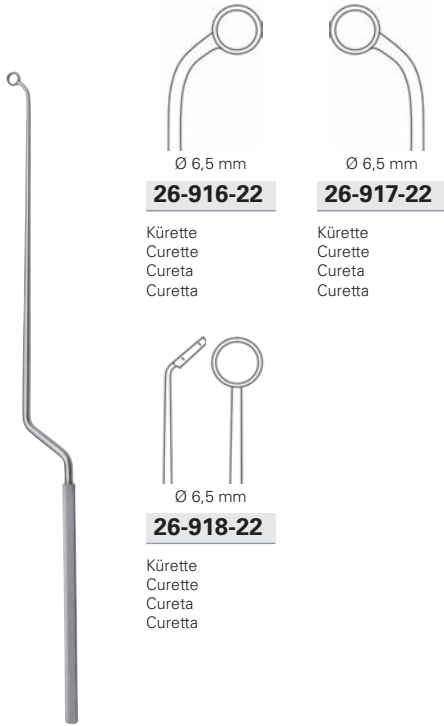

NICOLA

26-916-22 - 26-918-22 26,0 cm, 10 ¼ "

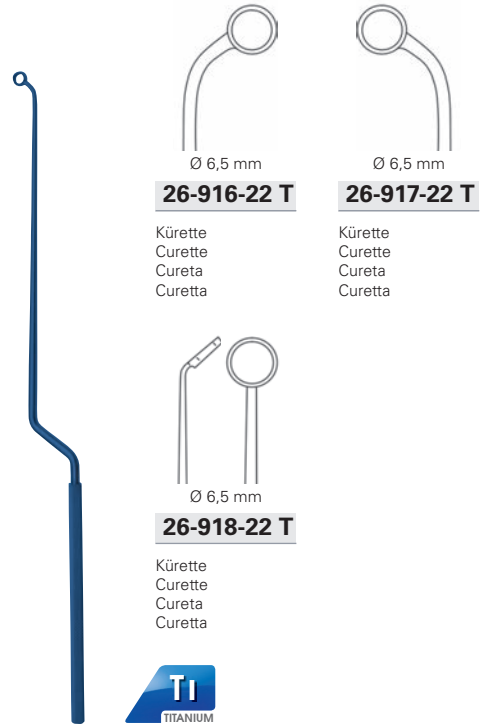

NICOLA

26-916-22 T - 26-918-22 T 26,0 cm, 10 ¼ "

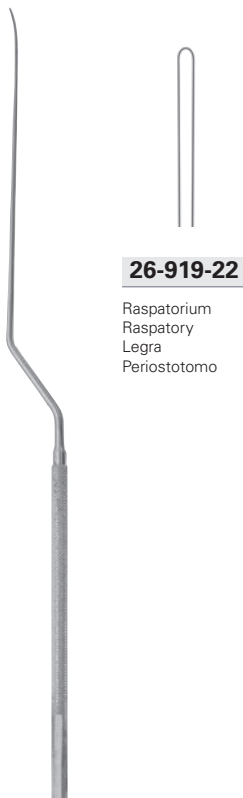

NICOLA

26-919-22 21,5 cm, 8 ½ "



NICOLA

26-919-22 T 21,5 cm, 8 ½ "



26-920-25

stumpf, rechts
blunt, right
romo, derecha
smusso, destra

26-921-25

stumpf, rechts
blunt, right
romo, derecha
smusso, destra

26-922-25

scharf, rechts
sharp, right
agudo, derecha
acuto, destra

26-923-25

scharf, rechts
sharp, right
agudo, derecha
acuto, destra

26-924-25

Implantationsgabel
Implant fork
Horquilla para implantar
Forchetta per impiantare

26-950-25

stumpf, links
blunt, left
romo, izquierdo
smusso, sinistra

26-951-25

stumpf, links
blunt, left
romo, izquierdo
smusso, sinistra

26-952-25

scharf, links
sharp, left
agudo, izquierdo
acuto, sinistra

26-953-25

scharf, links
sharp, left
agudo, izquierdo
acuto, sinistra

HARDY

26-920-25 - 26-953-25 24,5 cm, 9 2/3 "



26-920-25 T

stumpf, rechts
blunt, right
romo, derecha
smusso, destra

26-921-25 T

stumpf, rechts
blunt, right
romo, derecha
smusso, destra

26-922-25 T

scharf, rechts
sharp, right
agudo, derecha
acuto, destra

26-923-25 T

scharf, rechts
sharp, right
agudo, derecha
acuto, destra

26-950-25 T

stumpf, links
blunt, left
romo, izquierdo
smusso, sinistra

26-951-25 T

stumpf, links
blunt, left
romo, izquierdo
smusso, sinistra

26-952-25 T

scharf, links
sharp, left
agudo, izquierdo
acuto, sinistra

26-953-25 T

scharf, links
sharp, left
agudo, izquierdo
acuto, sinistra



HARDY

26-920-25 T - 26-953-25 T 24,5 cm, 9 2/3 "



26-925-25

stumpf, rechts
blunt, right
romo, derecha
smusso, destra



26-926-25

stumpf, rechts
blunt, right
romo, derecha
smusso, destra



26-955-25

stumpf, links
blunt, left
romo, izquierdo
smusso, sinistra



26-956-25

stumpf, links
blunt, left
romo, izquierdo
smusso, sinistra



26-930-26



26-927-26

Kürette
Curette
Cureta
Curetta



26-928-26

Löffel
Curette
Cucharilla
Curetta



26-929-26

Häkchen
Hook
Gancho
Uncini

biegsam
malleable
maleable
malleabile



LANDOLT

26-925-25 - 26-956-25 26,0 cm, 10 1/4 "

HASOBUCCHI

26-930-26 26,0 cm, 10 1/4 "



26-925-25 T

stumpf, rechts
blunt, right
romo, derecha
smusso, destra



26-926-25 T

stumpf, rechts
blunt, right
romo, derecha
smusso, destra



26-955-25 T

stumpf, links
blunt, left
romo, izquierdo
smusso, sinistra



26-956-25 T

stumpf, links
blunt, left
romo, izquierdo
smusso, sinistra



26-929-26 T

Häkchen
Hook
Gancho
Uncini



LANDOLT

26-925-25 T - 26-956-25 T 26,0 cm, 10 1/4 "

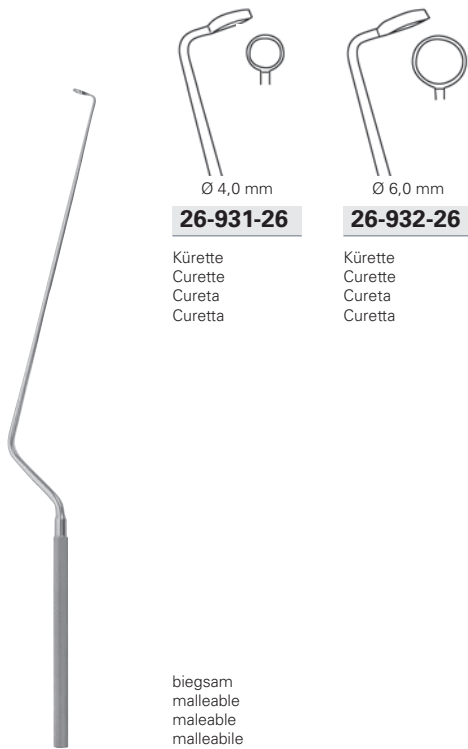

Ø 4,0 mm
26-931-26

Kürette
 Curette
 Cureta
 Curetta

Ø 6,0 mm
26-932-26

Kürette
 Curette
 Cureta
 Curetta

biegsam
 malleable
 maleable
 malleabile

HARDY

26-931-26 - 26-932-26 26,0 cm, 10 ¼"

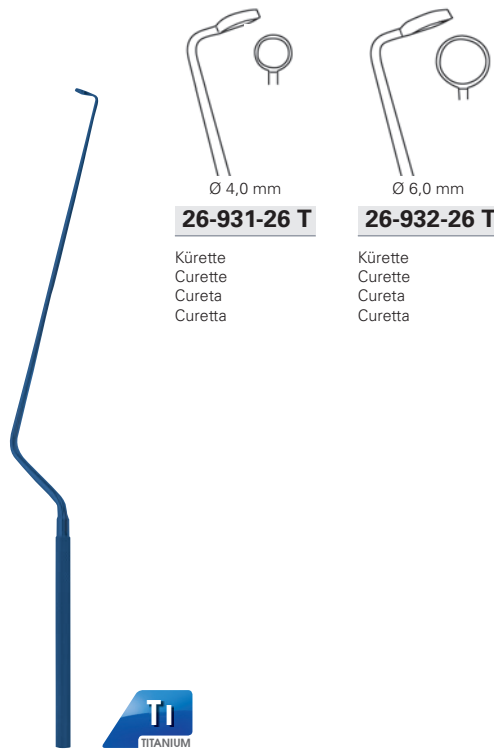

Ø 4,0 mm
26-931-26 T

Kürette
 Curette
 Cureta
 Curetta

Ø 6,0 mm
26-932-26 T

Kürette
 Curette
 Cureta
 Curetta

Ti
 TITANIUM

HARDY

26-931-26 T - 26-932-26 T 26,0 cm, 10 ¼"

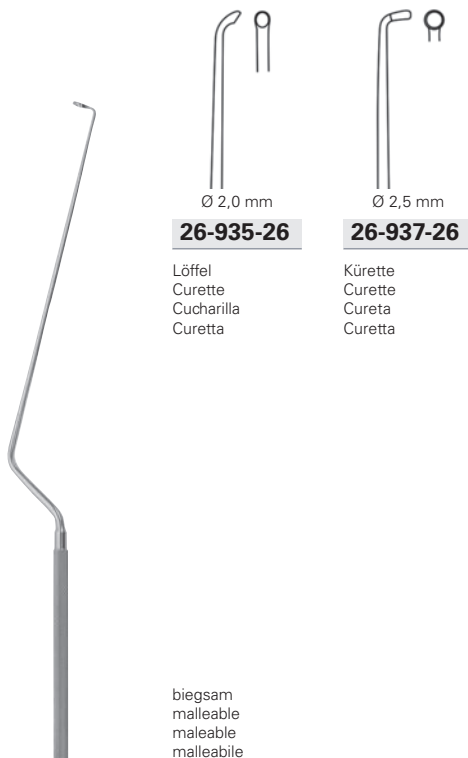

Ø 2,0 mm
26-935-26

Löffel
 Curette
 Cucharilla
 Curetta

Ø 2,5 mm
26-937-26

Kürette
 Curette
 Cureta
 Curetta

biegsam
 malleable
 maleable
 malleabile

FAHLBUSCH

26-935-26 - 26-937-26 26,0 cm, 10 ¼"



Ø 2,0 mm
26-935-26 T

Löffel
 Curette
 Cucharilla
 Curetta

Ø 2,5 mm
26-937-26 T

Kürette
 Curette
 Cureta
 Curetta

Ti
 TITANIUM

FAHLBUSCH

26-935-26 T - 26-937-26 T 26,0 cm, 10 ¼"

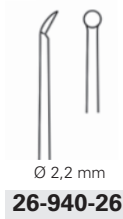

Raspatorium
Raspatory
Legra
Periostotomo

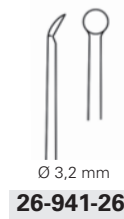

Raspatorium
Raspatory
Legra
Periostotomo

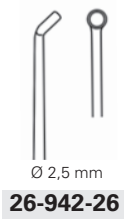

Kürette
Curette
Cureta
Curetta

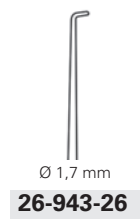

Häkchen
Hook
Gancho
Uncini

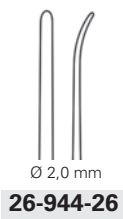

Dissektor
Dissector
Disecadores
Dissettori

LANDOLT-REULEN

26-940-26 - 26-944-26 26,0 cm, 10 ¼ "

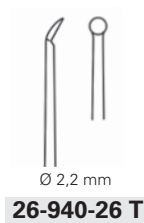

Raspatorium
Raspatory
Legra
Periostotomo

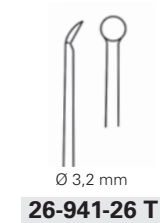

Raspatorium
Raspatory
Legra
Periostotomo

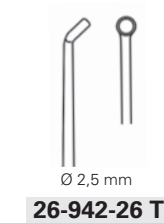

Kürette
Curette
Cureta
Curetta

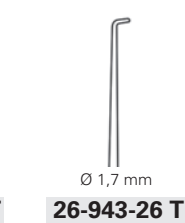

Häkchen
Hook
Gancho
Uncini

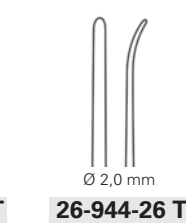

Dissektor
Dissector
Disecadores
Dissettori



LANDOLT-REULEN

26-940-26 T - 26-944-26 T 26,0 cm, 10 ¼ "



27



HNO-Instrumente

ENT Instruments

Instrumentos para ORL

Strumenti per ORL



27



Mikro Instrumente

Micro Instruments

Instrumentos de micro

Strumentario micro

Fordern Sie unser Spezialprospekt an
Please ask for our special catalogue
No duden pedirnos más catálogos especiales
Chiedete i nostri cataloghi speciali



72



Endoskope

Endoscopes

Endoscopios

Endoscopi

Fordern Sie unser Spezialprospekt an
Please ask for our special catalogue
No duden pedirnos más catálogos especiales
Chiedete i nostri cataloghi speciali

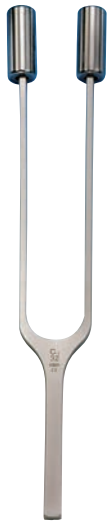

mit Dämpfer
with clamp
con sordina
con sordina



mit Fuß
with foot
con pie
con pie

HARTMANN (FRENCH)

27-000-01	C ₋₂	16 Hz
27-000-02	C ₋₁	32 Hz
27-000-03	C	64 Hz
27-000-04	c	128 Hz
27-000-05	c ¹	256 Hz

HARTMANN

27-001-01	c	128 Hz
27-001-02	c ¹	256 Hz
27-001-03	c ²	512 Hz
27-001-04	c ³	1024 Hz
27-001-05	c ⁴	2048 Hz
27-001-06	c ⁵	4096 Hz

LUCAE

27-004-01	c	128 Hz
27-004-02	c ¹	256 Hz
27-004-03	c ²	512 Hz
27-004-04	c ³	1024 Hz
27-004-05	c ⁴	2048 Hz
27-004-06	c ⁵	4096 Hz



mit Dämpfer
with clamp
con sordina
con sordina

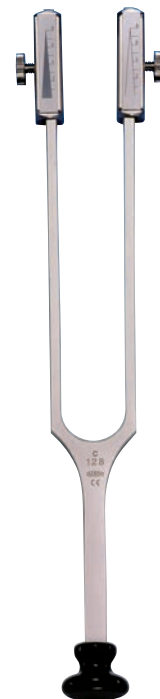

mit Dämpfer C 64 Hz
ohne Dämpfer c 128 Hz
with clamp C 64 Hz
without clamp c 128 Hz
con sordina C 64 Hz
sin sordina 128 Hz
con sordina C 64 Hz
senza sordina 128 Hz

27-005-01	C	64 Hz
27-005-02	c	128 Hz
27-005-03	c ¹	256 Hz

27-005-04	c ²	512 Hz
27-005-05	c ³	1024 Hz
27-005-06	c ⁴	2048 Hz
27-005-07	c ⁵	4096 Hz

RYDEL-SEIFFER

27-008-01

Stimmgabeln
Tuning forks
Diapasónes
Diapason

einstellbar bis **h 240 Hz**
adjustable up to **h 240 Hz**
ajustable hasta **h 240 Hz**
regolabili fino ad **h 240 Hz**



mit Fuß
with foot
con pie
con pie

27-010-01 a¹ 440 Hz



mit Fuß
with foot
con pie
con pie

LUCAE

27-012-01 c 128 Hz

einstellbar bis **h 240 Hz**
adjustable up to **h 240 Hz**
ajustable hasta **h 240 Hz**
regolabili fino ad **h 240 Hz**

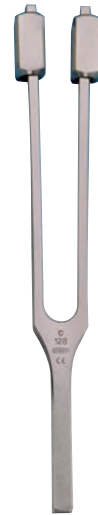

HARTMANN

27-013-01 c 128 Hz

einstellbar bis **g 194 Hz**
adjustable up to **g 194 Hz**
ajustable hasta **g 194 Hz**
regolabili fino ad **g 194 Hz**



mit Fuß
with foot
con pie
con pie

KOENIG

27-015-01 A 109 Hz



Stimmgabel für neurologische Untersuchungen, mit Reflexhammer, Nadelrad, Pinsel und Nadel

Tuning fork for neurological examinations, with percussion hammer, pin wheel, brush and needle

Diapason para exámenes neurologicos, con martillo para reflejo, rueda de agujas, pincel y aguja

Diapason per esami neurologici, con martello di riflesso, ruota (ingranaggio) per l'ago, pennello ed ago

27-018-00 c 275 Hz



27-005-00 SET

komplett, bestehend aus: 27-005-02, -03, -04, -05, -06
complete, consisting of: 27-005-02, -03, -04, -05, -06
completo, compuesto de: 27-005-02, -03, -04, -05, -06
completo, composto da: 27-005-02, -03, -04, -05, -06

HARTMANN

27-007-00 SET

komplett, bestehend aus: 27-001-03, 27-001-04, 27-001-05, 27-000-04, 27-000-05
complete, consisting of: 27-001-03, 27-001-04, 27-001-05, 27-000-04, 27-000-05
completo, compuesto de: 27-001-03, 27-001-04, 27-001-05, 27-000-04, 27-000-05
completo, composto da: 27-001-03, 27-001-04, 27-001-05, 27-000-04, 27-000-05

HARTMANN

27-007-01 SET

komplett, bestehend aus: 27-001-03, 27-001-04, 27-001-05, 27-001-06, 27-000-04, 27-000-05
complete, consisting of: 27-001-03, 27-001-04, 27-001-05, 27-001-06, 27-000-04, 27-000-05
completo, compuesto de: 27-001-03, 27-001-04, 27-001-05, 27-001-06, 27-000-04, 27-000-05
completo, composto da: 27-001-03, 27-001-04, 27-001-05, 27-001-06, 27-000-04, 27-000-05

HARTMANN

27-008-00 SET

komplett, bestehend aus: 27-001-03, 27-001-04, 27-001-05, 27-001-06, 27-000-02, 27-000-03, 27-000-04, 27-000-05
complete, consisting of: 27-001-03, 27-001-04, 27-001-05, 27-001-06, 27-000-02, 27-000-03, 27-000-04, 27-000-05
completo, compuesto de: 27-001-03, 27-001-04, 27-001-05, 27-001-06, 27-000-02, 27-000-03, 27-000-04, 27-000-05
completo, composto da: 27-001-03, 27-001-04, 27-001-05, 27-001-06, 27-000-02, 27-000-03, 27-000-04, 27-000-05



Lärmtrommel mit Ohrolive
Noise drum with ear olive
Ensordecedor con oliva
Tamburo rumoroso con oliva



BARANY

27-020-00



Fig. 0

27-031-00

Fig. 1

27-031-01

Fig. 2

27-031-02

Fig. 3

27-031-03

Fig. 4

27-031-04

Fig. 5

27-031-05

HARTMANN

27-031-00 - 27-031-05 15,0 cm, 6"



POLITZER

27-034-04 Ø 4,0 mm



POLITZER

27-034-15 Ø 15,0 mm



POLITZER

27-034-17 Ø 17,0 mm



POLITZER

27-034-22 Ø 22,0 mm



POLITZER

27-034-50



POLITZER

27-034-03



POLITZER

27-034-00 SET

Komplett, bestehend aus:

1 Gummibirne	27-034-50
1 Einsteckkonus	27-034-03
1 Nasenolive, Ø 15,0 mm	27-034-15
1 Nasenolive, Ø 17,0 mm	27-034-17
1 Nasenolive, Ø 12,0 mm	27-034-22

Complete, consisting of:

1 Rubber bulb	27-034-50
1 Connecting nozzle	27-034-03
1 Nose olive, Ø 15,0 mm	27-034-15
1 Nose olive, Ø 17,0 mm	27-034-17
1 Nose olive, Ø 12,0 mm	27-034-22

Completo, compuesto de:

1 Pera de goma	27-034-50
1 Cono de conexión	27-034-03
1 Oliva nasal, Ø 15,0 mm	27-034-15
1 Oliva nasal, Ø 17,0 mm	27-034-17
1 Oliva nasal, Ø 12,0 mm	27-034-22

Completo, composto da:

1 Pera in gomma	27-034-50
1 Cono di connessione	27-034-03
1 Oliva nasale, Ø 15,0 mm	27-034-15
1 Oliva nasale, Ø 17,0 mm	27-034-17
1 Oliva nasale, Ø 12,0 mm	27-034-22



POLITZER

27-034-01 SET

Komplett, bestehend aus:

1 Gummibirne	27-034-50
1 Einsteckkonus	27-034-03
1 Ohrolive, Ø 4,0 mm	27-034-04
1 Nasenolive, Ø 15,0 mm	27-034-15
1 Nasenolive, Ø 17,0 mm	27-034-17
1 Nasenolive, Ø 12,0 mm	27-034-22

Complete, consisting of:

1 Rubber bulb	27-034-50
1 Connecting nozzle	27-034-03
1 Ear olive, Ø 4,0 mm	27-034-04
1 Nose olive, Ø 15,0 mm	27-034-15
1 Nose olive, Ø 17,0 mm	27-034-17
1 Nose olive, Ø 12,0 mm	27-034-22

Completo, compuesto de:

1 Pera de goma	27-034-50
1 Cono de conexión	27-034-03
1 Oliva auricular, Ø 4,0mm	27-034-04
1 Oliva nasal, Ø 15,0 mm	27-034-15
1 Oliva nasal, Ø 17,0 mm	27-034-17
1 Oliva nasal, Ø 12,0 mm	27-034-22

Completo, composto da:

1 Pera in gomma	27-034-50
1 Cono di connessione	27-034-03
1 Oliva auricolare, Ø4,0mm	27-034-04
1 Oliva nasale, Ø 15,0 mm	27-034-15
1 Oliva nasale, Ø 17,0 mm	27-034-17
1 Oliva nasale, Ø 12,0 mm	27-034-22



POLITZER-ASEPTIC

27-034-02 SET

Komplett, bestehend aus:

1 Kunststoffbox	
1 Gummibirne	27-034-50
1 Einsteckkonus	27-034-03
1 Ohrolive, Ø 4,0 mm	27-034-04
1 Nasenolive, Ø 15,0 mm	27-034-15
1 Nasenolive, Ø 17,0 mm	27-034-17
1 Nasenolive, Ø 12,0 mm	27-034-22

Complete, consisting of:

1 Plastic box	
1 Rubber bulb	27-034-50
1 Connecting nozzle	27-034-03
1 Ear olive, Ø 4,0 mm	27-034-04
1 Nose olive, Ø 15,0 mm	27-034-15
1 Nose olive, Ø 17,0 mm	27-034-17
1 Nose olive, Ø 12,0 mm	27-034-22

Completo, compuesto de:

1 Caja de plástico	
1 Pera de goma	27-034-50
1 Cono de conexión	27-034-03
1 Oliva auricular, Ø 4,0mm	27-034-04
1 Oliva nasal, Ø 15,0 mm	27-034-15
1 Oliva nasal, Ø 17,0 mm	27-034-17
1 Oliva nasal, Ø 12,0 mm	27-034-22

Completo, composto da:

1 Contenitori di plastica	
1 Pera in gomma	27-034-50
1 Cono di connessione	27-034-03
1 Oliva auricolare, Ø4,0mm	27-034-04
1 Oliva nasale, Ø 15,0 mm	27-034-15
1 Oliva nasale, Ø 17,0 mm	27-034-17
1 Oliva nasale, Ø 12,0 mm	27-034-22

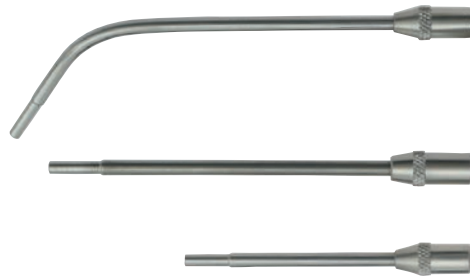

27-036-13 130 mm

27-036-11 110 mm

27-036-08 80 mm

KABIERSKE

27-036-00 SET

Komplett, bestehend aus:

1 Ventilball	27-036-50
1 Flasche	27-036-01
1 Ohrkanüle, 80 mm	27-036-08
1 Ohrkanüle, 110 mm	27-036-11
1 Ohrkanüle, 130 mm	27-036-13
1 Pulverbläser	27-036-40

Complete, consisting of:

1 Valve rubber bulb	27-036-50
1 Bottle	27-036-01
1 Ear cannula, 80 mm	27-036-08
1 Ear cannula, 110 mm	27-036-11
1 Ear cannula, 130 mm	27-036-13
1 Atomizer	27-036-40



Completo, compuesto de:

1 Pera de goma con valva	27-036-50
1 Frasco	27-036-01
1 Cánula auricular, 80 mm	27-036-08
1 Cánula auricular, 110 mm	27-036-11
1 Cánula auricular, 130 mm	27-036-13
1 Pulverizador	27-036-40

Completo, composto da:

1 Pallone gomma con valva	27-036-50
1 Bottiglia	27-036-01
1 Cannula auricolare 80mm	27-036-08
1 Cannula auricolare 110mm	27-036-11
1 Cannula auricolare 130mm	27-036-13
1 Insuffiatore polvere	27-036-40

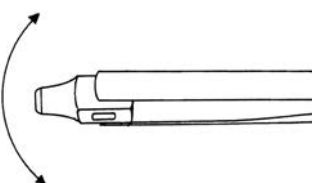

UNIVERSAL

27-039-00

für Rhinologie
for Rhinology
para Rinología
per Rhinologia

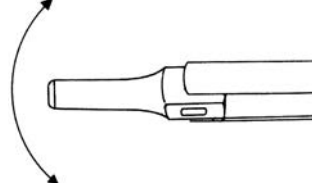

UNIVERSAL

27-040-00

für Otologie
for Otolology
para Otolología
per Otolologia



komplett
complete
completo
completo

27-044-05	50 ml
27-044-07	75 ml
27-044-10	100 ml
27-044-15	150 ml



27-041-11



27-041-12

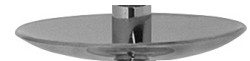

27-041-13



selbstfüllend in Kunststoffflasche
self filling in plastic pouch
auto-rellena en bolsa plástica
auto-riempente in borsa di plastica

27-042-00 10 ml

komplett
complete
completo
completo



Spritze
Syringe
Jeringa
Siringa

27-042-01



Schuttteller
Protecting disc
Disco protector
Disco protettivo

27-042-05



Gewindeansatz
Threaded tip
Punta de rosca
Punta filettata

27-042-09



Saugansatz
Suction nozzle
Pieza de succión
Aspiratore

27-042-04



Geknöpfter Ansatz
Button end tip
Punta de botón
Punta a bottone

27-042-08



Verbindungsschlauch
Flexible tube
Tubo de conexión
Tubo di connessione

27-042-03



Konischer Ansatz
Conical tip
Punta cónica
Punta conica

27-042-07



Ventilaufsatz
Valve attachment
Válvula de conexión
Valvola di connessione

27-042-02



Metallolive
Metal olive
Oliva metálica
Oliva in metallo

27-042-06

Fig. 1



4,5 x 5,5 mm

27-101-01

Fig. 2



5,5 x 6,5 mm

27-101-02

Fig. 3



6,5 x 7,5 mm

27-101-03

Fig. 4



7,5 x 8,5 mm

27-101-04

Fig. 5



8,5 x 9,5 mm

27-101-05

Fig. 6



9,5 x 10,5 mm

27-101-06



CR B
CHROME

AL
ALUMINIUM

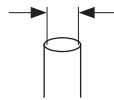

Innendurchmesser
Inside diameter
Diámetro interior
Diámetro interno

ZOELLNER

27-101-01	Fig. 1 38 mm
27-101-02	Fig. 2 38 mm
27-101-03	Fig. 3 38 mm
27-101-04	Fig. 4 38 mm
27-101-05	Fig. 5 38 mm
27-101-06	Fig. 6 38 mm

ZOELLNER

27-101-00	Set
bestehend aus:	Fig. 1 - Fig. 6 (6 Stück)
consisting of:	Fig. 1 - Fig. 6 (6 pieces)
compuesto de:	Fig. 1 - Fig. 6 (6 piezas)
composto da:	Fig. 1 - Fig. 6 (6 pezzi)

ZOELLNER

27-101-50	Set
bestehend aus:	Fig. 1 - Fig. 3 (3 Stück)
consisting of:	Fig. 1 - Fig. 3 (3 pieces)
compuesto de:	Fig. 1 - Fig. 3 (3 piezas)
composto da:	Fig. 1 - Fig. 3 (3 pezzi)

ZOELLNER

27-101-60	Set
bestehend aus:	Fig. 4 - Fig. 6 (3 Stück)
consisting of:	Fig. 4 - Fig. 6 (3 pieces)
compuesto de:	Fig. 4 - Fig. 6 (3 piezas)
composto da:	Fig. 4 - Fig. 6 (3 pezzi)

Fig. 1



3,3 mm

27-102-01

Fig. 2



4,3 mm

27-102-02

Fig. 3



4,8 mm

27-102-03

Fig. 4



5,3 mm

27-102-04

Fig. 5



5,8 mm

27-102-05

Fig. 6



6,3 mm

27-102-06

Fig. 7



6,7 mm

27-102-07

Fig. 8



7,2 mm

27-102-08

Fig. 9



7,7 mm

27-102-09



STEEL
STAINLESS

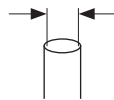

Innendurchmesser
Inside diameter
Diámetro interior
Diámetro interno

FARRIOR

27-102-01	Fig. 1 43 mm
27-102-02	Fig. 2 43 mm
27-102-03	Fig. 3 43 mm
27-102-04	Fig. 4 43 mm
27-102-05	Fig. 5 43 mm
27-102-06	Fig. 6 43 mm
27-102-07	Fig. 7 43 mm
27-102-08	Fig. 8 43 mm
27-102-09	Fig. 9 43 mm

FARRIOR

27-102-00	Set
bestehend aus:	Fig. 1 - Fig. 9 (9 Stück)
consisting of:	Fig. 1 - Fig. 9 (9 pieces)
compuesto de:	Fig. 1 - Fig. 9 (9 piezas)
composto da:	Fig. 1 - Fig. 9 (9 pezzi)

Fig. 1



2,0 mm

27-103-02

Fig. 2



3,0 mm

27-103-03

Fig. 3



4,0 mm

27-103-04

Fig. 4



5,0 mm

27-103-05

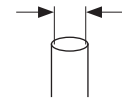

Innendurchmesser
Inside diameter
Diámetro interior
Diámetro interno

POLITZER

27-103-02	Fig. 1 27 mm
27-103-03	Fig. 2 27 mm
27-103-04	Fig. 3 27 mm
27-103-05	Fig. 4 27 mm

POLITZER

27-103-00	Set
bestehend aus:	Fig. 1 - Fig. 3 (3 Stück)
consisting of:	Fig. 1 - Fig. 3 (3 pieces)
compuesto de:	Fig. 1 - Fig. 3 (3 piezas)
composto da:	Fig. 1 - Fig. 3 (3 pezzi)

POLITZER

27-103-01	Set
bestehend aus:	Fig. 1 - Fig. 4 (4 Stück)
consisting of:	Fig. 1 - Fig. 4 (4 pieces)
compuesto de:	Fig. 1 - Fig. 4 (4 piezas)
composto da:	Fig. 1 - Fig. 4 (4 pezzi)

Fig. 1



1,7 mm

27-103-18

Fig. 2



3,2 mm

27-103-32

Fig. 3



4,7 mm

27-103-46

Fig. 1



1,7 mm

27-103-58

Fig. 2



3,2 mm

27-103-72

Fig. 3



4,7 mm

27-103-87

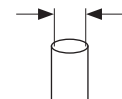

Innendurchmesser
Inside diameter
Diámetro interior
Diámetro interno

HARTMANN

27-103-18	Fig. 1
27-103-32	Fig. 2
27-103-46	Fig. 3

HARTMANN

27-103-10	Set
bestehend aus:	Fig. 1 - Fig. 3 (3 Stück)
consisting of:	Fig. 1 - Fig. 3 (3 pieces)
compuesto de:	Fig. 1 - Fig. 3 (3 piezas)
composto da:	Fig. 1 - Fig. 3 (3 pezzi)

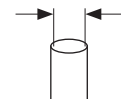







Innendurchmesser
Inside diameter
Diámetro interior
Diámetro interno

HARTMANN

27-103-58	Fig. 1
27-103-72	Fig. 2
27-103-87	Fig. 3

HARTMANN

27-103-50	Set
bestehend aus:	Fig. 1 - Fig. 3 (3 Stück)
consisting of:	Fig. 1 - Fig. 3 (3 pieces)
compuesto de:	Fig. 1 - Fig. 3 (3 piezas)
composto da:	Fig. 1 - Fig. 3 (3 pezzi)

Fig. 1	Fig. 2	Fig. 3	Fig. 4	Fig. 5	Fig. 6	Fig. 9
						
2,0 mm	3,0 mm	4,0 mm	5,5 mm	6,5 mm	8,0 mm	9,0 mm
27-104-25	27-104-03	27-104-04	27-104-05	27-104-06	27-104-08	27-104-09

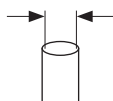

Innendurchmesser
Inside diameter
Diámetro interior
Diametro interno

HARTMANN

27-104-25	Fig. 1
27-104-03	Fig. 2
27-104-04	Fig. 3
27-104-05	Fig. 4
27-104-06	Fig. 5
27-104-08	Fig. 6
27-104-09	Fig. 7

HARTMANN









27-104-00	Set
bestehend aus:	Fig. 3 - Fig. 6 I (4 Stück)
consisting of:	Fig. 3 - Fig. 6 I (4 pieces)
compuesto de:	Fig. 3 - Fig. 6 I (4 piezas)
composto da:	Fig. 3 - Fig. 6 I (4 pezzi)

HARTMANN

27-104-01	Set
bestehend aus:	Fig. 4 - Fig. 6 I (3 Stück)
consisting of:	Fig. 4 - Fig. 6 I (3 pieces)
compuesto de:	Fig. 4 - Fig. 6 I (3 piezas)
composto da:	Fig. 4 - Fig. 6 I (3 pezzi)



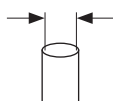

HARTMANN

27-104-02	Set
bestehend aus:	Fig. 2 - Fig. 4 I (3 Stück)
consisting of:	Fig. 2 - Fig. 4 I (3 pieces)
compuesto de:	Fig. 2 - Fig. 4 I (3 piezas)
composto da:	Fig. 2 - Fig. 4 I (3 pezzi)

Fig. 1	Fig. 2	Fig. 3	Fig. 4	Fig. 5	Fig. 6	Fig. 7	Fig. 8
							
3,0 mm	3,5 mm	4,0 mm	4,5 mm	5,0 mm	5,5 mm	6,0 mm	6,5 mm
27-104-30	27-104-35	27-104-40	27-104-45	27-104-50	27-104-55	27-104-60	27-104-65



Innendurchmesser
Inside diameter
Diámetro interior
Diametro interno

Fig. 9	Fig. 10	Fig. 11	Fig. 12
			
7,0 mm	7,5 mm	8,0 mm	9,0 mm
27-104-70	27-104-75	27-104-80	27-104-90

HARTMANN

27-104-30	Fig. 1
27-104-35	Fig. 2
27-104-40	Fig. 3
27-104-45	Fig. 4
27-104-50	Fig. 5
27-104-55	Fig. 6
27-104-60	Fig. 7
27-104-65	Fig. 8
27-104-70	Fig. 9
27-104-75	Fig. 10
27-104-80	Fig. 11
27-104-90	Fig. 12

HARTMANN

27-104-92	Set
bestehend aus:	Fig. 11 - Fig. 12 I (2 Stück)
consisting of:	Fig. 11 - Fig. 12 I (2 pieces)
compuesto de:	Fig. 11 - Fig. 12 I (2 piezas)
composto da:	Fig. 11 - Fig. 12 I (2 pezzi)

HARTMANN

27-104-93	Set
bestehend aus:	Fig. 1, 3, 6 I (3 Stück)
consisting of:	Fig. 1, 3, 6 I (3 pieces)
compuesto de:	Fig. 1, 3, 6 I (3 piezas)
composto da:	Fig. 1, 3, 6 I (3 pezzi)

HARTMANN

27-104-94	Set
bestehend aus:	Fig. 1, 3, 6, 9 I (4 Stück)
consisting of:	Fig. 1, 3, 6, 9 I (4 pieces)
compuesto de:	Fig. 1, 3, 6, 9 I (4 piezas)
composto da:	Fig. 1, 3, 6, 9 I (4 pezzi)

Fig. 1



3,0 mm

27-105-03

Fig. 2



4,0 mm

27-105-04

Fig. 3



5,0 mm

27-105-05

Fig. 4



7,0 mm

27-105-07

Fig. 5



8,0 mm

27-105-08

Fig. 6



9,0 mm

27-105-09

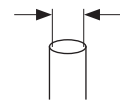

Innendurchmesser
Inside diameter
Diámetro interior
Diámetro interno

HARTMANN

27-105-03	Fig. 1
27-105-04	Fig. 2
27-105-05	Fig. 3
27-105-07	Fig. 4
27-105-08	Fig. 5
27-105-09	Fig. 6

HARTMANN

27-105-00 Set

bestehend aus: Fig. 1 - Fig. 4 I (4 Stück)
consisting of: Fig. 1 - Fig. 4 I (4 pieces)
compuesto de: Fig. 1 - Fig. 4 I (4 piezas)
composto da: Fig. 1 - Fig. 4 I (4 pezzi)

Fig. 0



3,0 mm

27-106-02

Fig. 1



3,5 mm

27-106-03

Fig. 2



4,5 mm

27-106-04

Fig. 3



5,5 mm

27-106-05

Fig. 4



6,5 mm

27-106-06

Fig. 5



7,6 mm

27-106-07

Fig. 6



9,1 mm

27-106-09

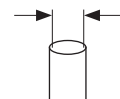

Innendurchmesser
Inside diameter
Diámetro interior
Diámetro interno

BOUCHERON

27-106-02	Fig. 0
27-106-03	Fig. 1
27-106-04	Fig. 2
27-106-05	Fig. 3
27-106-06	Fig. 4
27-106-07	Fig. 5
27-106-09	Fig. 6

BOUCHERON

27-106-00 Set

bestehend aus: Fig. 1 - Fig. 4 I (4 Stück)
consisting of: Fig. 1 - Fig. 4 I (4 pieces)
compuesto de: Fig. 1 - Fig. 4 I (4 piezas)
composto da: Fig. 1 - Fig. 4 I (4 pezzi)

BOUCHERON

27-106-01 Set

bestehend aus: Fig. 2 - Fig. 5 I (4 Stück)
consisting of: Fig. 2 - Fig. 5 I (4 pieces)
compuesto de: Fig. 2 - Fig. 5 I (4 piezas)
composto da: Fig. 2 - Fig. 5 I (4 pezzi)

Fig. 1



3,0 x 4,0 mm

27-107-01

Fig. 2



4,0 x 5,0 mm

27-107-02

Fig. 3



4,5 x 5,5 mm

27-107-03

Fig. 4



5,0 x 6,0 mm

27-107-04

Fig. 5



5,5 x 6,5 mm

27-107-05

Fig. 6



6,0 x 7,0 mm

27-107-06

Fig. 7



6,5 x 7,5 mm

27-107-07

Fig. 8



7,0 x 8,0 mm

27-107-08

Fig. 9



7,5 x 8,5 mm

27-107-09

20°

STEEL
STAINLESS

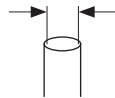

Innendurchmesser
Inside diameter
Diámetro interior
Diámetro interno

FARRIOR

27-107-01	Fig. 1 43 mm
27-107-02	Fig. 2 43 mm
27-107-03	Fig. 3 43 mm
27-107-04	Fig. 4 43 mm
27-107-05	Fig. 5 43 mm
27-107-06	Fig. 6 43 mm
27-107-07	Fig. 7 43 mm
27-107-08	Fig. 8 43 mm
27-107-09	Fig. 9 43 mm

FARRIOR

27-107-10 Set

bestehend aus: Fig. 1 - Fig. 9 | (9 Stück)
consisting of: Fig. 1 - Fig. 9 | (9 pieces)
compuesto de: Fig. 1 - Fig. 9 | (9 piezas)
composto da: Fig. 1 - Fig. 9 | (9 pezzi)

FARRIOR

27-107-00 Set

bestehend aus: Fig. 1,2,5,7,9 | (5 Stück)
consisting of: Fig. 1,2,5,7,9 | (5 pieces)
compuesto de: Fig. 1,2,5,7,9 | (5 piezas)
composto da: Fig. 1,2,5,7,9 | (5 pezzi)

Fig. 1



3,0 x 4,0 mm

27-107-11

Fig. 2



4,0 x 5,0 mm

27-107-12

Fig. 3



4,5 x 5,5 mm

27-107-13

Fig. 4



5,0 x 6,0 mm

27-107-14

Fig. 5



5,5 x 6,5 mm

27-107-15

Fig. 6



6,0 x 7,0 mm

27-107-16

Fig. 7



6,5 x 7,5 mm

27-107-17

Fig. 8



7,0 x 8,0 mm

27-107-18

Fig. 9



7,5 x 8,5 mm

27-107-19

35°

STEEL
STAINLESS

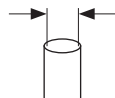

Innendurchmesser
Inside diameter
Diámetro interior
Diámetro interno

FARRIOR

27-107-11	Fig. 1 43 mm
27-107-12	Fig. 2 43 mm
27-107-13	Fig. 3 43 mm
27-107-14	Fig. 4 43 mm
27-107-15	Fig. 5 43 mm
27-107-16	Fig. 6 43 mm
27-107-17	Fig. 7 43 mm
27-107-18	Fig. 8 43 mm
27-107-19	Fig. 9 43 mm

FARRIOR

27-107-20 Set

bestehend aus: Fig. 1 - Fig. 9 | (9 Stück)
consisting of: Fig. 1 - Fig. 9 | (9 pieces)
compuesto de: Fig. 1 - Fig. 9 | (9 piezas)
composto da: Fig. 1 - Fig. 9 | (9 pezzi)

FARRIOR

27-107-21 Set

bestehend aus: Fig. 1,2,5,7,9 | (5 Stück)
consisting of: Fig. 1,2,5,7,9 | (5 pieces)
compuesto de: Fig. 1,2,5,7,9 | (5 piezas)
composto da: Fig. 1,2,5,7,9 | (5 pezzi)

Fig. 0



2,0 mm

27-108-02

Fig. 1



3,0 mm

27-108-03

Fig. 2



4,0 mm

27-108-04

Fig. 3



5,0 mm

27-108-05

Fig. 4



6,0 mm

27-108-06

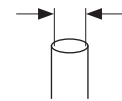

Innendurchmesser
Inside diameter
Diámetro interior
Diámetro interno

TOYNBEE

27-108-02	Fig. 0 33 mm
27-108-03	Fig. 1 36 mm
27-108-04	Fig. 2 36 mm
27-108-05	Fig. 3 36 mm
27-108-06	Fig. 4 35 mm

TOYNBEE

27-108-10	Set
bestehend aus:	Fig. 0 - Fig. 4 (5 Stück)
consisting of:	Fig. 0 - Fig. 4 (5 pieces)
compuesto de:	Fig. 0 - Fig. 4 (5 piezas)
composto da:	Fig. 0 - Fig. 4 (5 pezzi)

TOYNBEE

27-108-00	Set
bestehend aus:	Fig. 1 - Fig. 4 (4 Stück)
consisting of:	Fig. 1 - Fig. 4 (4 pieces)
compuesto de:	Fig. 1 - Fig. 4 (4 piezas)
composto da:	Fig. 1 - Fig. 4 (4 pezzi)

TOYNBEE

27-108-01	Set
bestehend aus:	Fig. 2 - Fig. 4 (3 Stück)
consisting of:	Fig. 2 - Fig. 4 (3 pieces)
compuesto de:	Fig. 2 - Fig. 4 (3 piezas)
composto da:	Fig. 2 - Fig. 4 (3 pezzi)

Fig. 1



2,8 x 3,8 mm

27-109-04

Fig. 2



3,8 x 4,8 mm

27-109-05

Fig. 3



5,0 x 6,2 mm

27-109-06

Fig. 4



6,0 x 7,2 mm

27-109-07

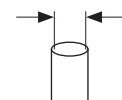

Innendurchmesser
Inside diameter
Diámetro interior
Diámetro interno

GRUBER

27-109-04	Fig. 1 42 mm
27-109-05	Fig. 2 42 mm
27-109-06	Fig. 3 42 mm
27-109-07	Fig. 4 42 mm

GRUBER

27-109-00	Set
bestehend aus:	Fig. 1 - Fig. 4 (4 Stück)
consisting of:	Fig. 1 - Fig. 4 (4 pieces)
compuesto de:	Fig. 1 - Fig. 4 (4 piezas)
composto da:	Fig. 1 - Fig. 4 (4 pezzi)

GRUBER

27-109-01	Set
bestehend aus:	Fig. 2 - Fig. 4 (3 Stück)
consisting of:	Fig. 2 - Fig. 4 (3 pieces)
compuesto de:	Fig. 2 - Fig. 4 (3 piezas)
composto da:	Fig. 2 - Fig. 4 (3 pezzi)

Fig. 0



2,0 mm

27-110-03

Fig. 1



3,0 mm

27-110-04

Fig. 2



4,0 mm

27-110-05

Fig. 3



5,0 mm

27-110-06

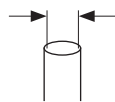

Innendurchmesser
Inside diameter
Diámetro interior
Diámetro interno

Lagerungsgestell für 12 Ohrspekula
Rack for 12 ear speculas
Soporte para 12 espéculos auriculares
Telaio per speculi auricolari

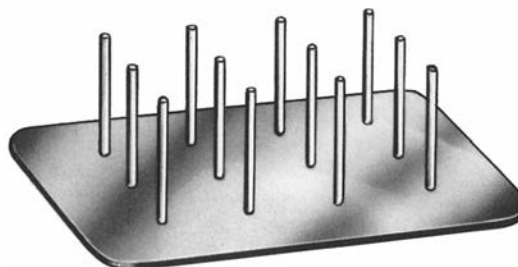

RICHNAU-HOLMGREN

27-110-03	Fig. 0 37 mm
27-110-04	Fig. 1 37 mm
27-110-05	Fig. 2 37 mm
27-110-06	Fig. 3 37 mm

27-110-99



SIEGLE

27-118-00 SET

Fig. 1



5,0 mm

27-118-02

Fig. 2



6,0 mm

27-118-03

Fig. 3



7,0 mm

27-118-04

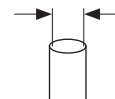

Innendurchmesser
Inside diameter
Diámetro interior
Diámetro interno

Komplett, bestehend aus:

1 Gebläse	27-118-01
1 Ohrspekula, Ø 5,0 mm	27-118-02
1 Ohrspekula, Ø 6,0 mm	27-118-03
1 Ohrspekula, Ø 7,0 mm	27-118-04
1 Lupenkörper	27-118-05

Complete, consisting of:

1 Rubber bulb	27-118-01
1 Ear specula, Ø 5,0 mm	27-118-02
1 Ear specula, Ø 6,0 mm	27-118-03
1 Ear specula, Ø 7,0 mm	27-118-04
1 Diagnostic head	27-118-05

Completo, compuesto de:

1 Pera de goma	27-118-01
1 Espéculo, Ø 5,0 mm	27-118-02
1 Espéculo, Ø 6,0 mm	27-118-03
1 Espéculo, Ø 7,0 mm	27-118-04
1 Cuerpo de lupa	27-118-05

Completo, composto da:

1 Mantico con tubo	27-118-01
1 Speculo, Ø 5,0 mm	27-118-02
1 Speculo, Ø 6,0 mm	27-118-03
1 Speculo, Ø 7,0 mm	27-118-04
1 Portalente pieno	27-118-05



BRUENINGS

27-120-00 SET

Komplett in Etui bestehend aus:	Complete in case, consisting of:
1 Ohrspekula, Ø 3,0 mm	1 Ear specula, Ø 3,0 mm
1 Ohrspekula, Ø 4,0 mm	1 Ear specula, Ø 4,0 mm
1 Ohrspekula, Ø 5,0 mm	1 Ear specula, Ø 5,0 mm
1 Ohrspekula, Ø 6,5 mm	1 Ear specula, Ø 6,5 mm
1 Gebläse mit Schlauch	1 Rubber bulb with tube
1 Lupenkörper, volles Fenster	1 Diagnostic head, full lens

Completo en estuche, compuesto de:	Completo con casetta, composto da:
1 Espéculo auricular, Ø 3,0 mm	1 Speculo auricolare, Ø 3,0 mm
1 Espéculo auricular, Ø 4,0 mm	1 Speculo auricolare, Ø 4,0 mm
1 Espéculo auricular, Ø 5,0 mm	1 Speculo auricolare, Ø 5,0 mm
1 Espéculo auricular, Ø 6,5 mm	1 Speculo auricolare, Ø 6,5 mm
1 Pera de goma con tubo	1 Mantico con tubo in gomma
1 Cuerpo de lupa, lleno	1 Portalente, pieno

BRUENINGS

27-121-00 SET

Komplett in Etui bestehend aus:	Complete in case, consisting of:
1 Ohrspekula, Ø 2,5 mm	1 Ear specula, Ø 2,5 mm
1 Ohrspekula, Ø 3,0 mm	1 Ear specula, Ø 3,0 mm
1 Ohrspekula, Ø 4,0 mm	1 Ear specula, Ø 4,0 mm
1 Ohrspekula, Ø 5,0 mm	1 Ear specula, Ø 5,0 mm
1 Ohrspekula, Ø 6,5 mm	1 Ear specula, Ø 6,5 mm
1 Ohrspekula, Ø 8,5 mm	1 Ear specula, Ø 8,5 mm
1 Gebläse mit Schlauch	1 Rubber bulb with tube
1 Lupenkörper, volles Fenster	1 Diagnostic head, full lens
1 Lupenkörper, Segment Ausschnitt	1 Diagnostic head, segmented lens

Completo en estuche, compuesto de:	Completo con casetta, composto da:
1 Espéculo auricular, Ø 2,5 mm	1 Speculo auricolare, Ø 2,5 mm
1 Espéculo auricular, Ø 3,0 mm	1 Speculo auricolare, Ø 3,0 mm
1 Espéculo auricular, Ø 4,0 mm	1 Speculo auricolare, Ø 4,0 mm
1 Espéculo auricular, Ø 5,0 mm	1 Speculo auricolare, Ø 5,0 mm
1 Espéculo auricular, Ø 6,5 mm	1 Speculo auricolare, Ø 6,5 mm
1 Espéculo auricular, Ø 8,5 mm	1 Speculo auricolare, Ø 8,5 mm
1 Pera de goma con tubo	1 Mantico con tubo in gomma
1 Cuerpo de lupa, lleno	1 Portalente, pieno
1 Cuerpo de lupa, cortadura segmento	1 Portalente, parte de segmento

Fig. 1



2,5 mm

Fig. 2



3,0 mm

Fig. 3



4,0 mm

Fig. 4



5,0 mm

Fig. 5



6,5 mm

Fig. 6



8,5 mm

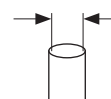

Innendurchmesser
Inside diameter
Diámetro interior
Diámetro interno



stumpf, gerade
blunt, straight
roma, recta
smussa, retta



stumpf, abgewinkelt
blunt, angled
roma, acodado
smussa, angolati



scharf, gerade
sharp, straight
agudo, recta
acuto, retta



27-150-01	1,5mm Fig. 000
27-150-02	2,0mm Fig. 00
27-150-03	2,5mm Fig. 0
27-150-04	3,0mm Fig. 1
27-150-05	3,5mm Fig. 2
27-150-06	4,0mm Fig. 3
27-150-07	4,5mm Fig. 4
27-150-08	5,0mm Fig. 5

27-151-01	1,5mm Fig. 000
27-151-02	2,0mm Fig. 00
27-151-03	2,5mm Fig. 0
27-151-04	3,0mm Fig. 1
27-151-05	3,5mm Fig. 2
27-151-06	4,0mm Fig. 3
27-151-07	4,5mm Fig. 4
27-151-08	5,0mm Fig. 5

27-152-01	1,5mm Fig. 000
27-152-02	2,0mm Fig. 00
27-152-03	2,5mm Fig. 0
27-152-04	3,0mm Fig. 1
27-152-05	3,5mm Fig. 2
27-152-06	4,0mm Fig. 3
27-152-07	4,5mm Fig. 4
27-152-08	5,0mm Fig. 5

Ohrküretten
Ear cures
Curetas auriculares
Curette auricolari

scharf, abgewinkelt
sharp, angled
agudo, acodado
acuto, angolati



27-153-01	1,5mm Fig. 000
27-153-02	2,0mm Fig. 00
27-153-03	2,5mm Fig. 0
27-153-04	3,0mm Fig. 1
27-153-05	3,5mm Fig. 2
27-153-06	4,0mm Fig. 3
27-153-07	4,5mm Fig. 4
27-153-08	5,0mm Fig. 5

BUCK

27-150-01 - 27-153-08 17,0 cm, 6 3/4"



27-155-13

stumpf
blunt
romo
smusso



Ohrschlinge
Ear loop
Asas auriculares
Anse auricolari

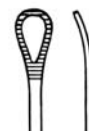

27-155-16



27-155-17



Ohrschlingen
Ear loops
Asas auriculares
Anse auricolari

LANGENBECK

27-155-13 13,0 cm, 5 1/8"

SNELLEN

27-155-16 - 27-155-17 16,0 cm, 6 1/4"

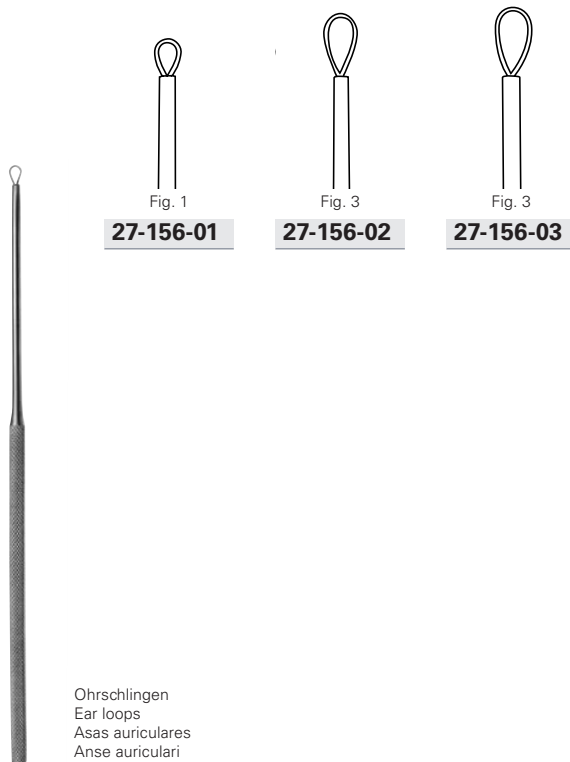

Ohrschlingen
 Ear loops
 Asas auriculares
 Anse auricolari

Ohrküretten
 Ear cures
 Curetas auriculares
 Curette auricolari

BILLEAU

27-156-01 - 27-156-03 16,0 cm, 6 ¼"

WEISMAN

27-157-02 - 27-157-03 14,0 cm, 5 ½"

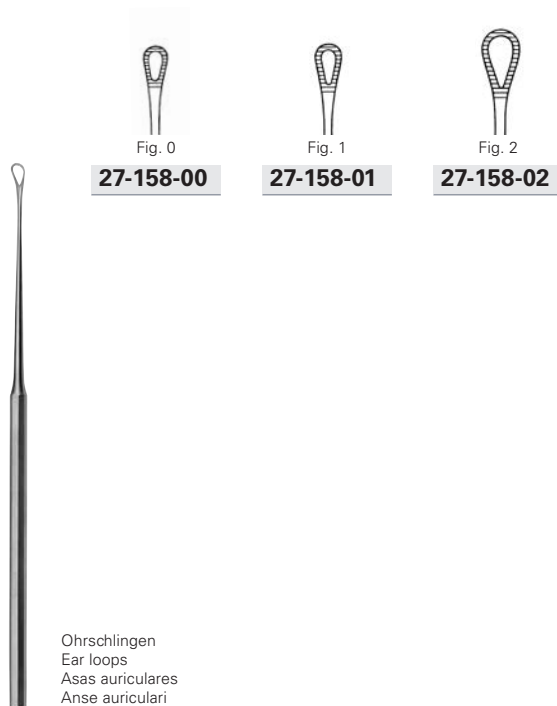

Ohrschlingen
 Ear loops
 Asas auriculares
 Anse auricolari

Ohrschlingen
 Ear loops
 Asas auriculares
 Anse auricolari

WEBER-LOCH

27-158-00 - 27-158-02 14,5 cm, 5 ¾"

SHAPLEIGH

27-160-01 - 27-160-04 13,0 cm, 5 ⅛"

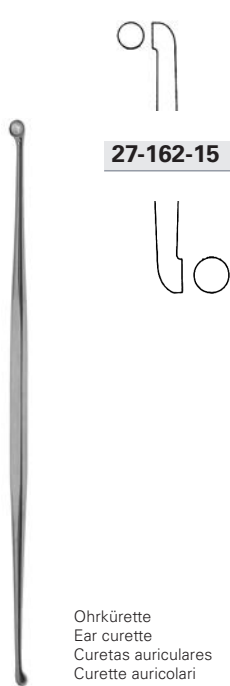

JANSEN

27-162-15 15,0 cm, 6 "



BARTH

27-164-18 18,0 cm, 7 "

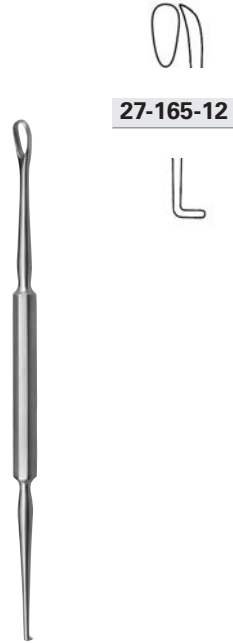

GROSS

27-165-12 13,0 cm, 5 "



WEBER-LOCH

27-166-16 16,5 cm, 6 ½ "

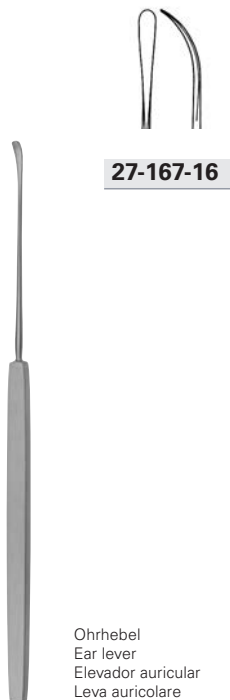

ZAUFAL

27-167-16 15,0 cm, 6 "

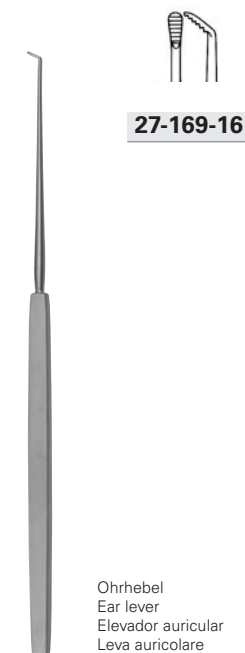

MOLDENHAUER

27-169-16 16,0 cm, 6 ¼ "



FORMBY

27-170-17 18,0 cm, 7 "



MUSGROVE

27-172-18 18,0 cm, 7 "

Zerumenlöffel und Häkchen
Cerumen scoop and hook
Cucharilla de cerumen y ganchitos
Cucchiaio per cerume e gancio

Zerumennadel und Watteträger
Cerumen pick and wool carrier
Aguja de cerumen y aplicadores de algodón
Ago per cerume e portagarze



27-173-15

Ohrhäkcken
 Ear hook
 Gnachitos auriculares
 Uncini auricolari

ZAUFAL-JANSEN

27-173-15 15,0 cm, 6 "



27-175-16

scharf
 sharp
 agudo
 acuto

Ohrhäkcken
 Ear hook
 Gnachitos auriculares
 Uncini auricolari

HARTMANN

27-175-16 16,0 cm, 6 ¼ "



Fig. 1

27-181-01

Ohrhäkcken
 Ear hook
 Gnachitos auriculares
 Uncini auricolari

DAY

27-181-01 - 27-181-02 17,0 cm, 6 ¾ "

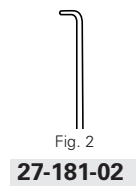
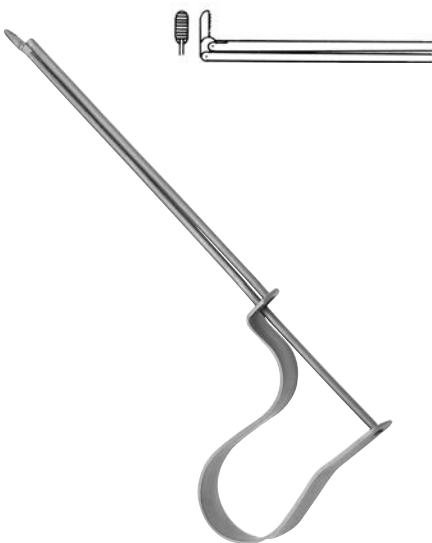

Fig. 2

27-181-02

Fremdkörperheber
 Foreign body lever
 Elevador para cuerpos extraños
 Leva per corpi estranei



QUIRE

27-200-09 10,5 cm, 4 ¼ "

Fremdkörperzängchen
 Foreign body forceps
 Pinza para cuerpos extraños
 Pinze per corpi estranei

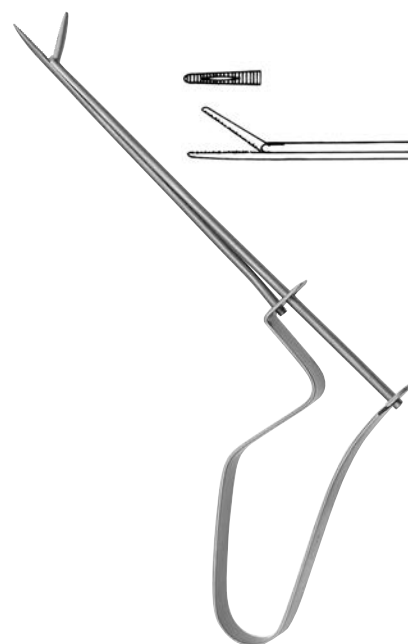

BUCK

27-202-09 11,5 cm, 4 ¼ "



27-204-12



LITTAUER

27-204-12 12,0 cm, 4 3/4"



27-206-12



HARTMANN

27-206-12 12,0 cm, 4 3/4"



27-208-14



HARTMANN

27-208-14 14,0 cm, 5 1/2"



HARTMANN

27-209-14 8,5 cm, 3 1/3"

Faßzängchen, schnabelförmiges Maul
Grasping forceps, duckbill jaw
Pinza de agarre, en forma de pico
Pinte da presa, a forma di becco d'oca



0,8 x 6,0 mm

HARTMANN-WULLSTEIN

27-210-07 8,5 cm, 3 1/3"

Faßzängchen
Grasping forceps
Pinza de agarre
Pinte da presa



1,8 x 8,0 mm

HARTMANN-WULLSTEIN

27-210-08 8,5 cm, 3 1/3"

Faßzängchen
Grasping forceps
Pinza de agarre
Pinte da presa



HARTMANN

27-214-08 8,5 cm, 3 1/3"

27-214-14 14,0 cm, 5 1/2"

27-214-16 16,5 cm, 6 1/2"

Faßzängchen
Grasping forceps
Pinza de agarre
Pinte da presa



HARTMANN

27-215-01 15,0 cm, 6"

Faßzängchen, fein, gerieft
Grasping forceps, delicate, serrated
Pinza de agarre, fino, estriado
Pinte da presa, delicato, rigato



HARTMANN

27-215-02 15,0 cm, 6"

Faßzängchen, grob, gerieft
Grasping forceps, rough, serrated
Pinza de agarre, ápero, estriado
Pinte da presa, colossale, rigato

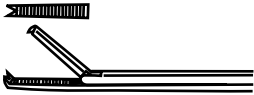
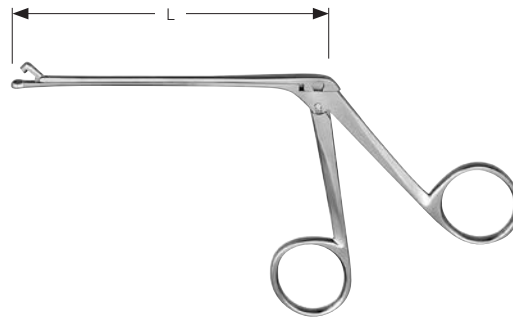

HARTMANN

27-216-08 8,5 cm, 3 1/3 "
27-216-14 14,0 cm, 5 1/2 "

Faßzängchen, 1 x 2 Zähne
Grasping forceps, 1 x 2 teeth
Pinza de agarre, 1 x 2 dientes
Pinte da presa, 1 x 2 denti

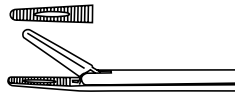

HARTMANN-NOYES

27-218-09 8,5 cm, 3 1/3 "

Faßzängchen
Grasping forceps
Pinza de agarre
Pinte da presa

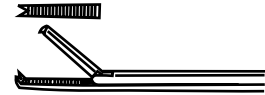

HARTMANN-NOYES

27-220-09 8,5 cm, 3 1/3 "

Faßzängchen, 1 x 2 Zähne
Grasping forceps, 1 x 2 teeth
Pinza de agarre, 1 x 2 dientes
Pinte da presa, 1 x 2 denti

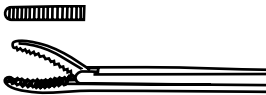

HARTMANN-WEINGAERTNER

27-222-08 8,5 cm, 3 1/3 "

Faßzängchen
Grasping forceps
Pinza de agarre
Pinte da presa



HARTMANN

27-224-08 8,5 cm, 3 1/3 "

Löffelzängchen, oval
Spoon forceps, oval
Pinza de copas, oval
Pinza a cucchiaio, ovale



HARTMANN

27-224-18 18,0 cm, 7 "

Löffelzängchen, oval
Spoon forceps, oval
Pinza de copas, oval
Pinza a cucchiaio, ovale



HARTMANN



27-224-18 B 18,0 cm, 7 "

Löffelzängchen, oval
Spoon forceps, oval
Pinza de copas, oval
Pinza a cucchiaio, ovale

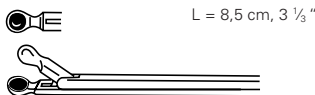

HARTMANN

27-226-01 Ø 2,0 mm
27-226-02 Ø 2,5 mm
27-226-03 Ø 3,0 mm

Löffelzängchen
Spoon forceps
Pinza de copas
Pinza a cucchiaio



HARTMANN

27-226-11 Ø 2,0 mm

Löffelzängchen
Spoon forceps
Pinza de copas
Pinza a cucchiaio

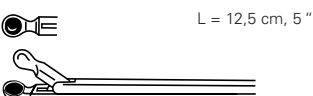

HARTMANN

27-226-12 Ø 2,5 mm

Löffelzängchen
Spoon forceps
Pinza de copas
Pinza a cucchiaio



HARTMANN-HOFFMANN

27-226-20 Ø 2,0 mm

Löffelzängchen, durchschneidend
Spoon forceps, through cutting
Pinza de copas, cortante
Pinza a cucchiaio, tagliente

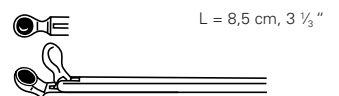

HARTMANN

27-228-07 Ø 2,0 mm
27-228-08 Ø 3,0 mm

Löffelzängchen, 45°
Spoon forceps, 45°
Pinza de copas, 45°
Pinza a cucchiaio, 45°

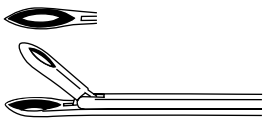
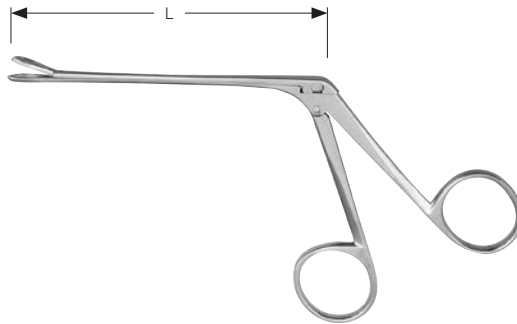

STRUEMPEL

27-230-08 8,5 cm, 3 1/3 "
27-230-18 12,5 cm, 5 "

Löffelzängchen, oval
Spoon forceps, oval
Pinza de copas, oval
Pinza a cucchiaio, ovale



STRUEMPEL

27-230-19 12,5 cm, 5 "

Löffelzängchen, oval, 45°
Spoon forceps, oval, 45°
Pinza de copas, oval, 45°
Pinza a cucchiaio, ovale, 45°



STRUEMPEL

27-230-20 12,5 cm, 5 "

Löffelzängchen, oval, 90°
Spoon forceps, oval, 90°
Pinza de copas, oval, 90°
Pinza a cucchiaio, ovale, 90°

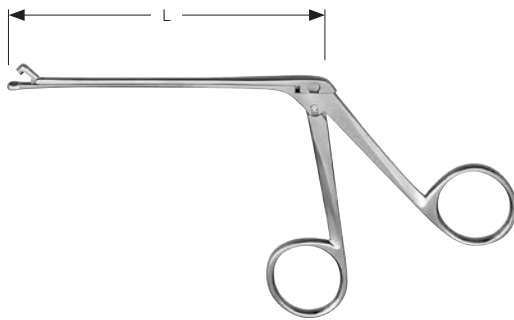

27-231-12 12,5 cm, 5 "

Faßzängchen, 45°
Grasping forceps, 45°
Pinza de agarre, 45°
Pinte da presa, 45°



MASING

27-234-15 8,5 cm, 3 1/3 "

Nadelhalter
Needle holder
Porta aguja
Portaghi

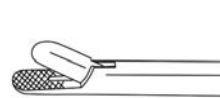
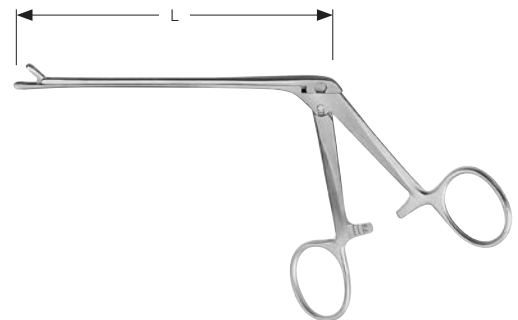

27-236-15 8,5 cm, 3 1/3 "

Nadelhalter
Needle holder
Porta aguja
Portaghi



27-300-15



Periostmesser
 Periosteal knife
 Cuchillo para periostio
 Coltello periostio

MUCK

27-300-15 15,0 cm, 6 "



27-301-15



Myringotom
 Myringotome
 Miringotomo
 Miringotomo

BUCK

27-301-15 15,0 cm, 6 "



27-303-16



Furunkelmesser
 Furuncle knife
 Cuchillo para furúnculo
 Bisturi per foruncoli

POLITZER

27-303-16 16,0 cm, 6 ¼ "



27-304-18



Parazentesenadel
 Tympanum perforator
 Aguja para paracentesis
 Ago per paracentesi

SEXTON

27-304-18 18,0 cm, 7 "



27-305-17



Parazentesenadel
 Tympanum perforator
 Aguja para paracentesis
 Ago per paracentesi

SEXTON

27-305-17 17,0 cm, 6 ¾ "



27-306-17



Parazentesenadel
 Tympanum perforator
 Aguja para paracentesis
 Ago per paracentesi

GERZOG-SEXTON

27-306-17 17,0 cm, 6 ¾ "





27-308-16

Parazentesenadel
Tympanum perforator
Aguja para paracentesis
Ago per paracentesi

POLITZER

27-308-16 16,5 cm, 6 1/2 "



27-309-16

Parazentesenadel
Tympanum perforator
Aguja para paracentesis
Ago per paracentesi

POLITZER

27-309-16 16,5 cm, 6 1/2 "



27-310-99

Ersatznadel
Spare needle
Aguja de repuesto
Ago di ricambio

Parazentesenadel
Tympanum perforator
Aguja para paracentesis
Ago per paracentesi

POLITZER

27-310-17 17,0 cm, 6 3/4 "



27-311-16

Nadel quergestellt
Needle diagonally
Aguja en posición horizontal
Ago orizzontale

Parazentesenadel
Tympanum perforator
Aguja para paracentesis
Ago per paracentesi

POLITZER

27-311-16 16,5 cm, 6 1/2 "



27-311-17

Nadel quergestellt
Needle diagonally
Aguja en posición horizontal
Ago orizzontale

Parazentesenadel
Tympanum perforator
Aguja para paracentesis
Ago per paracentesi

POLITZER

27-311-17 16,5 cm, 6 1/2 "



27-312-17

Parazentesenadel
Tympanum perforator
Aguja para paracentesis
Ago per paracentesi

AGNEW

27-312-17 17,5 cm, 7 "

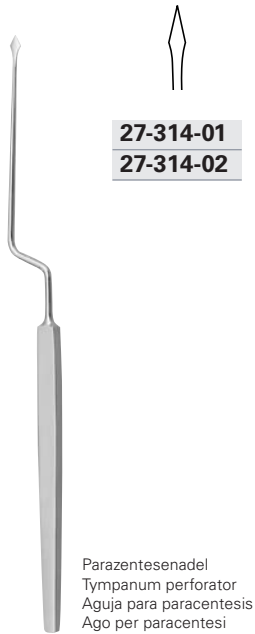

27-314-01
27-314-02

Parazentesadel
 Tympanum perforator
 Aguja para paracentesis
 Ago per paracentesi

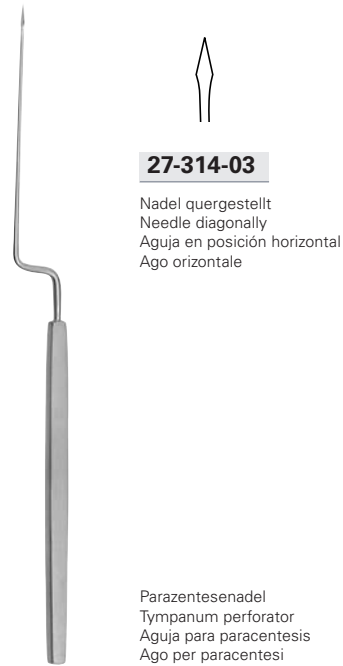

27-314-03

Nadel quergestellt
 Needle diagonally
 Aguja en posición horizontal
 Ago orizzontale

Parazentesadel
 Tympanum perforator
 Aguja para paracentesis
 Ago per paracentesi

LUCAE

27-314-01	16,0 cm, 6 ¼ "
27-314-02	18,0 cm, 7 "

LUCAE

27-314-03	17,5 cm, 7 "
------------------	--------------

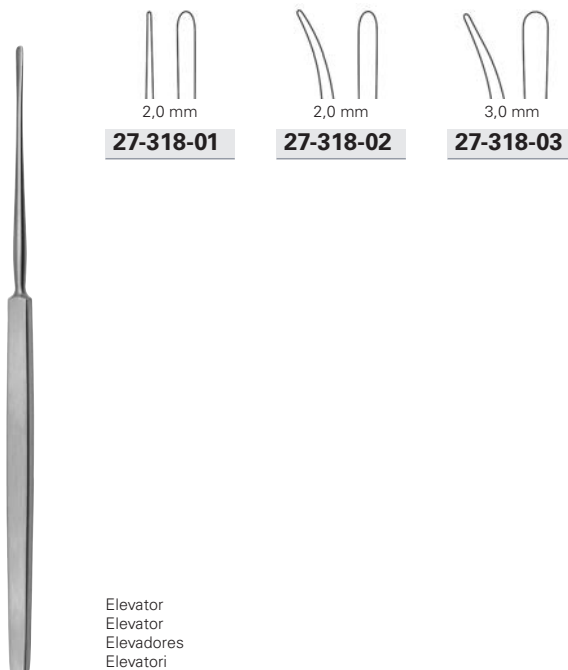

27-318-01

27-318-02

27-318-03

Elevator
 Elevator
 Elevadores
 Elevatori



27-320-18

Elevator
 Elevator
 Elevadores
 Elevatori



27-320-20

Elevator
 Elevator
 Elevadores
 Elevatori

LEMPERT

27-318-01 - 27-318-03	16,5 cm, 6 ½ "
------------------------------	----------------

LEMPERT

27-320-18	18,0 cm, 7 "
------------------	--------------

LEMPERT

27-320-20	20,5 cm, 8 "
------------------	--------------



KRAUSE

27-351-16 18,0 cm, 7 "



KRAUSE-VOSS

27-353-16 18,0 cm, 7 "



LANGE-WILDE

27-355-16 16,0 cm, 6 ¼ "



Verpackungseinheit: 12 St.
Packing unit: 12 pieces
Unidad: 12 piezas
Confezione: 12 pezzi



Verpackungseinheit: 100 St.
Packing unit: 100 pieces
Unidad: 100 piezas
Confezione: 100 pezzi

Schnürdrähte, Rolle mit 10 m
Snare wires, coil of 10 m
Alambre para amigdalótomo, rollo de 10 m
Filo per serranodi, rotolo da 10 m



27-358-30 Ø 0,3 mm
27-358-40 Ø 0,4 mm

Schnürdrähte
Snare wires
Alambre para amigdalótomo
Filo per serranodi



27-359-12 Ø 0,2 mm

Schnürdrähte
Snare wires
Alambre para amigdalótomo
Filo per serranodi



27-359-99 Ø 0,2 mm

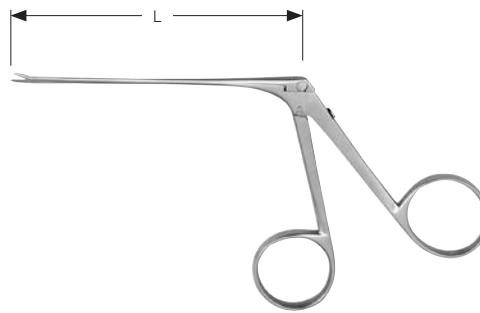

	L = 8,0 cm, 3 1/8"		L = 8,0 cm, 3 1/8"		L = 12,5 cm, 5"		L = 8,0 cm, 3 1/8"
27-400-01	4,0 x 0,8 mm	27-400-02	4,0 x 0,8 mm	27-400-12	4,0 x 0,8 mm	27-400-03	4,0 x 0,8 mm
27-402-01	4,0 x 0,6 mm	27-402-02	4,0 x 0,6 mm	27-402-12	4,0 x 0,6 mm	27-402-03	4,0 x 0,6 mm
27-404-01	3,5 x 0,6 mm	27-404-02	3,5 x 0,6 mm				
glatt, gerade smooth, straight lisa, recta liscia, retta		gerieft, gerade serrated, straight estriada, recta con scanalatura, retta		gerieft, gerade serrated, straight estriada, recta con scanalatura, retta		gerieft, aufgebogen serrated, curved upwards estriada, curva por arriba con scanalatura, curva in alto	
	L = 8,0 cm, 3 1/8"		L = 8,0 cm, 3 1/8"		L = 8,0 cm, 3 1/8"		
27-400-04	4,0 x 0,8 mm	27-400-05	4,0 x 0,8 mm	27-400-06	4,0 x 0,8 mm		
27-402-04	4,0 x 0,6 mm	27-402-05	4,0 x 0,6 mm	27-402-06	4,0 x 0,6 mm		
gerieft, rechts serrated, right estriada, derecha con scanalatura, destra		gerieft, links serrated, left estriada, izquierda con scanalatura, sinistra		gerieft, abgebogen serrated, curved downwards estriada, curva por abajo con scanalatura, curva in basso			

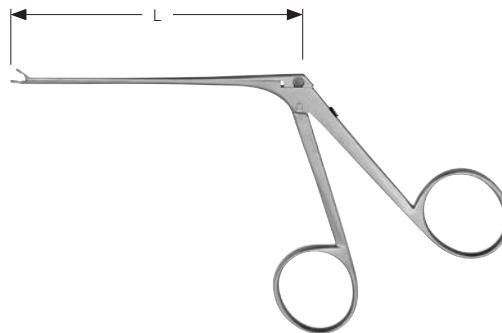

WULLSTEIN

	L = 12,5 cm, 5"		L = 8,0 cm, 3 1/8"		L = 8,0 cm, 3 1/8"
27-406-00	Ø 1,0 mm	27-405-01	1,5 x 0,8 mm	27-405-02	1,5 x 0,8 mm
gerade, rund straight, round recta, redondo retta, rotondo		27-406-01	1,0 x 0,9 mm	27-406-02	1,0 x 0,9 mm
		27-408-01	0,6 x 0,5 mm	27-408-02	0,6 x 0,5 mm
		gerade, oval straight, oval recta, oval retta, ovale		aufgebogen, oval curved upwards, oval curba por arriba, oval curva in alto, ovale	
	L = 8,0 cm, 3 1/8"		L = 8,0 cm, 3 1/8"		L = 8,0 cm, 3 1/8"
27-405-03	1,5 x 0,8 mm	27-405-04	1,5 x 0,8 mm	27-405-05	1,5 x 0,8 mm
27-406-03	1,0 x 0,9 mm	27-406-04	1,0 x 0,9 mm	27-406-05	1,0 x 0,9 mm
27-408-03	0,6 x 0,5 mm	27-408-04	0,6 x 0,5 mm	27-408-05	0,6 x 0,5 mm
rechts, oval right, oval derecha, oval destra, ovale		links, oval left, oval izquierda, oval sinistra, ovale		abgebogen, oval curved downwards, oval curba por abajo, oval curva in basso, ovale	

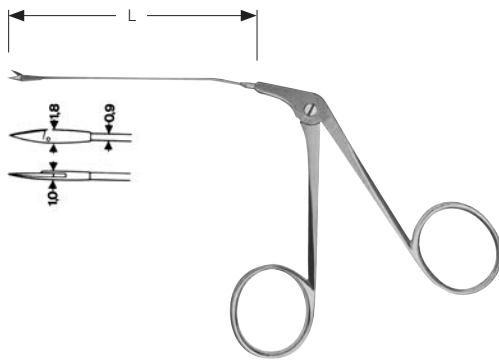

 L = 8,0 cm, 3 1/8"

27-409-01 1,0 x 1,8 mm

rechts
right
derecha
destra

mit Rohrschaft
with tubular shaft
con vástago tubular
con asta tubolare

 L = 8,0 cm, 3 1/8"

27-409-02 1,0 x 1,8 mm

links
left
izquierda
sinistra

mit Rohrschaft
with tubular shaft
con vástago tubular
con asta tubolare

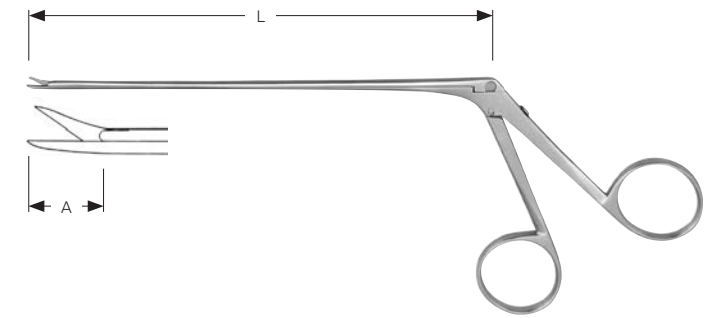

 L = 12,5 cm, 5"

BELLUCCI

27-412-11 A = 4,5 mm

gerade
straight
recta
retta

 L = 15,0 cm, 6"

BELLUCCI

27-412-15 A = 4,5 mm

gerade
straight
recta
retta

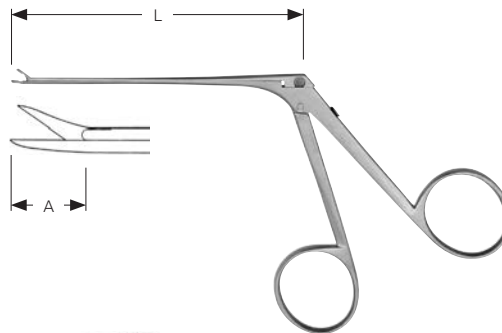

 L = 8,0 cm, 3 1/8"

BELLUCCI

 L = 8,0 cm, 3 1/8"

27-410-01 A = 8,0 mm

27-412-01 A = 4,5 mm

27-414-01 A = 3,5 mm

gerade
straight
recta
retta

27-410-02 A = 6,0 mm

27-412-02 A = 4,0 mm

aufgebogen
curved upwards
curva por arriba
curva in alto

 L = 8,0 cm, 3 1/8"

27-410-03 A = 8,0 mm

27-412-03 A = 4,5 mm

27-414-03 A = 3,5 mm

rechts
right
derecha
destra

 L = 8,0 cm, 3 1/8"

27-410-04 A = 8,0 mm

27-412-04 A = 4,5 mm

27-414-04 A = 3,5 mm

links
left
izquierda
sinistra

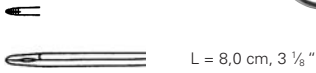
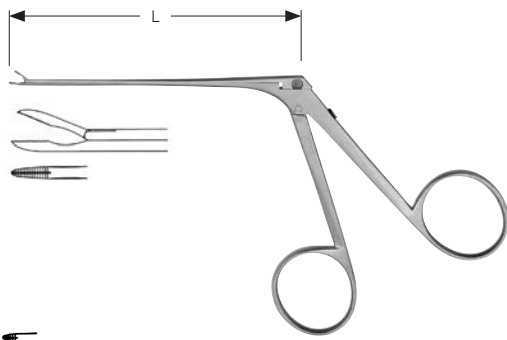

GREVEN

27-420-01 0,8 x 5,0 mm

gerade
 straight
 recta
 retta

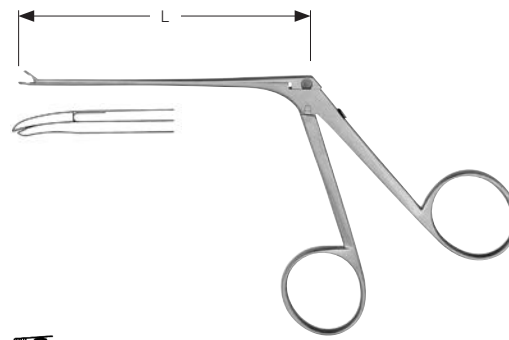

SCHUKNECHT

27-420-02 0,8 x 6,0 mm

abgebogen
 curved downwards
 curba por abajo
 curva in basso

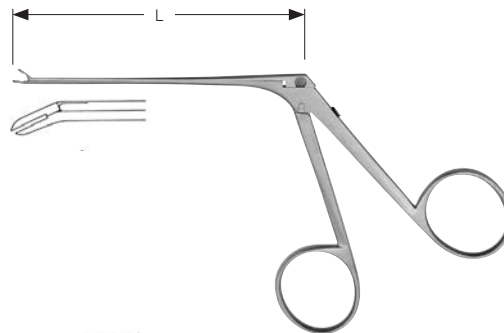

MC GEE



27-422-01 0,8 x 3,5 mm

abgebogen
 curved downwards
 curba por abajo
 curva in basso



27-422-02 0,8 x 5,5 mm

abgebogen
 curved downwards
 curba por abajo
 curva in basso



27-422-03 0,8 x 3,5 mm

rechts
 right
 derecha
 destra



27-422-04 0,8 x 3,5 mm

links
 left
 izquierda
 sinistra

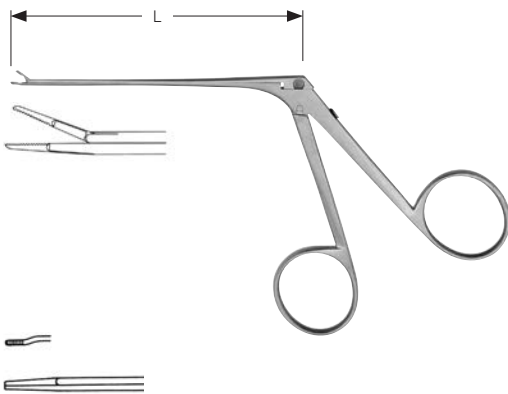

JUERS

27-424-01 8,0 cm, 3 1/8"

Drahtbiegezängchen, links
Wire bending forceps, left
Pinza para plegar alambre, izquierda
Pinza per piegare fili metallici, sinistra

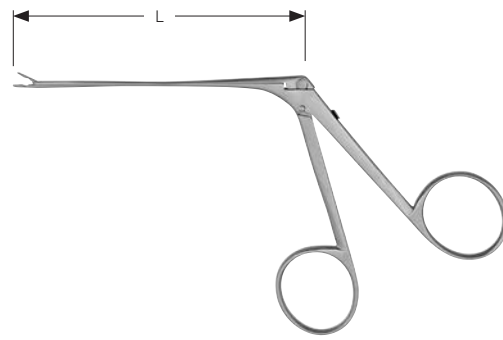

FULLER

27-428-01 8,0 cm, 3 1/8"

Einführungszängchen für Teflonprothesen
Introducing forceps for teflon prothesis
Pinza para introducir para prótesis de teflon
Pinza per introduzione per protesi in teflon

JUERS

27-424-02 8,0 cm, 3 1/8"

Drahtbiegezängchen, rechts
Wire bending forceps, right
Pinza para plegar alambre, derecha
Pinza per piegare fili metallici, destra

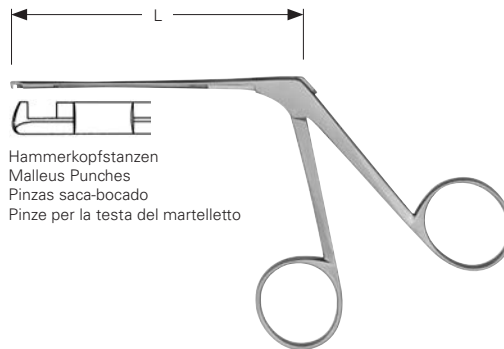

Hammerkopfstanzan
Malleus Punches
Pinzas saca-bocado
Pinze per la testa del martelletto

HOUSE-DIETER

 L = 8,0 cm, 3 1/8"

27-426-01 1,3 mm

unten schneidend
down-cutting
corte abajo
tagliente in basso

 L = 8,0 cm, 3 1/8"

27-426-02 1,3 mm

oben schneidend
up-cutting
corte arriba
tagliente in alto

 L = 8,0 cm, 3 1/8"

27-426-03 1,3 mm

links schneidend
left cutting
corte izquierda
tagliente a sinistra

 L = 8,0 cm, 3 1/8"

27-426-04 1,3 mm

rechts scheidend
right cutting
corte derecha
tagliente a destra

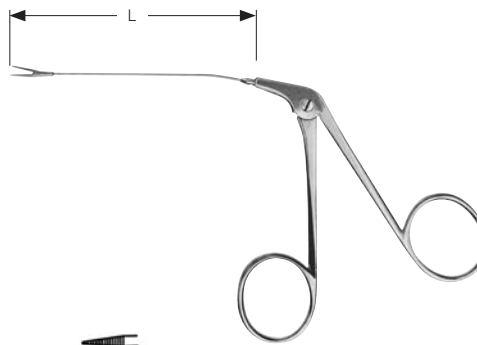

L = 8,0 cm, 3 1/8"

- 27-450-01** 3,5 x 0,8 mm
- 27-450-02** 5,0 x 1,0 mm
- 27-450-03** 6,0 x 1,5 mm

gerade
straight
recta
retta

mit Rohrschaft
with tubular shaft
con vástago tubular
con asta tubolare

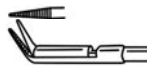

L = 8,0 cm, 3 1/8"

- 27-450-04** 3,5 x 0,8 mm

aufgebogen
curved upwards
curva por arriba
curva in alto

mit Rohrschaft
with tubular shaft
con vástago tubular
con asta tubolare

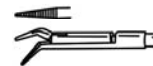

L = 8,0 cm, 3 1/8"

- 27-450-05** 3,5 x 0,8 mm

abgebogen
curved downwards
curva por abajo
curva in basso

mit Rohrschaft
with tubular shaft
con vástago tubular
con asta tubolare

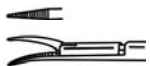

L = 8,0 cm, 3 1/8"

- 27-450-06** 5,0 x 1,0 mm

links
left
izquierda
sinistra

mit Rohrschaft
with tubular shaft
con vástago tubular
con asta tubolare

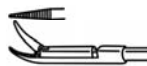

L = 8,0 cm, 3 1/8"

- 27-450-07** 5,0 x 1,0 mm

links
left
izquierda
sinistra

mit Rohrschaft
with tubular shaft
con vástago tubular
con asta tubolare

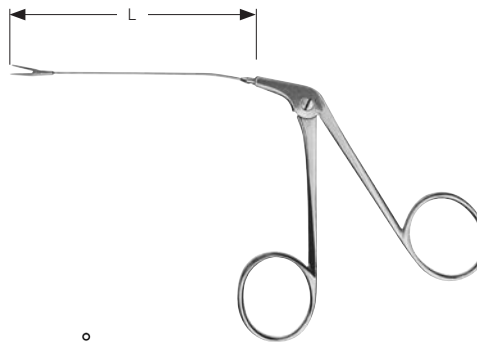

L = 8,0 cm, 3 1/8"

- 27-452-01** 0,9 x 1,0 mm
- 27-452-02** 0,8 x 1,3 mm
- 27-452-04** 1,7 x 2,5 mm

gerade, oval
straight, oval
recta, oval
retta, ovale

mit Rohrschaft
with tubular shaft
con vástago tubular
con asta tubolare



L = 8,0 cm, 3 1/8"

- 27-452-03** Ø 1,0 mm

gerade, rund
straight, round
recta, redondo
retta, rotondo

mit Rohrschaft
with tubular shaft
con vástago tubular
con asta tubolare



L = 8,0 cm, 3 1/8"

- 27-452-05** 0,9 x 1,0 mm

aufgebogen, oval
curved upwards, oval
curva por arriba, oval
curva in alto, ovale

mit Rohrschaft
with tubular shaft
con vástago tubular
con asta tubolare



L = 8,0 cm, 3 1/8"

- 27-452-06** 0,8 x 1,3 mm

links, oval
left, oval
izquierda, oval
sinistra, ovale

mit Rohrschaft
with tubular shaft
con vástago tubular
con asta tubolare



L = 8,0 cm, 3 1/8"

- 27-452-07** 0,8 x 1,3 mm

rechts, oval
right, oval
derecha, oval
destra, ovale

mit Rohrschaft
with tubular shaft
con vástago tubular
con asta tubolare

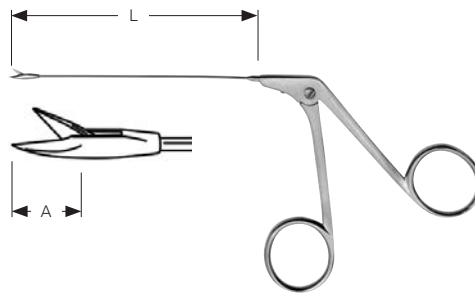

BELLUCCI



27-454-01 A = 4,0 mm

gerade
straight
recta
retta
mit Rohrschaft
with tubular shaft
con vástago tubular
con asta tubolare



27-454-02 A = 4,0 mm

aufgebogen
bent upwards
curva por arriba
curva in alto
mit Rohrschaft
with tubular shaft
con vástago tubular
con asta tubolare

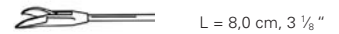

27-454-03 A = 4,0 mm

links gebogen
curved left
curva a la izquierda
curve verso sinistra
mit Rohrschaft
with tubular shaft
con vástago tubular
con asta tubolare



27-454-04 A = 4,0 mm

rechts gebogen
curved right
curva a la derecha
curve verso destra
mit Rohrschaft
with tubular shaft
con vástago tubular
con asta tubolare



27-454-05 A = 4,0 mm

horizontal schneidend
horizontal cutting
corte horizontal
a taglio orizzontale
mit Rohrschaft
with tubular shaft
con vástago tubular
con asta tubolare

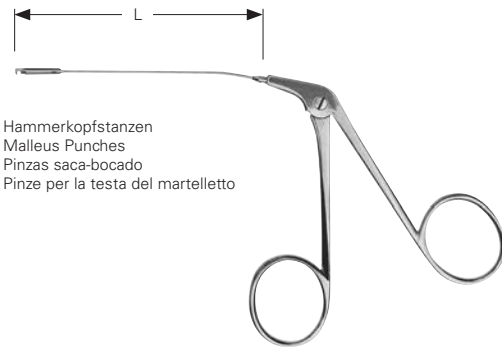

Hammerkopfstanzen
Malleus Punches
Pinzas saca-bocado
Pinza per la testa del martelletto



DIETER

27-454-06 1,3 mm

oben schneidend
up-cutting
corte arriba
tagliente in alto
mit Rohrschaft
with tubular shaft
con vástago tubular
con asta tubolare

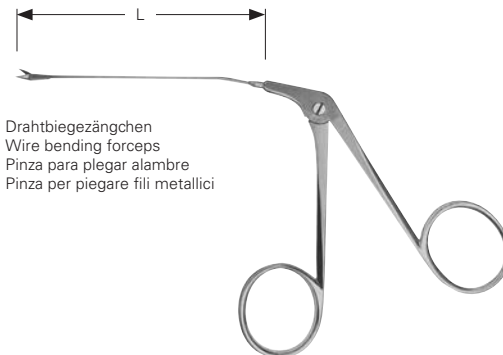

Drahtbiegezängchen
Wire bending forceps
Pinza para plegar alambre
Pinza per piegare fili metallici

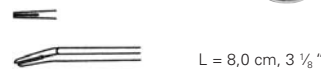

MC GEE

27-454-08 0,8 x 3,5 mm

abgebogen
curved downwards
curva por abajo
curva in basso
mit Rohrschaft
with tubular shaft
con vástago tubular
con asta tubolare



DIETER

27-454-07 1,3 mm

unten schneidend
down-cutting
corte abajo
tagliente in basso
mit Rohrschaft
with tubular shaft
con vástago tubular
con asta tubolare



MC GEE

27-454-09 0,8 x 5,5 mm

abgebogen
curved downwards
curva por abajo
curva in basso
mit Rohrschaft
with tubular shaft
con vástago tubular
con asta tubolare

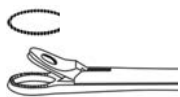
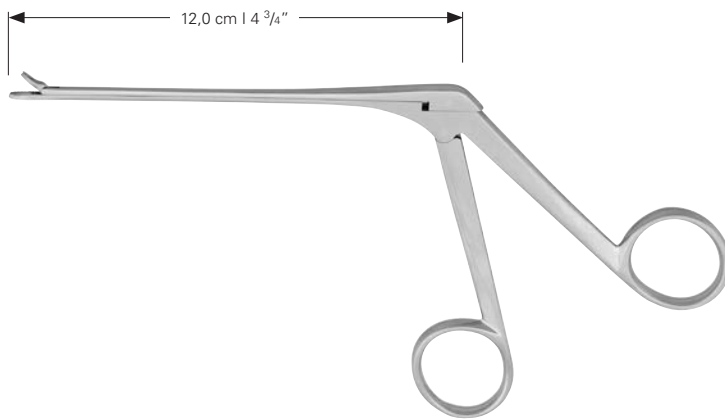

WEIL-BLAKESLEY

27-460-25	2,5 mm
27-460-36	3,6 mm
27-460-48	4,8 mm

gerade, durchschneidend
 straight, through cutting
 recta, cortantes
 retta, taglianti

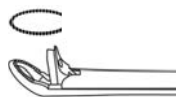

WEIL-BLAKESLEY

27-461-25	2,5 mm
27-461-36	3,6 mm
27-461-48	4,8 mm

aufgebogen 45°, durchschneidend
 curved up 45°, through cutting
 curva por arriba 45°, cortantes
 curva in alto 45°, taglianti



27-500-01

Diszisionsmesser
 Discision knife
 Cuchillo de discision
 Bisturi da discissione



PLESTER

27-500-02

Sichelmesser
 Sickle knife
 Cuchillo en forma de hoz
 Bisturi falciforme



TABB

27-500-04

Schleimhautmesser
 Mucosa knife
 Cuchillo para mucosa
 Bisturi per mucosa



BEALES

27-500-05

Sehnenmesser
 Tendon knife
 Cuchillo para el tendón
 Bisturi per tendine



27-500-06

Sichelmesser
 Sickle knife
 Cuchillo en forma de hoz
 Bisturi falciforme



PLESTER

27-500-12

Sichelmesser
 Sickle knife
 Cuchillo en forma de hoz
 Bisturi falciforme



PLESTER

27-500-13

Sichelmesser
 Sickle knife
 Cuchillo en forma de hoz
 Bisturi falciforme



PLESTER

27-500-15

Sichelmesser
 Sickle knife
 Cuchillo en forma de hoz
 Bisturi falciforme



2,4 x 3,0 mm

PLESTER

27-501-01

Lappenmesser
 Flap knife
 Cuchillo para lóbulos
 Bisturi a falda



2,4 x 3,5 mm

PLESTER

27-501-02

Lappenmesser
 Flap knife
 Cuchillo para lóbulos
 Bisturi a falda

27-500-01 - 27-502-02 16,0 cm, 6 1/4"

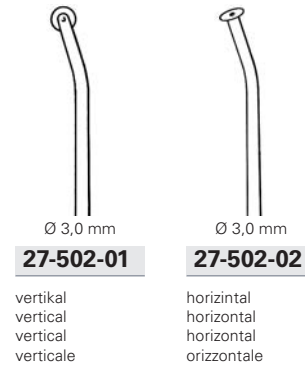
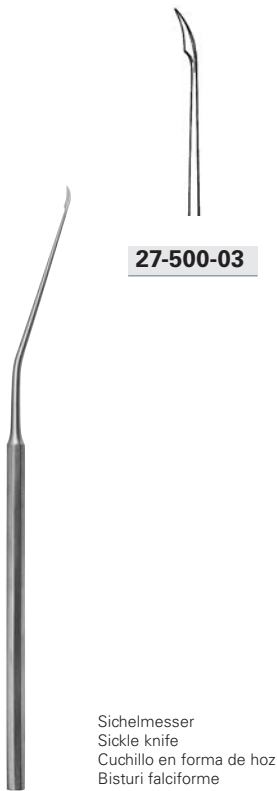

SCHUKNECHT

27-500-03 16,0 cm, 6 1/4"

SCHUKNECHT

27-502-01 - 27-502-02 16,0 cm, 6 1/4"

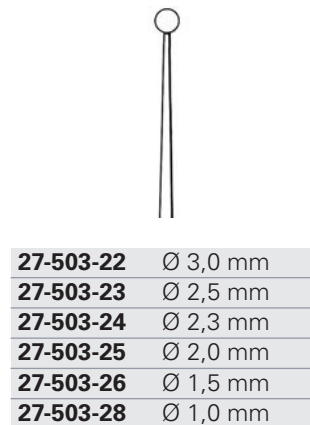
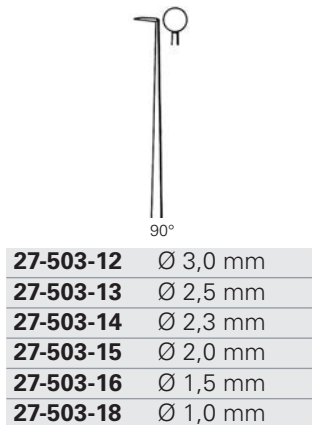
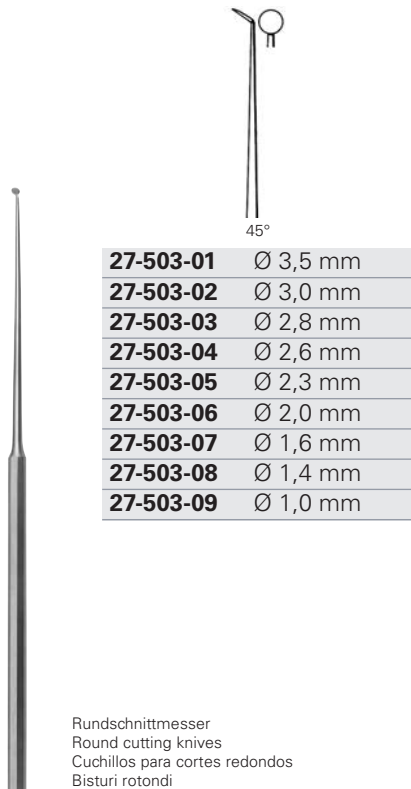

ROSEN







27-503-01 - 27-503-28 16,0 cm, 6 1/4"

	 3,0 x 2,0 mm ROSEN 27-503-43 Lanzettenmesser, 45° Lancet knife, 45° Cuchillo lanceolado, 45° Bisturi lanceolato, 45°	 6,0 x 2,0 mm ROSEN 27-504-01 Transplantat-Träger Graft holder Soporte para transplantes Supporto per trapiantazione	 12,0 x 1,0 mm HOUSE 27-504-02 Raspatorium Raspatory Periostótomo Periostotomo	 2,0 mm ROSEN 27-504-03 Raspatorium Raspatory Periostótomo Periostotomo	 0,6 mm ROSEN 27-504-04 Raspatorium Raspatory Periostótomo Periostotomo
	 2,0 mm PLESTER 27-504-05 Führungsgabel Wire guide Horquilla Forcella di guida	 PLESTER 27-504-06 Exkavator, links Excavator, left Excavador, izquierda Escavatore, sinistra	 PLESTER 27-504-07 Exkavator, rechts Excavator, right Excavador, derecha Escavatore, destra	 2,0 mm ROSEN 27-504-08 Löffel Curette Cucharilla Cucchiola	 0,6 mm ROSEN 27-504-09 Fenestrierhäkchen Fenestra hook Ganchito Gancio fenestrato

27-503-43 - 57-504-09 16,0 cm, 6 1/4"

	 1,8 mm ROSEN 27-504-10 Raspatorium Raspatory Periostótomo Periostotomo	 0,4 mm 90° PLESTER 27-504-11 Häkchen Hook Ganchito Uncino	 27-504-12 Häkchen Hook Ganchito Uncino	 0,8 mm 90° PLESTER 27-504-13 Antrumhäkchen Antrum hook Ganchito para el seno maxilar Uncino per seno mascellare	 45° PLESTER 27-504-14 Antrumhäkchen Antrum hook Ganchito para el seno maxilar Uncino per seno mascellare
	 HUGHES 27-504-15 Steigbügelhäkchen Stirrup hook Ganchito de estribo Uncino per staffa	 27-504-16 Exkavator, links Excavator, left Excavador, izquierda Escavatore, sinistra	 27-504-17 Exkavator, rechts Excavator, right Excavador, derecha Escavatore, destra	 27-504-18 Exkavator, links Excavator, left Excavador, izquierda Escavatore, sinistra	 27-504-19 Exkavator, rechts Excavator, right Excavador, derecha Escavatore, destra

27-504-10 - 27-504-19 16,0 cm, 6 1/4"

27-504-20
Sichelmesser
Sickle knife
Cuchillo en forma de hoz
Bisturi falciforme

0,2 mm | 90°
PLESTER
27-504-22
Antrumhäkchen
Antrum hook
Ganchito para el seno maxilar
Uncino per seno mascellare

3,5 | 4,0 | 4,5 mm
27-508-00
Tiefenmeßsonde
Measuring rod
Sonda para medir
Sonda con indicatore







BARBARA
27-510-01
Mikro-Nadel
Micro needle
Micro aguja
Microaghi

BARBARA
27-510-02
Mikro-Nadel
Micro needle
Micro aguja
Microaghi

BARBARA
27-510-03
Mikro-Nadel
Micro needle
Micro aguja
Microaghi

ROSEN
27-510-04
Mikro-Nadel
Micro needle
Micro aguja
Microaghi

27-504-20 - 27-510-04 16,0 cm, 6 1/4"

2,0 mm
PLESTER
27-510-17
Schaber, 60°
Scraper, 60°
Raspador, 60°
Raspa, 60°

2,0 mm
BEALE
27-510-64
Häkchen
Hook
Ganchito
Uncino

90°
HOUSE
27-506-35 L = 3,5 mm
27-506-40 L = 4,0 mm
27-506-45 L = 4,5 mm
27-506-50 L = 5,0 mm
Mikro-Nadeln
Micro needles
Micro aguja
Microaghi

0,3 mm
27-509-03
0,4 mm
27-509-04
0,5 mm
27-509-05
0,6 mm
27-509-06
Perforatoren
Perforators
Perforadores
Perforatori

27-510-17 - 27-510-64 16,0 cm, 6 1/4"

27-506-35 - 27-509-06 16,0 cm, 6 1/4"

25°

27-510-05	0,3 mm
27-510-06	0,6 mm
27-510-07	1,0 mm

45°

27-510-08	0,4 mm
27-510-09	0,6 mm
27-510-10	0,8 mm
27-510-11	1,0 mm
27-510-18	1,5 mm
27-510-19	2,0 mm
27-510-20	2,5 mm

90°

27-510-12	0,4 mm
27-510-32	0,5 mm
27-510-13	0,6 mm
27-510-14	0,8 mm
27-510-15	1,0 mm
27-510-25	1,2 mm
27-510-26	1,5 mm
27-510-27	2,0 mm
27-510-28	2,5 mm
27-510-29	3,0 mm
27-510-30	4,0 mm
27-510-31	5,0 mm

Mikro-Häkchen
 Micro hooks
 Micro ganchitos
 Microuncini

SHAMBAUGH

27-510-05 - 27-510-32 16,0 cm, 6 ¼ "

27-510-21	0,5 mm
27-510-16	1,0 mm

retrograd gebogen
 curved retrograde
 curvados retrogradados
 curvi retrogradi

Mikro-Häkchen
 Micro hooks
 Micro ganchitos
 Microuncini

BARBARA

27-514-01

ROSEN

27-515-01

Mikro-Nadeln
 Micro needles
 Micro aguja
 Microaghi

SHAMBAUGH

27-510-16 - 27-510-21 16,0 cm, 6 ¼ "

27-514-01 - 27-515-01 16,0 cm, 6 ¼ "

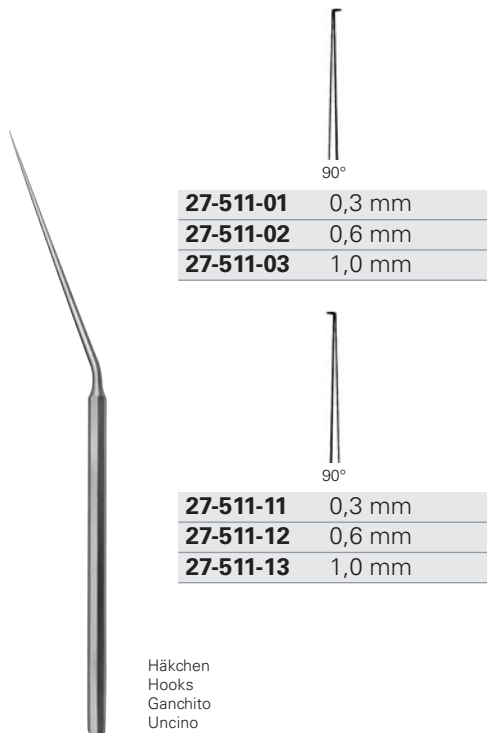

27-511-01 - 27-511-13 16,0 cm, 6 ¼"

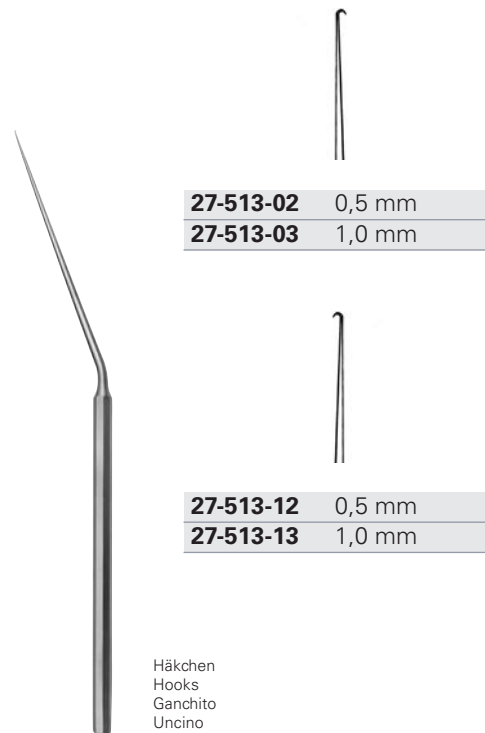

27-513-02 - 27-513-13 16,0 cm, 6 ¼"

MC GEE

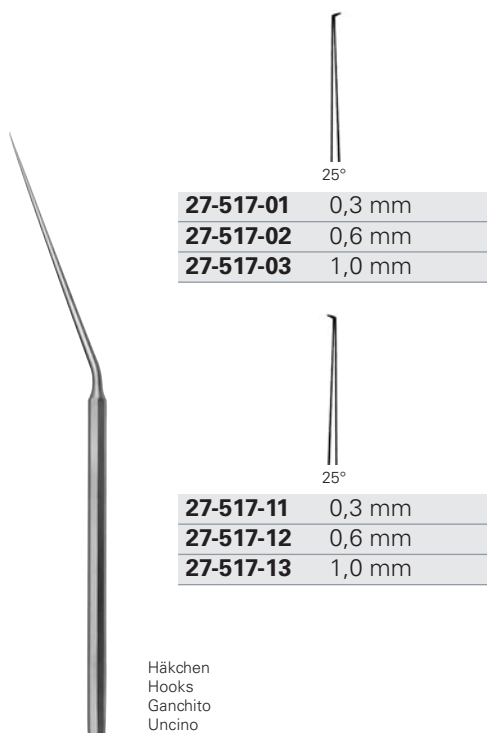

27-517-01 - 27-517-13 16,0 cm, 6 ¼"

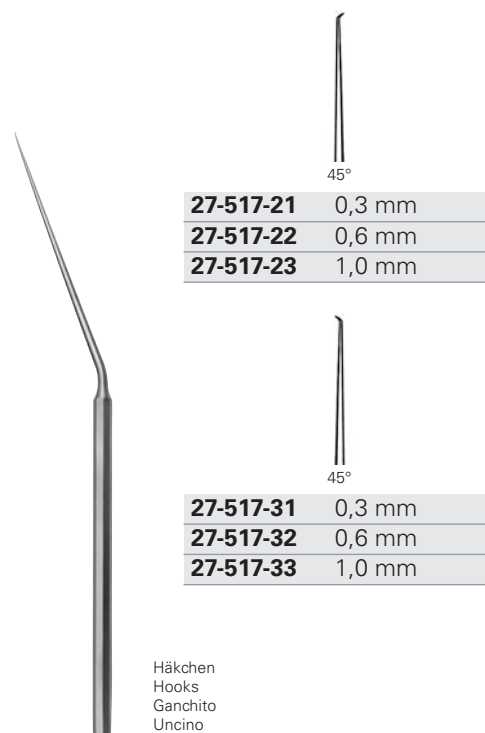

27-517-21 - 27-517-33 16,0 cm, 6 ¼"



SHEA

27-520-01 16,0 cm, 6 ¼"



SHEA

27-521-01 16,0 cm, 6 ¼"

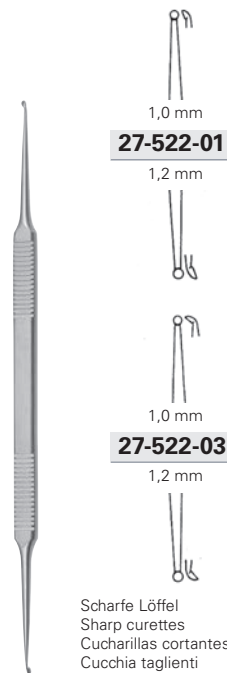

HOUSE

27-522-01 - 27-522-04 16,0 cm, 6 ¼"

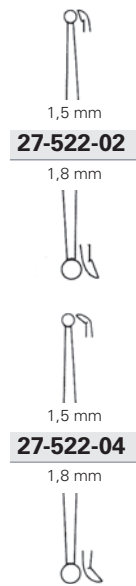

Handgriff für 27-530-01 - 27-530-05
 Handle for 27-530-01 - 27-530-05
 Mango para 27-530-01 - 27-530-05
 Manico per 27-530-01 - 27-530-05

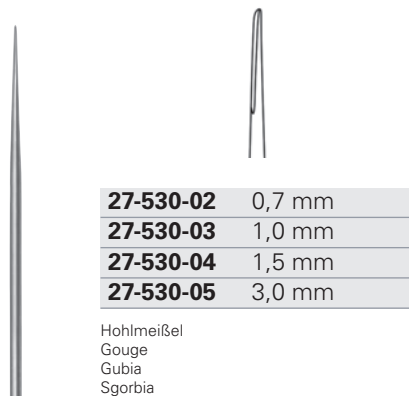

HERMANN

27-530-01 - 27-530-05 9,0 cm, 3 ½"



HERMANN

27-529-00 9,0 cm, 3 ½"



HERMANN

27-532-19 19,5 cm, 7 ¾"

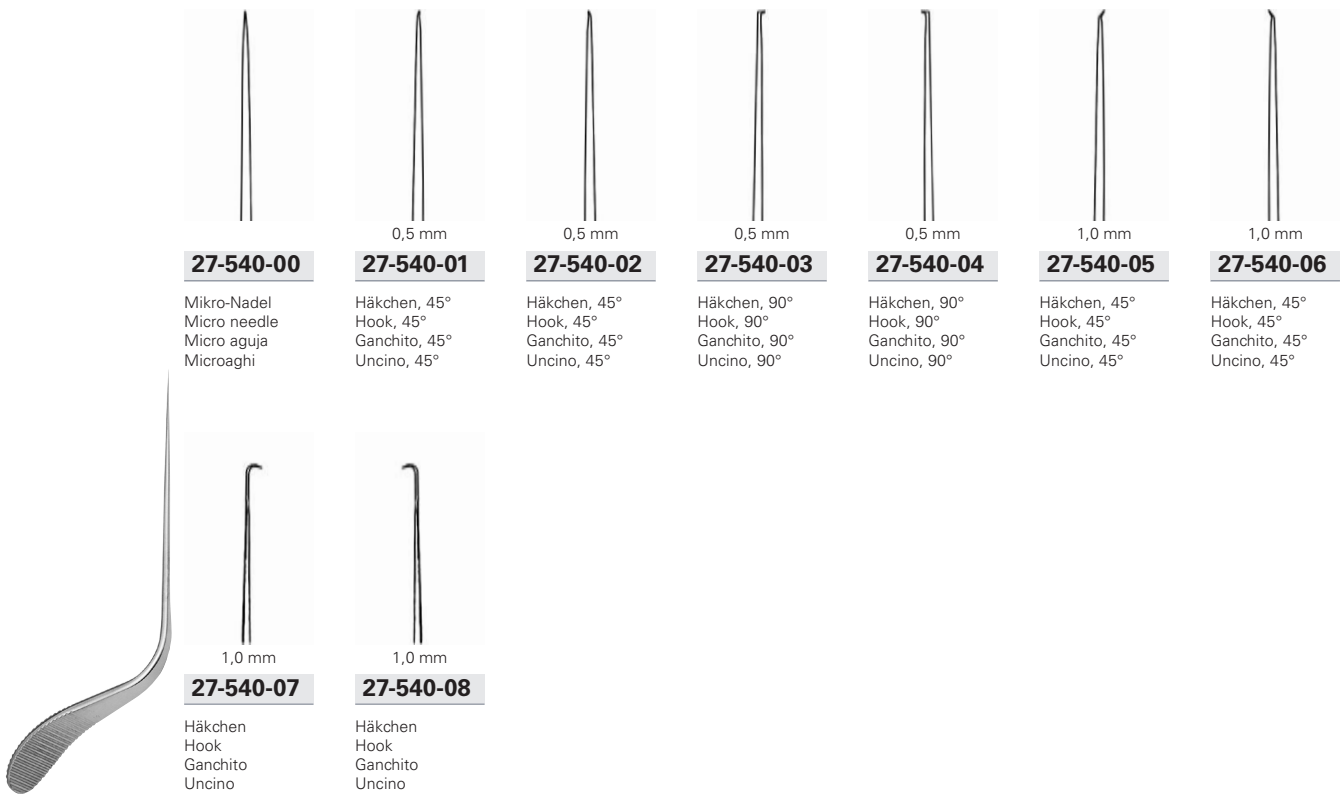

27-540-00

Mikro-Nadel
Micro needle
Micro aguja
Microaghi

27-540-01

Häkchen, 45°
Hook, 45°
Ganchito, 45°
Uncino, 45°

27-540-02

Häkchen, 45°
Hook, 45°
Ganchito, 45°
Uncino, 45°

27-540-03

Häkchen, 90°
Hook, 90°
Ganchito, 90°
Uncino, 90°

27-540-04

Häkchen, 90°
Hook, 90°
Ganchito, 90°
Uncino, 90°

27-540-05

Häkchen, 45°
Hook, 45°
Ganchito, 45°
Uncino, 45°

27-540-06

Häkchen, 45°
Hook, 45°
Ganchito, 45°
Uncino, 45°

27-540-07

Häkchen
Hook
Ganchito
Uncino

27-540-08

Häkchen
Hook
Ganchito
Uncino

ZOELLNER

27-540-00 - 27-540-08 11,0 cm, 4 3/8 "



27-550-01

Rundschnittmesser, 90°
Round cutting knife, 90°
Cuchillos para cortes redondos, 90°
Bisturi rotondi, 90°

27-550-02

27-550-03

Sichelmesser
Sickle knife
Cuchillo en forma de hoz
Bisturi falciforme

27-550-04

27-550-05

Lanzettenmesser
Lancet knife
Cuchillo lanceolado
Bisturi lanceolato

27-550-06

Lanzettenmesser
Lancet knife
Cuchillo lanceolado
Bisturi lanceolato

27-550-09

Führungsgabel
Wire guide
Horquilla
Forcella di guida

27-550-07

Raspatorium, links
Raspatory, left
Periostótomo, izquierda
Periostotomo, sinistra

27-550-08

Raspatorium, rechts
Raspatory, right
Periostótomo, derecha
Periostotomo, destra

ZOELLNER

27-550-01 - 27-550-09 11,0 cm, 4 3/8 "

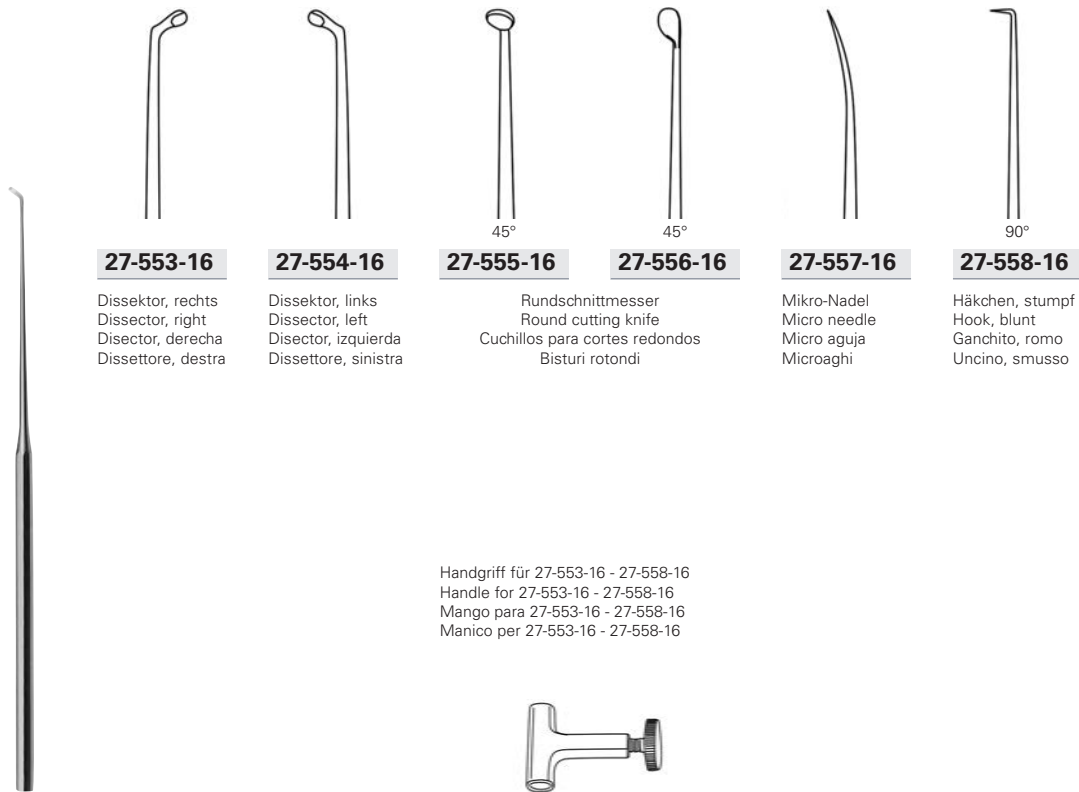

27-553-16

Dissektor, rechts
 Dissector, right
 Disector, derecha
 Dissettore, destra

27-554-16

Dissektor, links
 Dissector, left
 Disector, izquierda
 Dissettore, sinistra

27-555-16

Rundschnittmesser
 Round cutting knife
 Cuchillos para cortes redondos
 Bisturi rotondi

27-556-16

27-557-16

Mikro-Nadel
 Micro needle
 Micro aguja
 Microaghi

27-558-16

Häkchen, stumpf
 Hook, blunt
 Ganchito, romo
 Uncino, smusso

Handgriff für 27-553-16 - 27-558-16
 Handle for 27-553-16 - 27-558-16
 Mango para 27-553-16 - 27-558-16
 Manico per 27-553-16 - 27-558-16



27-553-16 - 27-558-16 16,0 cm, 6 ¼ "

27-559-00

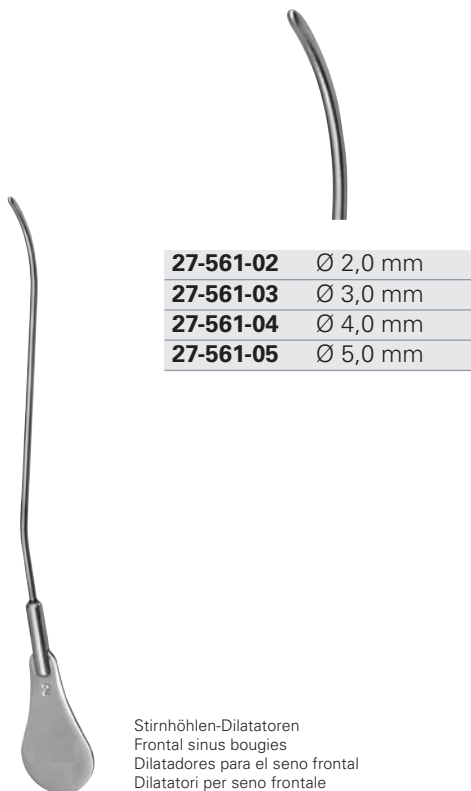

- 27-561-02** Ø 2,0 mm
- 27-561-03** Ø 3,0 mm
- 27-561-04** Ø 4,0 mm
- 27-561-05** Ø 5,0 mm

Stirnhöhlen-Dilatatoren
 Frontal sinus bougies
 Dilatadores para el seno frontal
 Dilatatori per seno frontale

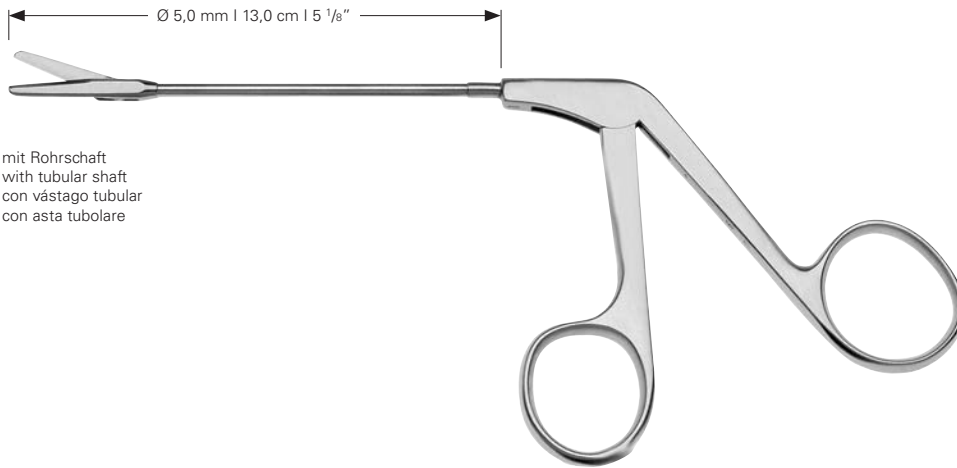

mit Rohrschaft
with tubular shaft
con vástago tubular
con asta tubolare

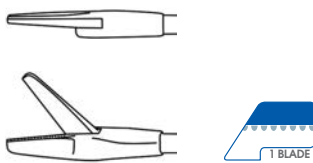

27-600-00

gerade
straight
recta
retta

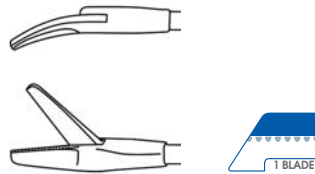

27-600-01

links gebogen
cued left
curva izquierda
curva sinistra

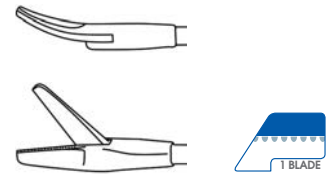

27-600-02

rechts gebogen
cued right
curva derecha
curva destra

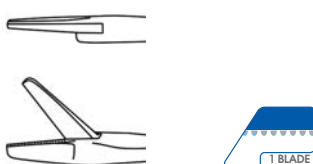
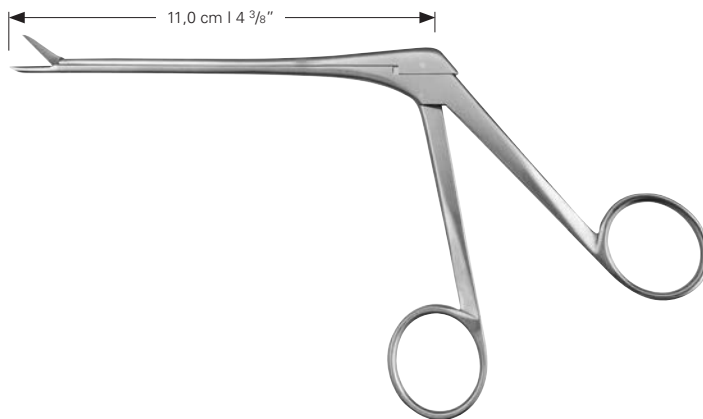

27-600-10

gerade
straight
recta
retta

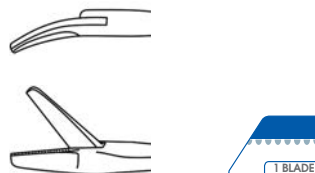

27-600-11

links gebogen
cued left
curva izquierda
curva sinistra

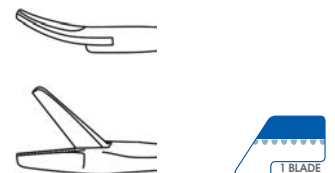

27-600-12

rechts gebogen
cued right
curva derecha
curva destra

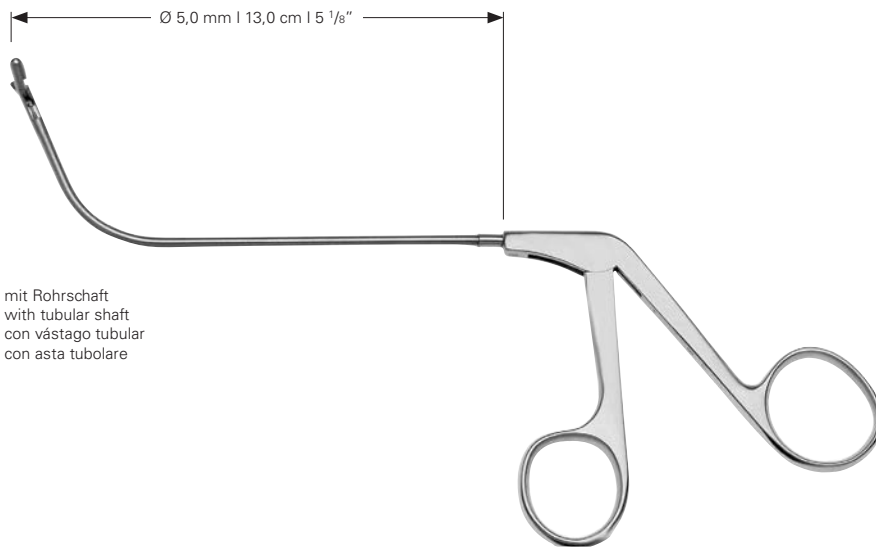

mit Rohrschaft
 with tubular shaft
 con vástago tubular
 con asta tubolare



27-610-03	3,0 mm
27-610-04	4,0 mm

70° aufgebogen, vertikal öffnend
 70° curved upwards, vertical opening
 70° curva hacia arriba, apertura vertical
 70° curvo verso l'alto, apertura verticale

27-611-03	3,0 mm
27-611-04	4,0 mm

70° aufgebogen, horizontal öffnend
 70° curved upwards, horizontal opening
 70° curva hacia arriba, apertura horizontal
 70° curvo verso l'alto, apertura orizzontale

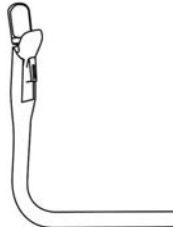
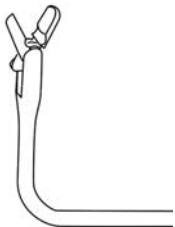

27-612-03	3,0 mm
27-612-04	4,0 mm

90° aufgebogen, vertikal öffnend
 90° curved upwards, vertical opening
 90° curva hacia arriba, apertura vertical
 90° curvo verso l'alto, apertura verticale

27-613-03	3,0 mm
27-613-04	4,0 mm

90° aufgebogen, horizontal öffnend
 90° curved upwards, horizontal opening
 90° curva hacia arriba, apertura horizontal
 90° curvo verso l'alto, apertura orizzontale



27-614-03	3,0 mm
27-614-04	4,0 mm

110° aufgebogen, vertikal öffnend
 110° curved upwards, vertical opening
 110° curva hacia arriba, apertura vertical
 110° curvo verso l'alto, apertura verticale

27-615-03	3,0 mm
27-615-04	4,0 mm

110° aufgebogen, horizontal öffnend
 110° curved upwards, horizontal opening
 110° curva hacia arriba, apertura horizontal
 110° curvo verso l'alto, apertura orizzontale

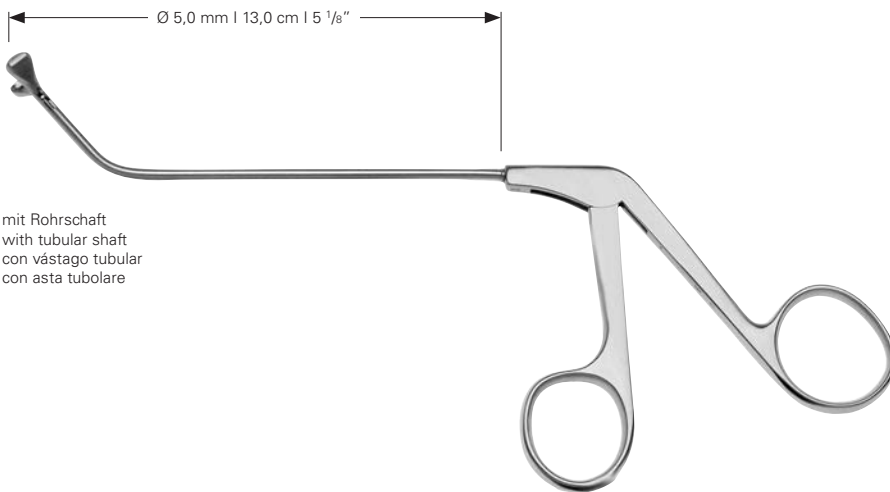

mit Rohrschaft
with tubular shaft
con vástago tubular
con asta tubolare



27-621-45

45° aufgebogen, horizontal öffnend
45° curved upwards, horizontal opening
45° curva hacia arriba, horizontal vertical
45° curvo verso l'alto, orizzontale verticale



27-621-80

80° aufgebogen, horizontal öffnend
80° curved upwards, horizontal opening
80° curva hacia arriba, horizontal vertical
80° curvo verso l'alto, orizzontale verticale

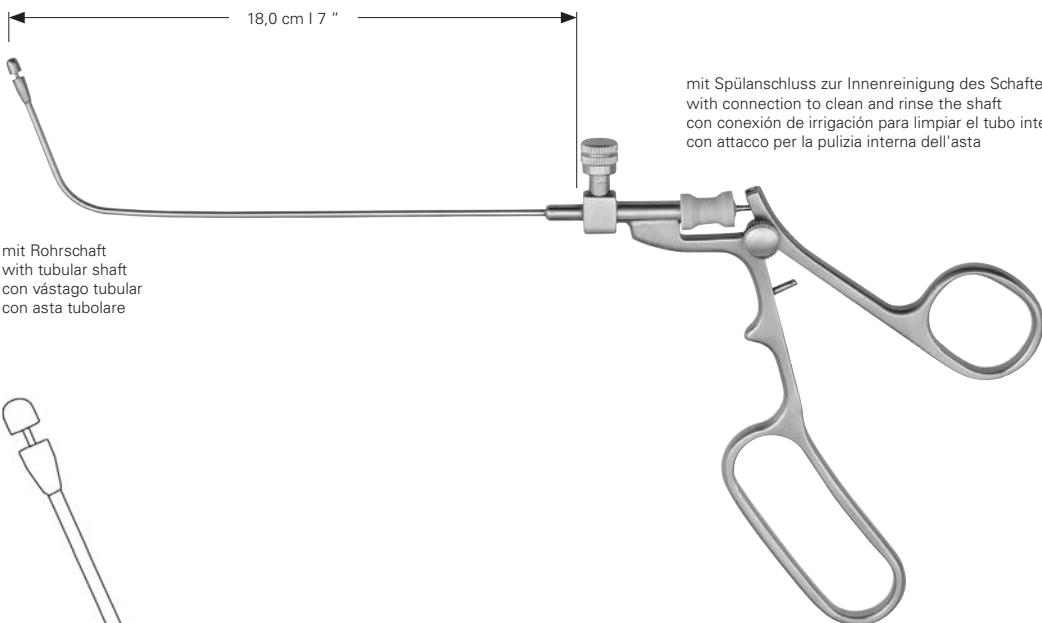

mit Rohrschaft
with tubular shaft
con vástago tubular
con asta tubolare

mit Spülanschluss zur Innenreinigung des Schaftes
with connection to clean and rinse the shaft
con conexión de irrigación para limpiar el tubo interior
con attacco per la pulizia interna dell'asta

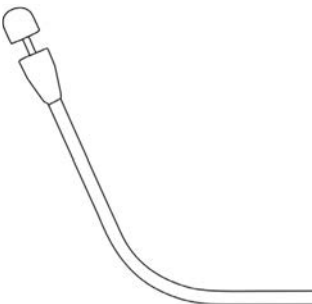

27-623-35 3,5 mm
27-623-45 4,5 mm

65° aufgebogen, 360° zirkulär schneidend
65° curved upwards, cutting in a full circle of 360°
65° curva hacia arriba, corte circular a 360°
65° curvo verso l'alto, angolo di taglio 360°



27-622-35 3,5 mm
27-622-45 4,5 mm

gerade, 360° zirkulär schneidend
straight, cutting in a full circle of 360°
recta, corte circular a 360°
retta, angolo di taglio 360°

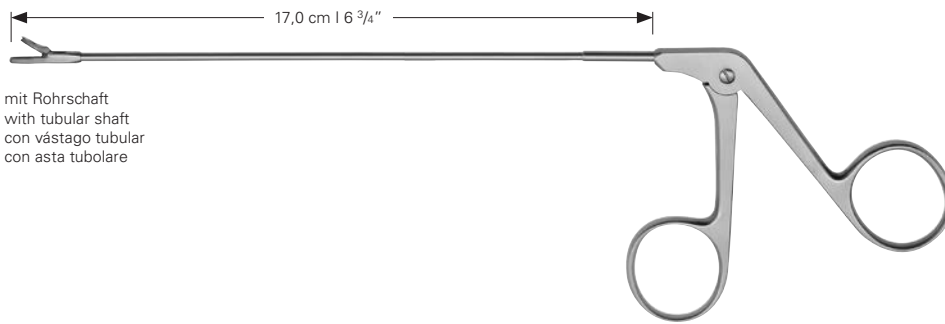

mit Rohrschaft
with tubular shaft
con vástago tubular
con asta tubolare

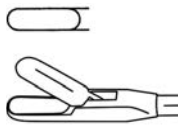

TAKAHASHI

27-626-17

gerade
straight
recta
retta

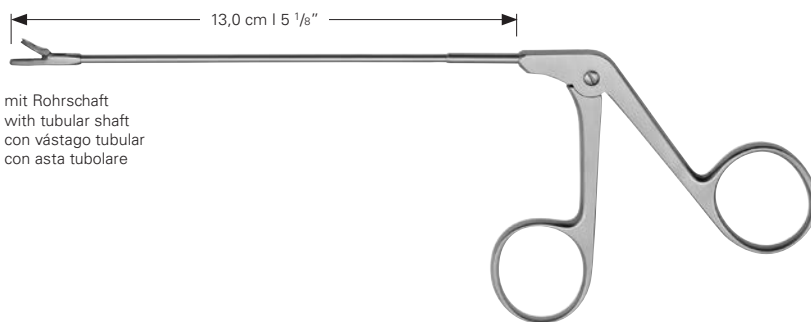

mit Rohrschaft
with tubular shaft
con vástago tubular
con asta tubolare

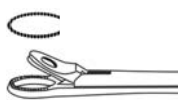

BLAKESLEY

27-628-00	3,0 mm
27-628-01	3,5 mm
27-628-02	4,0 mm

gerade, durchschneidend
straight, through cutting
recta, cortantes
retta, taglienti

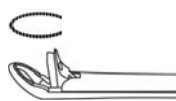

BLAKESLEY

27-629-00	3,0 mm
27-629-01	3,5 mm
27-629-02	4,0 mm

aufgebogen 45°, durchschneidend
curved up 45°, through cutting
curva hacia arriba 45°, cortantes
curvo verso l'alto 45°, taglienti

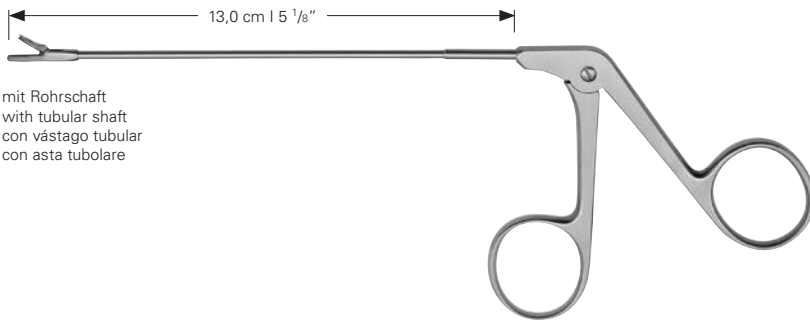

mit Rohrschaft
with tubular shaft
con vástago tubular
con asta tubolare

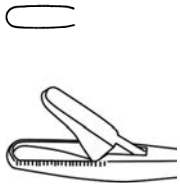

GRUENWALD

27-630-01	8,0 x 3,0 mm
27-630-02	12,0 x 3,0 mm

gerade, durchschneidend
straight, through cutting
recta, cortantes
retta, taglienti



GRUENWALD

27-631-01	8,0 x 3,0 mm
27-631-02	12,0 x 3,0 mm

aufgebogen 45°, durchschneidend
curved up 45°, through cutting
curva hacia arriba 45°, cortantes
curvo verso l'alto 45°, taglienti

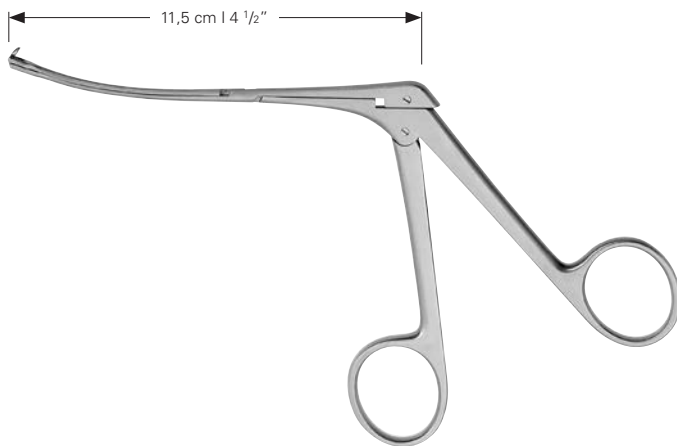

27-655-01 2,5 mm

abgebogen, rückwartsschneidend für Kinder
curved downwards, retrograde cutting for children
curva hacia abajo, corte retrógrado para niños
curvo verso basso, tagliente retrograda per bambini



27-655-03 3,6 mm

abgebogen, rückwartsschneidend für Erwachsene
curved downwards, retrograde cutting for adults
curva hacia abajo, corte retrógrado para adultos
curvo verso basso, tagliente retrograda per adulti



27-655-02 2,5 mm

aufgebogen, rückwartsschneidend für Kinder
curved upwards, retrograde cutting for children
curva hacia arriba, corte retrógrado para niños
curvo verso l'alto, tagliente retrograda per bambini

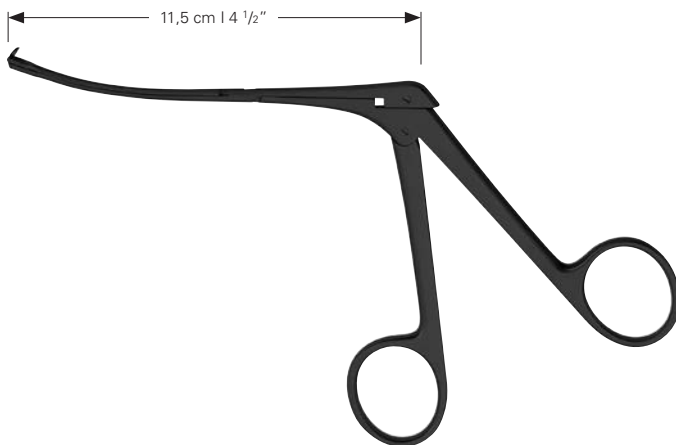

B
CERAMIC



27-655-01 B 2,5 mm

abgebogen, rückwartsschneidend für Kinder
curved downwards, retrograde cutting for children
curva hacia abajo, corte retrógrado para niños
curvo verso basso, tagliente retrograda per bambini

B
CERAMIC



27-655-03 B 3,6 mm

abgebogen, rückwartsschneidend für Erwachsene
curved downwards, retrograde cutting for adults
curva hacia abajo, corte retrógrado para adultos
curvo verso basso, tagliente retrograda per adulti

B
CERAMIC



27-655-02 B 2,5 mm

aufgebogen, rückwartsschneidend für Kinder
curved upwards, retrograde cutting for children
curva hacia arriba, corte retrógrado para niños
curvo verso l'alto, tagliente retrograda per bambini

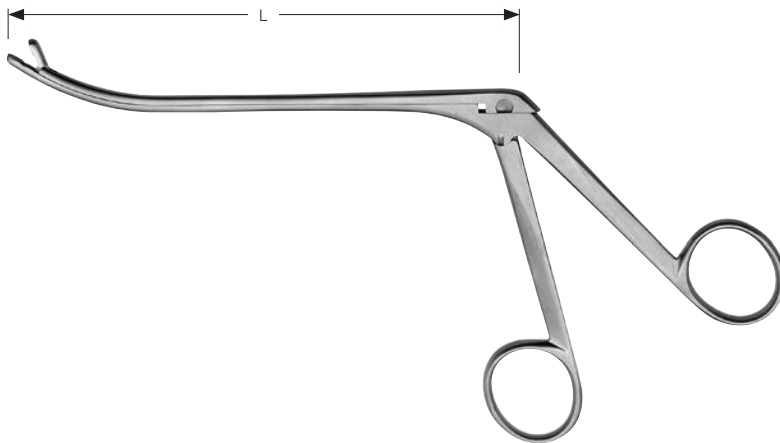

JIKEI

27-650-04 14,0 cm, 5 1/2"

Fig. 4, gerade, fein, oval
Fig. 4, straight, delicate, oval
Fig. 4, recta, fina, oval
Fig. 4, rette, fine, ovale



JIKEI

27-650-05 14,0 cm, 5 1/2"

Fig. 5, aufgebogen, fein, oval
Fig. 5, curved up, delicate, oval
Fig. 6, curva hacia arriba, fina, oval
Fig. 5, curvo verso l'alto, fine, ovale



JIKEI

27-650-01 14,0 cm, 5 1/2"

Fig. 1, gerade, fein, durchschneidend
Fig. 1, straight, delicate, through cutting
Fig. 1, recta, fina, cortantes
Fig. 1, rette, fine, taglienti

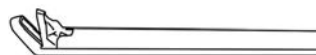

JIKEI

27-650-02 14,0 cm, 5 1/2"

Fig. 2, aufgebogen, fein, durchschneidend
Fig. 2, curved up, delicate, through cutting
Fig. 2, curva hacia arriba, fina, cortantes
Fig. 2, curvo verso l'alto, fine, taglienti

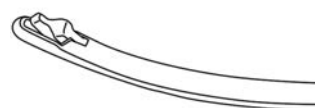

JIKEI

27-650-03 14,0 cm, 5 1/2"

Fig. 3, aufgebogen, fein, durchschneidend
Fig. 3, curved up, delicate, through cutting
Fig. 3, curva hacia arriba, fina, cortantes
Fig. 3, curvo verso l'alto, fine, taglienti



JIKEI

27-650-06 14,0 cm, 5 1/2"

Fig. 6, aufgebogen, fein, oval
Fig. 6, curved up, delicate, oval
Fig. 6, curva hacia arriba, fina, oval
Fig. 6, curvo verso l'alto, fine, ovale

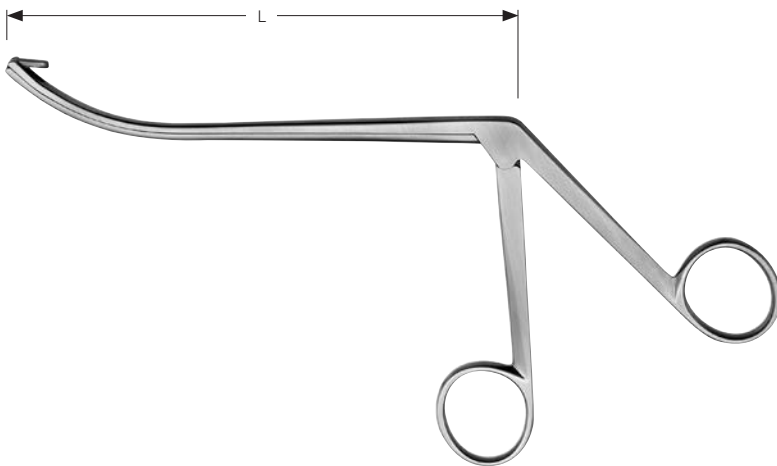

JIKEI

27-650-07 14,0 cm, 5 1/2 "

Fig. 7, aufgebogen, rückwartsschneidend
Fig. 7, curved up, retrograde cutting
Fig. 7, curva hacia arriba, corte retrógrado
Fig. 7, curvo verso l'alto, tagliente retrograda



JIKEI

27-650-08 14,0 cm, 5 1/2 "

Fig. 8, aufgebogen, durchschneidend
Fig. 8, curved up, through cutting
Fig. 8, curva hacia arriba, cortantes
Fig. 8, curvo verso l'alto, taglienti

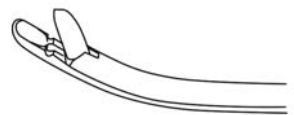

JIKEI

27-650-09 14,0 cm, 5 1/2 "

Fig. 9, aufgebogen, oval
Fig. 9, curved up, oval
Fig. 9, curva hacia arriba, oval
Fig. 9, curvo verso l'alto, ovale



JIKEI

27-650-10 11,5 cm, 4 1/2 "

Fig. 10, gerade, klein, durchschneidend
Fig. 10, straight, small, through cutting
Fig. 10, recta, pequeño, cortantes
Fig. 10, rette, piccolo, taglienti

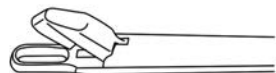

JIKEI

27-650-11 11,5 cm, 4 1/2 "

Fig. 11, gerade, groß, durchschneidend
Fig. 11, straight, large, through cutting
Fig. 11, recta, grande, cortantes
Fig. 11, rette, grande, taglienti



JIKEI

27-650-12 11,5 cm, 4 1/2 "

Fig. 12, aufgebogen, klein, durchschneidend
Fig. 12, curved up, small, through cutting
Fig. 12, curva hacia arriba, pequeño, cortantes
Fig. 12, curvo verso l'alto, piccolo, taglienti

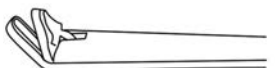

JIKEI

27-650-13 11,5 cm, 4 1/2 "

Fig. 13, aufgebogen, mittel, durchschneidend
Fig. 13, curved up, medium, through cutting
Fig. 13, curva hacia arriba, medio, cortantes
Fig. 13, curvo verso l'alto, medio, taglienti



JIKEI

27-650-14 11,5 cm, 4 1/2 "

Fig. 14, aufgebogen, groß, durchschneidend
Fig. 14, curved up, large, through cutting
Fig. 14, curva hacia arriba, grande, cortantes
Fig. 14, curvo verso l'alto, grande, taglienti



GRUENWALD

27-660-00 SET

Komplett in Ständer, bestehend aus:

1 Kanüle, gerade	27-660-01
1 Kanüle, abgebogen	27-660-02
1 Kanüle, aufgebogen	27-660-03
3 Glasflakons	27-660-04

Complete in rack, consisting of:

1 Cannula, straight	27-660-01
1 Cannula, curved down	27-660-02
1 Cannula, curved up	27-660-03
3 Flasks	27-660-04

Completo en soporte, compuesto de:

1 Cánula, recta	27-660-01
1 Cánula, hacia abajo	27-660-02
1 Cánula, hacia arriba	27-660-03
3 Frascos	27-660-04

Completo con supporto, composto da:

1 Cannula, retta	27-660-01
1 Cannula, curva in basso	27-660-02
1 Cannula, curva in alto	27-660-03
3 Bottiglie	27-660-04



GRUENWALD

27-660-05

Halbgebläse
Rubber bulb
Pera de goma
Pera di gomma



GRUENWALD

27-660-04

Ersatzglas
Spare flask
Frasquito de repuesto
Bottiglia di ricambio



30



Thorax, Lunge

Thorax, Lung

Thorácio, Pulmòn

Thorace, Pulmone



30-100-23 23,0 cm, 9 "



30-101-22 23,0 cm, 9 "



GLUCK

30-103-22 22,0 cm, 8 ¾ "



SCHUMACHER

30-106-21 22,0 cm, 8 ¾ "



LEBSCHKE

30-109-24 24,0 cm, 9 ½ "

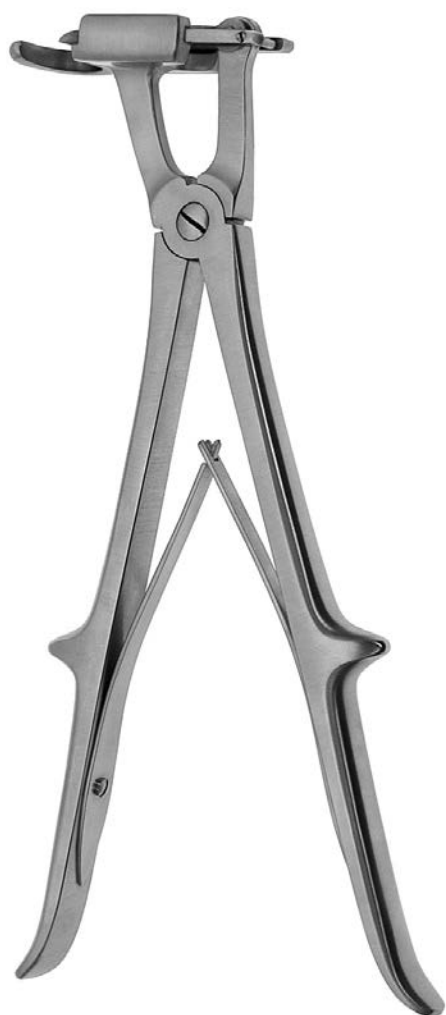

SAUERBRUCH

30-110-24	24,0 cm, 9 1/2 "
30-110-27	27,0 cm, 10 3/4 "



BETHUNE

30-111-34	34,0 cm, 13 1/3 "
------------------	-------------------

links
left
izquierda
sinistra



CORYLLOS

30-111-35 35,0 cm, 13 3/4"

rechts
right
derecha
destra



CORYLLOS

30-111-36 35,0 cm, 13 3/4"



SAUERBRUCH-FREY

30-112-37 37,0 cm, 14 1/2"



GIERTZ-STILLE

30-117-27 27,0 cm, 10 3/4"

rechts
right
derecha
destra



BRUNNER

30-113-28 32,0 cm, 12 1/2"

links
left
izquierda
sinistra



BRUNNER

30-115-28 32,0 cm, 12 1/2"

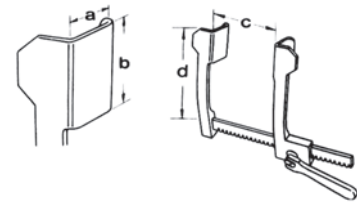

für Säuglinge
 for infants
 para bebés
 per neonati

COOLEY

AL
 ALUMINIUM

	a	b	c	d
30-201-00	14,0 mm	16,0 mm	85,0 mm	55,0 mm

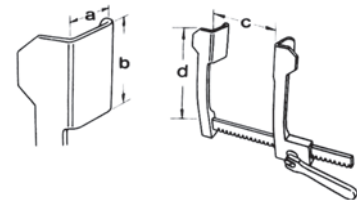

für Kinder
 for children
 para niños
 per bambini

COOLEY

AL
 ALUMINIUM

	a	b	c	d
30-202-00	15,0 mm	30,0 mm	115,0 mm	80,0 mm
30-202-01	15,0 mm	30,0 mm	140,0 mm	80,0 mm

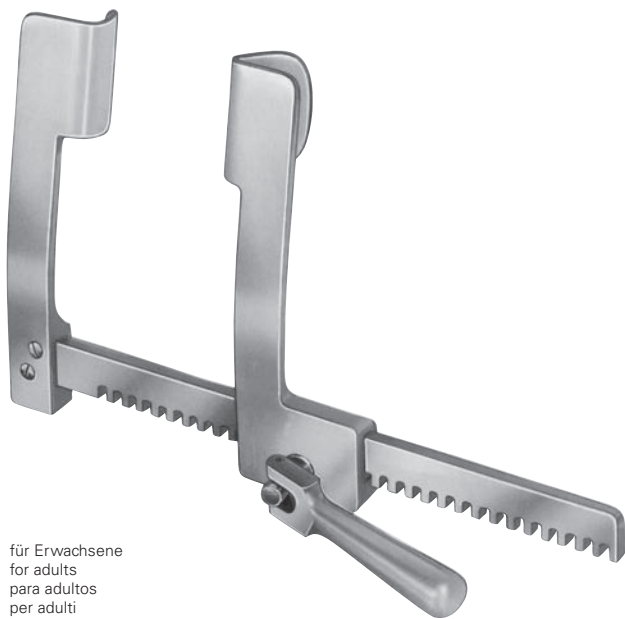

für Erwachsene
for adults
para adultos
per adulti

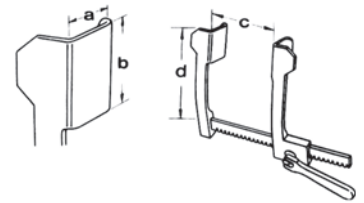

COOLEY



	a	b	c	d
30-203-00	20,0 mm	45,0 mm	140,0 mm	110,0 mm
30-204-00	30,0 mm	50,0 mm	185,0 mm	145,0 mm

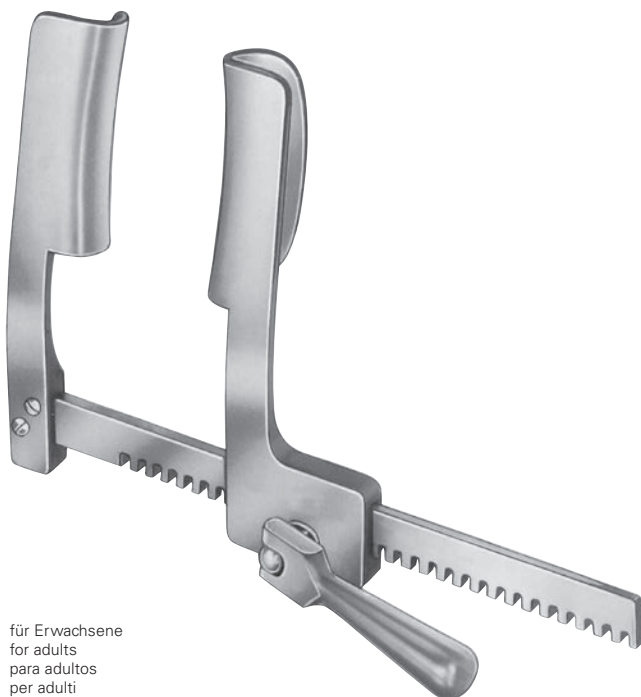

für Erwachsene
for adults
para adultos
per adulti

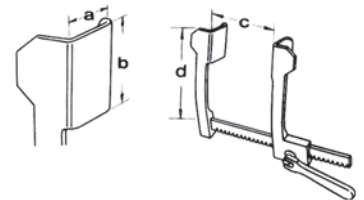

COOLEY



	a	b	c	d
30-204-10	35,0 mm	100,0 mm	180,0 mm	180,0 mm
30-204-30	35,0 mm	115,0 mm	230,0 mm	205,0 mm

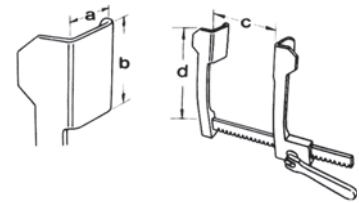
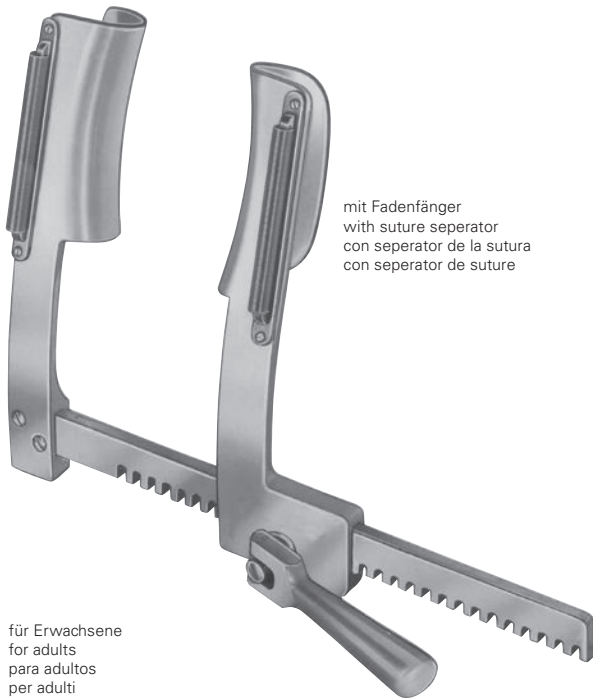

COOLEY

AL
 ALUMINIUM

	a	b	c	d
30-204-20	35,0 mm	100,0 mm	180,0 mm	180,0 mm

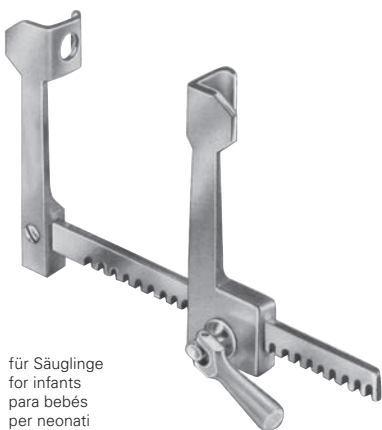
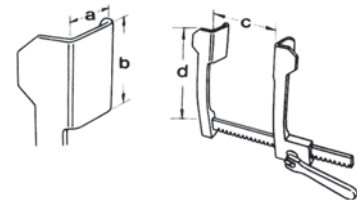

FINOCHIETTO

AL
 ALUMINIUM

	a	b	c	d
30-205-00	12,0 mm	15,0 mm	70,0 mm	55,0 mm
30-205-01	12,0 mm	15,0 mm	100,0 mm	55,0 mm



für Kinder
for children
para niños
per bambini

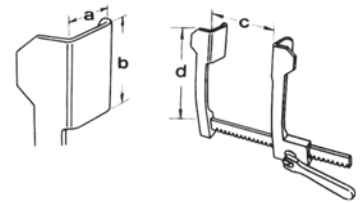

FINOCHIETTO



	a	b	c	d
30-206-00	27,0 mm	30,0 mm	95,0 mm	80,0 mm
30-207-00	30,0 mm	45,0 mm	140,0 mm	110,0 mm

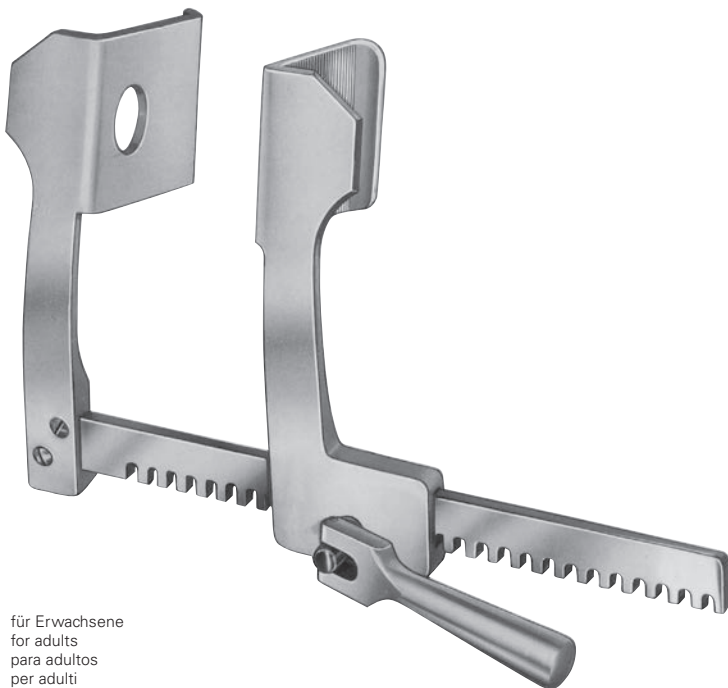

für Erwachsene
for adults
para adultos
per adulti

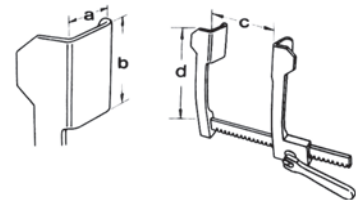

FINOCHIETTO



	a	b	c	d
30-208-00	42,0 mm	62,0 mm	170,0 mm	140,0 mm
30-209-00	73,0 mm	65,0 mm	170,0 mm	140,0 mm

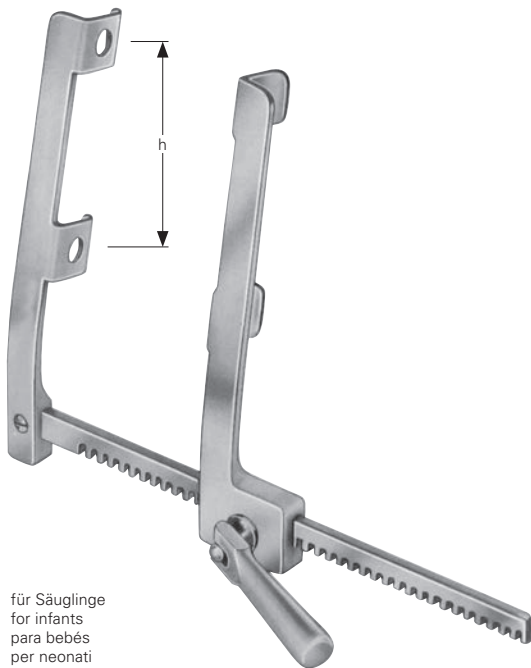

für Säuglinge
 for infants
 para bebés
 per neonati

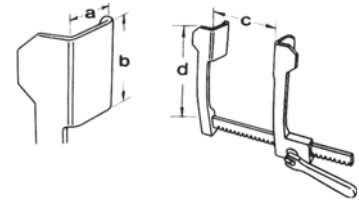

FINOCHIETTO (modif.)

AL
 ALUMINIUM

	h	a	b	c	d
30-210-00	40,0 mm	10,0 mm	15,0 mm	120,0 mm	105,0 mm



für Säuglinge
 for infants
 para bebés
 per neonati

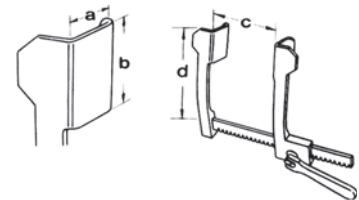

CASTANEDA

AL
 ALUMINIUM

	a	b	c	d
30-211-00	10,0 mm	30,0 mm	65,0 mm	55,0 mm
30-212-00	12,0 mm	45,0 mm	72,0 mm	80,0 mm



für Kinder
for children
para niños
per bambini

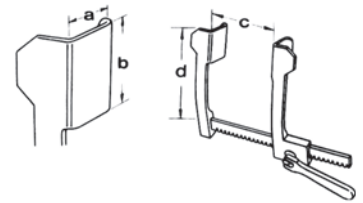

CASTANEDA



	a	b	c	d
30-213-00	15,0 mm	60,0 mm	100,0 mm	125,0 mm

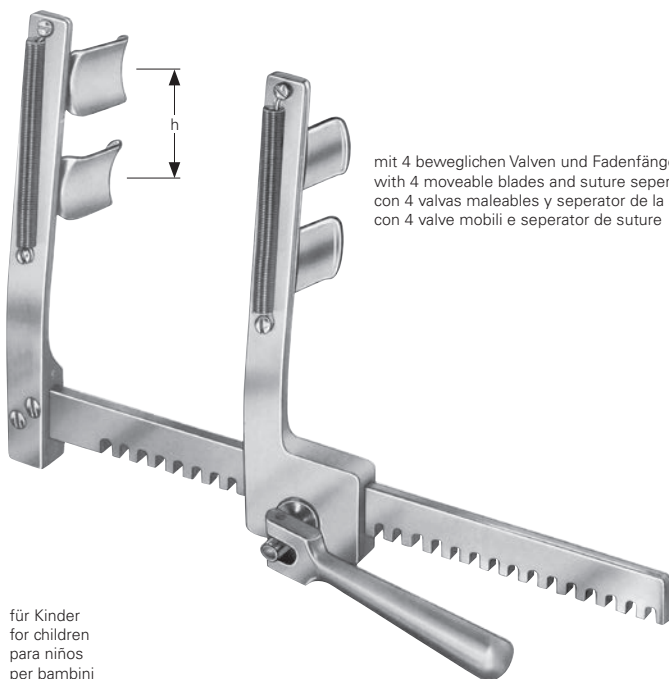

für Kinder
for children
para niños
per bambini

mit 4 beweglichen Valven und Fadenfänger
with 4 moveable blades and suture separator
con 4 valvas maleables y separator de la sutura
con 4 valve mobili e separator de sutura

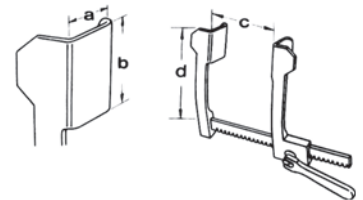

ANKENEV



	h	a	b	c	d
30-214-00	30,0 mm	20,0 mm	20,0 mm	160,0 mm	115,0 mm

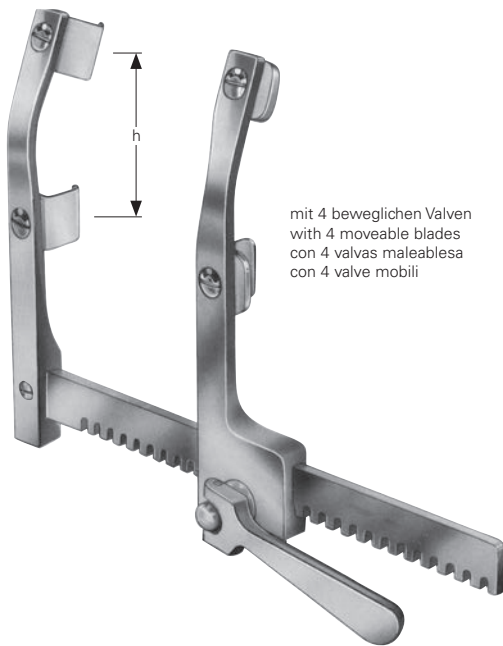

mit 4 beweglichen Valven
 with 4 moveable blades
 con 4 valvas maleablesa
 con 4 valve mobili

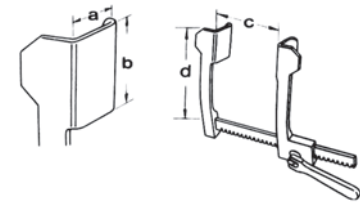

30-215-00 - 30-216-00 für Kinder
 for children
 para niños
 per bambini

30-217-00 - 30-218-00 für Erwachsene
 for adults
 para adultos
 per adulti

FAVALORO I MORSE

AL
 ALUMINIUM

	h	a	b	c	d
30-215-00	50,0 mm	17,0 mm	22,0 mm	160,0 mm	120,0 mm
30-216-00	50,0 mm	20,0 mm	20,0 mm	155,0 mm	120,0 mm
30-217-00	65,0 mm	40,0 mm	20,0 mm	155,0 mm	175,0 mm
30-218-00	72,0 mm	40,0 mm	28,0 mm	210,0 mm	155,0 mm

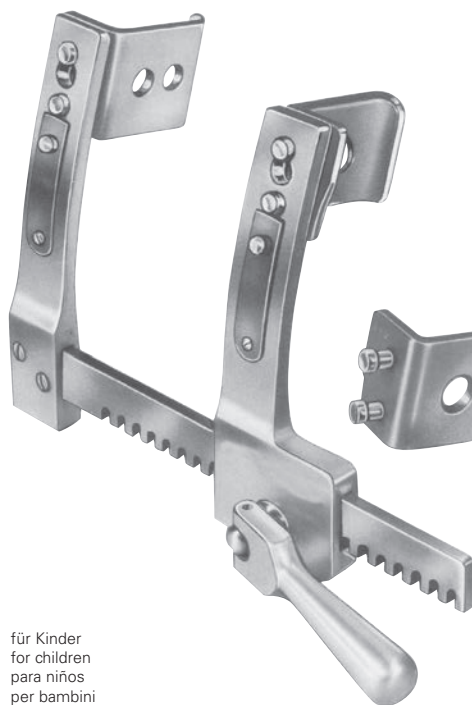

mit 2 Paar Valven (V1 | V2)
 with 2 pairs of valves (V1 | V2)
 con 2 pares de valvas (V1 | V2)
 con 2 paia de valve (V1 | V2)

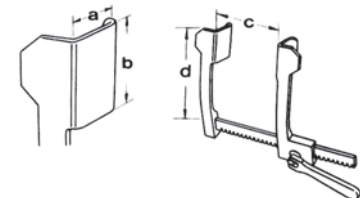

für Kinder
 for children
 para niños
 per bambini

BURFORD

BURFORD

30-222-10 V1 30 x 42 mm
30-222-11 V2 41 x 42 mm

Valvenpaar
 Pairs of valves
 Pares de valvas
 paia di valve

AL
 ALUMINIUM

	a		b		c	d
	V1	V2	V1	V2		
30-222-00	30,0 mm	41,0 mm	42,0 mm	42,0 mm	130,0 mm	117,0 mm

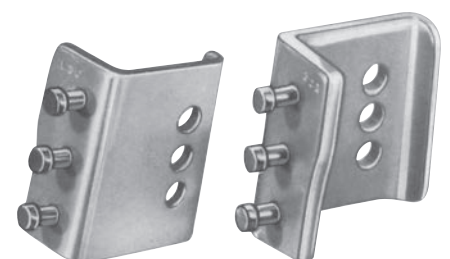
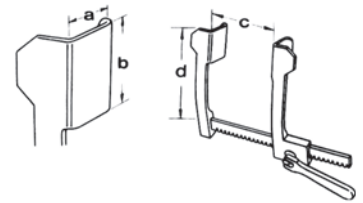

für Erwachsene
for adults
para adultos
per adulti

BURFORD

30-225-10 V1 45 x 62 mm

30-225-11 V2 65 x 62 mm

Valvenpaar
Pairs of valves
Pares de valvas
paia di valve

BURFORD

	a		b		c	d
	V1	V2	V1	V2		
30-223-00	45,0 mm	65,0 mm	62,0 mm	62,0 mm	200,0 mm	200,0 mm
30-224-00	45,0 mm	65,0 mm	62,0 mm	62,0 mm	250,0 mm	200,0 mm
30-225-00	45,0 mm	65,0 mm	62,0 mm	62,0 mm	300,0 mm	200,0 mm



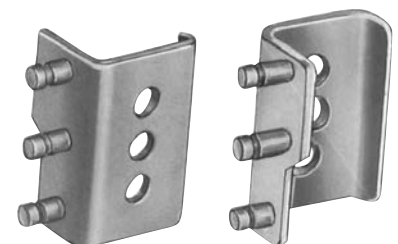
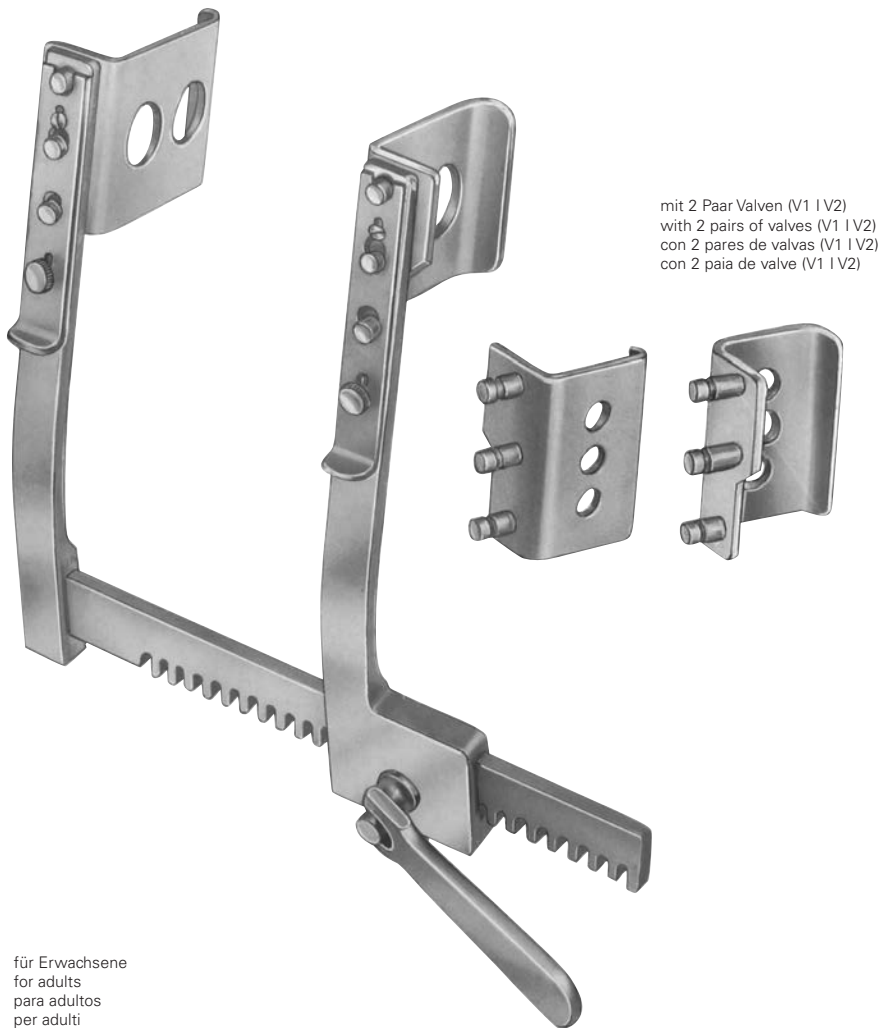
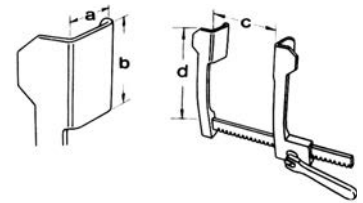

BURFORD

30-227-01 V1 40 x 65 mm

30-227-02 V2 72 x 65 mm

Valvenpaar
 Pairs of valves
 Pares de valvas
 paia di valve

für Erwachsene
 for adults
 para adultos
 per adulti

BURFORD



	a		b		c	d
	V1	V2	V1	V2		
30-226-00	40,0 mm	72,0 mm	65,0 mm	65,0 mm	200,0 mm	195,0 mm
30-226-10	40,0 mm	72,0 mm	65,0 mm	65,0 mm	250,0 mm	195,0 mm
30-227-00	40,0 mm	72,0 mm	65,0 mm	65,0 mm	300,0 mm	195,0 mm



mit 4 beweglichen Valven
with 4 moveable blades
con 4 valvas maleablesa
con 4 valve mobili

für Kinder
for children
para niños
per bambini

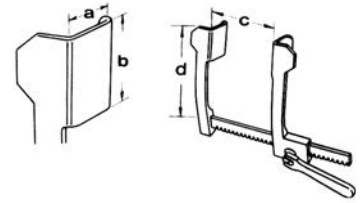

MORSE-FAVALORO

	h	a	b	c	d
30-228-00	50,0 mm	12,0 mm	20,0 mm	155,0 mm	120,0 mm

STEEL
STAINLESS

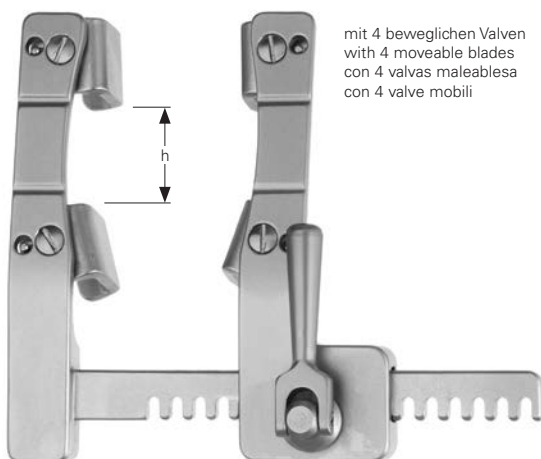

mit 4 beweglichen Valven
with 4 moveable blades
con 4 valvas maleablesa
con 4 valve mobili

für Kinder
for children
para niños
per bambini

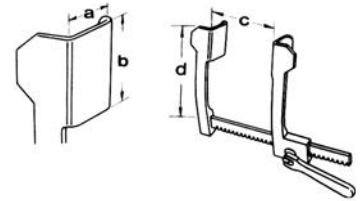

MORSE

	h	a	b	c	d
30-228-10	18,0 mm	15,0 mm	12,0 mm	46,0 mm	56,0 mm
30-228-11	18,0 mm	15,0 mm	12,0 mm	65,0 mm	56,0 mm
30-228-12	41,0 mm	23,0 mm	20,0 mm	100,0 mm	148,0 mm
30-228-13	41,0 mm	23,0 mm	20,0 mm	130,0 mm	148,0 mm
30-228-14	41,0 mm	23,0 mm	20,0 mm	160,0 mm	148,0 mm

STEEL
STAINLESS

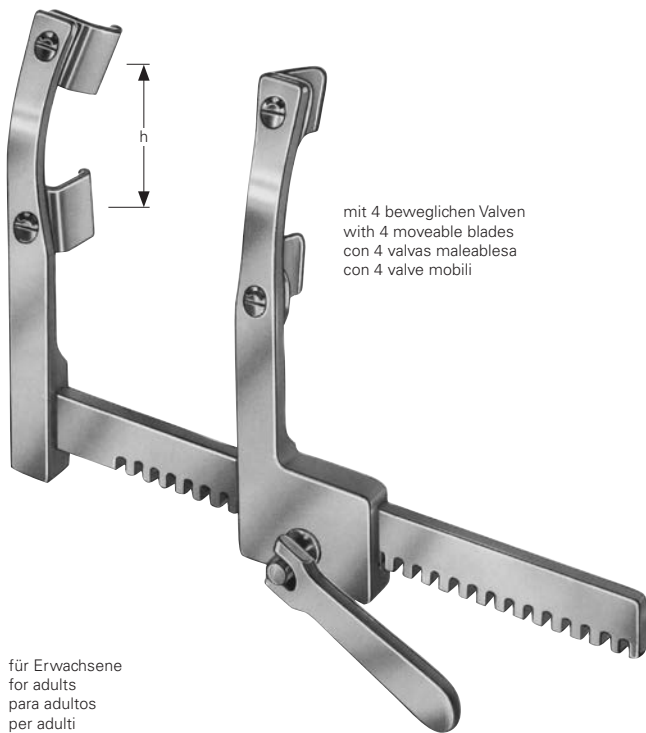

mit 4 beweglichen Valven
with 4 moveable blades
con 4 valvas maleables
con 4 valve mobili

für Erwachsene
for adults
para adultos
per adulti

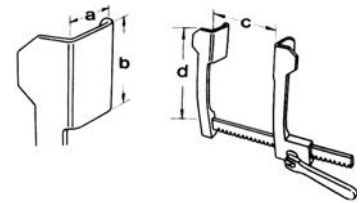

MORSE

STEEL
STAINLESS

	h	a	b	c	d
30-229-00	72,0 mm	20,0 mm	28,0 mm	200,0 mm	150,0 mm



mit 2 beweglichen Valven
with 2 moveable blades
con 2 valvas maleables
con 2 valve mobili

für Säuglinge
for infants
para bebés
per neonati

TURN-OVER

STEEL
STAINLESS

	a	b	c	d
30-230-00	10,0 mm	30,0 mm	65,0 mm	65,0 mm
30-230-01	14,0 mm	45,0 mm	80,0 mm	75,0 mm
30-230-02	18,0 mm	58,0 mm	90,0 mm	85,0 mm

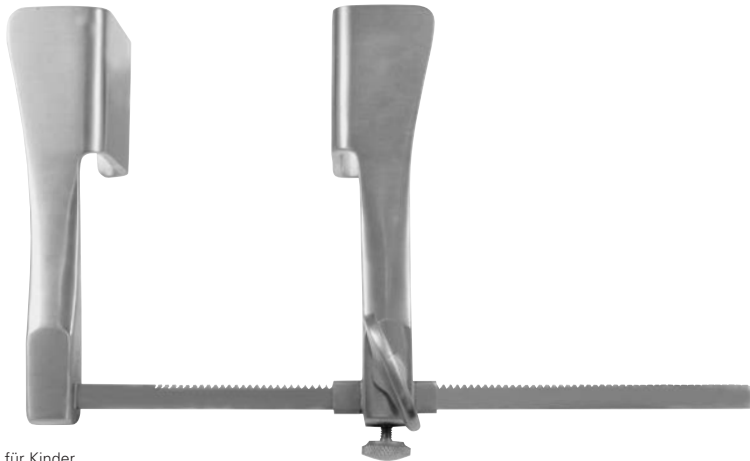
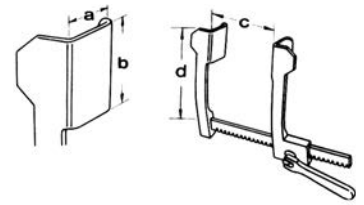

für Kinder
for children
para niños
per bambini

TUFFIER

	a	b	c	d
30-231-00	42,0 mm	45,0 mm	170,0 mm	110,0 mm

STEEL
STAINLESS

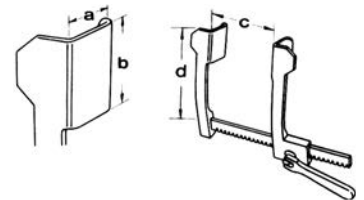

HERTZLER

	a	b	c	d
30-232-00	20,0 mm	25,0 mm	105,0 mm	120,0 mm

STEEL
STAINLESS

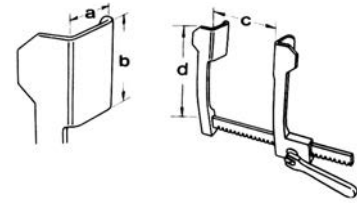

für Kinder
 for children
 para niños
 per bambini

HAIGHT

STEEL
 STAINLESS

	a	b	c	d
30-233-00	30,0 mm	30,0 mm	120,0 mm	90,0 mm
30-233-01	30,0 mm	30,0 mm	120,0 mm	64,0 mm

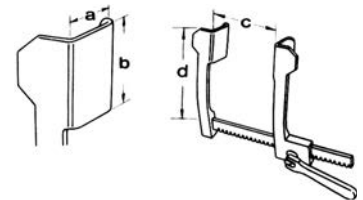

für Erwachsene
 for adults
 para adultos
 per adulti

CHEVALIER

STEEL
 STAINLESS

	a	b	c	d
30-234-00	30,0 mm	100,0 mm	210,0 mm	185,0 mm

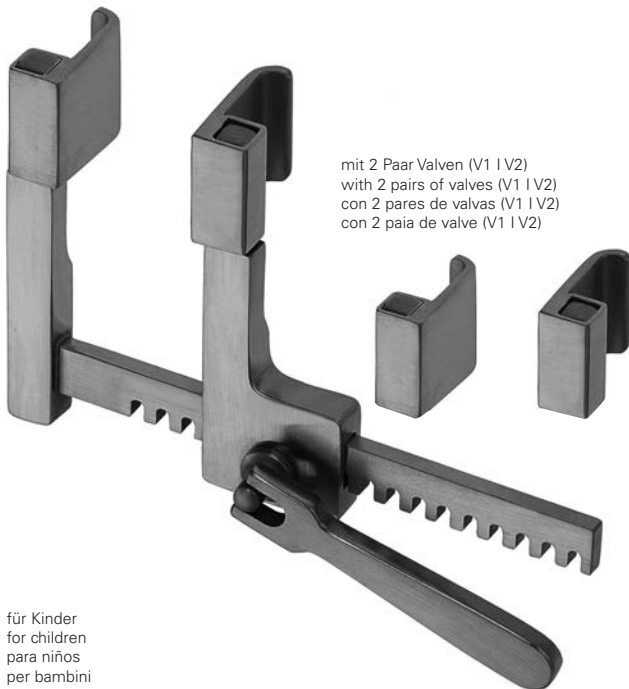

für Kinder
for children
para niños
per bambini

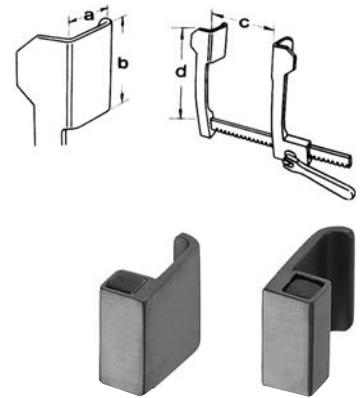

STRUCK

30-235-06

Sperrer allein
Spreader only
Separador solo
Divaricatore suelto

STRUCK

30-235-01	10 x 10 mm
30-235-02	10 x 15 mm
30-235-03	10 x 20 mm
30-235-04	V1 15 x 20 mm
30-235-05	V2 20 x 20 mm

Valvenpaar
Pair of valves
Pares de valvas
paia di valve

STRUCK

	a		b			c	d	
	V1	l	V2	V1	l	V2		
30-235-00	15,0 mm	l	20,0 mm	20,0 mm	l	20,0 mm	70,0 mm	64,0 mm



für Kinder
for children
para niños
per bambini

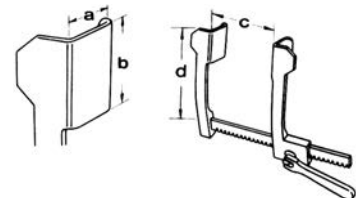

RIENHOFF

	a	b	c	d
30-235-50	30,0 mm	33,0 mm	140,0 mm	116,0 mm
30-235-51	47,0 mm	45,0 mm	140,0 mm	146,0 mm

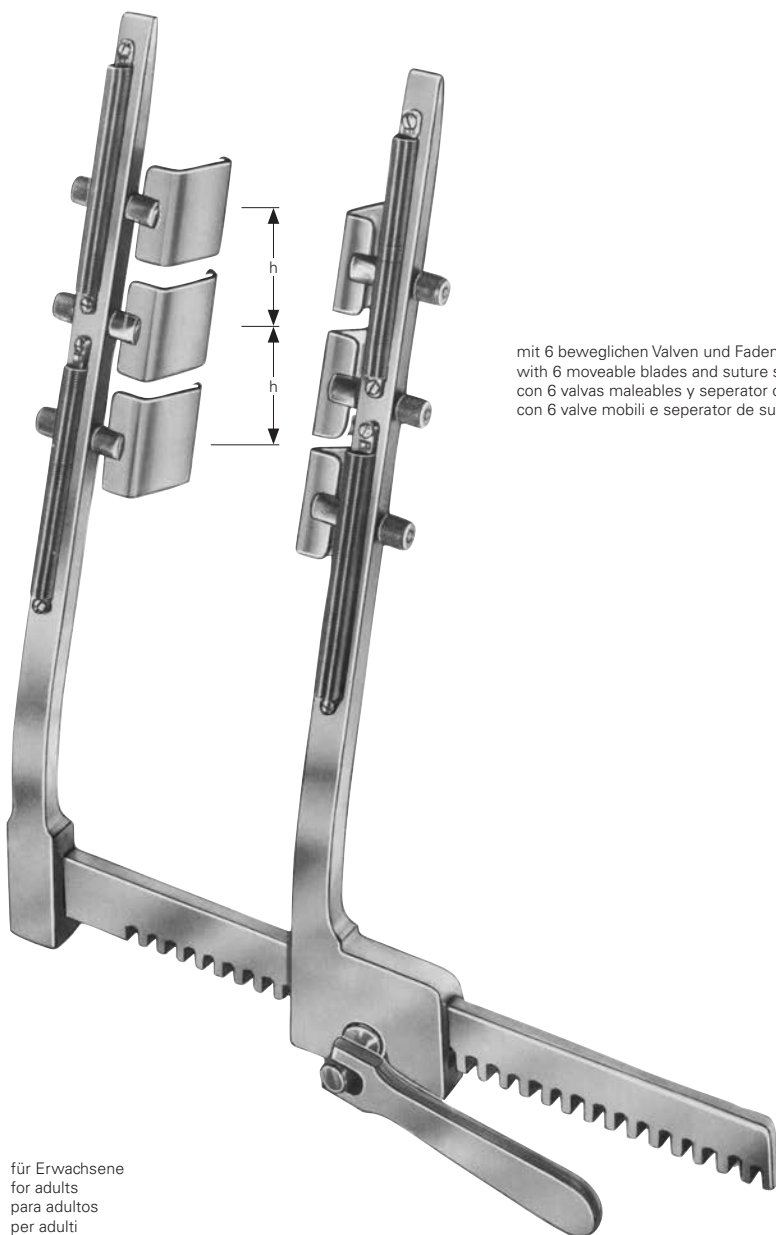
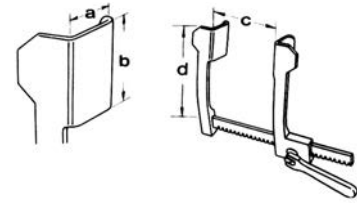

mit 6 beweglichen Valven und Fadenfänger
 with 6 moveable blades and suture separator
 con 6 valvas maleables y separator de la sutura
 con 6 valve mobili e separator de suture

für Erwachsene
 for adults
 para adultos
 per adulti

ANKENEY

STEEL
 STAINLESS

	h	a	b	c	d
30-236-00	45,0 mm	33,0 mm	35,0 mm	180,0 mm	300,0 mm



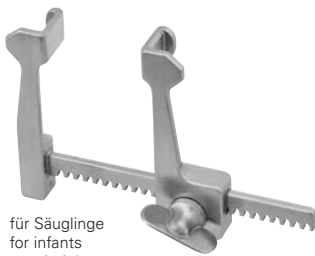
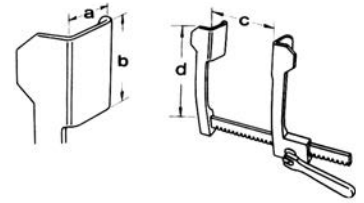

für Säuglinge
for infants
para bebés
per neonati

FINOCHIETTO

	a	b	c	d
30-236-50	6,0 mm	7,0 mm	36,0 mm	25,0 mm

STEEL
STAINLESS

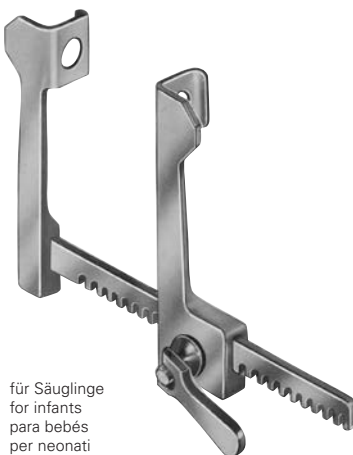
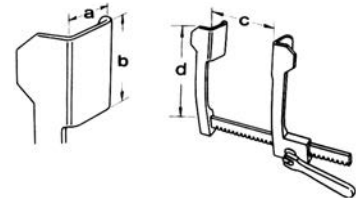

für Säuglinge
for infants
para bebés
per neonati

FINOCHIETTO

	a	b	c	d
30-237-00	14,0 mm	15,0 mm	55,0 mm	55,0 mm
30-238-00	19,0 mm	20,0 mm	75,0 mm	55,0 mm

STEEL
STAINLESS



für Kinder
 for children
 para niños
 per bambini

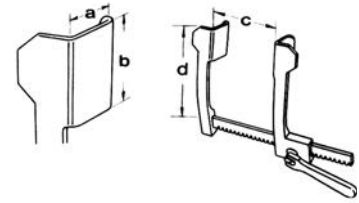

FINOCHIETTO

STEEL
 STAINLESS

	a	b	c	d
30-239-00	28,0 mm	30,0 mm	100,0 mm	75,0 mm
30-240-00	30,0 mm	45,0 mm	140,0 mm	110,0 mm

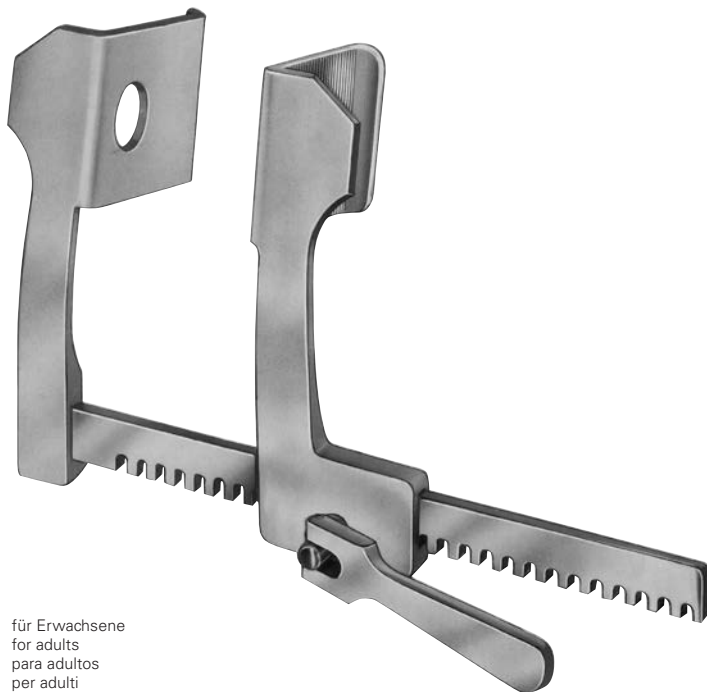

für Erwachsene
 for adults
 para adultos
 per adulti

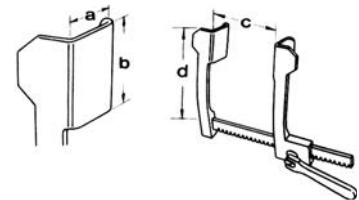

FINOCHIETTO

STEEL
 STAINLESS

	a	b	c	d
30-241-00	42,0 mm	62,0 mm	185,0 mm	140,0 mm
30-242-00	73,0 mm	65,0 mm	185,0 mm	140,0 mm

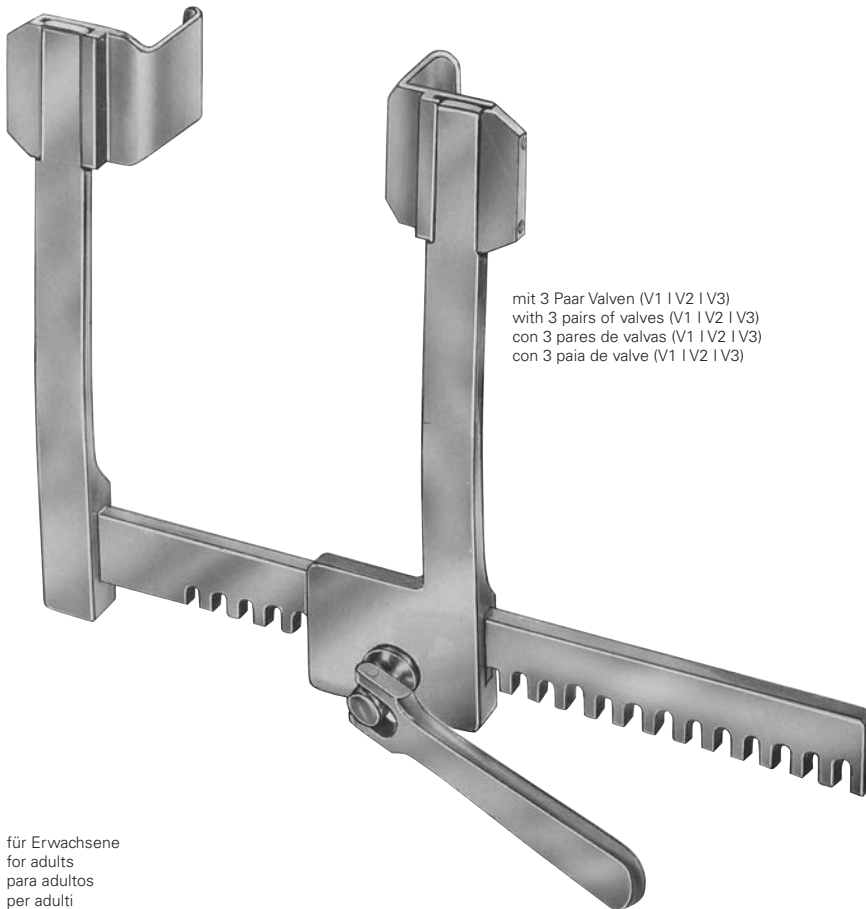
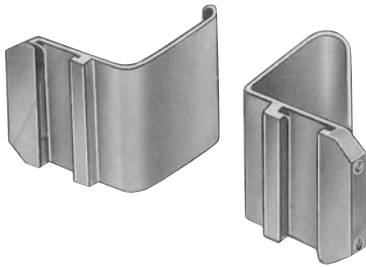

mit 3 Paar Valven (V1 | V2 | V3)
with 3 pairs of valves (V1 | V2 | V3)
con 3 pares de valvas (V1 | V2 | V3)
con 3 paia de valve (V1 | V2 | V3)

für Erwachsene
for adults
para adultos
per adulti

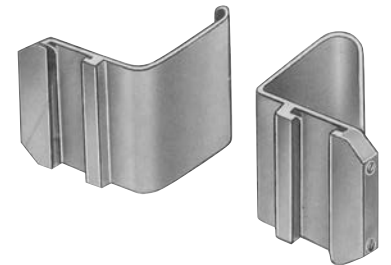
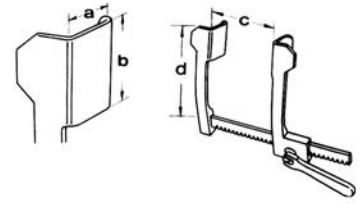

DE BAKEY

30-245-03 V1 30 x 30 mm

30-245-04 V2 40 x 40 mm

30-245-05 V3 50 x 50 mm

Valvenpaar
Pairs of valves
Pares de valvas
paia di valve

DE BAKEY

30-245-01

Sperrer allein
Spreader only
Separador solo
Divaricatore suelto

DE BAKEY

	a			b			c	d
	V1	V2	V3	V1	V2	V3		
30-245-00	30 mm	40 mm	50 mm	30 mm	40 mm	50 mm	150,0 mm	180,0 mm

STEEL
STAINLESS



für Erwachsene
 for adults
 para adultos
 per adulti

DE BAKEY

30-246-00	a			b			c	d
	V1	V2	V3	V1	V2	V3		
	60 mm	50 mm	40 mm	60 mm	80 mm	100mm	200,0 mm	185,0 mm

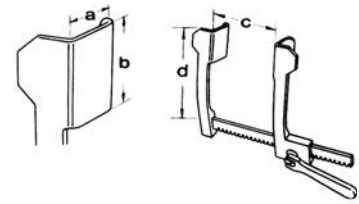

DE BAKEY

30-246-02 50 x 66 mm

Valvenpaar
 Pairs of valves
 Pares de valvas
 paia di valve



DE BAKEY

30-246-03 V1 60 x 60 mm

30-246-04 V2 50 x 80 mm

30-246-05 V3 40 x 100 mm

30-246-06 80 x 60 mm

Valvenpaar
 Pairs of valves
 Pares de valvas
 paia di valve

DE BAKEY

30-246-01

Sperrer allein
 Spreader only
 Separador solo
 Divaricatore suolto



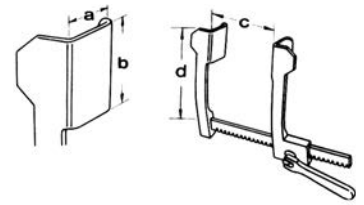

für Kinder
for children
para niños
per bambini

COOLEY

	a	b	c	d
30-247-00	20,0 mm	45,0 mm	140,0 mm	110,0 mm

STEEL
STAINLESS

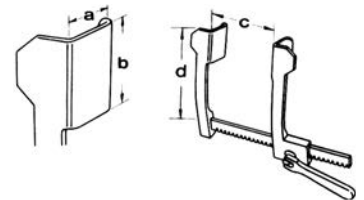

für Erwachsene
for adults
para adultos
per adulti

COOLEY

	a	b	c	d
30-248-00	30,0 mm	50,0 mm	185,0 mm	145,0 mm

STEEL
STAINLESS

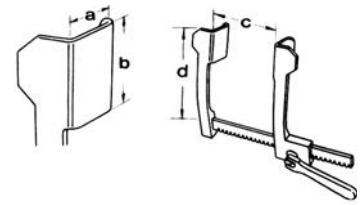

für Erwachsene
 for adults
 para adultos
 per adulti

COOLEY

STEEL
 STAINLESS

	a	b	c	d
30-249-00	35,0 mm	100,0 mm	180,0 mm	165,0 mm
30-250-00	35,0 mm	110,0 mm	230,0 mm	205,0 mm

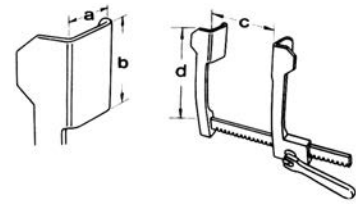

mit 2 Paar Valven (V1 | V2)
with 2 pairs of valves (V1 | V2)
con 2 pares de valvas (V1 | V2)
con 2 paia de valve (V1 | V2)



MERCEDES

30-251-02 V1 42 x 65 mm

30-251-03 V1 75 x 75 mm

Valvenpaar
Pair of valves
Pares de valvas
paia di valve

MERCEDES

30-251-01

Sperrer allein
Spreader only
Separador solo
Divaricatore suelto

MERCEDES



	V1	a	V2	V1	b	V2	c	d
30-251-00	42,0 mm		75,0 mm	65,0 mm		75,0 mm	240,0 mm	185,0 mm

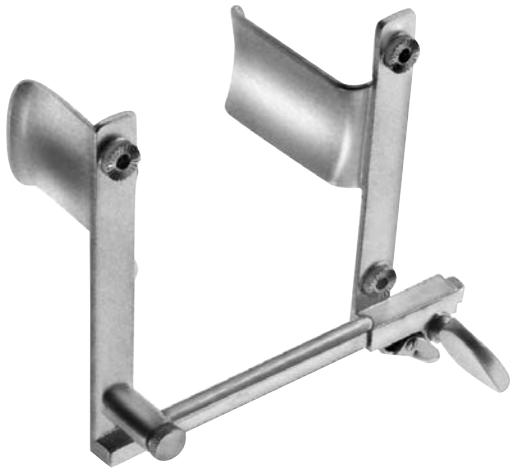
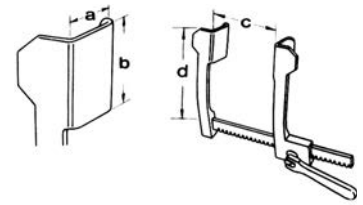

HEART-GATE

STEEL
 STAINLESS

	a	b	c	d
30-252-00	30,0 mm	60,0 mm		

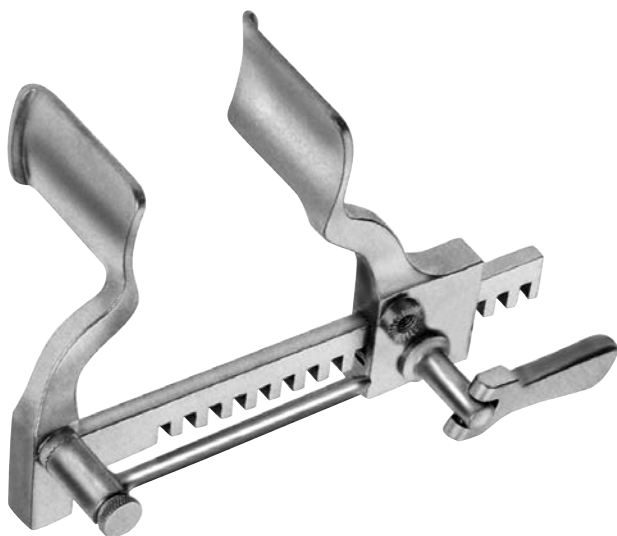
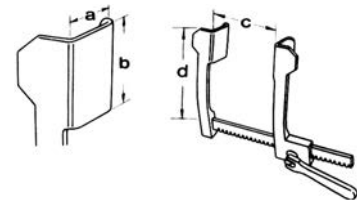

HEART-GATE

STEEL
 STAINLESS

	a	b	c	d
30-252-01	30,0 mm	60,0 mm		

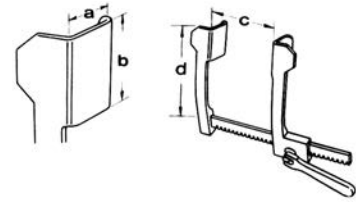

mit 2 Paar Valven (V1 | V2)
with 2 pairs of valves (V1 | V2)
con 2 pares de valvas (V1 | V2)
con 2 paia de valve (V1 | V2)



	V1	a 	V2	V1	b 	V2	c	d
30-252-02	30,0 mm		30,0 mm	40,0 mm		60,0 mm		



30-252-20 Ø 6,0 mm

Fixierklammer
Fixation clamp
Pinza de fijación
Clip di fissaggio



30-252-21 Ø 6,0 mm

Fixierklammer
Fixation clamp
Pinza de fijación
Clip di fissaggio

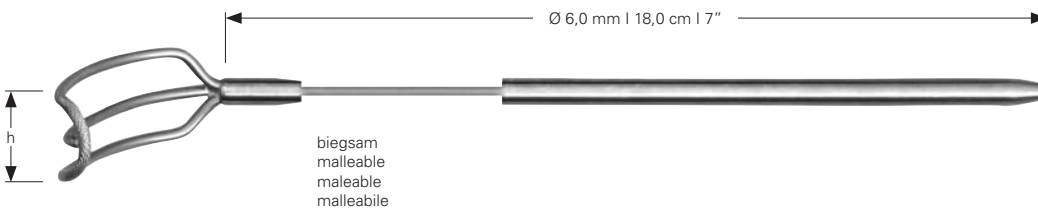

biegsam
malleable
maleable
malleabile



30-253-01	h = 20,0 mm
30-253-02	h = 35,0 mm
30-253-03	h = 45,0 mm

Atrial Haken
Atrial Retractor
Gancho auricular
Gancio atriale

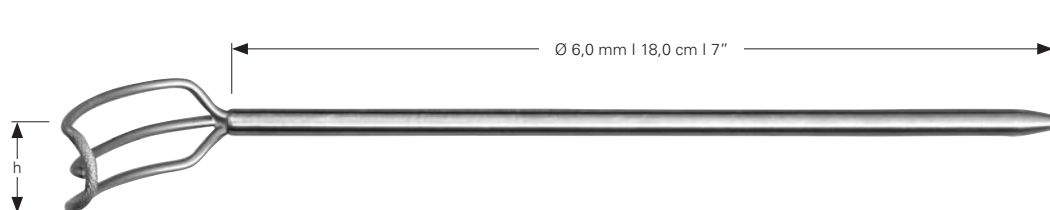

HEART-GATE

30-253-11	h = 20,0 mm
30-253-12	h = 35,0 mm
30-253-13	h = 45,0 mm ^{TRICUSPID}
30-253-14	h = 45,0 mm

Atrial Haken
 Atrial Retractor
 Gancho auricular
 Gancio atriale

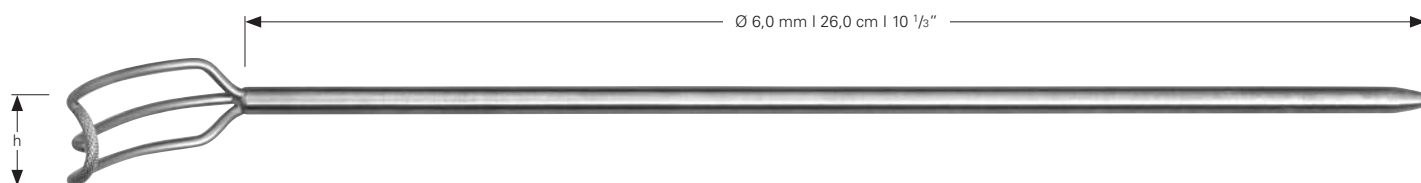

HEART-GATE

30-253-21	h = 20,0 mm
30-253-22	h = 35,0 mm
30-253-23	h = 45,0 mm ^{TRICUSPID}
30-253-24	h = 45,0 mm

Atrial Haken
 Atrial Retractor
 Gancho auricular
 Gancio atriale

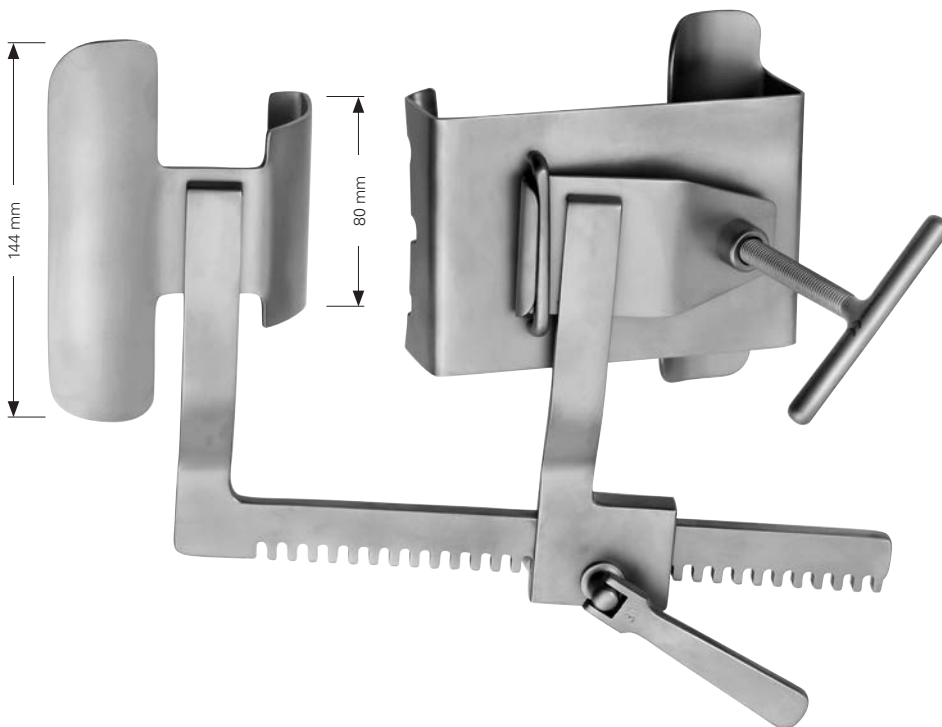
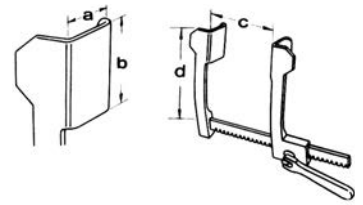

I.M.A.

30-254-02 40 x 100 mm

Mammaria Valve, allein
Mammaria valve, only
Valva mamaria, suelto
Valva mammaria, solo

I.M.A.

30-254-01

Sperrer, allein
Spreader, only
Separador, suelto
Divaricatore, solo

I.M.A.

	a	b	c	d
30-254-00	40,0 mm	100,0 mm	134,0 mm	195,0 mm

STEEL
STAINLESS

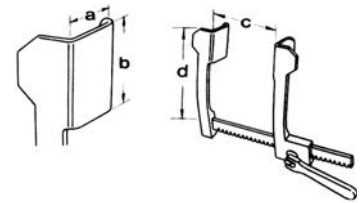

I.M.A.

30-254-12 V1 30 x 50 mm

Mammaria Valve, komplett links und rechts
Mammaria valve, complete left and right
Valva mamaria, completo izquierda y derecha
Valva Mammaria, completo sinistra e destra



I.M.A.

30-254-13 V2 30 x 100 mm

30-254-14 V3 40 x 100 mm

Sternumvalven, paar
Sternum valves, pair
Sternum valca, pareja
Sternum valve, coppia

I.M.A.

30-254-11

Sperrer, allein
Spreader, only
Separador, suelto
Divaricatore, solo

I.M.A.



	a			b			c	d
	V1	V2	V3	V1	V2	V3		
30-254-10	30 mm	30 mm	40 mm	50 mm	100 mm	100mm	215,0 mm	140,0 mm

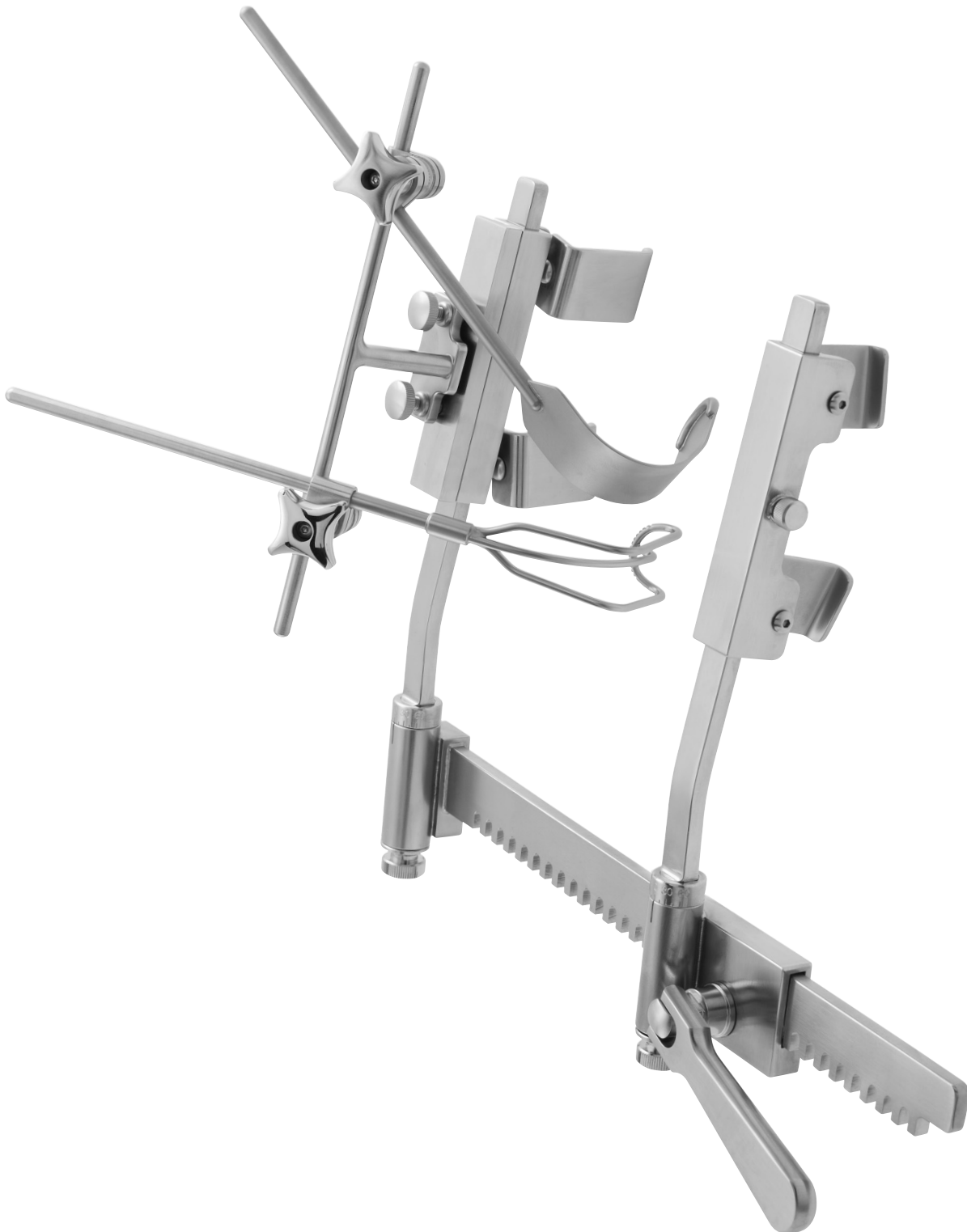
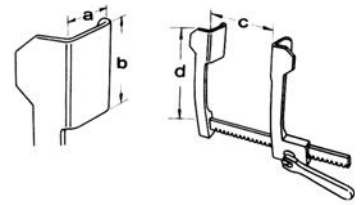

I.M.A.

	a	b	c	d
30-254-20	30,0 mm	27,0 mm	230,0 mm	205,0 mm

STEEL
STAINLESS



COOLEY

30-254-30 25 x 35 mm

30-254-31 40 x 35 mm

30-254-32 50 x 35 mm

Wundhaken
Retractors
Separadores
Divaricatori



RIBBON

30-254-33 30 x 27 mm

Wundhaken, biegsam
Retractors, malleable
Separadores, maleable
Divaricatori, malleabile

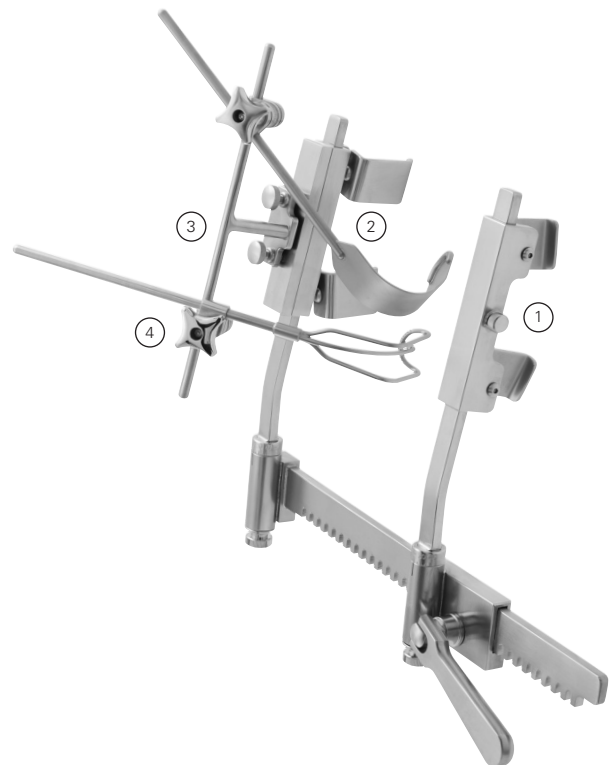

I.M.A.

30-254-20 SET

I.M.A. Sperrer komplett,
bestehend aus:

1 Sperrer	30-254-21
1 Doppelaufsteckvalve	30-254-22
1 Doppelaufsteckvalve	30-254-23
1 T - Gestell	30-254-24
2 Universalklemme	30-254-25
2 Retraktor, 25 mm	30-254-30
1 Retraktor, 40 mm	30-254-31
1 Retraktor, 50 mm	30-254-32
2 Retraktor, 25 mm	30-254-33

I.M.A. spreader complete,
consisting of:

1 Spreader	30-254-21
1 Double fixation valve	30-254-22
1 Double fixation valve	30-254-23
1 T - rack	30-254-24
2 Universal clamp	30-254-25
2 Retractor, 25 mm	30-254-30
1 Retractor, 40 mm	30-254-31
1 Retractor, 50 mm	30-254-32
2 Retractor, 25 mm	30-254-33

Separador I.M.A., completo,
compuesto de:

1 Separador	30-254-21
1 Valva de doble inserción	30-254-22
1 Valva de doble inserción	30-254-23
1 Bastidor en T	30-254-24
2 Pinza universal	30-254-25
2 Separador, 25 mm	30-254-30
1 Separador, 40 mm	30-254-31
1 Separador, 50 mm	30-254-32
2 Separador, 25 mm	30-254-33

Divaricatori I.M.A., completo,
composto da:

1 Divaricatori	30-254-21
1 Valvola di fissaggio	30-254-22
1 Valvola di fissaggio	30-254-23
1 Telaio a T	30-254-24
2 Morsetto universale	30-254-25
2 Divaricatori, 25 mm	30-254-30
1 Divaricatori, 40 mm	30-254-31
1 Divaricatori, 50 mm	30-254-32
2 Divaricatori, 25 mm	30-254-33

I.M.A.

④

30-254-25

Universalklemme mit Zahnung
Universal clamp with teeth
Pinza universal con dentado
Morsetto universale con dentellatura

I.M.A.

③

30-254-24

T - Gestell
T - rack
Bastidor en T
Telaio a T

I.M.A.

②

30-254-23 30 x 27 mm

Doppelaufsteckvalve für T - Gestell
Double fixation valve for T - rack
Valva de doble inserción para bastidor en T
Valvola di fissaggio doppia per telaio a T

I.M.A.

①

30-254-22 30 x 27 mm

Doppelaufsteckvalve
Double fixation valve
Valva de doble inserción
Valvola di fissaggio doppia

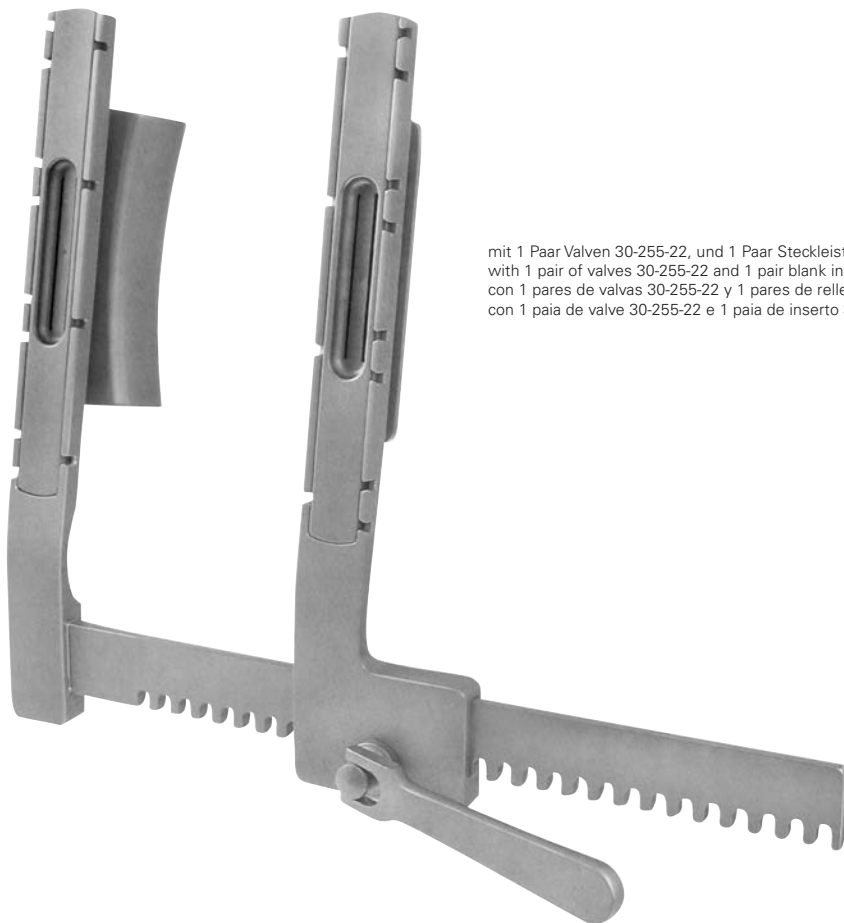
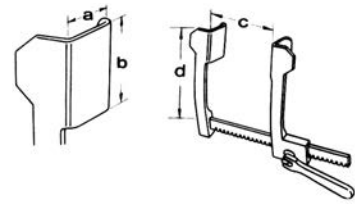

mit 1 Paar Valven 30-255-22, und 1 Paar Steckleisten 30-255-10
 with 1 pair of valves 30-255-22 and 1 pair blank inserts 30-255-10
 con 1 pares de valvas 30-255-22 y 1 pares de rellenos 30-255-10
 con 1 paio de valve 30-255-22 e 1 paio de inserto 30-255-10

CARDIOBASE

STEEL
 STAINLESS

	a	b	c	d
30-255-00	30,0 mm	100,0 mm	190,0 mm	190,0 mm

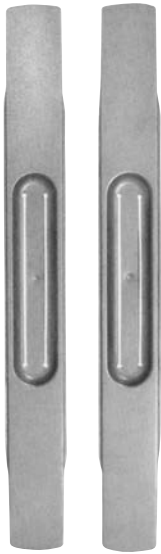

CARDIOBASE

30-255-10

Steckleistenpaar
 Pair blank inserts
 Pares de rellenos
 Paia de inserto

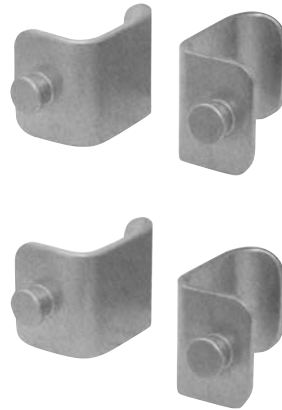

MORSE

30-255-20 30 x 28 mm

30-255-21 40 x 28 mm

2 Paar Valven
 2 pairs of valves
 2 pares de valvas
 2 paia de valve

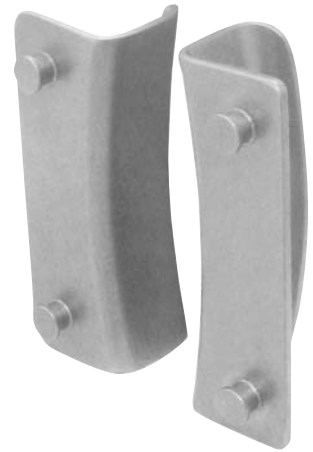

COOLEY

30-255-22 30 x 100 mm

30-255-23 40 x 100 mm

Valvenpaar
 Pair of valves
 Pares de valvas
 paia di valve



Verpackungseinheit: 3 St.
 Packing unit: 3 pieces
 Unidad: 3 piezas
 Confezione: 3 pezzi



CARDIOBASE

30-255-30

Retraktorhalterung
 Retractor holder
 Soporte de seperador
 Supporto di divaricatori



CARDIOBASE

30-255-31 55 x 18 mm

30-255-32 80 x 18 mm

30-255-33 80 x 22 mm

Retraktor
 Retractor
 Seperador
 Divaricatori



BAILEY-GIBBON

30-262-14 16,0 cm, 6 ¼"



für Kinder
for children
para niños
per bambini

BAILEY-GIBBON

30-263-16 18,0 cm, 7"



für Erwachsene
for adults
para adultos
per adulti

BAILEY-GIBBON

30-264-16 18,0 cm, 7"



SELLORS

30-265-19 19,0 cm, 7 ½"



ALLISON

30-301-26 26,0 cm, 10 ¼"
30-301-32 32,0 cm, 12 ½"



30-301-26 40,0 mm
30-301-32 65,0 mm



30-302-26 132,0 mm

ALLISON

30-302-26 26,0 cm, 10 1/4"

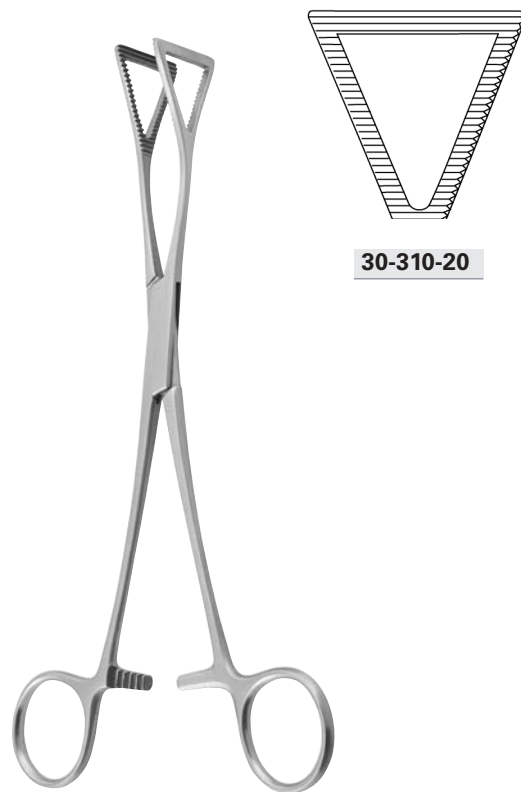

30-310-20

LOVELACE

30-310-20 20,0 cm, 8"

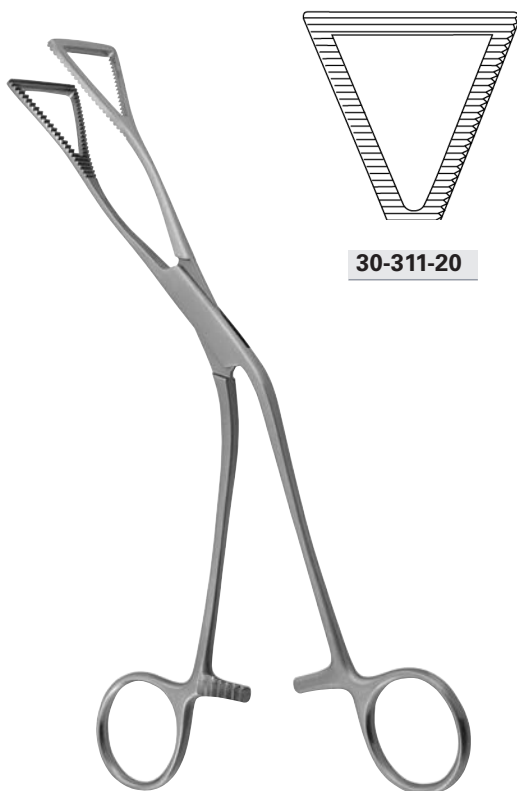

30-311-20

LOVELACE

30-311-20 20,0 cm, 8"



30-313-22

PRINCE-THOMAS

30-313-22 22,0 cm, 8 3/4"

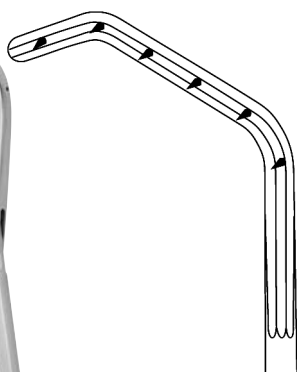
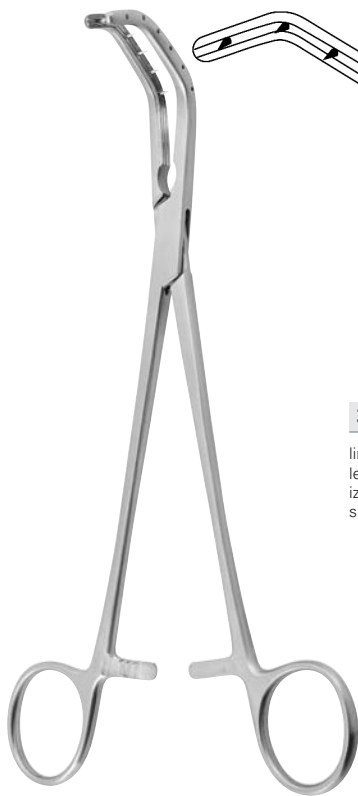

30-315-22

links
left
izquierda
sinistra

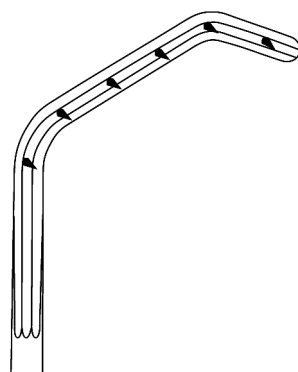

30-317-22

rechts
right
derecha
destra

PRINCE-THOMAS

30-315-22 - 30-317-22 22,0 cm, 8 3/4"



30-325-23

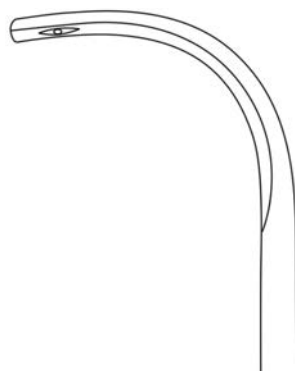

30-327-23

SEMB

30-325-23 - 30-327-23 24,0 cm, 9 1/2"



31



Herz- und Gefäßchirurgie

Cardiovascular Surgery

Cirurgía cardiovascular

Chirurgia cardiovascolare



31



Mikro Instrumente

Micro Instruments

Instrumentos de micro

Strumentario micro

Fordern Sie unser Spezialprospekt an
Please ask for our special catalogue
No duden pedirnos más catálogos especiales
Chiedete i nostri cataloghi speciali



NABATOFF

31-010-00 SET

Komplett, bestehend aus:

1 Zugseil	31-010-01
1 Kunststoffspitze	31-010-02
1 Sondenspitze, Ø 3 mm	31-010-03
1 Olive, Ø 6 mm	31-010-04
1 Olive, Ø 9 mm	31-010-05
1 Olive, Ø 12 mm	31-010-06
1 Olive, Ø 15 mm	31-010-07
1 T-Griff	31-010-08
1 Metalletui	31-010-09

Complete, consisting of:

1 Traction cable	31-010-01
1 Plastic probe tip	31-010-02
1 Probe Tip, Ø 3 mm	31-010-03
1 Olive, Ø 6 mm	31-010-04
1 Olive, Ø 9 mm	31-010-05
1 Olive, Ø 12 mm	31-010-06
1 Olive, Ø 15 mm	31-010-07
1 T-Handle	31-010-08
1 Metal case	31-010-09

Completo, compuesto de:

1 Cable de tracción	31-010-01
1 Punta plástica	31-010-02
1 Punta metálica, Ø 3 mm	31-010-03
1 Oliva, Ø 6 mm	31-010-04
1 Oliva, Ø 9 mm	31-010-05
1 Oliva, Ø 12 mm	31-010-06
1 Oliva, Ø 15 mm	31-010-07
1 Mango, forma T	31-010-08
1 Caja metálica	31-010-09

Completo, composto da:

1 Fune di trazione	31-010-01
1 Punta di plastica	31-010-02
1 Punta metallica, Ø 3 mm	31-010-03
1 Oliva, Ø 6 mm	31-010-04
1 Oliva, Ø 9 mm	31-010-05
1 Oliva, Ø 12 mm	31-010-06
1 Oliva, Ø 15 mm	31-010-07
1 Mango, forma T	31-010-08
1 Scatola metallica	31-010-09



NABATOFF

31-010-04	Ø 6,0 mm
31-010-05	Ø 9,0 mm
31-010-06	Ø 12,0 mm
31-010-07	Ø 15,0 mm

Olive
Olive
Oliva
Oliva



NABATOFF

31-010-01 90,0 cm, 35 1/2"

Zugseil
Traction cable
Cable de tracción
Fune di trazione



NABATOFF

31-010-02

Kunststoffspitze
Plastic probe tip
Punta plástica
Punta di plastica



NABATOFF

31-010-03 Ø 3,0 mm

Sondenspitze Metall
Plastic probe tip
Punta metálica
Punta metallica



NABATOFF

31-010-08

T-Griff
T-Handle
Mango, forma T
Mango, forma T



VARADY

31-011-00 SET

Komplett, bestehend aus:	Complete, consisting of:
1 Zugseil 31-011-01	1 Traction cable 31-011-01
1 Olive, Ø 3 mm 31-011-03	1 Olive, Ø 3 mm 31-011-03
1 Olive, Ø 4 mm 31-011-04	1 Olive, Ø 4 mm 31-011-04
1 Olive, Ø 5 mm 31-011-05	1 Olive, Ø 5 mm 31-011-05
1 Metalletui 31-011-09	1 Metal case 31-011-09

Completo, compuesto de:	Completo, composto da:
1 Cable de tracción 31-011-01	1 Fune di trazione 31-011-01
1 Oliva, Ø 3 mm 31-011-03	1 Oliva, Ø 3 mm 31-011-03
1 Oliva, Ø 4 mm 31-011-04	1 Oliva, Ø 4 mm 31-011-04
1 Oliva, Ø 5 mm 31-011-05	1 Oliva, Ø 5 mm 31-011-05
1 Caja metálica 31-011-09	1 Scatola metallica 31-011-09



VARADY

31-011-01 45,0 cm, 17³/₄"

Zugseil
 Traction cable
 Cable de tracción
 Fune di trazione

VARADY

31-011-03	Ø 3,0 mm
31-011-04	Ø 4,0 mm
31-011-05	Ø 5,0 mm

Olive
 Olive
 Oliva
 Oliva



31-013-02	Ø 2,0 mm
31-013-03	Ø 3,0 mm
31-013-04	Ø 4,0 mm
31-013-06	Ø 6,0 mm
31-013-07	Ø 7,0 mm
31-013-08	Ø 8,5 mm
31-013-10	Ø 10,0 mm
31-013-12	Ø 12,0 mm
31-013-14	Ø 14,0 mm

VOLLMAR

31-013-02 - 31-013-14 50,0 cm, 19 3/4"



31-014-02	Ø 2,0 mm
31-014-03	Ø 3,0 mm
31-014-04	Ø 4,0 mm
31-014-05	Ø 5,0 mm
31-014-06	Ø 6,0 mm
31-014-07	Ø 7,0 mm
31-014-08	Ø 8,0 mm
31-014-09	Ø 9,0 mm
31-014-10	Ø 10,0 mm
31-014-12	Ø 12,0 mm
31-014-14	Ø 14,0 mm

VOLLMAR

31-014-02 - 31-014-14 50,0 cm, 19 3/4"



VOLLMAR

31-012-00 11,0 cm, 4 3/8"

Ø 0,5 mm	Ø 1,0 mm	Ø 1,5 mm	Ø 2,0 mm	Ø 2,5 mm	Ø 3,0 mm	Ø 4,0 mm
31-015-05	31-015-10	31-015-15	31-015-20	31-015-25	31-015-30	31-015-40
31-016-05	31-016-10	31-016-15	31-016-20	31-016-25	31-016-30	31-016-40
31-017-05	31-017-10	31-017-15	31-017-20	31-017-25	31-017-30	31-017-40

Ø 5,0 mm

31-015-50
31-016-50
31-017-50

biegsam
malleable
maleable
malleabile

Aluminium Handgriff, biegsam
Aluminium handle, malleable
Manija del aluminio, maleable
Maniglia dell'aluminio, malleabile















COOLEY

31-015-05 - 31-015-50 13,0 cm, 5 1/8"

COOLEY

31-016-05 - 31-016-50 15,0 cm, 6"
31-017-05 - 31-017-50 20,0 cm, 8"













 Ø 0,5 mm	 Ø 1,0 mm	 Ø 1,5 mm	 Ø 2,0 mm	 Ø 2,5 mm	 Ø 3,0 mm
31-018-05 31-019-05	31-018-10 31-019-10	31-018-15 31-019-15	31-018-20 31-019-20	31-018-25 31-019-25	31-018-30 31-019-30
 Ø 3,5 mm	 Ø 4,0 mm	 Ø 4,5 mm	 Ø 5,0 mm	 Ø 7,0 mm	 Ø 9,0 mm
31-018-35 31-019-35	31-018-40 31-019-40	31-018-45 31-019-45	31-018-50 31-019-50	31-018-70 31-019-70	31-018-90 31-019-90

biegsam
 malleable
 maleable
 malleabile

DE BAKEY

31-018-05 - 31-018-90 19,0 cm, 7 ½"
31-019-05 - 31-019-90 35,0 cm, 13¾"



 Ø 0,5 mm	 Ø 1,0 mm	 Ø 1,5 mm	 Ø 2,0 mm	 Ø 2,5 mm
31-020-05 31-021-05	31-020-10 31-021-10	31-020-15 31-021-15	31-020-20 31-021-20	31-020-25 31-021-25
 Ø 3,0 mm	 Ø 3,5 mm	 Ø 4,0 mm	 Ø 4,5 mm	 Ø 5,0 mm
31-020-30 31-021-30	31-020-35 31-021-35	31-020-40 31-021-40	31-020-45 31-021-45	31-020-50 31-021-50

biegsam
 malleable
 maleable
 malleabile

GARRETT

31-020-05 - 31-020-50 14,0 cm, 5 ½"
31-021-05 - 31-021-50 21,0 cm, 8 ¼"

GARRETT SET

31-020-00 14,0 cm, 5 ½"

Set 31-020-05 - 31-020-50

GARRETT SET

31-021-00 21,0 cm, 8 ¼"

Set 31-021-05 - 31-021-50

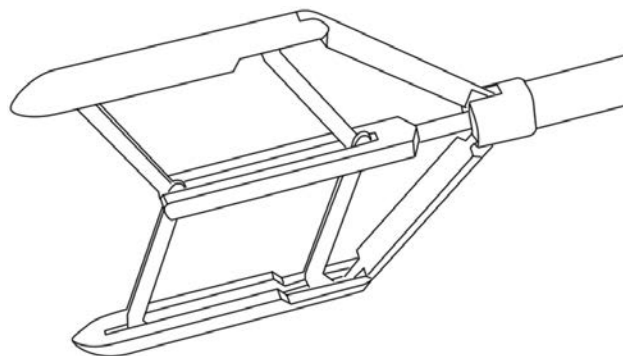

Spreizweite 8,0 - 42,0 mm
blade opening 8,0 - 42,0 mm
abertura 8,0 - 42,0 mm
apertura 8,0 - 42,0 mm

TUBBS

31-030-00 8,0 - 42,0 mm

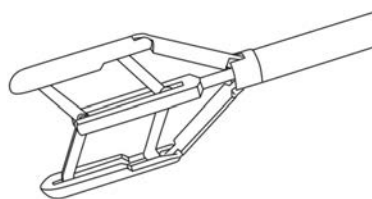

Spreizweite 8,0 - 15,0 mm
blade opening 8,0 - 15,0 mm
abertura 8,0 - 15,0 mm
apertura 8,0 - 15,0 mm

für Kinder
for children
para niños
per bambini

COOLEY

31-032-00 8,0 - 15,0 mm



zerlegbar
 detachable
 desmontable
 smontabile

31-034-02	Ø 2,0 mm
31-034-03	Ø 3,0 mm
31-034-04	Ø 4,5 mm
31-034-05	Ø 5,0 mm
31-034-06	Ø 6,0 mm

31-035-02	Ø 2,0 mm
31-035-03	Ø 3,0 mm
31-035-04	Ø 4,5 mm
31-035-05	Ø 5,0 mm
31-035-06	Ø 6,0 mm

31-036-02	Ø 2,0 mm
31-036-03	Ø 3,0 mm
31-036-04	Ø 4,5 mm
31-036-05	Ø 5,0 mm
31-036-06	Ø 6,0 mm

31-037-02	Ø 2,0 mm
31-037-03	Ø 3,0 mm
31-037-04	Ø 4,5 mm
31-037-05	Ø 5,0 mm
31-037-06	Ø 6,0 mm

31-038-02	Ø 2,0 mm
31-038-03	Ø 3,0 mm
31-038-04	Ø 4,5 mm
31-038-05	Ø 5,0 mm
31-038-06	Ø 6,0 mm

31-034-02 - 31-034-06	12,0 cm, 4 ¾ "
31-035-02 - 31-035-06	15,0 cm, 6 "
31-036-02 - 31-036-06	18,0 cm, 7 "
31-037-02 - 31-037-06	20,0 cm, 8 "
31-038-02 - 31-038-06	25,0 cm, 9 ¾ "

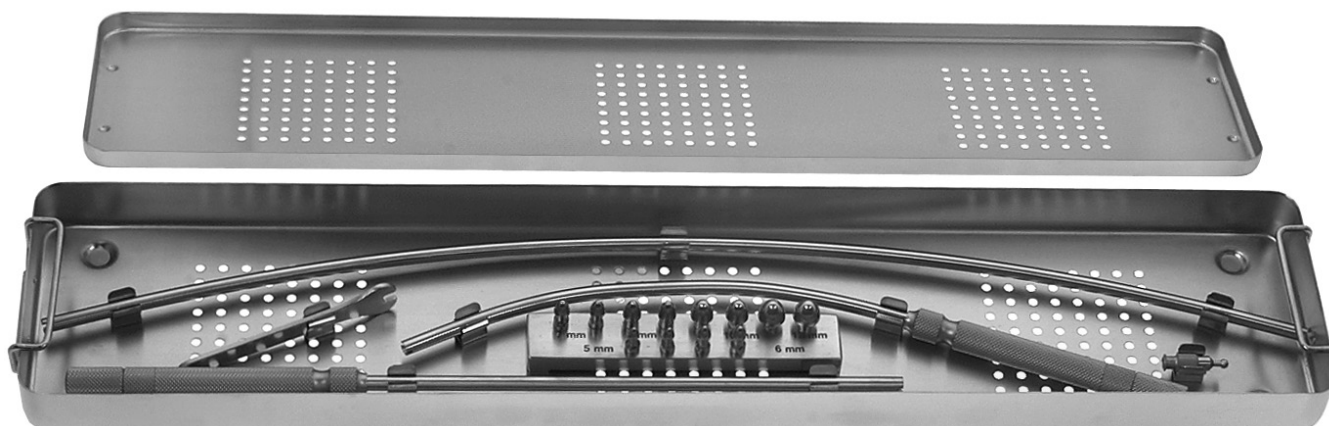

SET

31-040-00

Satz komplett mit 3 Schäften, 2 Griffen und 12 Aufsätzen im Lagerungsbehälter
 Set complete with 3 shafts, 2 handles and 12 tips in storage case
 Juego completo con 3 vástagos, 2 mangos y 12 cabezas en caja metálica
 Set completo, con 3 gambi, 2 mancini e 12 raccordi in contenitore metallico

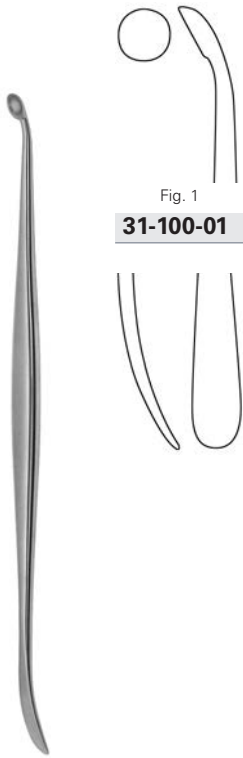

Fig. 1
31-100-01

PENFIELD

31-100-01 17,5 cm, 7"

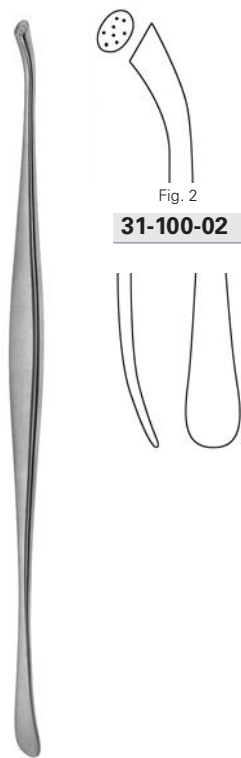

Fig. 2
31-100-02

PENFIELD

31-100-02 19,5 cm, 7 3/4"

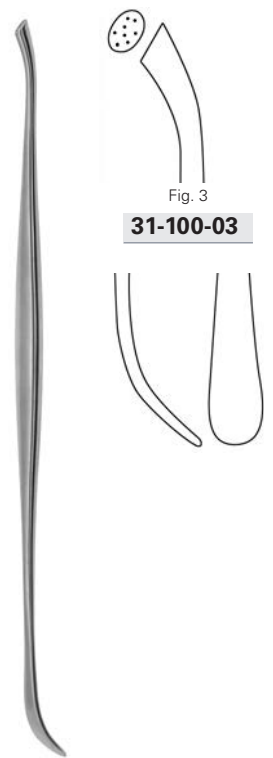

Fig. 3
31-100-03

PENFIELD

31-100-03 19,5 cm, 7 3/4"



Fig. 4
31-100-04

PENFIELD

31-100-04 20,5 cm, 8"

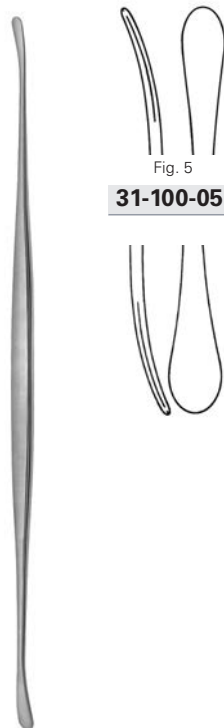
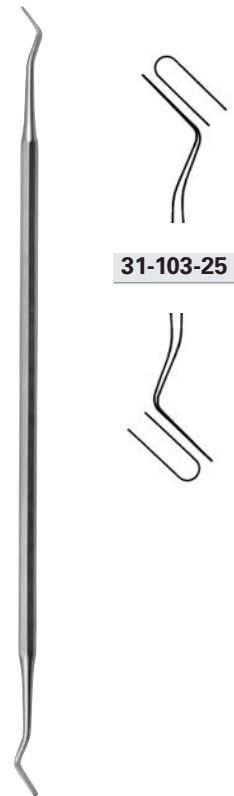

Fig. 5
31-100-05

PENFIELD

31-100-05 18,5 cm, 7 1/4"



31-103-25

WOODSON

31-103-25 25,0 cm, 9 3/4"

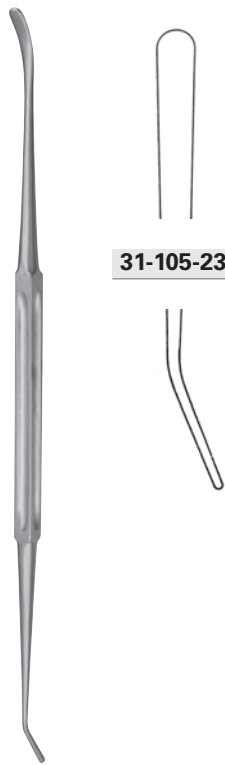

31-105-23



31-107-18
31-107-21

stumpf
 blunt
 romo
 smusso



31-107-18T

stumpf
 blunt
 romo
 smusso



PENNYBACKER

31-105-23 23,0 cm, 9"

31-107-18 18,5 cm, 7 1/4"

31-107-21 21,5 cm, 8 1/2"

31-107-18 T 18,5 cm, 7 1/4"



31-108-14

stumpf
 blunt
 romo
 smusso



31-108-23

stumpf
 blunt
 romo
 smusso



31-109-24



31-110-14

5,0 mm

31-110-24

7,0 mm

31-108-14 14,0 cm, 5 1/2"

31-108-23 23,5 cm, 9 1/4"

DAVIS

31-109-24 24,5 cm, 9 2/3"

SCHMID

31-110-14 14,0 cm, 5 1/2"

31-110-24 24,0 cm, 9 1/2"

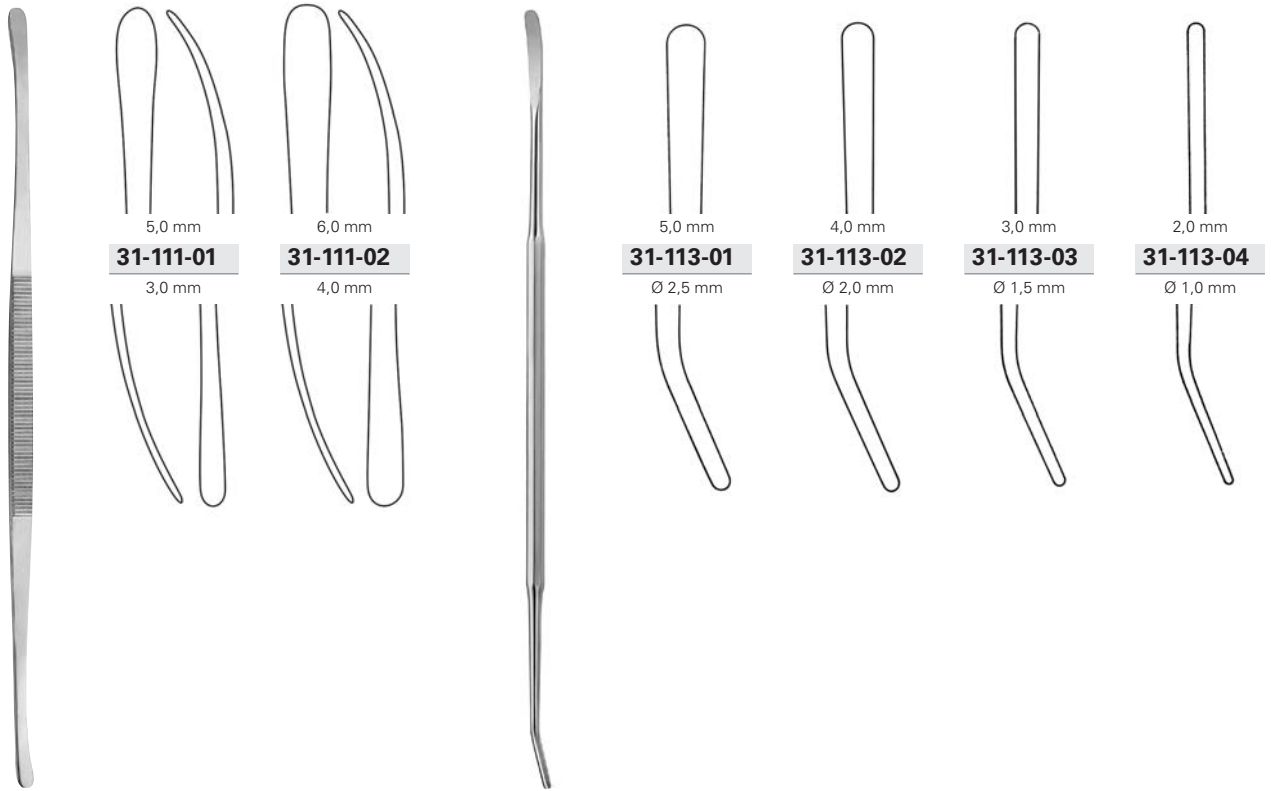

TOENNIS

31-111-01 - 31-111-02 24,0 cm, 9 ½"

ROBB

31-113-01 - 31-113-04 24,0 cm, 9 ½"

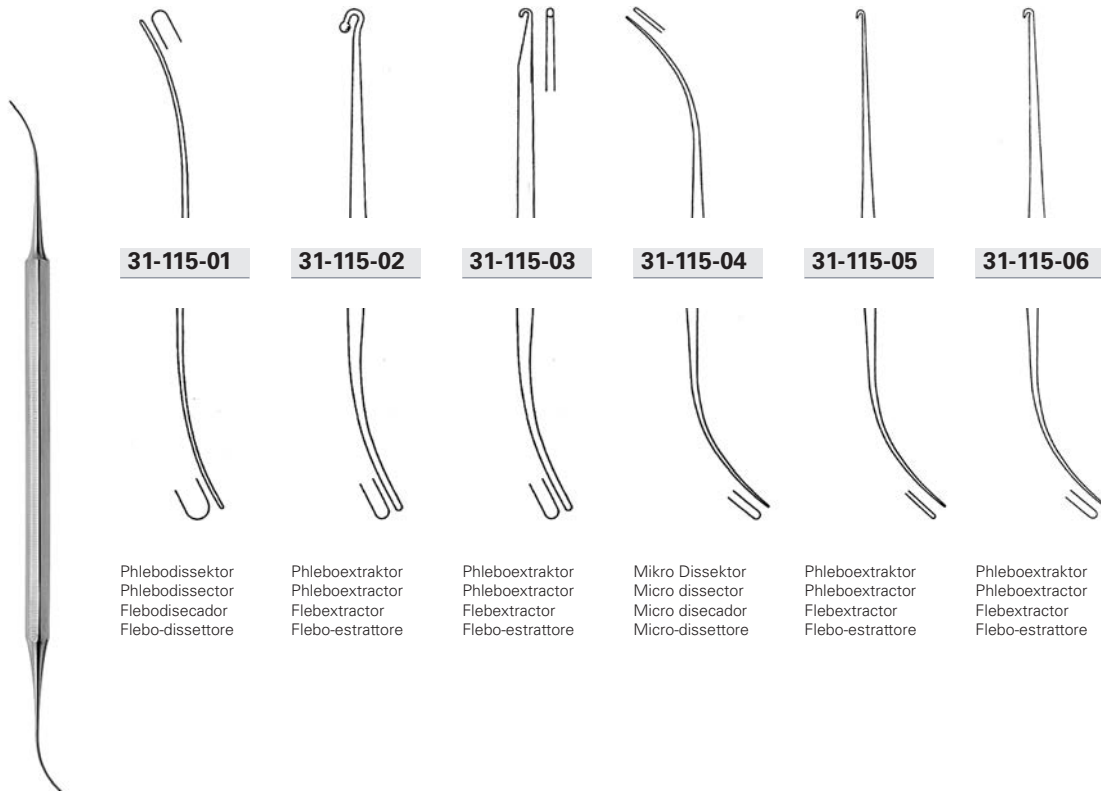

VARADY

31-115-01 - 31-115-06 18,0 cm, 7"



Ø 3,2 mm
31-130-32

Ø 6,4 mm
31-130-64



2,0 mm
31-132-20

2,5 mm
31-132-25

3,0 mm
31-132-30

RUMEL-BELMONT

31-130-32 27,0 cm, 10³/₄ "
31-130-64 30,5 cm, 12 "

RUMEL-BELMONT

31-132-20 - 31-132-30 26,0 cm, 10¹/₄ "



COOLEY

COOLEY

31-200-24 26,0 cm, 10 3/4"

31-201-24 26,0 cm, 10 3/4"
31-203-24 24,0 cm, 9 1/2"
31-204-24 24,0 cm, 9 1/2"

COOLEY

31-202-25 27,5 cm, 10 3/4"

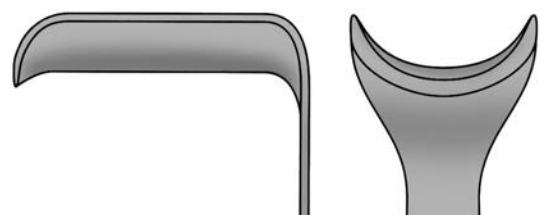
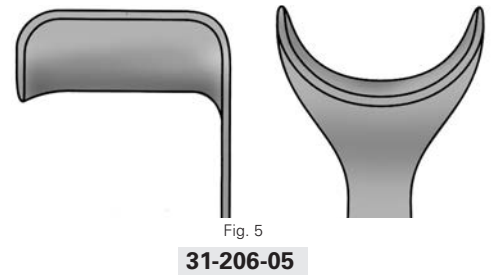
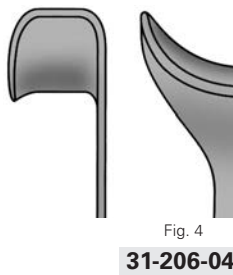
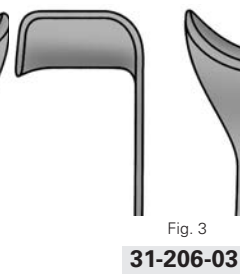
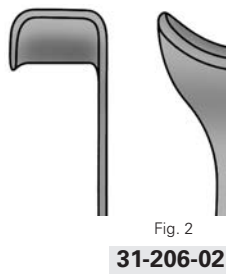
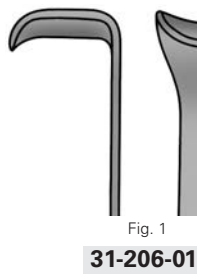

Schaft flexibel
Flexible shaft
Vástago flexible
Asta flessibile

ROSS

31-206-01 - 31-206-06 27,0 cm, 10 3/4"

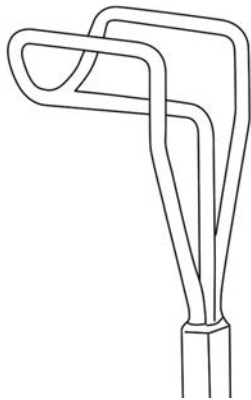

17 x 21 mm

31-208-01

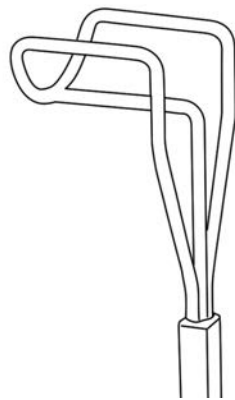

16 x 23 mm

31-208-02

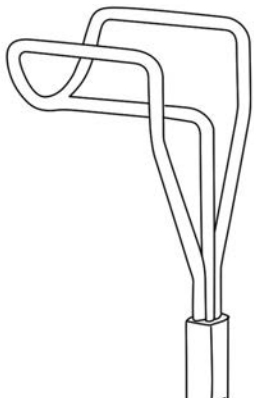

20 x 25 mm

31-208-03

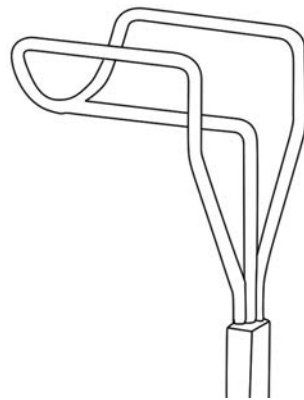

24 x 27 mm

31-208-04



Schaft flexibel
 Flexible shaft
 Vástago flexible
 Asta flessibile

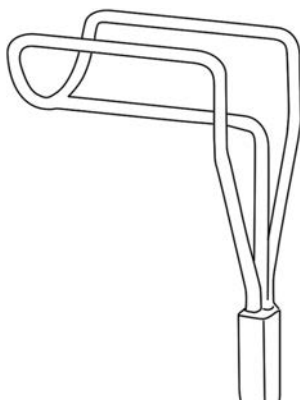

28 x 20 mm

31-208-05

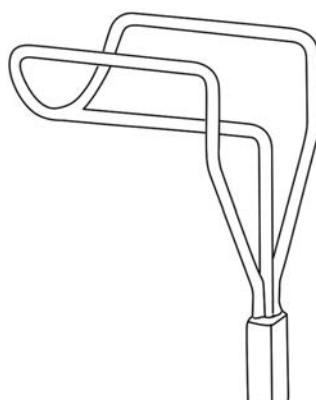

28 x 29 mm

31-208-06

Epikardial Retraktoren
 Epicardial retractors
 Retractores epicárdicos
 Divaricatori epicardici



31-210-01 25,0 mm

31-210-02 28,0 mm

31-210-03 38,0 mm

31-210-04 54,0 mm

BOROWSKI

31-208-01 - 31-208-06 27,0 cm, 10³/₄ "



31-300-01 Ø 5,0 mm

Schere, gebogen 15°
 Scissors, curved 15°
 Tijera, curva 15°
 Forbici, curva 15°

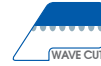
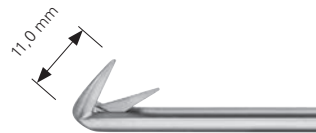

31-300-01 W Ø 5,0 mm

Schere, gebogen 15°
 Scissors, curved 15°
 Tijera, curva 15°
 Forbici, curva 15°

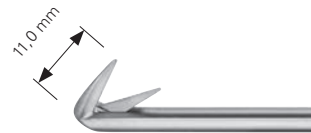

31-300-02 Ø 5,0 mm

Schere, gebogen 30°
 Scissors, curved 30°
 Tijera, curva 30°
 Forbici, curva 30°



31-301-01 Ø 3,5 mm

Mikroschere, aufgebogen 45°
 Micro Scissors, curved up 45°
 Micro-tijera, curva hacia arriba 45°
 Micro-forbici, curva verso l'alto 45°

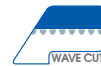

31-301-01 W Ø 3,5 mm

Mikroschere, aufgebogen 45°
 Micro Scissors, curved up 45°
 Micro-tijera, curva hacia arriba 45°
 Micro-forbici, curva verso l'alto 45°



31-301-02 Ø 3,5 mm

Mikroschere, aufgebogen 125°
 Micro Scissors, curved up 125°
 Micro-tijera, curva hacia arriba 125°
 Micro-forbici, curva verso l'alto 125°



2,8 mm



31-302-03 Ø 5,0 mm

Nadelhalter, gerade, mit Sperre
 Needle holder, straight, with ratchet
 Porta-aguja, recta, con cremallera
 Portaghi, retta, con cremagliera



31-303-01 Ø 5,0 mm

Faßzange, gerade
 Grasping forceps, straight
 Pinzas para agarrar, recta
 Pinze da presa, retta



31-303-02 Ø 5,0 mm

De Bakey Faßzange fein, gerade
 De Bakey grasping forceps, fine, straight
 De Bakey Pinzas para agarrar, fino, recta
 De Bakey Pinze da presa, fino, retta



mit Spülanschluss zur Innenreinigung des Schaftes, Aluminium Handgriff
 with connection to clean and rinse the shaft, Aluminium handle
 con conexión de irrigación para limpiar el tubo interior, Manija del aluminio
 con attacco per la pulizia interna dell'asta, Maniglia dell'aluminio



31-300-01 - 31-314-02 36,0 cm, 14 3/4 "



31-300-02 W Ø 5,0 mm

Schere, gebogen 30°
 Scissors, curved 30°
 Tijera, curva 30°
 Forbici, curva 30°

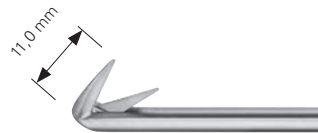

31-301-02 W Ø 3,5 mm

Mikroschere, aufgebogen 125°
 Micro Scissors, curved up 125°
 Micro-tijera, curva hacia arriba 125°
 Micro-forbici, curva verso l'alto 125°



1,5 x 15,0 mm



31-303-03 Ø 3,5 mm

De Bakey Faßzange, fein, aufgebogen
 De Bakey Grasping forceps, fine, curved up
 De Bakey Pinzas para agarrar, fino, curva hacia arriba
 De Bakey Pinze da presa, fino, curva verso l'alto



31-300-03 Ø 5,0 mm

Schere, gebogen 70°
 Scissors, curved 70°
 Tijera, curva 70°
 Forbici, curva 70°



31-302-01 Ø 5,0 mm

Nadelhalter, gerade, mit Sperre
 Needle holder, straight, with ratchet
 Porta-aguja, recta, con cremallera
 Portaghi, retta, con cremagliera



3,0 x 14,5 mm



31-303-04 Ø 5,0 mm

Resano Faßzange, gerade
 Resano grasping forceps, straight
 Resano Pinzas para agarrar, recta
 Resano Pinze da presa, retta



31-300-03 W Ø 5,0 mm

Schere, gebogen 70°
 Scissors, curved 70°
 Tijera, curva 70°
 Forbici, curva 70°



31-302-02 Ø 5,0 mm

Nadelhalter, gebogen, mit Sperre
 Needle holder, curved, with ratchet
 Porta-aguja, curva, con cremallera
 Portaghi, curva, con cremagliera



31-304-01 Ø 5,0 mm

Knotenschieber, aufgebogen
 Knot pusher, curved up
 Desplazador del nudo, curva hacia arriba
 Chiavistello del nodo, curva verso l'alto



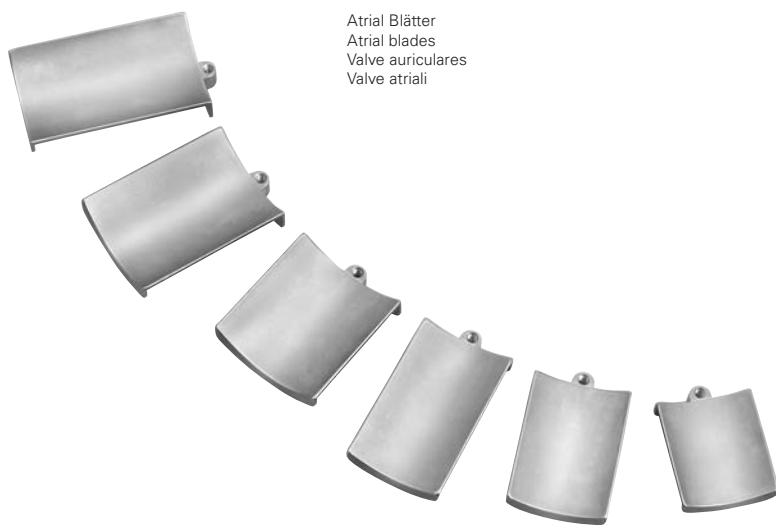

Atrial Blätter
Atrial blades
Valve auriculares
Valve atriali



Atrial Blatthalter
Atrial blades holders
Soportes de valve auriculares
Supporto valve atriali



31-310-01	40 x 35 mm
31-310-02	50 x 35 mm
31-310-03	60 x 35 mm
31-310-04	50 x 40 mm
31-310-05	60 x 40 mm
31-310-06	70 x 40 mm



31-310-10	16,0 cm, 6 1/4"
31-310-11	22,0 cm, 6 3/4"

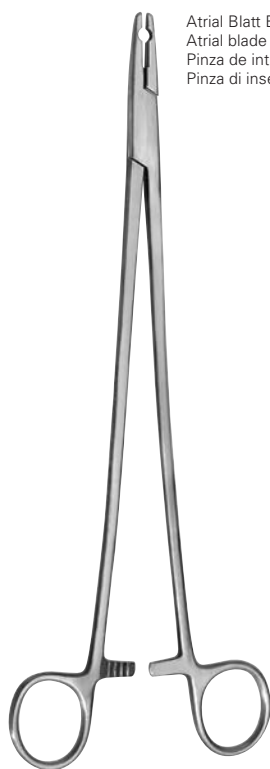

Atrial Blatt Einführungszange
Atrial blade introducer
Pinza de introducción de la lámina auricular
Pinza di inserimento valve atriali



31-310-00 SET

Komplett bestehend aus:

1 Atrial Blatt 40 x 35 mm	31-310-01
1 Atrial Blatt 50 x 35 mm	31-310-02
1 Atrial Blatt 60 x 35 mm	31-310-03
1 Atrial Blatt 50 x 40 mm	31-310-04
1 Atrial Blatt 60 x 40 mm	31-310-05
1 Atrial Blatt 70 x 40 mm	31-310-06
1 Blatthalter 16,0 cm	31-310-10
1 Blatthalter 22,0 cm	31-310-11
1 Einführungszange	31-310-20

Complete consisting of:

1 Atrial blade 40 x 35 mm	31-310-01
1 Atrial blade 50 x 35 mm	31-310-02
1 Atrial blade 60 x 35 mm	31-310-03
1 Atrial blade 50 x 40 mm	31-310-04
1 Atrial blade 60 x 40 mm	31-310-05
1 Atrial blade 70 x 40 mm	31-310-06
1 Balde holder 16,0 cm	31-310-10
1 Balde holder 22,0 cm	31-310-11
1 Blade introducer	31-310-20

Completo compuesto de:

1 Valve auric. 40 x 35 mm	31-310-01
1 Valve auric. 50 x 35 mm	31-310-02
1 Valve auric. 60 x 35 mm	31-310-03
1 Valve auric. 50 x 40 mm	31-310-04
1 Valve auric. 60 x 40 mm	31-310-05
1 Valve auric. 70 x 40 mm	31-310-06
1 Soportes 16,0 cm	31-310-10
1 Soportes 22,0 cm	31-310-11
1 Pinza de introducción	31-310-20

Completo composto da:

1 Valve atriali 40 x 35 mm	31-310-01
1 Valve atriali 50 x 35 mm	31-310-02
1 Valve atriali 60 x 35 mm	31-310-03
1 Valve atriali 50 x 40 mm	31-310-04
1 Valve atriali 60 x 40 mm	31-310-05
1 Valve atriali 70 x 40 mm	31-310-06
1 Supporto valve 16,0 cm	31-310-10
1 Supporto valve 22,0 cm	31-310-11
1 Pinza di inserimento	31-310-20



31-310-20	27,0 cm, 10 3/4"
------------------	------------------

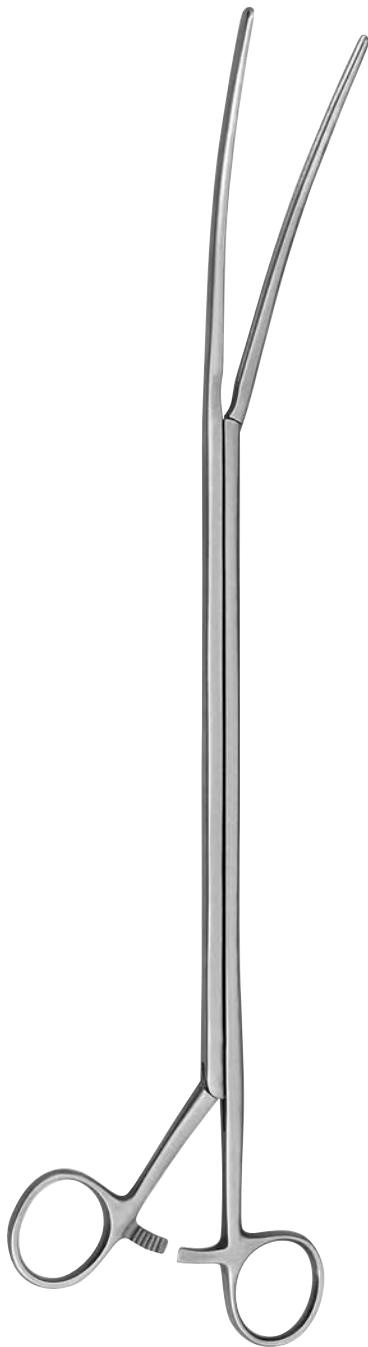

HEART-GATE 
31-311-01 35,5 cm, 14"

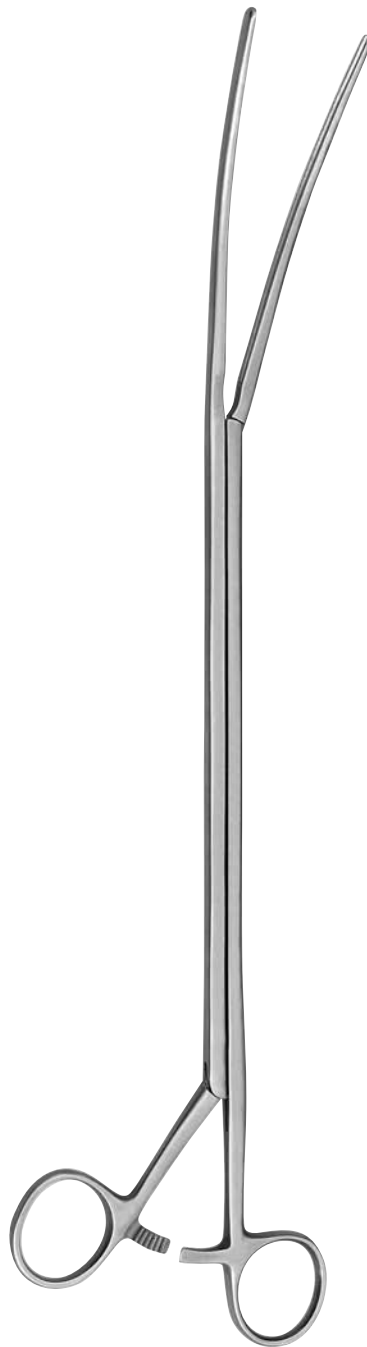

HEART-GATE 
31-311-03 32,0 cm, 12 1/4"
31-311-02 35,0 cm, 13 3/4"

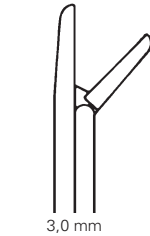

31-320-03

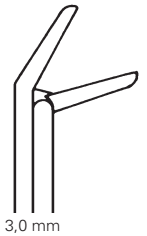

31-321-03

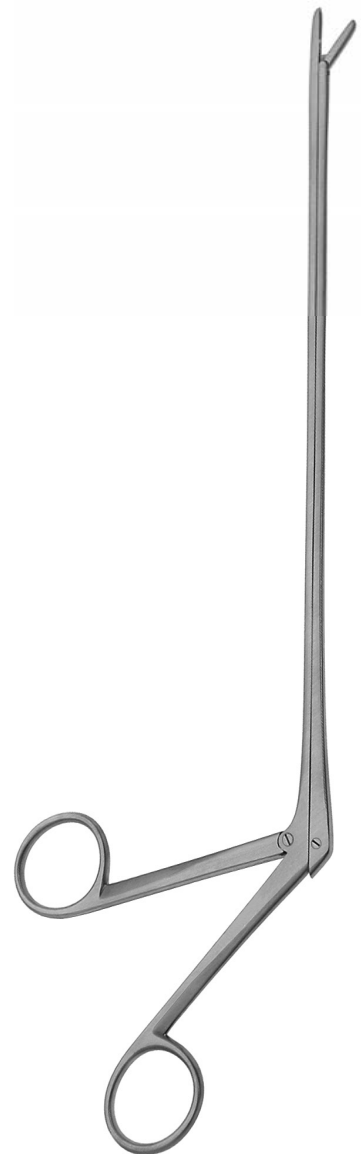

HEART-GATE
31-320-03 30,0 cm, 11 3/4"
31-321-03 30,0 cm, 11 3/4"



31-312-01



31-312-02



1,4 mm



2,0 mm

31-312-03

Nerv- und Gefäßshaken
Nerve and vessel hooks
Ganchitos para nervios y vasos
Unicini pere nervi e vasi



31-313-01



Fadenfänger
Ligature catcher
Portas ligaduras
Porta-legature



31-314-01



Magnetstab
Magnet bar
Imán de barra
Magnete di barra



31-312-01 - 31-312-03 36,0 cm, 14³/₄"



31-313-01 36,0 cm, 14³/₄"



31-314-01 36,0 cm, 14³/₄"



31-314-02

Skalpelgriff
 Scalpel handle
 Mango de bisturie
 Manici per bisturi



31-315-01

Naht Lineal
 Ligature ruler
 Regla de la sutura
 Righello del suturare



3,0 - 60,0 mm



31-316-01

31-316-02

Kardioplegie-Kanüle
 Cardioplegia needle
 Aguja del cardioplegia
 Ago della cardioplegia



Ø 2,0 mm



Ø 3,0 mm



31-314-02 36,0 cm, 14 3/4 "



31-315-01 40,0 cm, 15 3/4 "



31-316-01 - 31-316-02 31,0 cm, 12 1/4 "



flexibel
flexible
flexible
flessibile

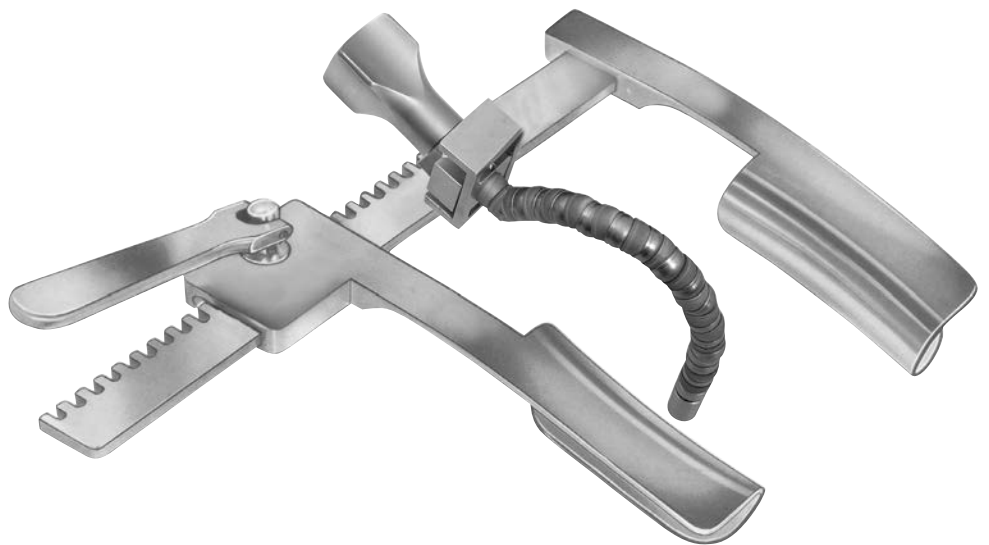

Verwendbar mit jeglichen Sternal Sperrer Systemen
Attachable to any sternal retractor systems
Conectable a cualesquiera sistema retractor externo
Adattabile a qualsiasi sistema di retrattore sternale

31-400-00 27,0 cm, 10 3/4"

Endoskope Halterung
Endoscope holding device
Equipo de endoscopia transportable
Porta endoscopio



31-410-02	Ø 2,7 mm
31-410-04	Ø 4,0 mm
31-410-05	Ø 5,0 mm
31-410-10	Ø 10,0 mm

Stabilisator Fuß
stabilizing foot
Estabilizador de pie
Piede stabilizzatore



31-411-01	30,0 mm
31-411-02	40,0 mm

Atrial Haken
Atrial Retractor
Seperador atrio
Divaricatori atrio



31-415-20	19 x 27 mm
31-415-35	29 x 27 mm
31-415-45	39 x 44 mm



31-600-12 12,0 cm, 4 $\frac{3}{8}$ "



31-602-18 18,0 cm, 7 "



31-603-10 10,0 cm, 4 "



Fig.
61-69



Fig.
61-69



Fig.
61-69



Fig.
61-69

CASPAR

31-604-13 13,0 cm, 5 $\frac{1}{8}$ "

31-606-15 15,5 cm, 6 $\frac{1}{8}$ "

31-608-18 18,0 cm, 7 "

31-610-20 20,0 cm, 8 "



Fig.
61-69

31-611-13 13,0 cm, 5 1/8"



Ti
TITANIUM
Fig.
61-69

31-611-13 T 13,5 cm, 5 1/4"



Fig.
61-69

LANDOLT

31-611-21 21,0 cm, 8 1/4"
31-613-25 25,0 cm, 9 3/4"



horizontal
horizontal
horizontal
orizzontale

Fig.
18-36D

31-615-21 20,0 cm, 8 1/8"



vertikal
vertical
vertical
verticale

Fig.
18-36D

31-616-21 20,0 cm, 8 1/8"

Griff mit Spannutter
 Handle with chuck
 Asa con mandril de sujeción
 Manico con mandrino



JACOBSON

31-650-00 10,5 cm, 4 1/4"

Gefäßmesser
 Vessel knife
 Cuchillos para vasos
 Bisturi per vasi



JACOBSON

31-650-01 9,5 cm, 3 3/4"



31-660-16

Gefäßspreizer
 Vessel spreader
 Retractores vasculares
 Divaricatore vasi



BIEMER

31-660-16 16,0 cm, 6 1/4"



Ø 0,5 mm
31-663-05



Ø 1,0 mm
31-663-10



Ø 1,5 mm
31-663-15



Gefäßdilatoren
 Vessel dilators
 Diladores vasculares
 Dilatori vascolari

31-663-05 - 31-663-15 12,5 cm, 5"



31-664-18
 Knopfsonde
 Buttoned probe
 Sonda abotonata
 Sonda bottonuta



31-665-18
 Doppelsonde
 Twin probe
 Sonda doble
 Sond doppia



31-666-18
 Fadengabel
 Ligature pusher
 Empujador de sutura
 Punzone per sutura



JACOBSON

31-664-18 - 31-666-18 18,5 cm, 7 1/4"

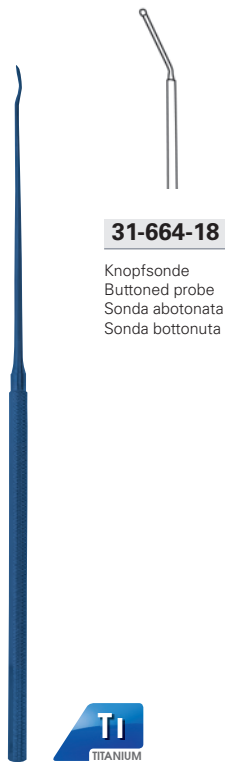

31-664-18 T

Knopfsonde
Buttoned probe
Sonda abotonata
Sonda bottonuta



31-666-18 T

Fadengabel
Ligature pusher
Empujador de sutura
Punzone per sutura



31-667-23

Fadengabel
Ligature pusher
Empujador de sutura
Punzone per sutura



JACOBSON

31-664-18 T - 31-666-18 T 18,5 cm, 7 ¼"

CASPAR

31-667-23 23,0 cm, 9"



3,0 mm

31-668-03



4,0 mm

31-668-04



5,0 mm

31-668-05



8,0 mm

31-668-08

Tumorgabeln
Tumor forks
Empujador de tumor
Punzone per tumore

OKONEK-YASARGIL

31-668-03 - 31-668-08 23,0 cm, 9"

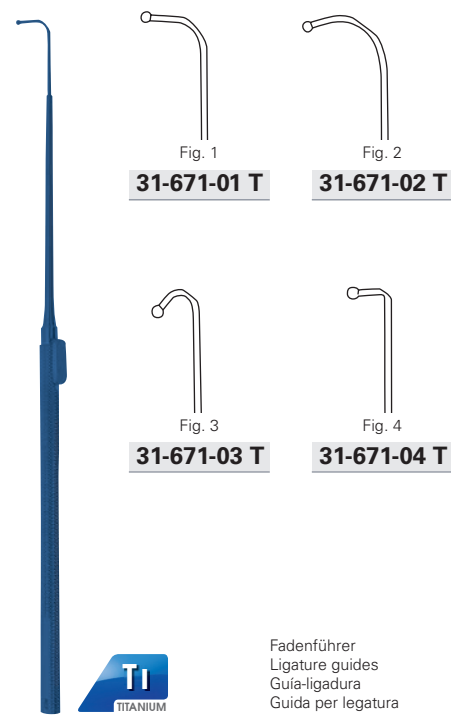
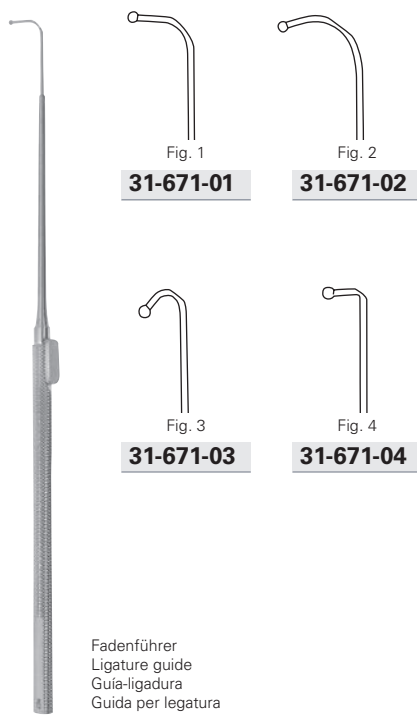

YASARGIL

31-671-01 - 31-671-04 18,5 cm, 7 ¼"

YASARGIL

31-671-01 T - 31-671-04 T 18,5 cm, 7 ¼"

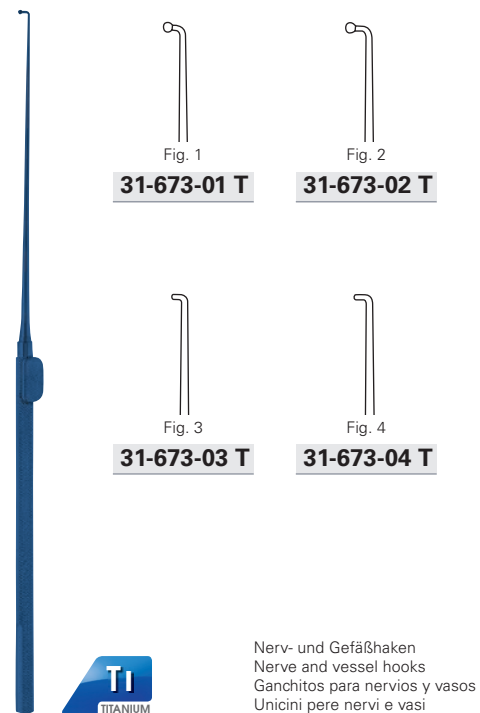
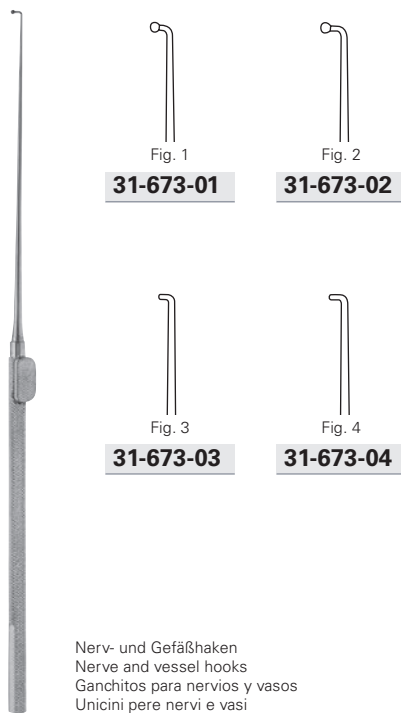

KRAYENBUEHL

31-673-01 - 31-673-04 18,5 cm, 7 ¼"

KRAYENBUEHL

31-673-01 T - 31-673-04 T 18,5 cm, 7 ¼"



Ø 1,8 mm

31-674-18

Gewebekralle
Tissue Pick
Garra para tejidos
Artiglio per tessuti

31-674-18 18,5 cm, 7 ¼"



31-675-01

Scharfes Häkchen
Sharp Hook
Ganchito muy fino
Uncino delicato

31-675-01 18,5 cm, 7 ¼"



31-675-01 T

Scharfes Häkchen
Sharp Hook
Ganchito muy fino
Uncino delicato



31-675-01 T 18,5 cm, 7 ¼"



90°

31-675-02

Scharfes Häkchen
Sharp Hook
Ganchito muy fino
Uncino delicato

31-675-02 18,5 cm, 7 ¼"



90°

31-675-02 T

Scharfes Häkchen
Sharp Hook
Ganchito muy fino
Uncino delicato



31-675-02 T 18,5 cm, 7 ¼"

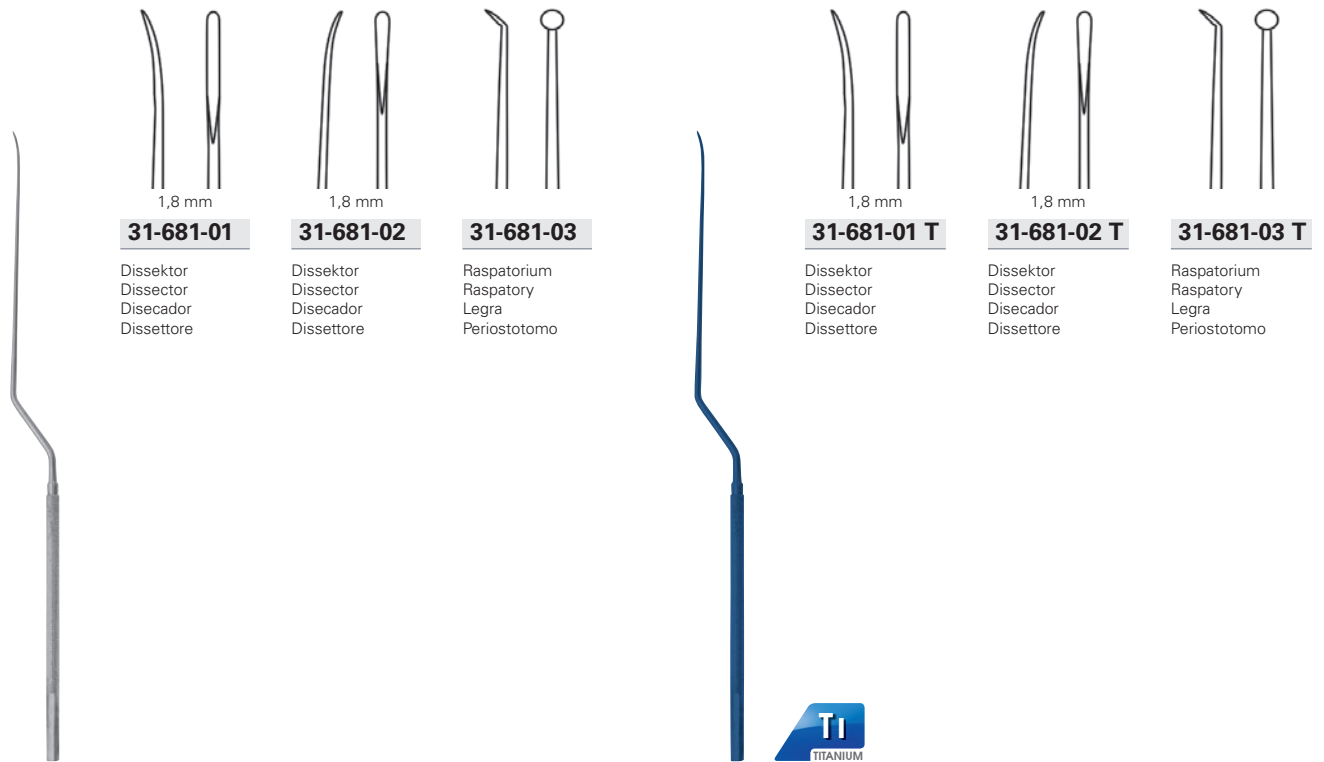

31-681-01 - 31-681-03 23,0 cm, 9 "

31-681-01 T - 31-681-03 T 23,0 cm, 9 "

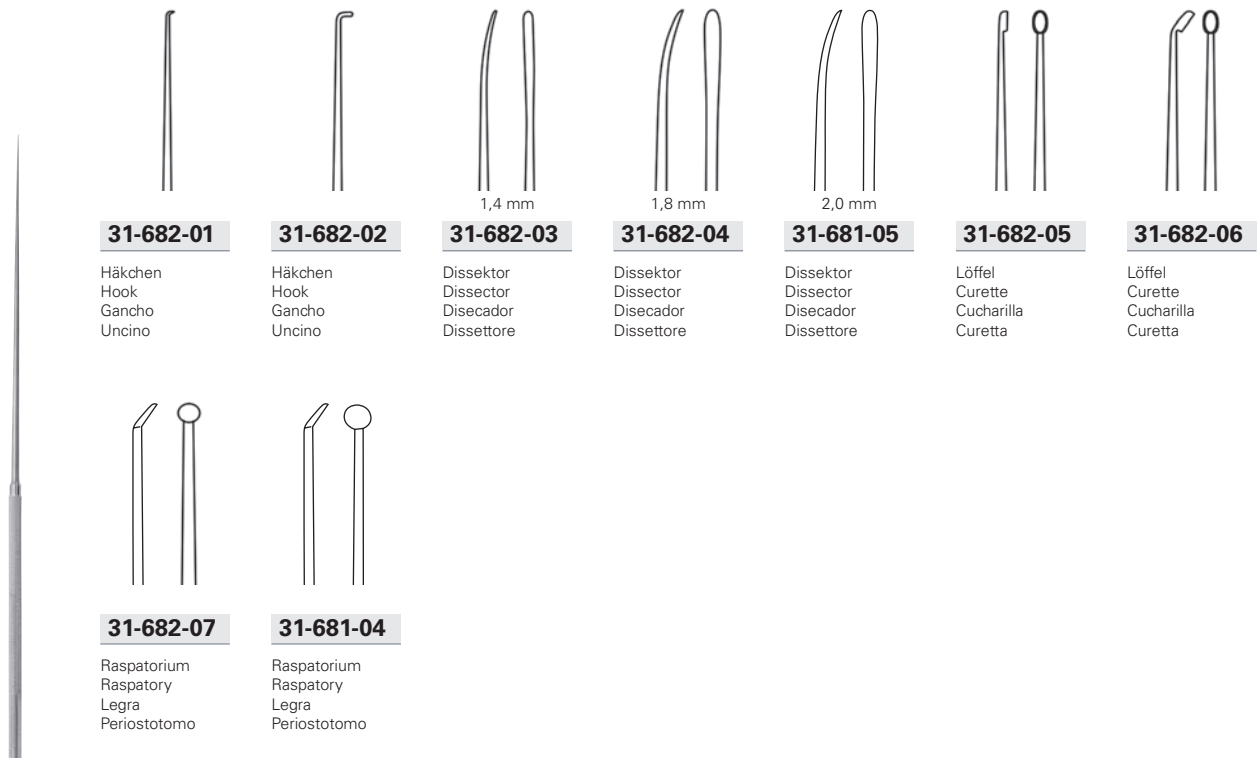

31-681-04 - 31-682-07 23,0 cm, 9 "

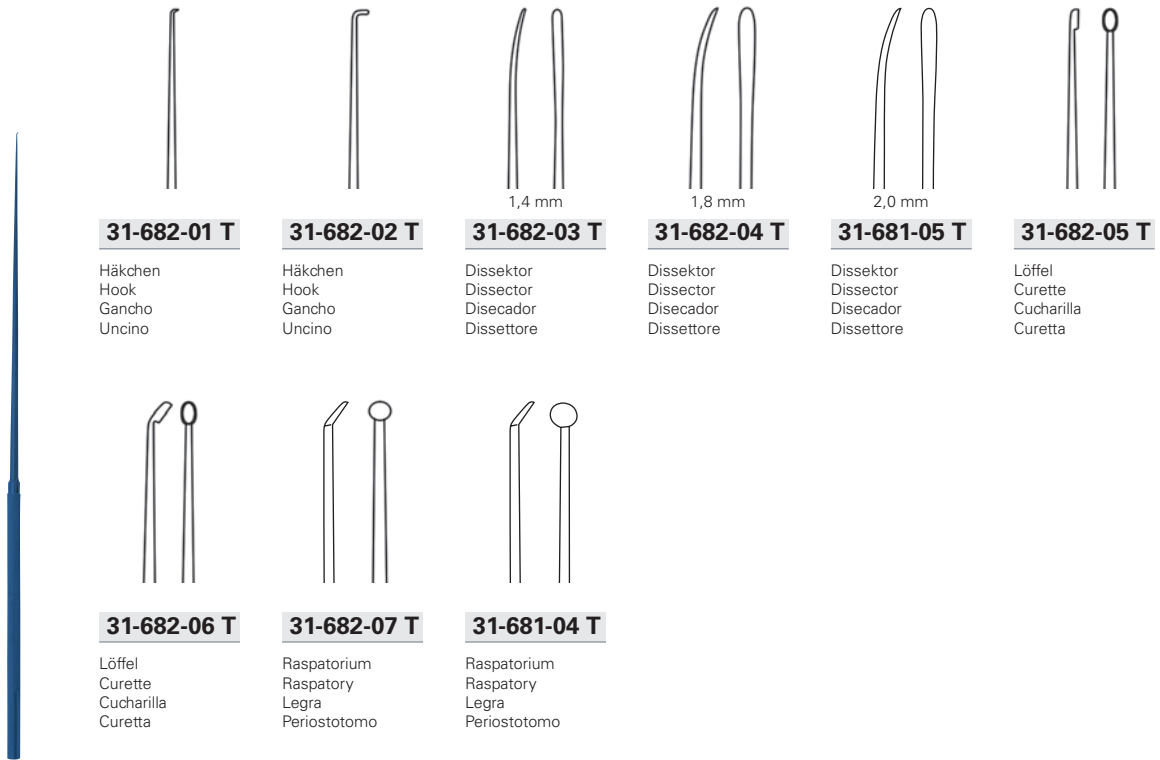

31-681-04 T - 31-682-07 T 23,0 cm, 9"



CASPAR

31-684-01 23,0 cm, 9"

CASPAR

31-684-01 T 23,0 cm, 9"



31-684-02

Dissektor
 Dissector
 Disecador
 Dissettore

31-684-03

Dissektor
 Dissector
 Disecador
 Dissettore

CASPAR

31-684-02 - 31-684-03 23,0 cm, 9 "

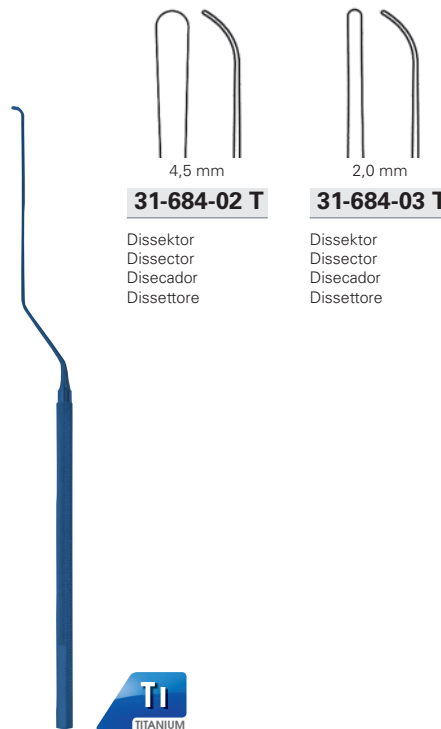

31-684-02 T

Dissektor
 Dissector
 Disecador
 Dissettore

31-684-03 T

Dissektor
 Dissector
 Disecador
 Dissettore

CASPAR

31-684-02 T - 31-684-03 T 23,0 cm, 9 "



31-686-01

Dissektor
 Dissector
 Disecador
 Dissettore

CASPAR

31-686-01 20,0 cm, 8 "



31-685-01

Dissektor
 Dissector
 Disecador
 Dissettore

31-685-02

Dissektor
 Dissector
 Disecador
 Dissettore

CASPAR

31-685-01 - 31-685-02 21,0 cm, 8 ¼ "

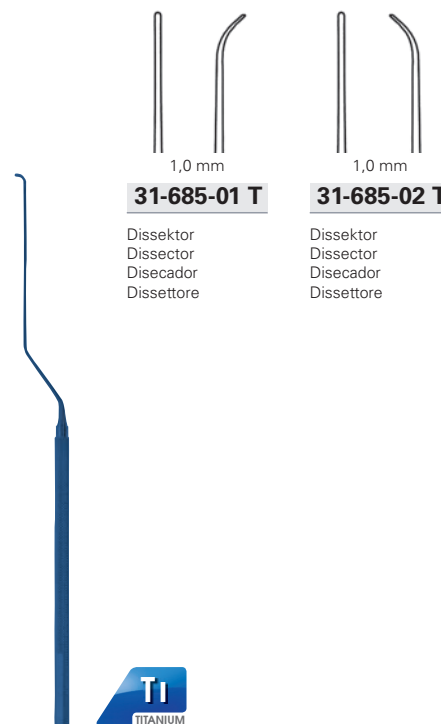

31-685-01 T

Dissektor
 Dissector
 Disecador
 Dissettore

31-685-02 T

Dissektor
 Dissector
 Disecador
 Dissettore

CASPAR

31-685-01 T - 31-685-02 T 21,0 cm, 8 ¼ "



31-686-01 T

Dissektor
 Dissector
 Disecador
 Dissettore

CASPAR

31-686-01 T 20,0 cm, 8 "

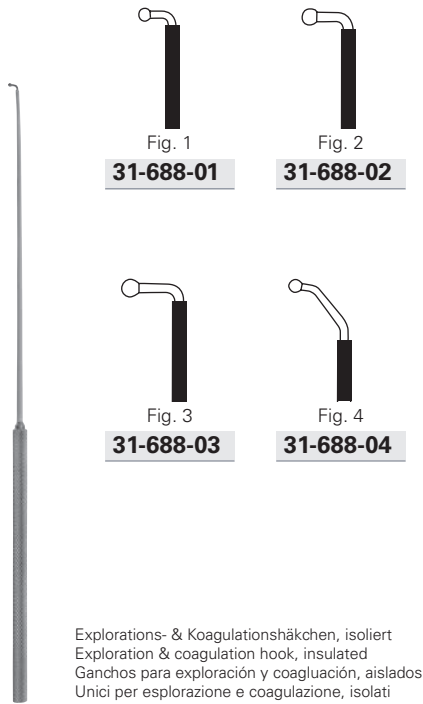

CASPAR

31-688-01 - 31-688-04 24,5 cm, 9 2/3 "

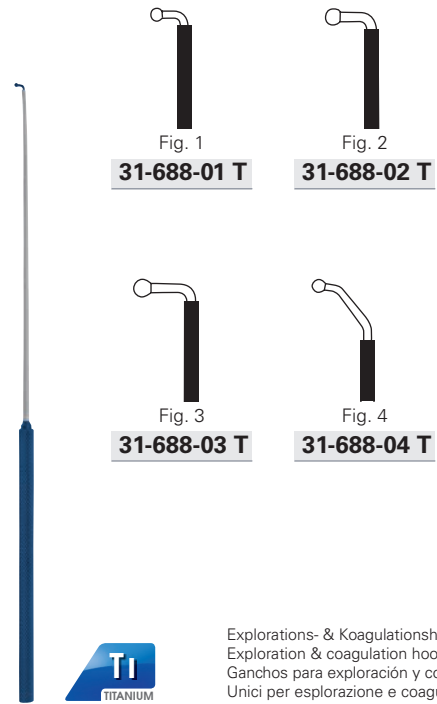

CASPAR

31-688-01 T - 31-688-04 T 24,5 cm, 9 2/3 "

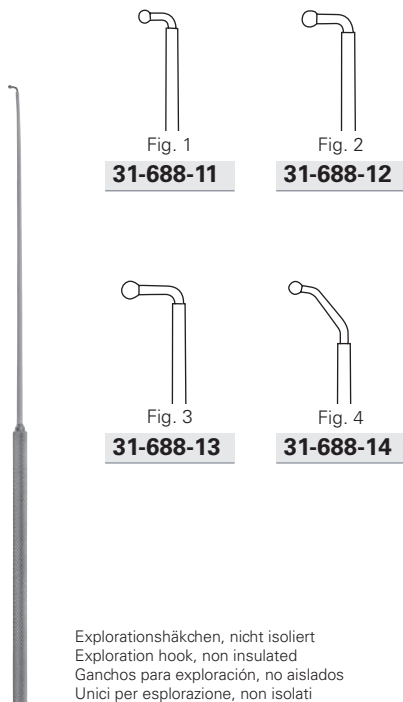

CASPAR

31-688-11 - 31-688-14 24,5 cm, 9 2/3 "

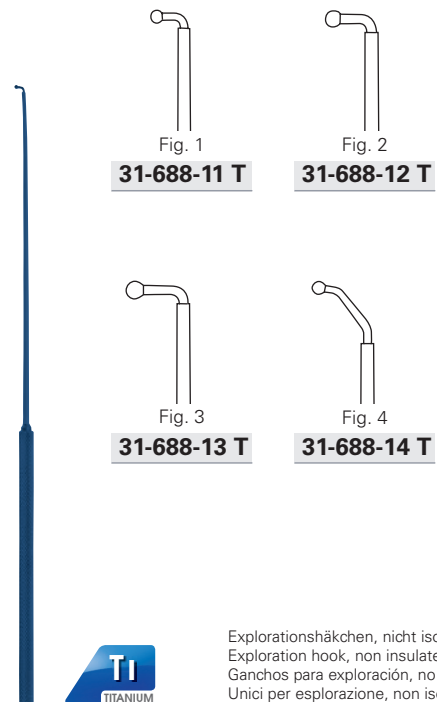

CASPAR

31-688-11 T - 31-688-14 T 24,5 cm, 9 2/3 "

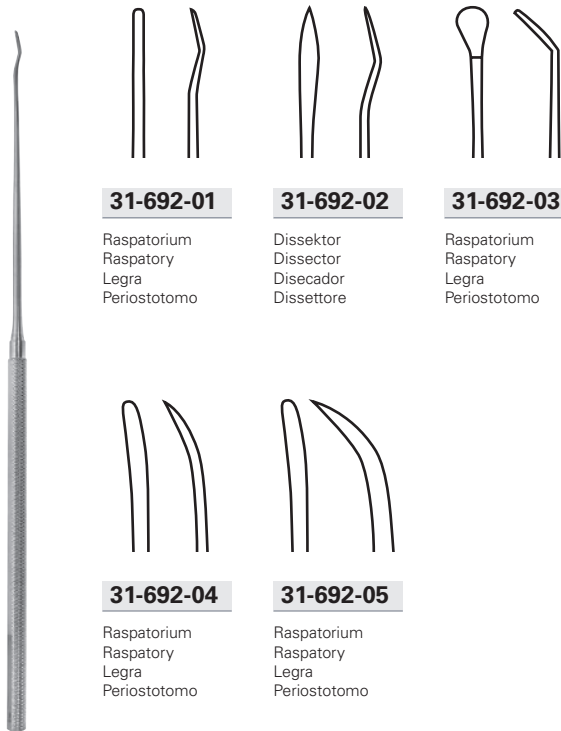

31-692-01

Raspatorium
 Raspatory
 Legra
 Periostotomo

31-692-02

Dissektor
 Dissector
 Disecador
 Dissettore

31-692-03

Raspatorium
 Raspatory
 Legra
 Periostotomo

31-692-04

Raspatorium
 Raspatory
 Legra
 Periostotomo

31-692-05

Raspatorium
 Raspatory
 Legra
 Periostotomo

YASARGIL

31-692-01 - 31-692-05 18,5 cm, 7 1/4"

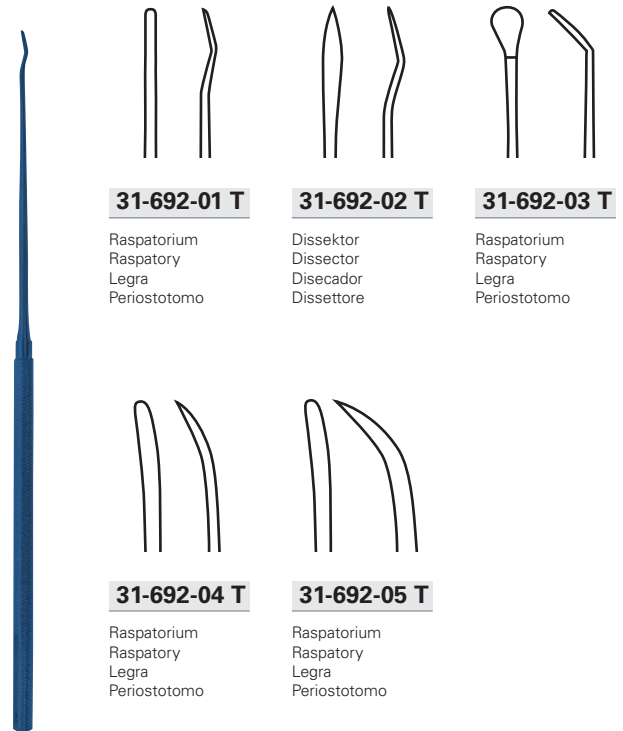

31-692-01 T

Raspatorium
 Raspatory
 Legra
 Periostotomo

31-692-02 T

Dissektor
 Dissector
 Disecador
 Dissettore

31-692-03 T

Raspatorium
 Raspatory
 Legra
 Periostotomo

31-692-04 T

Raspatorium
 Raspatory
 Legra
 Periostotomo

31-692-05 T

Raspatorium
 Raspatory
 Legra
 Periostotomo

YASARGIL



31-692-01 T - 31-692-05 T 18,5 cm, 7 1/4"

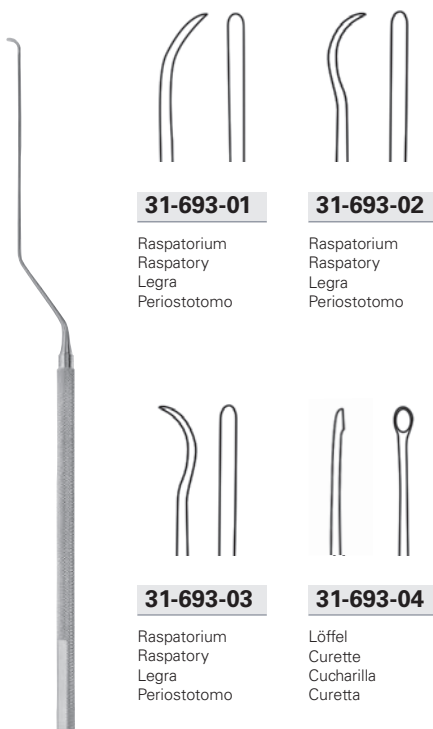

31-693-01

Raspatorium
 Raspatory
 Legra
 Periostotomo

31-693-02

Raspatorium
 Raspatory
 Legra
 Periostotomo

31-693-03

Raspatorium
 Raspatory
 Legra
 Periostotomo

31-693-04

Löffel
 Curette
 Cucharilla
 Curetta

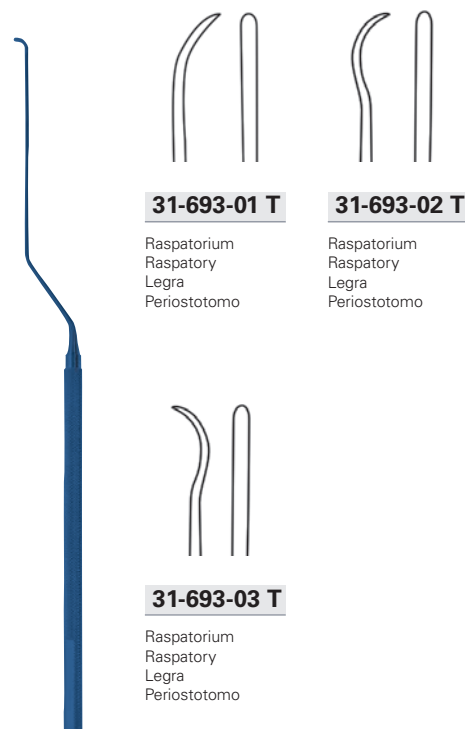

31-693-01 T

Raspatorium
 Raspatory
 Legra
 Periostotomo

31-693-02 T

Raspatorium
 Raspatory
 Legra
 Periostotomo

31-693-03 T

Raspatorium
 Raspatory
 Legra
 Periostotomo

YASARGIL

31-693-01 - 31-693-04 18,5 cm, 7 1/4"

YASARGIL



31-693-01 T - 31-693-03 T 18,5 cm, 7 1/4"



1,0 mm

31-694-10
31-695-10



1,5 mm

31-694-15
31-695-15



2,0 mm

31-694-20
31-695-20



2,5 mm

31-694-25
31-695-25



3,0 mm

31-694-30
31-695-30



3,5 mm

31-694-35
31-695-35



4,0 mm

31-694-40
31-695-40



5,0 mm

31-694-50
31-695-50

Tumormesser, oval
Tumor knives, oval
Cuchillo del tumor, oval
Lama del tumore, ovale

SAMII

31-694-10 - 31-694-50 20,0 cm, 8 "

31-695-10 - 31-695-50 23,0 cm, 9 "



1,0 mm

31-694-10 T
31-695-10 T



1,5 mm

31-694-15 T
31-695-15 T



2,0 mm

31-694-20 T
31-695-20 T



2,5 mm

31-694-25 T
31-695-25 T



3,0 mm

31-694-30 T
31-695-30 T



3,5 mm

31-694-35 T
31-695-35 T



4,0 mm

31-694-40 T
31-695-40 T



5,0 mm

31-694-50 T
31-695-50 T

Tumormesser, oval
Tumor knives, oval
Cuchillo del tumor, oval
Lama del tumore, ovale

SAMII



31-694-10 T - 31-694-50 T 20,0 cm, 8 "

31-695-10 T - 31-695-50 T 23,0 cm, 9 "

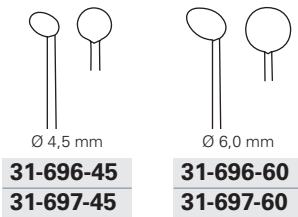
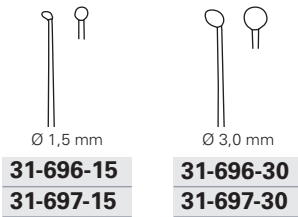

Tumormesser, rund
 Tumor knives, round
 Cuchillo del tumor, redondo
 Lama del tumore, redondo

SAMII

31-696-15 - 31-696-60 20,0 cm, 8 "
31-697-15 - 31-697-60 23,0 cm, 9 "

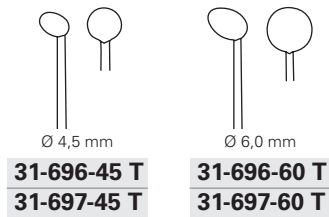
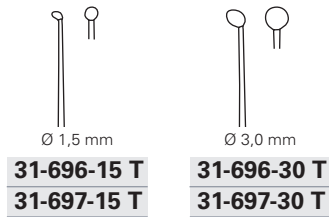

Tumormesser, rund
 Tumor knives, round
 Cuchillo del tumor, redondo
 Lama del tumore, redondo

SAMII



31-696-15 T - 31-696-60 T 20,0 cm, 8 "
31-697-15 T - 31-697-60 T 23,0 cm, 9 "

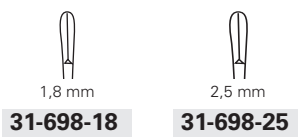

Lanzettenmesser, oval
 Lancet knives, oval
 Bisturí de lanceta, oval
 Bisturi a lancetta, ovale

SAMII

31-698-18 - 31-698-25 23,0 cm, 9 "

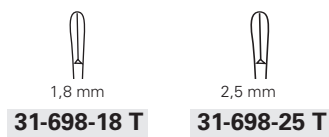

Lanzettenmesser, oval
 Lancet knives, oval
 Bisturí de lanceta, redondo
 Bisturi a lancetta, rotondo

SAMII



31-698-18 T - 31-698-25 T 23,0 cm, 9 "



31-699-01

Gefäßmesser
Vessel knife
Cuchillos para vasos
Bisturi per vasi

JACOBSON

31-699-01 18,5 cm, 7 ¼"



31-699-01 T

Gefäßmesser
Vessel knife
Cuchillos para vasos
Bisturi per vasi



JACOBSON

31-699-01 T 18,5 cm, 7 ¼"



31-699-10

Gefäßmesser
Vessel knife
Cuchillos para vasos
Bisturi per vasi

KRAUS

31-699-10 18,5 cm, 7 ¼"



31-699-02



31-699-03



31-699-04



31-699-05



31-699-06



31-699-07



Gefäßmesser
Vessel knives
Cuchillos para vasos
Bisturi per vasi

KOOS

31-699-02 - 31-699-07 18,5 cm, 7 ¼"



31-699-08



31-699-09



Gefäßmesser
Vessel knives
Cuchillos para vasos
Bisturi per vasi

YASARGIL

31-699-08 - 31-699-09 18,5 cm, 7 ¼"



31-710-70

Rack für 15 Rhoton Instrumente
(Stahl oder Titan Ausführung)
Rack for 15 Rhoton instruments
(steel or titanium model)
Rack para 15 instrumentos Rhoton
(modelo en acero o titanio)
Supporto per 15 strumenti Rhoton
(acciaio o metallo)

RHOTON

31-710-70 18,5 cm, 7 ¼"

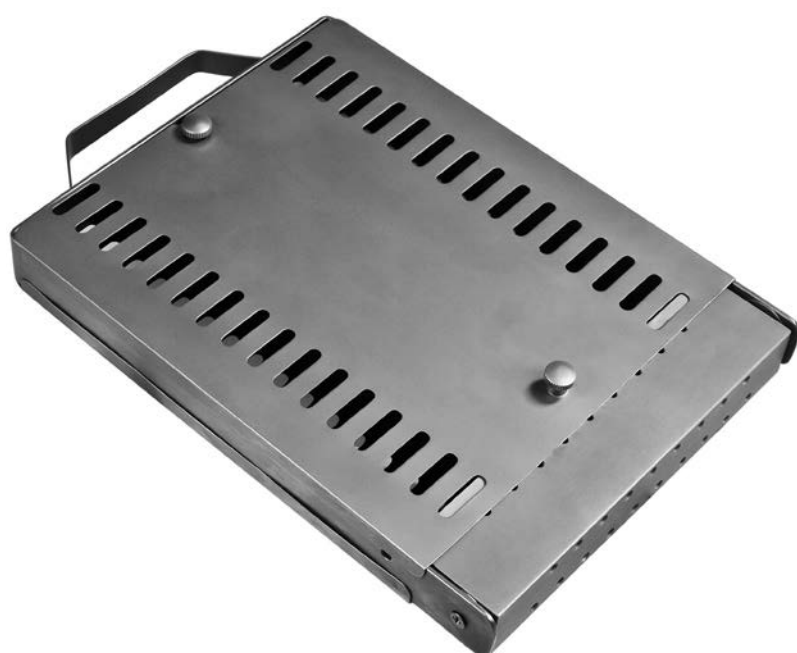

31-710-80

Rack für 19 Rhoton Instrumente
(Stahl oder Titan Ausführung)
Rack for 19 Rhoton instruments
(steel or titanium model)
Rack para 19 instrumentos Rhoton
(modelo en acero o titanio)
Supporto per 19 strumenti Rhoton
(acciaio o metallo)

RHOTON

31-710-80 18,5 cm, 7 ¼"



Fig. 1 1,0 mm
31-710-01
Dissektor
Dissector
Disecador
Dissettore

Fig. 2 2,0 mm
31-710-02
Dissektor
Dissector
Disecador
Dissettore

Fig. 3 3,0 mm
31-710-03
Dissektor
Dissector
Disecador
Dissettore

Fig. 4 1,2 mm
31-710-04
Elevator
Elevator
Elevadores
Elevatori

Fig. 5 2,8 mm
31-710-05
Elevator
Elevator
Elevadores
Elevatori

Fig. 6 1,0 mm
31-710-06
Dissektor
Dissector
Disecador
Dissettore

Fig. 14 1x2 mm
31-710-14
Löffel
Curette
Cucharilla
Curetta

Fig. 15 5,0 mm
31-710-15
Kugeldissektor
Teardrop dissector
Disector esférico
Dissettori sferici

Fig. 16 3,0 mm
31-710-16
Kugeldissektor
Teardrop dissector
Disector esférico
Dissettori sferici

Fig. 17 5,0 mm
31-710-17
Kugeldissektor
Teardrop dissector
Disector esférico
Dissettori sferici

Fig. 18 4,0 mm
31-710-18
Kugeldissektor
Teardrop dissector
Disector esférico
Dissettori sferici

Fig. 19 8,0 mm
31-710-19
Kugeldissektor
Teardrop dissector
Disector esférico
Dissettori sferici

RHOTON

31-710-01 - 31-710-19 19,0 cm, 7 1/2"



Fig. 1 1,0 mm
31-710-01 T
Dissektor
Dissector
Disecador
Dissettore

Fig. 2 2,0 mm
31-710-02 T
Dissektor
Dissector
Disecador
Dissettore

Fig. 3 3,0 mm
31-710-03 T
Dissektor
Dissector
Disecador
Dissettore

Fig. 4 1,2 mm
31-710-04 T
Elevator
Elevator
Elevadores
Elevatori

Fig. 5 2,8 mm
31-710-05 T
Elevator
Elevator
Elevadores
Elevatori

Fig. 6 1,0 mm
31-710-06 T
Dissektor
Dissector
Disecador
Dissettore

Fig. 14 1x2 mm
31-710-14 T
Löffel
Curette
Cucharilla
Curetta

Fig. 15 5,0 mm
31-710-15 T
Kugeldissektor
Teardrop dissector
Disector esférico
Dissettori sferici

Fig. 16 3,0 mm
31-710-16 T
Kugeldissektor
Teardrop dissector
Disector esférico
Dissettori sferici

Fig. 17 5,0 mm
31-710-17 T
Kugeldissektor
Teardrop dissector
Disector esférico
Dissettori sferici

Fig. 18 4,0 mm
31-710-18 T
Kugeldissektor
Teardrop dissector
Disector esférico
Dissettori sferici

Fig. 19 8,0 mm
31-710-19 T
Kugeldissektor
Teardrop dissector
Disector esférico
Dissettori sferici



RHOTON

31-710-01 T - 31-710-19 T 19,0 cm, 7 1/2"

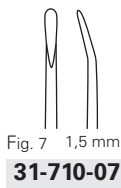

Häkchen
 Hook
 Gancho
 Uncino

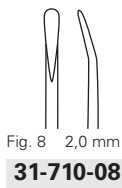

Häkchen
 Hook
 Gancho
 Uncino



Häkchen, halbscharf
 Hook, semi sharp
 Gancho, semi agudo
 Uncini, semi acuto



Häkchen, stumpf
 Hook, blunt
 Gancho, romo
 Uncini, smusso



Häkchen, halbscharf
 Hook, semi sharp
 Gancho, semi agudo
 Uncini, semi acuto

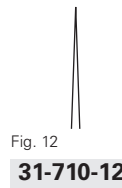

Nadel
 Needle
 Aguja
 Aghi

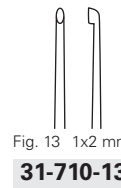

Löffel
 Curette
 Cucharilla
 Curetta



RHOTON SET 15

31-710-50 19,0 cm, 7 1/2"

Bestehend aus | Consisting of | Compuesto de | Composta da

31-710-01 - 31-710-14 | 31-710-16 | 31-710-70 (Rack)



RHOTON SET 19

31-710-60 19,0 cm, 7 1/2"

Bestehend aus | Consisting of | Compuesto de | Composta da

31-710-01 - 31-710-19 | 31-710-80 (Rack)

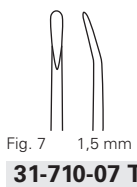

Häkchen
 Hook
 Gancho
 Uncino

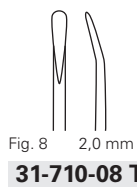

Häkchen
 Hook
 Gancho
 Uncino

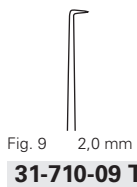

Häkchen, halbscharf
 Hook, semi sharp
 Gancho, semi agudo
 Uncini, semi acuto

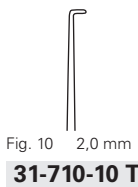

Häkchen, stumpf
 Hook, blunt
 Gancho, romo
 Uncini, smusso

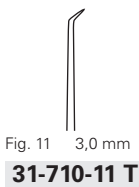

Häkchen, halbscharf
 Hook, semi sharp
 Gancho, semi agudo
 Uncini, semi acuto



Nadel
 Needle
 Aguja
 Aghi

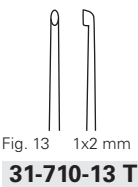

Löffel
 Curette
 Cucharilla
 Curetta



TITAN RHOTON SET 15

31-710-50 T 19,0 cm, 7 1/2"

Bestehend aus | Consisting of | Compuesto de | Composta da

31-710-01 T - 31-710-14 T | 31-710-16 T | 31-710-70 (Rack)



TITAN RHOTON SET 19

31-710-60 T 19,0 cm, 7 1/2"

Bestehend aus | Consisting of | Compuesto de | Composta da

31-710-01 T - 31-710-19 T | 31-710-80 (Rack)





Magen, Darm, Rektum

Stomach, Intestines, Rectum

Estómago, Intestino, Recto

Stomaco, Intestino, Retto

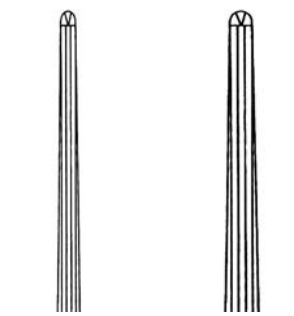

33-100-15

1x2 Zähne
1x2 teeth
1x2 dientes
1x2 denti

33-100-20

1x2 Zähne
1x2 teeth
1x2 dientes
1x2 denti

ALLEN

33-100-15	15,5 cm, 6 1/8"
33-100-20	20,0 cm, 8"

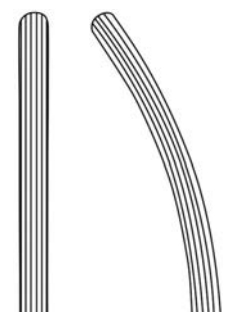

33-102-13

33-103-13

BABY-KOCHER

33-102-13 - 33-103-13	13,0 cm, 5 1/8"
------------------------------	-----------------

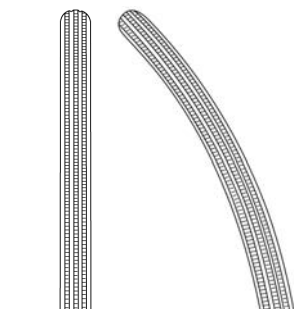

33-104-13

33-105-13



BABY-KOCHER

33-104-13 - 33-105-13	13,0 cm, 5 1/8"
------------------------------	-----------------

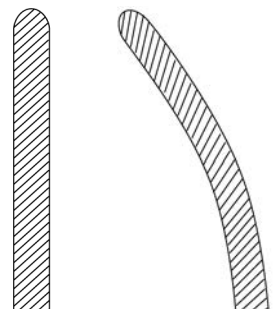

33-108-16

33-108-18

33-109-16

33-109-18

DOYEN

33-108-16 - 33-109-16	16,5 cm, 6 1/2"
33-108-18 - 33-109-18	18,0 cm, 7"



33-110-13
33-110-17
33-110-18
33-110-21
33-110-23

33-111-13
33-111-17
33-111-18
33-111-21
33-111-23



 Verpackungseinheit: 3 St.
 Packing unit: 3 pieces
 Unidad: 3 piezas
 Confezione: 3 pezzi



DOYEN

33-110-13 - 33-111-13	14,0 cm, 5 1/2"
33-110-17 - 33-111-17	17,0 cm, 6 3/4"
33-110-18 - 33-111-18	18,5 cm, 7 1/4"
33-110-21 - 33-111-21	21,5 cm, 8 1/2"
33-110-23 - 33-111-23	23,5 cm, 9 1/4"

DE MARTEL-WOLFSON

33-112-01	50,0 mm
33-112-02	70,0 mm
33-112-03	100,0 mm



Klemmschließzange
 Clamp closing forceps
 Pinza para cerrar los clamps
 Serrapinze

DE MARTEL-WOLFSON

33-113-00 24,5 cm, 9 3/4"



Klemmenhalter
 Clamp holder
 Porta-clamp
 Portapinze

DE MARTEL-WOLFSON

33-113-08 9,5 cm, 3 3/4"

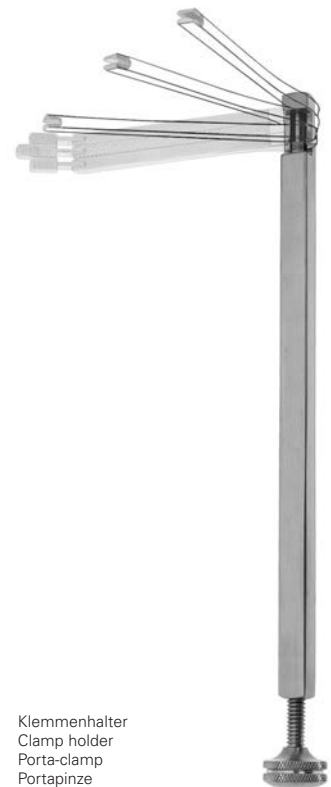

Klemmenhalter
 Clamp holder
 Porta-clamp
 Portapinze

DE MARTEL-WOLFSON

33-113-23 23,0 cm, 9"

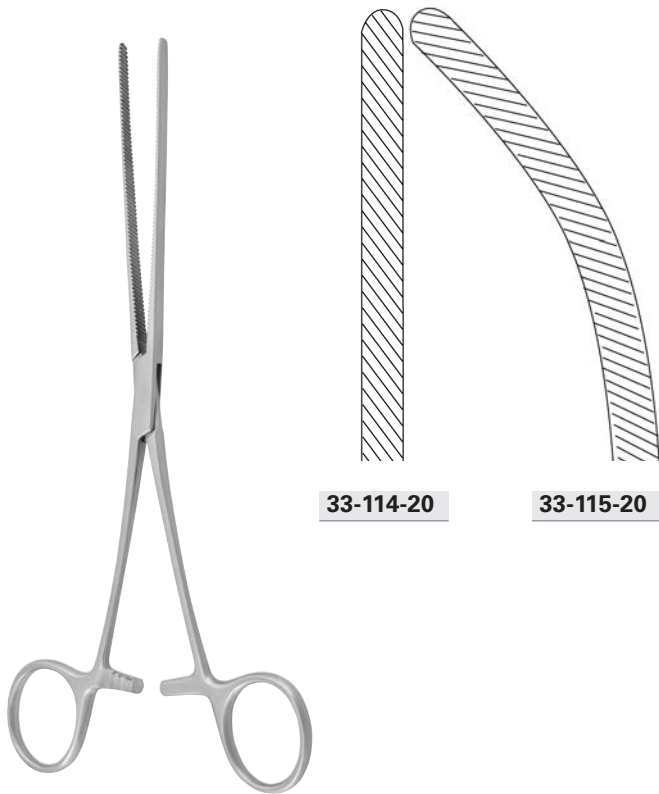

33-114-20

33-115-20

HARTMANN

33-114-20 - 33-115-20 20,0 cm, 8 "

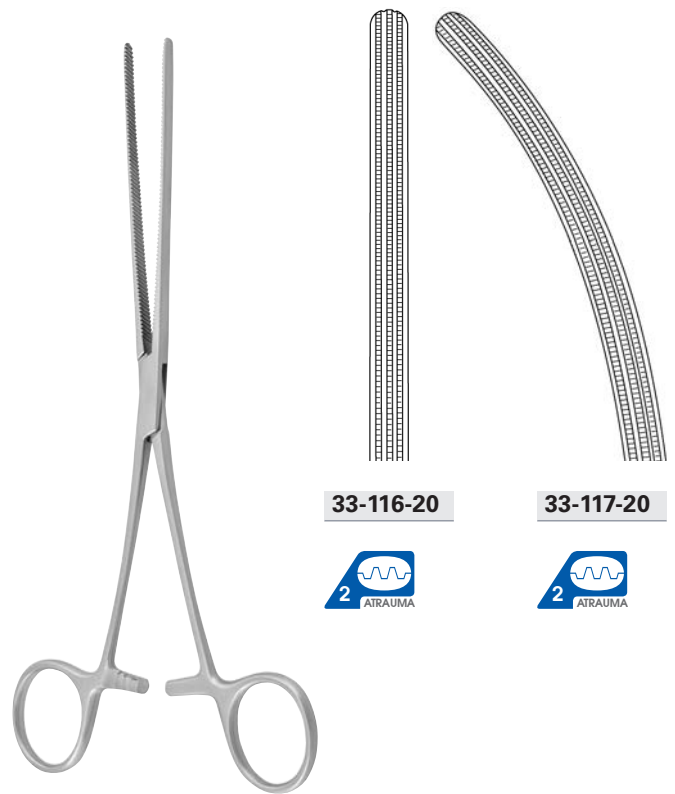

33-116-20

33-117-20



HARTMANN

33-116-20 - 33-117-20 20,0 cm, 8 "

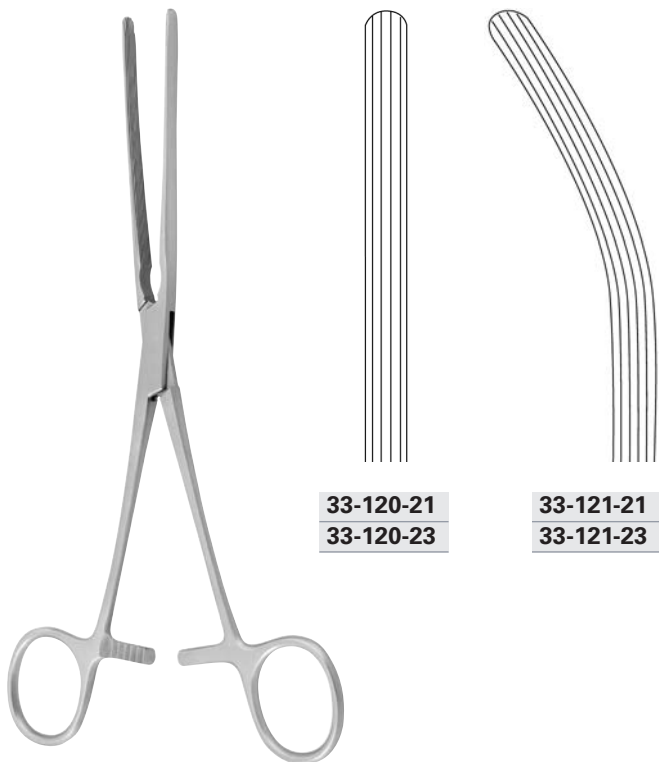

33-120-21
33-120-23

33-121-21
33-121-23

KOCHER

33-120-21 - 33-121-21 21,0 cm, 8 ¼ "
33-120-23 - 33-121-23 23,0 cm, 9 "

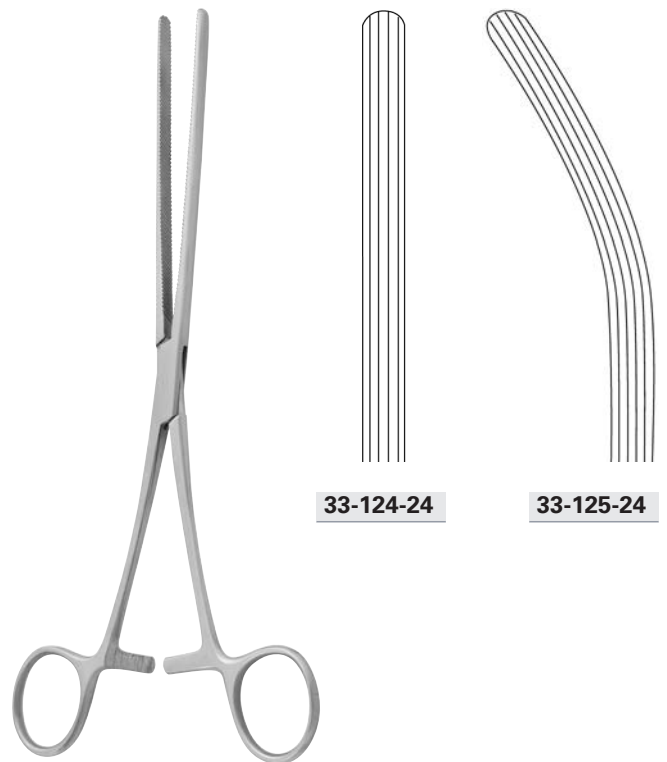

33-124-24

33-125-24

DOYEN

33-124-24 - 33-125-24 24,0 cm, 9 ½ "

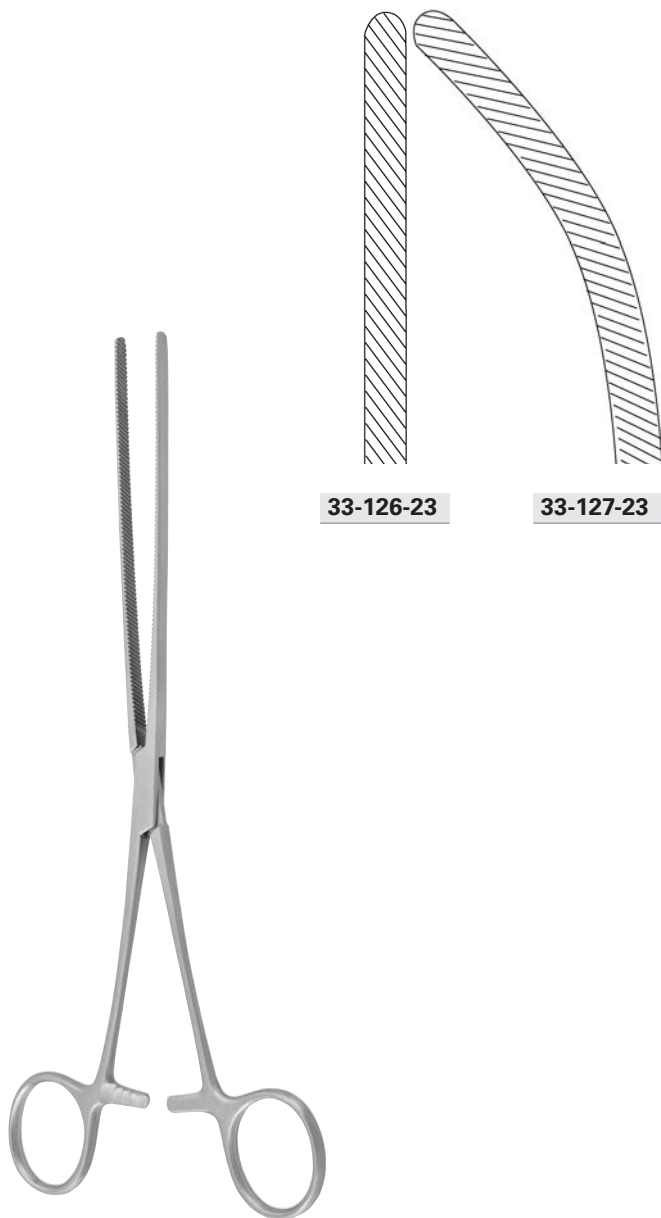

33-126-23

33-127-23

DOYEN

33-126-23 - 33-127-23 23,5 cm, 9 1/4"



33-128-23

33-129-23



DOYEN

33-128-23 - 33-129-23 23,5 cm, 9 1/4"

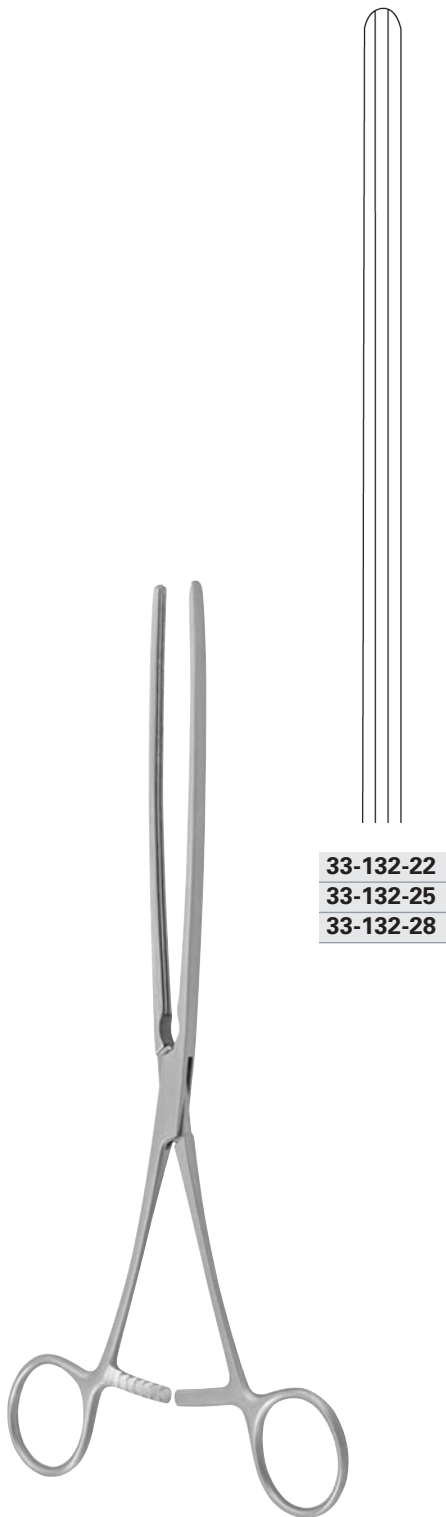

33-132-22
33-132-25
33-132-28



33-133-22
33-133-25
33-133-28

KOCHER

33-132-22 - 33-133-22	22,0 cm, 8 3/4"
33-132-25 - 33-133-25	25,0 cm, 9 3/4"
33-132-28 - 33-133-28	28,0 cm, 11"

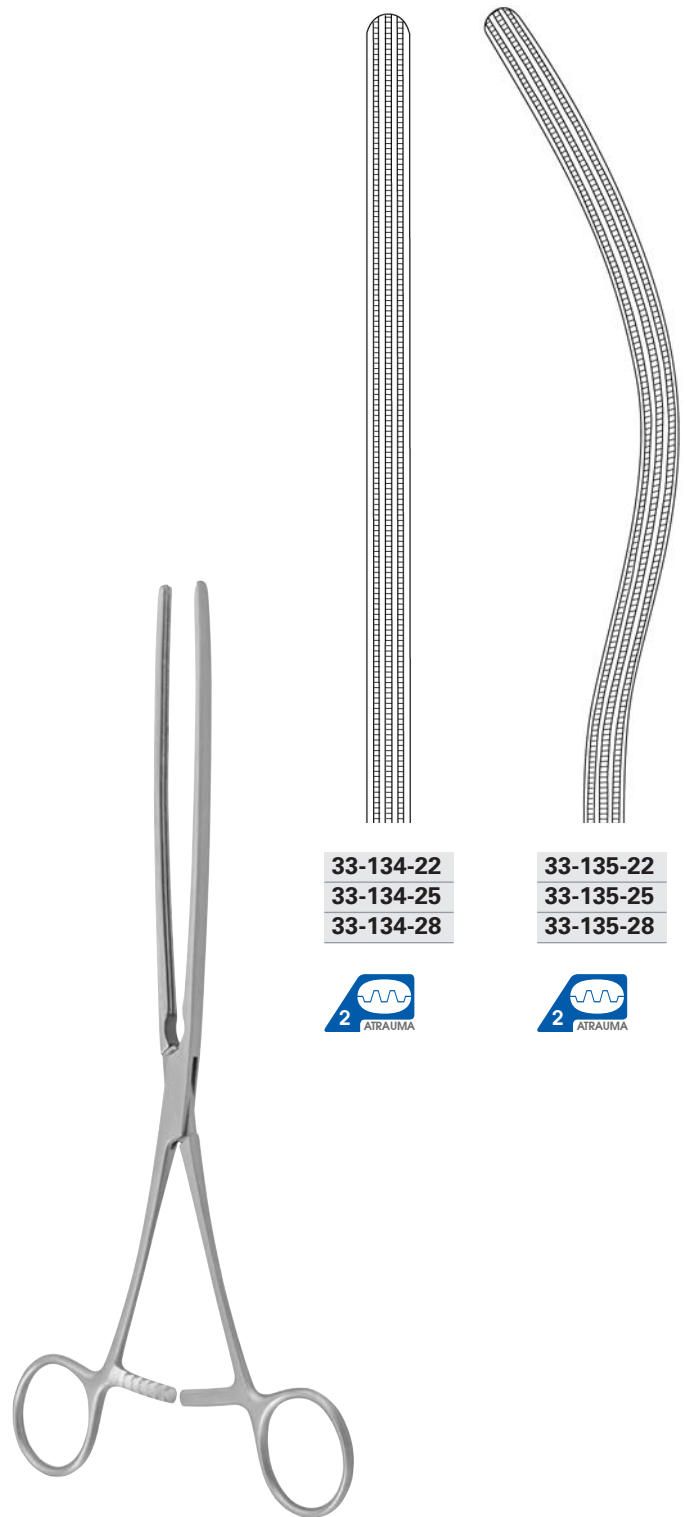

33-134-22
33-134-25
33-134-28

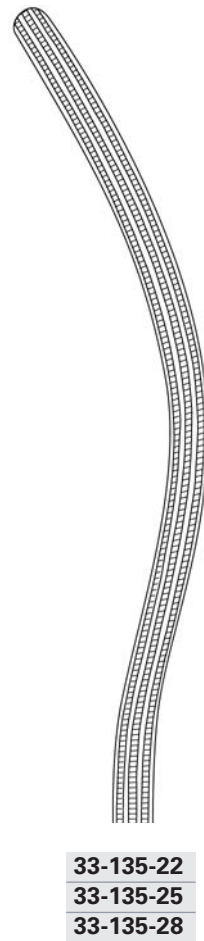

33-135-22
33-135-25
33-135-28



KOCHER

33-134-22 - 33-135-22	22,0 cm, 8 3/4"
33-134-25 - 33-135-25	25,0 cm, 9 3/4"
33-134-28 - 33-135-28	28,0 cm, 11"

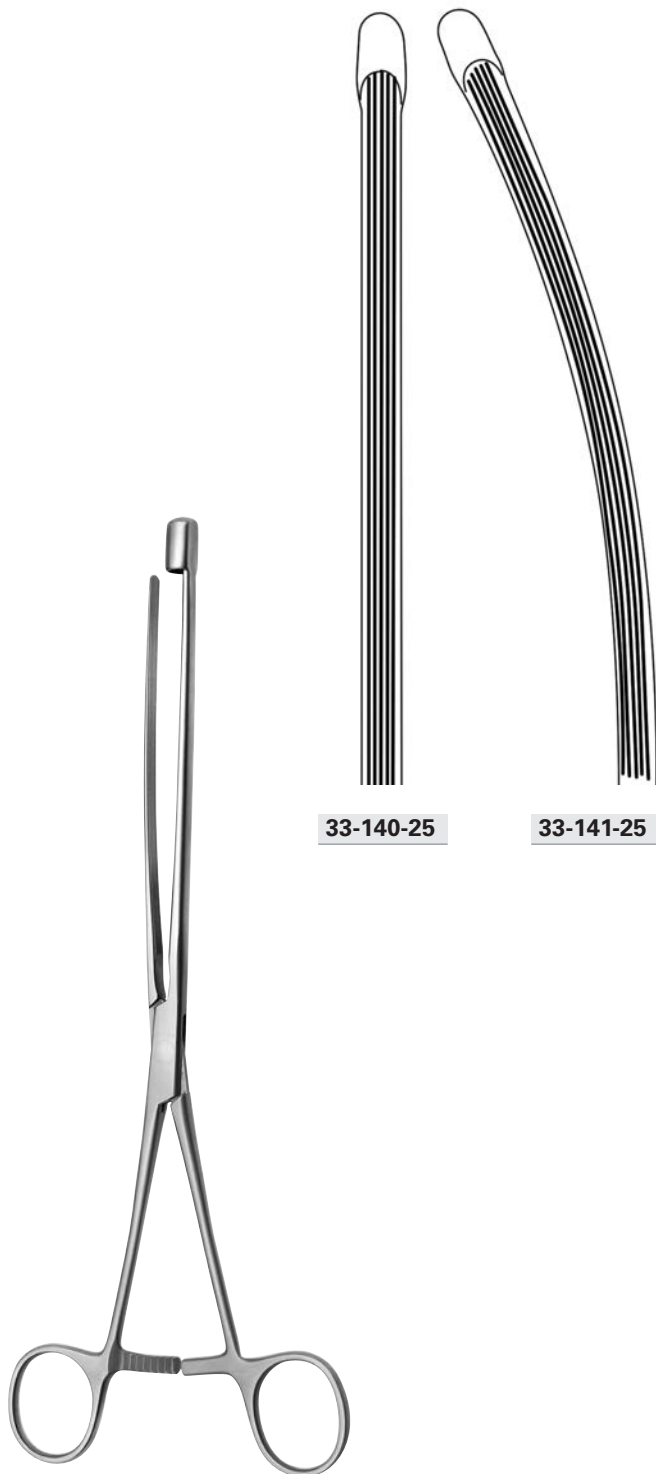

NUSSBAUM

33-140-25 - 33-141-25 25,0 cm, 9 3/4 "

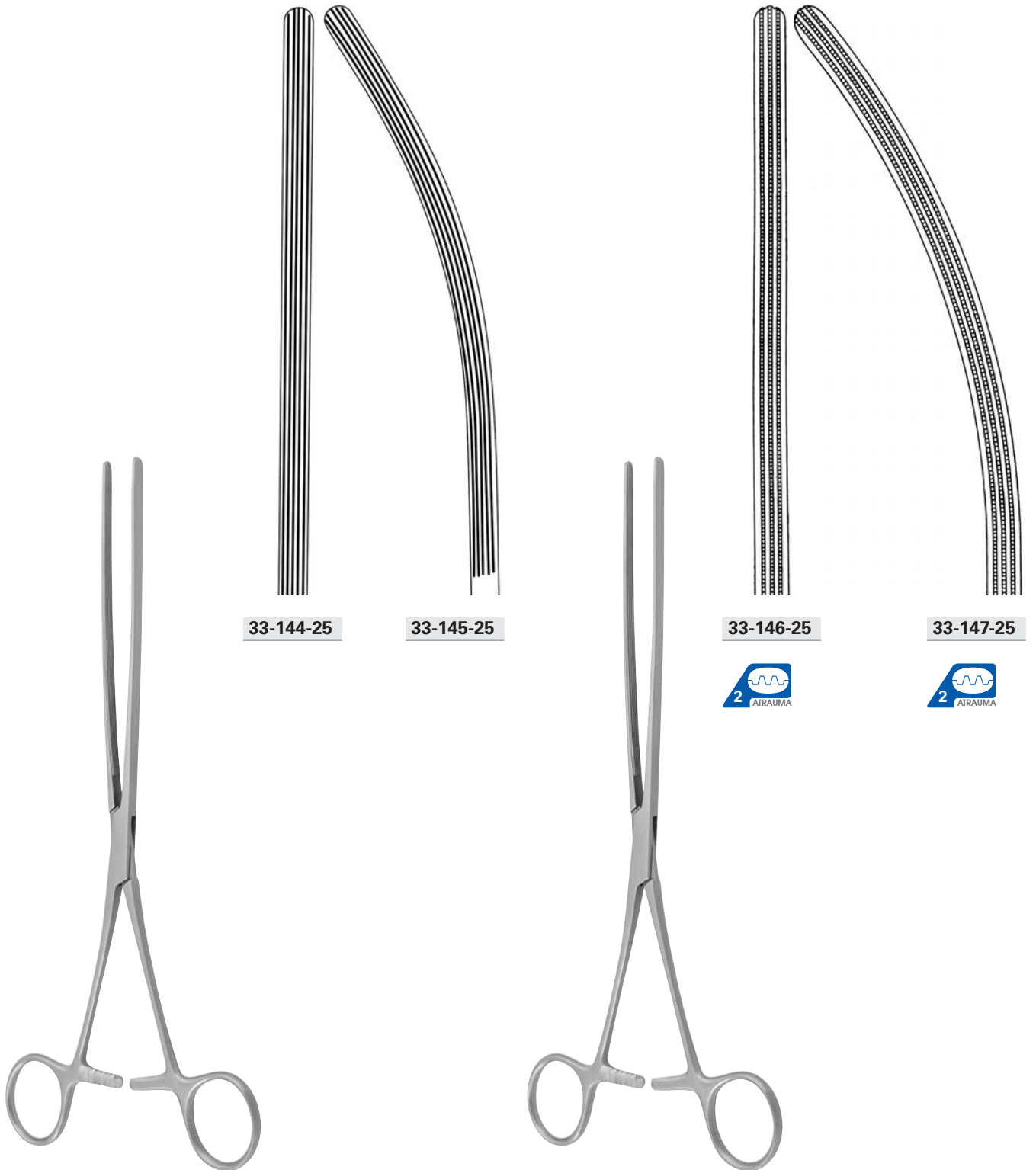

33-144-25

33-145-25

33-146-25

33-147-25



MAYO-ROBSON

33-144-25 - 33-145-25 25,0 cm, 9 3/4"

MAYO-ROBSON

33-146-25 - 33-147-25 25,0 cm, 9 3/4"

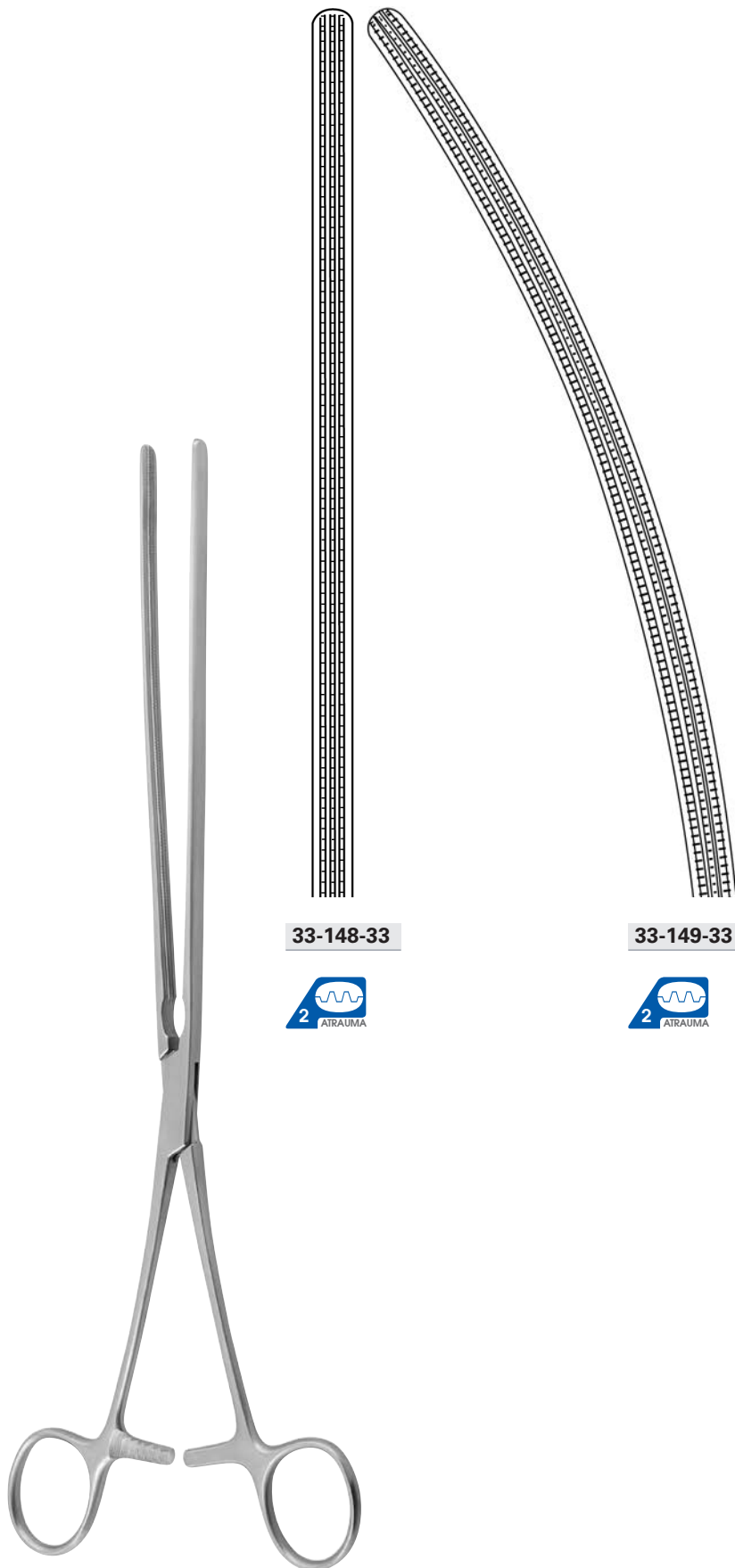

33-148-33



33-149-33



SCUDDER

33-148-33 - 33-149-33 33,0 cm, 13 "



33-150-20
33-150-24

LANG-STEVENSON

33-150-20 20,0 cm, 8 "
33-150-24 24,0 cm, 9 1/4 "



33-152-17
33-152-20

SCHOEMAKER

33-152-17 17,0 cm, 6 3/4 "
33-152-20 20,0 cm, 8 "

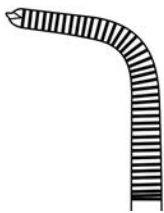

33-153-13

1x2 Zähne
1x2 teeth
1x2 dientes
1x2 denti

KLEINSCHMIDT

33-153-13 13,0 cm, 5 1/8 "



33-153-15

BENSON

33-153-15 15,5 cm, 6 1/8 "

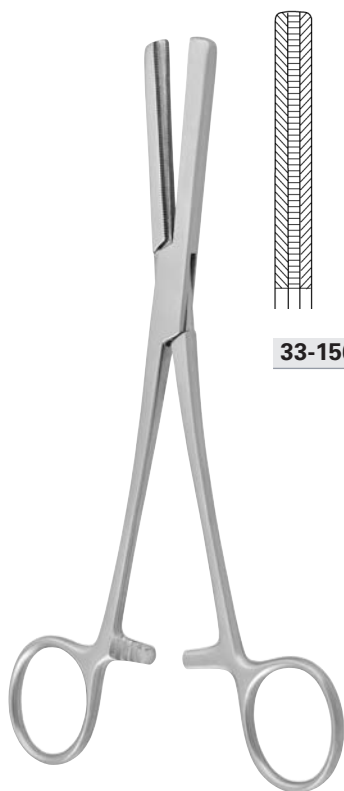

33-156-25

33-156-26

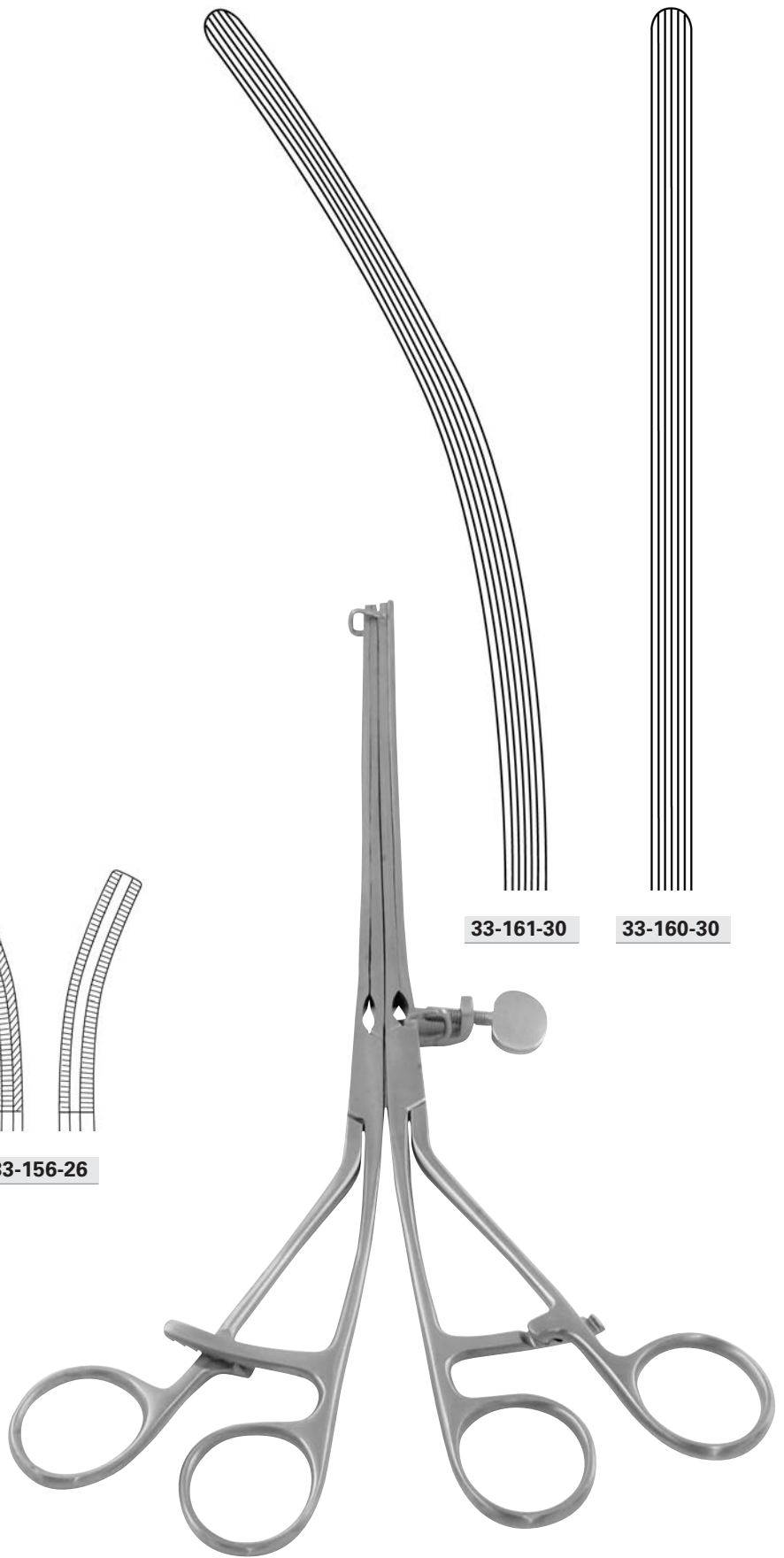

33-161-30

33-160-30

FERGUSSON

33-156-25 - 33-156-26 20,0 cm, 6 3/4"

LANE

33-160-30 - 33-161-30 30,0 cm, 11 3/4"



PAYR

33-167-18 15,0 cm, 6"

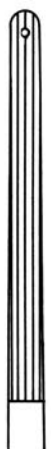

66,0 mm

33-167-18

mit Stift
with pin
con espigna
con perno



68,0 mm

33-167-20

mit Stift
with pin
con espigna
con perno

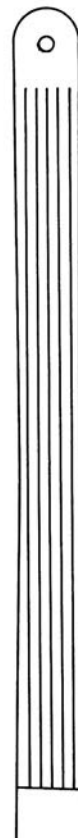

108,0 mm

33-167-27

mit Stift
with pin
con espigna
con perno



146,0 mm

33-167-31

mit Stift
with pin
con espigna
con perno

PAYR

33-167-20	20,0 cm, 8"
33-167-27	27,5 cm, 10 ³ / ₄ "
33-167-31	31,5 cm, 12 ¹ / ₂ "

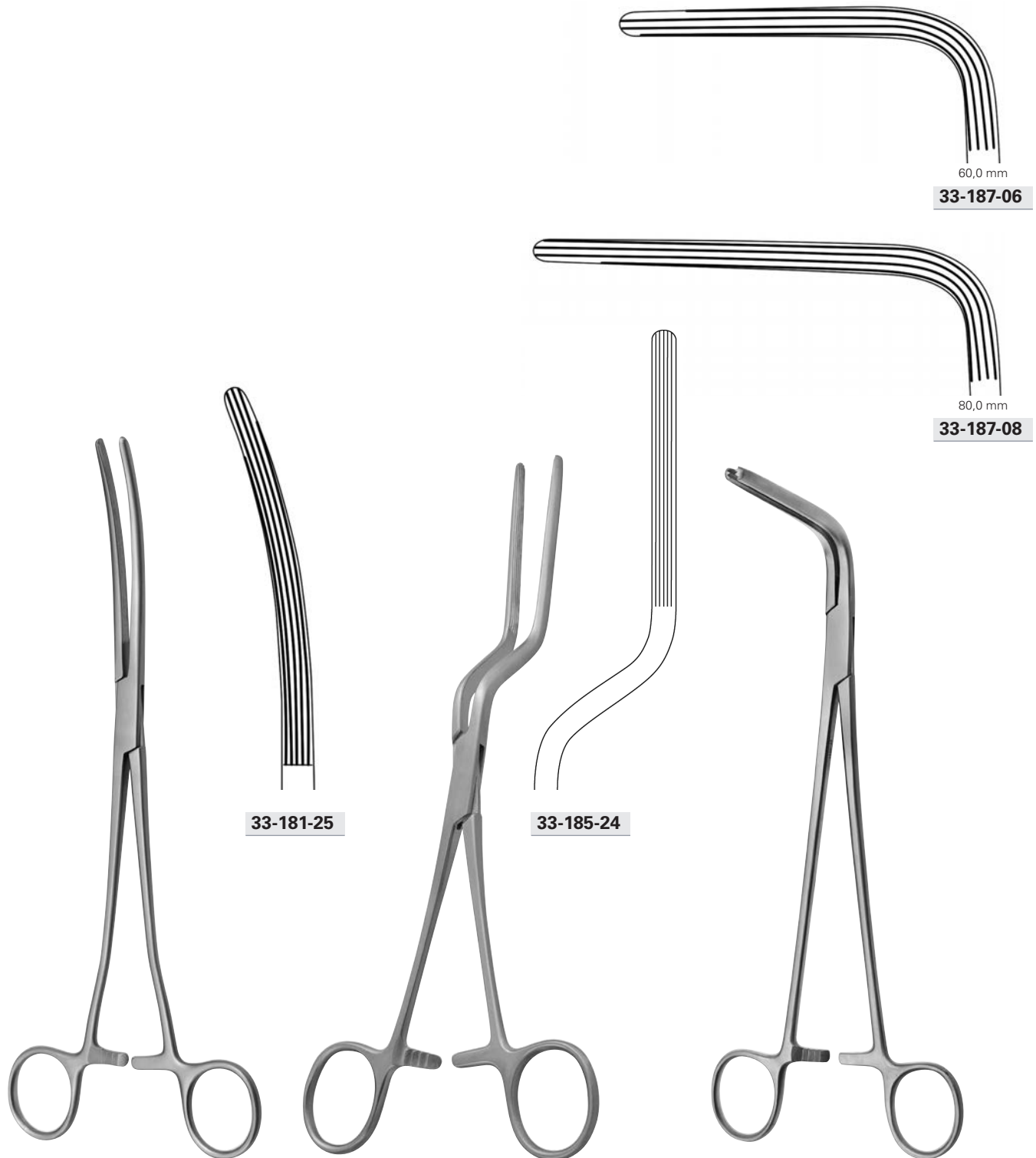

PARKER-KERR

33-181-25 25,0 cm, 9 3/4 "

BRUNNER

33-185-24 24,5 cm, 9 2/3 "

FERGUSSON

33-187-06 - 33-187-08 23,0 cm, 9 "



85,0 mm
33-187-09



FEHLAND

33-187-09 24,0 cm, 9 ½"

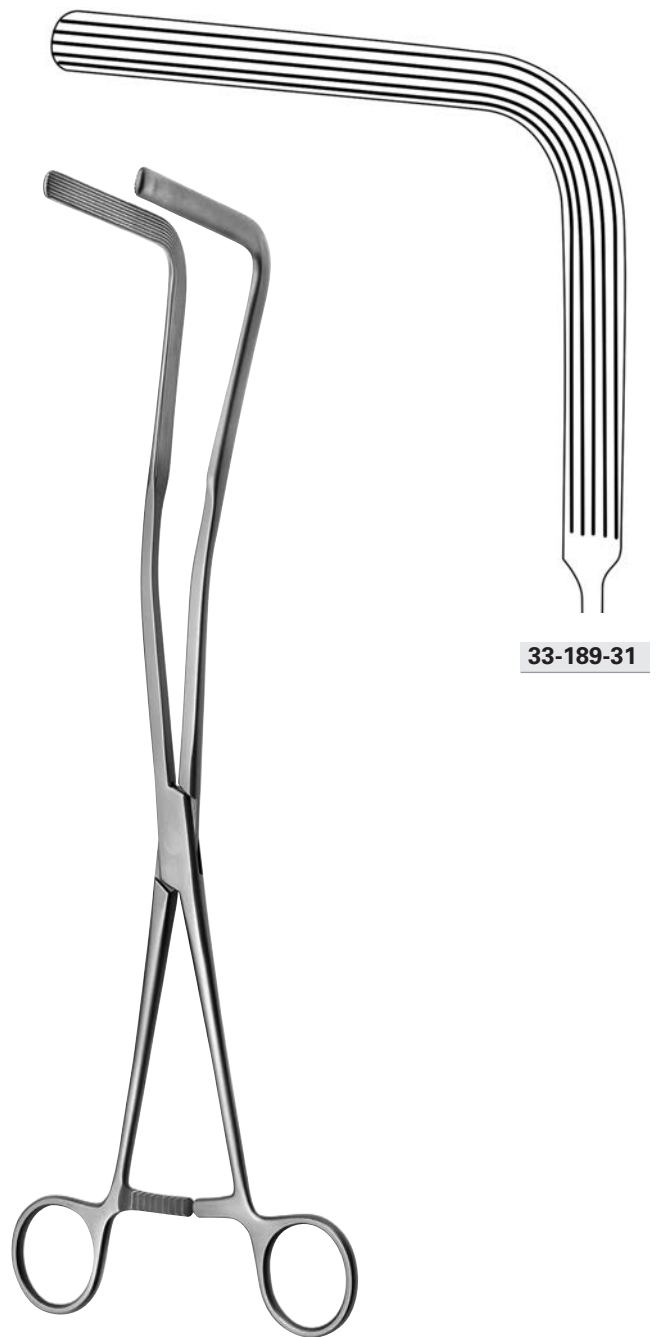

33-189-31

LLOYD-DAVIES

33-189-31 31,5 cm, 12 ½"

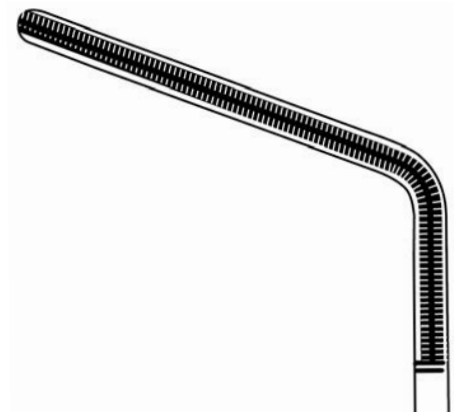

33-191-26

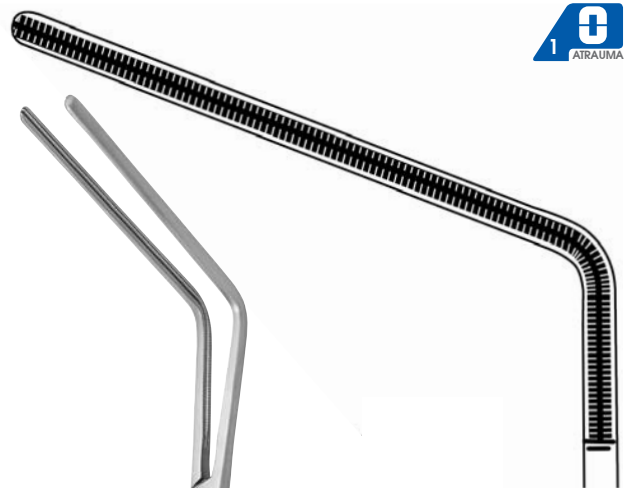

33-191-28



33-191-25

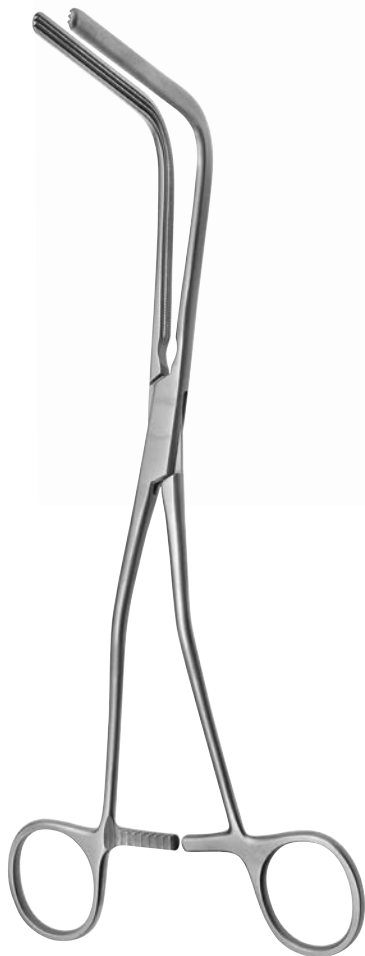

VEIDENHEIMER

33-191-25 25,0 cm, 9 3/4 "



HAYES

33-191-26 27,0 cm, 10 3/4 "
 33-191-28 28,0 cm, 11 "



33-192-37



MUELLER

33-192-37 37,5 cm, 14 3/4"

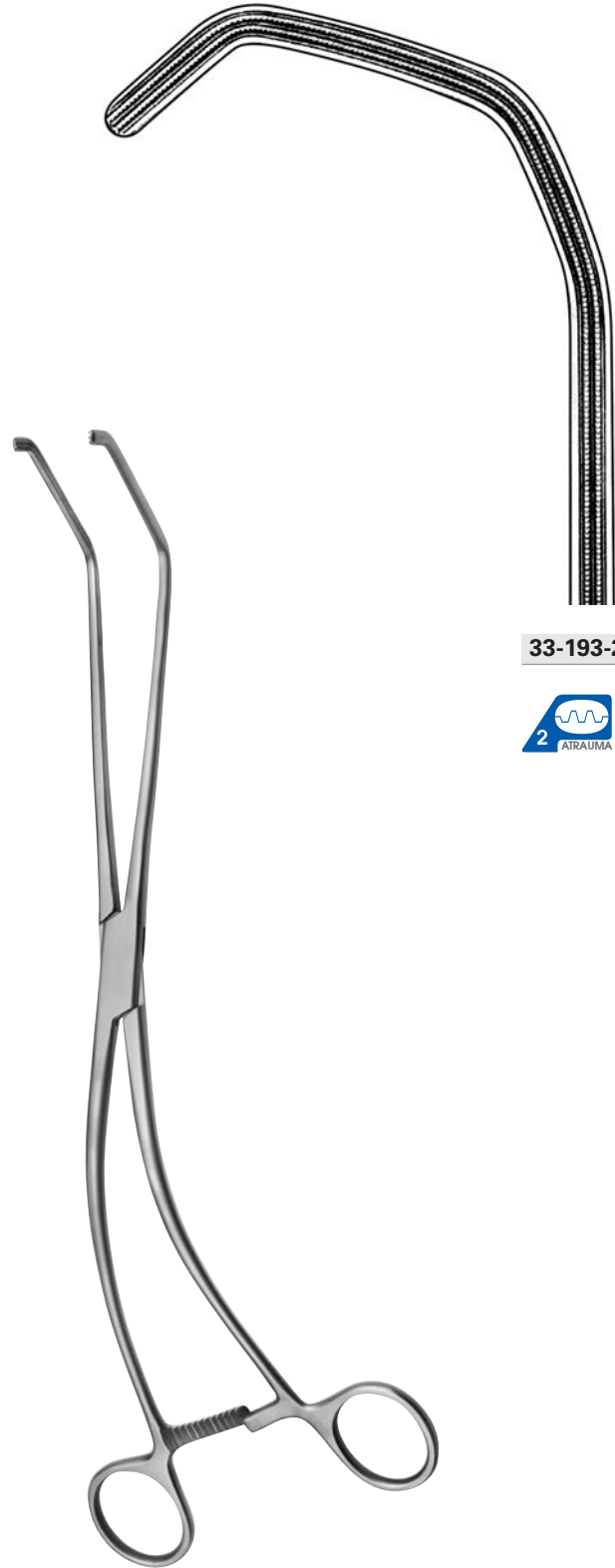

33-193-27



KERSTING

33-193-27 30,0 cm, 11 3/4"

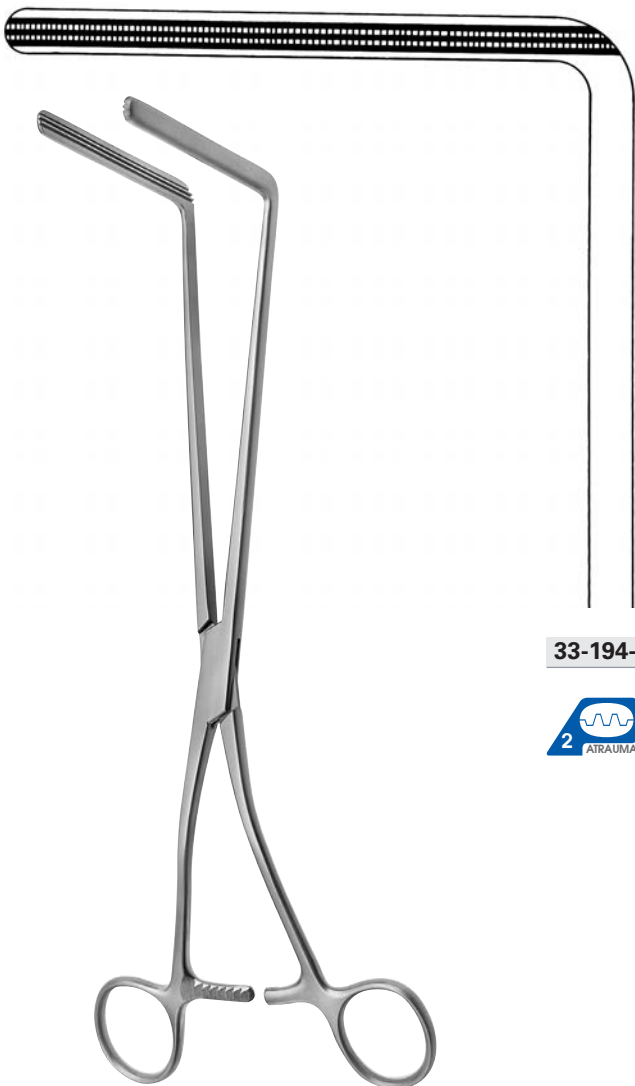

33-194-26



RESANO

33-194-26 26,5 cm, 10 1/2"



33-195-25



WERTHEIM

33-195-25 25,0 cm, 9 3/4"



STONE-WATT

33-196-07 8,5 cm, 3 1/3 "
33-196-10 10,0 cm, 4 "



Klemmschloß
Locking device
Cierre para clamps
Serratura per pinze

STONE-WATT

33-196-00

Schließklemme
Closing forceps
Pinza para cerrar clamps
Serrapinze e portapinze



STONE-WATT

33-196-15 15,5 cm, 6 1/8 "



komplett
complete
completo
completo

PETZ

33-200-00



Verpackungseinheit: 300 St.
Packing unit: 300 pieces
Unidad: 300 piezas
Confezione: 300 pezzi



33-200-20



SIMS-BODENHAMMER

33-300-15 15,5 cm, 6 1/8"



SIMS

33-302-15 15,5 cm, 6 1/8"



105 x 23 - 28 mm

CZERNY

33-305-22 22,5 cm, 9"



80 x 25 mm

PRATT

33-308-20 21,5 cm, 8 1/2"

Analspreizer
 Rectal retractor
 Separadores para el recto
 Dilatatori per l'ano ed il retto

70 x 22 mm



BARR

33-309-17 17,0 cm, 6 3/4"

90 x 15 mm



MATHIEU

33-312-21 21,0 cm, 8 1/4"

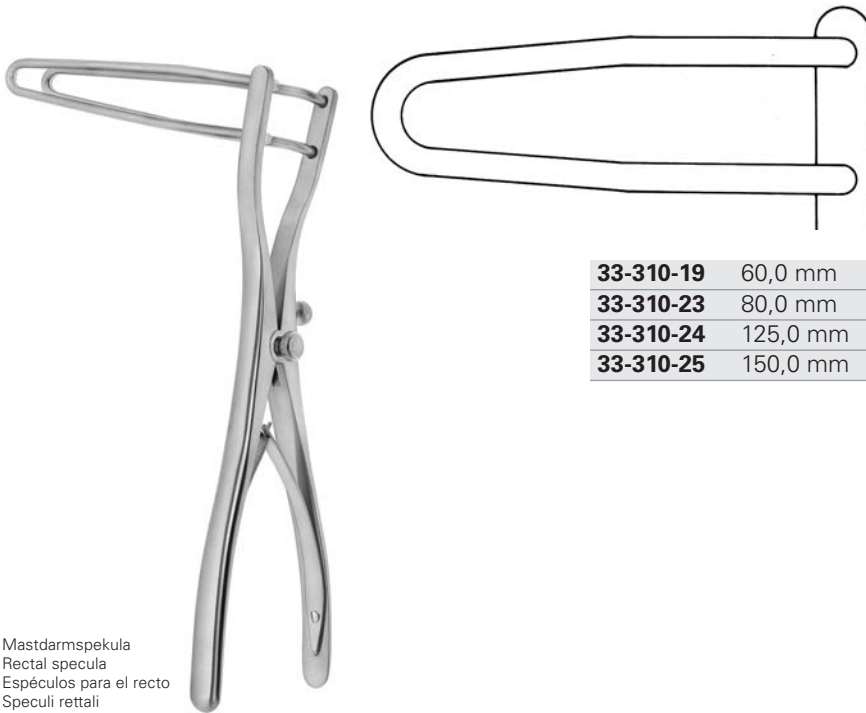

33-310-19	60,0 mm
33-310-23	80,0 mm
33-310-24	125,0 mm
33-310-25	150,0 mm

Mastdarmspekula
Rectal specula
Espéculos para el recto
Speculi rettali

SIMS

33-310-19	19,0 cm, 7 1/2"
33-310-23	23,5 cm, 9 1/4"
33-310-24	23,5 cm, 9 1/4"
33-310-25	24,5 cm, 9 2/3"



Proktoskope
Proctoscopes
Proctoscopios
Proctoscopi

CHELSEA

33-313-22	Ø 22 x 65 mm
33-313-30	Ø 30 x 65 mm



Anuskope
Anoscopes
Anoscopios
Anoscopi

BENSAUDE

33-314-20	Ø 19 x 70 mm
33-314-23	Ø 22 x 70 mm



Anuskope
Anoscopes
Anoscopios
Anoscopi

FANSLER

33-315-25	Ø 25 x 65 mm
33-315-29	Ø 29 x 65 mm
33-315-35	Ø 35 x 65 mm

Anuskope mit Kaltlichtaufsatz
 Anoscopes with fibre optic light carrier
 Anoscopios para adaptador luz fria
 Anoscopi per inserto a fibra ottica



AMNOTEC
 KARL STORZ
 OLYMPUS
 ACMI
 RICHARD WOLF



Anoskop
 Anoscopes
 Anoscopios
 Anoscopi



Anuskope
 Anoscopes
 Anoscopios
 Anoscopi

HIRSCHMANN

33-317-01	Ø 16 x 65 mm
33-317-02	Ø 19 x 65 mm
33-317-03	Ø 22 x 65 mm
33-317-04	Ø 25 x 125 mm

IVES-FANSLER

33-316-22 Ø 22 x 85 mm

IVES-FANSLER

33-316-24 Ø 22 x 85 mm



Sphinkteroskope
 Sphincteroscopes
 Esfinteroscopios
 Sfinteroscopi

KELLY

33-318-21 Ø 21 x 50 mm
33-320-27 Ø 27 x 50 mm

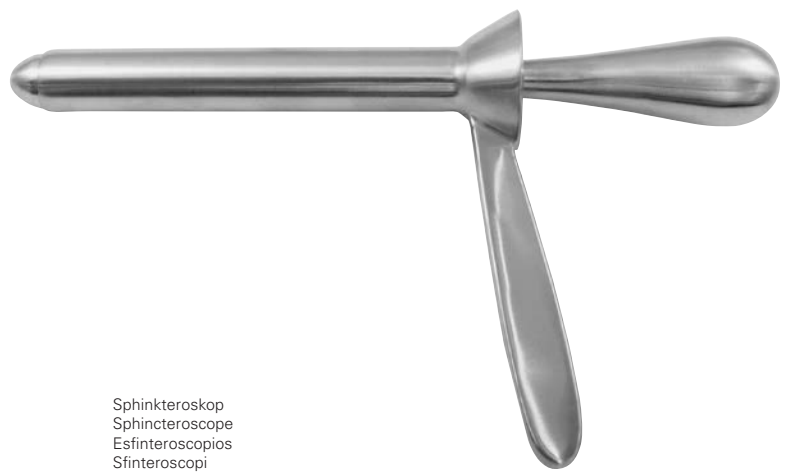

Sphinkteroskop
 Sphincteroscope
 Esfinteroscopios
 Sfinteroscopi

KELLY

33-322-22 Ø 22 x 140 mm

Proktoskope mit Kaltlichtaufsatz
Proctoscopes with fibre optic light carrier
Proctoscopios para adaptador luz fria
Proctoscopi per inserto a fibra ottica

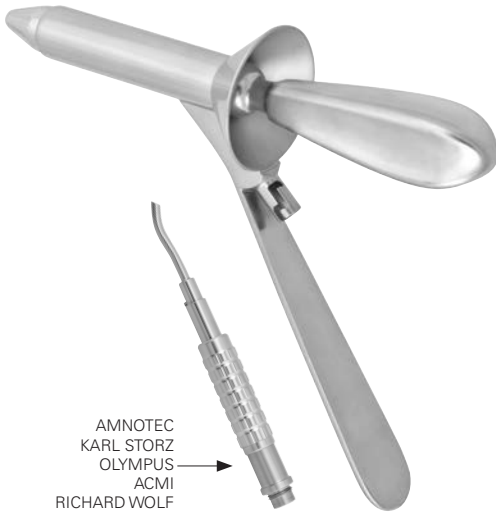

AMNOTEC
KARL STORZ
OLYMPUS
ACMI
RICHARD WOLF

Kaltlichtaufsatz
Fibre optic light carrier
Adaptador luz fria
Inserto a fibra ottica

AMNOTEC
KARL STORZ
OLYMPUS
ACMI
RICHARD WOLF

MORGAN

33-324-17	Ø 17 x 65 mm
33-324-18	Ø 17 x 80 mm
33-324-20	Ø 20 x 65 mm
33-324-21	Ø 20 x 80 mm
33-324-24	Ø 24 x 65 mm
33-324-25	Ø 24 x 80 mm

MORGAN

33-324-99



Aminoskope
Aminoscopes
Aminoscopio
Amnioscopio

33-326-12	Ø 12 x 200 mm
33-326-16	Ø 16 x 200 mm
33-326-20	Ø 20 x 200 mm

max. Spreizweite 110 mm
max. spread 110 mm
apertura máxima 110 mm
apertura massima 110 mm

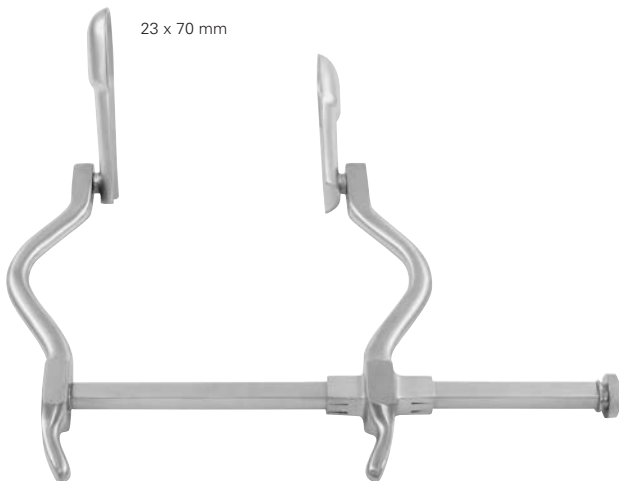

SMITH-BUIE

33-329-00 15,5 cm, 6 1/8"



ROSCHKE

33-331-00 Ø 15 - 30 mm



ALAN-PARKS

33-330-00 SET



Analspreizer komplett,
 bestehend aus:

1 Sperrer	33-330-01
1 Mittelvale 95 x 22 mm	33-330-02
1 Seitenvlaven 75 mm	33-330-03
1 Seitenvlaven 95 mm	33-330-04

Rectal retractor complete,
 consisting of:

1 Spreader	33-330-01
1 Central valve 95 x 22 mm	33-330-02
1 Lateral valves 75 mm	33-330-03
1 Lateral valves 95 mm	33-330-04

Separador para el recto,
 completo, compuesto de:

1 Separador	33-330-01
1 Valva central 95 x 22 mm	33-330-02
1 Valvas lateral 75 mm	33-330-03
1 Valvas lateral 95 mm	33-330-04

Dilatatore rettale, completo,
 compuesto da:

1 Divaricatore	33-330-01
1 Valva centrale 95 x 22mm	33-330-02
1 Valve laterale 75 mm	33-330-03
1 Valve laterale 95 mm	33-330-04

ALAN-PARKS

33-330-50 SET



Analspreizer komplett,
 bestehend aus:

1 Sperrer	33-330-01
1 Mittelvale 95 x 22 mm	33-330-02
1 Seitenvlaven 75 mm	33-330-03
1 Seitenvlaven 95 mm	33-330-04
1 Kaltlichtaufsatz	

Rectal retractor complete,
 consisting of:

1 Spreader	33-330-01
1 Central valve 95 x 22 mm	33-330-02
1 Lateral valves 75 mm	33-330-03
1 Lateral valves 95 mm	33-330-04
1 Cold light adaptor	

Separador para el recto
 completo, compuesto de:

1 Separador	33-330-01
1 Valva central 95 x 22 mm	33-330-02
1 Valvas lateral 75 mm	33-330-03
1 Valvas lateral 95 mm	33-330-04
1 Portador de luz fría	

Dilatatore rettale completo,
 compuesto da:

1 Divaricatore	33-330-01
1 Valva centrale 95 x 22mm	33-330-02
1 Valve laterale 75 mm	33-330-03
1 Valve laterale 95 mm	33-330-04
1 Supporto per luce fredda	

Seitenvlaven, paar
 Lateral vales, pair
 Valvas lateral, par
 Valve laterale, paio



ALAN-PARKS

33-330-03	75 x 22 mm
33-330-04	95 x 22 mm
33-330-06	90 x 22 mm



ST. MARKS

33-332-00 21,0 cm, 8 ¼"



biegsam
malleable
maleable
malleabile

33-340-19 19,0 cm, 7 ½"



Ø 3,0 mm

biegsam
malleable
maleable
malleabile

33-342-19 19,0 cm, 7 ½"



33-343-24 24,0 cm, 9 ½"

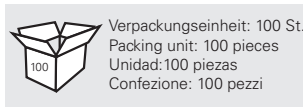

Verpackungseinheit: 100 St.
Packing unit: 100 pieces
Unidad: 100 piezas
Confezione: 100 pezzi

Ligatur-Gummiringe
Ligature rings
Anillos ligatura
Anelli per legature



33-350-99

Ladekonus, allein
 Loading cone, only
 Cono de carga, solo
 Cono per carica, solo



STEEL
 STAINLESS

33-350-98 Ø 12,0 mm



komplett mit Ladekonus 33-350-98
 complete with loading cone 33-350-98
 completo con cono de carga 33-350-98
 completo con cono per carica 33-350-98

RUDD

33-350-31 31,5 cm, 12 1/2"

Saugkopf, allein
 Suction head, only
 cono de carga, solo
 cono per carica, solo



STEEL
 STAINLESS

33-351-99 Ø 10,0 mm



Ladekonus, allein
 Loading cone, only
 Cono de carga, solo
 Cono per carica, solo



PE
 PLASTIC

33-351-95 Ø 10,0 mm

komplett mit Ladekonus und 1 Saugkopf
 complete with loading cone and 1 suction head
 completo con cono de carga y 1 cono de carga
 completo con cono per carica e 1 cono per carica

33-351-10

Ladekonus, allein
 Loading cone, only
 Cono de carga, solo
 Cono per carica, solo



PE
 PLASTIC

33-352-10

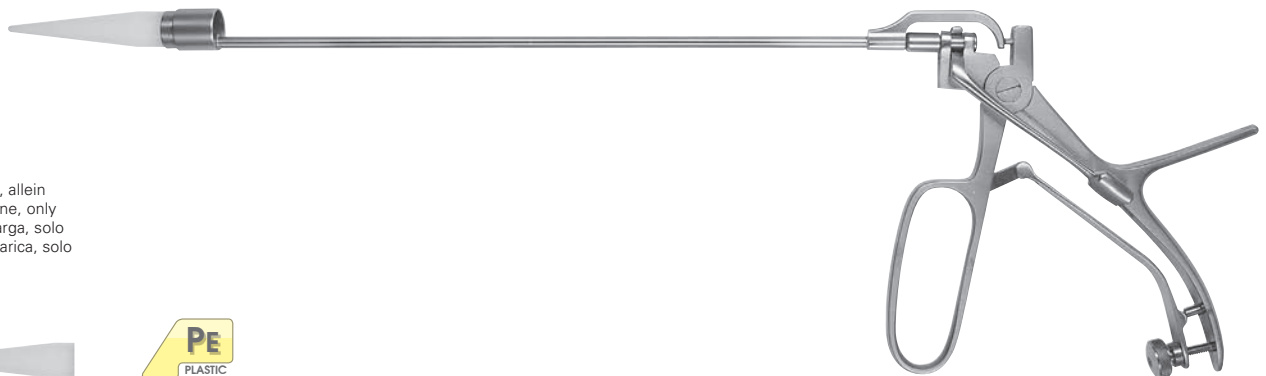

komplett mit Ladekonus 33-352-10
 complete with loading cone 33-352-10
 completo con cono de carga 33-352-10
 completo con cono per carica 33-352-10

BARRON

33-352-00

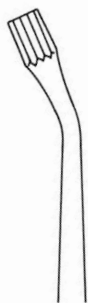

33-352-18

MC GIVNEY

33-352-18 18,5 cm, 7 1/4"

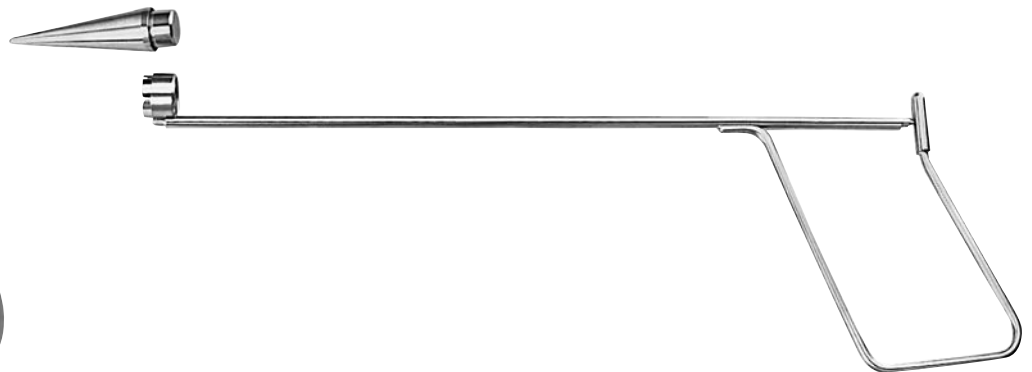

komplett mit Ladekonus Ø 12,0 mm
complete with loading cone Ø 12,0 mm
completo con cono de carga Ø 12,0 mm
completo con cono per carica Ø 12,0 mm

MC GIVNEY

33-353-00 17,5 cm, 7"

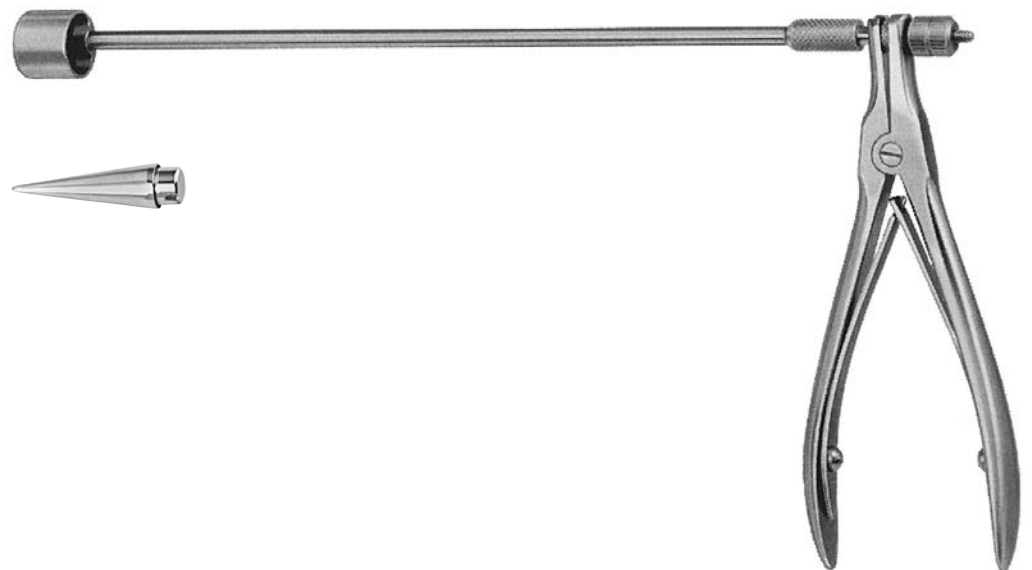

komplett mit Ladekonus
complete with loading cone
completo con cono de carga
completo con cono per carica

FORD-DIXON

33-354-00 25,0 cm, 9 3/4"

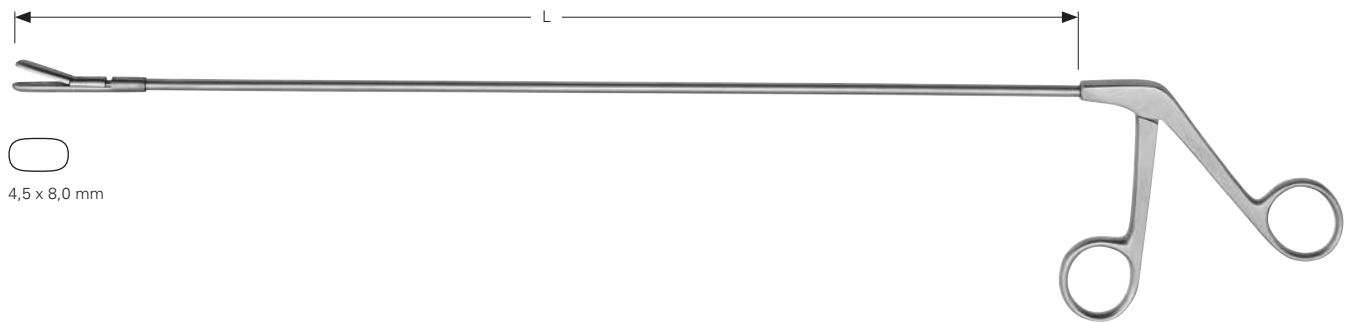

LLOYD-DAVIS

33-356-35 35,0 cm, 13³/₄ "

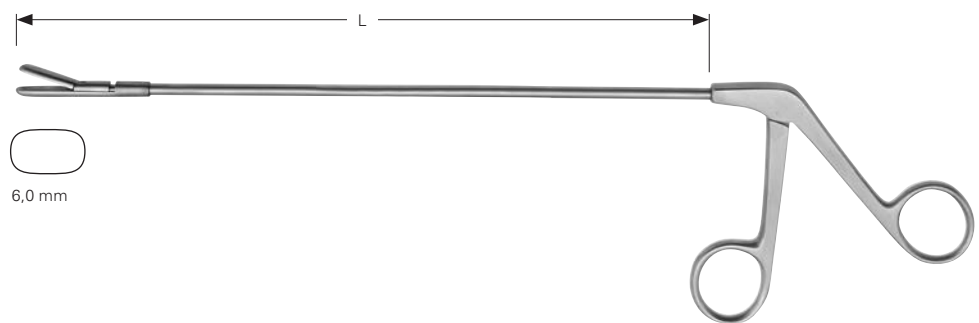

WALTON

33-358-20 20,0 cm, 8 "

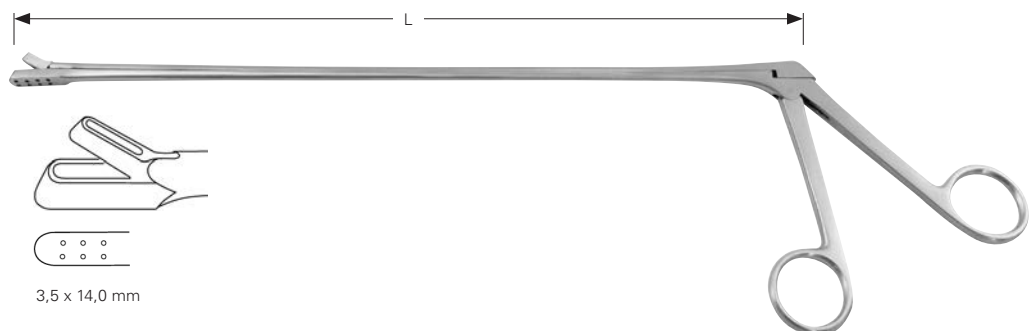

YEOMANN

33-362-28 28,0 cm, 11 "
33-362-35 35,0 cm, 13³/₄ "
33-362-42 42,0 cm, 16¹/₂ "



34



Leber, Galle, Niere

Liver, Gall bladder, Kidney

Hígado, Bilis, Riñón

Fegato, Biliari, Renali



Ø 1,0 mm
34-102-01

Ø 2,0 mm
34-102-02

Ø 3,0 mm
34-102-03

Ø 4,0 mm
34-102-04

Ø 5,0 mm
34-102-05

Ø 6,0 mm
34-102-06

Ø 7,0 mm
34-102-07

Ø 8,0 mm
34-102-08

Ø 9,0 mm
34-102-09

Ø 10,0 mm
34-102-10

Ø 11,0 mm
34-102-11

Ø 12,0 mm
34-102-12

Ø 13,0 mm
34-102-13

biegsamer Schaft
malleable shaft
västago maleable
gambo malleabile

BAKES

34-102-01 - 34-102-13 31,0 cm, 12 ¼"

BAKES

34-101-99 31,0 cm, 12 ¼"

Set 34-102-03 - 34-102-11

BAKES

34-102-00 31,0 cm, 12 ¼"

Set 34-101-01 - 34-101-13

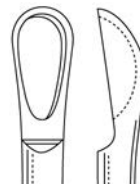

Fig. 1 | 4,2 mm
34-104-01

Fig. 2 | 6,0 mm
34-104-02

Fig. 3 | 7,0 mm
34-104-03

federnd
flexible
flexible
flessibile



34-105-36

Ø 5,0 mm

biegsam
malleable
maleable
malleabile

DESJARDINS

34-104-01 - 34-104-03 28,0 cm, 11"

MOYNIHAN

34-105-36 36,0 cm, 14 ¼"



federnd
flexible
flexible
flexible
flessibile

OCHSNER

34-106-35 35,0 cm, 13 3/4"



federnd
flexible
flexible
flexible
flessibile

DESJARDINS

34-118-01 - 34-118-04 30,0 cm, 11 3/4"



6,0 mm

34-118-01



7,0 mm

34-118-02



8,0 mm

34-118-03



9,0 mm

34-118-04



biegsam
malleable
malleable
malleable
malleabile

LUER-KOERTE

34-120-01 - 34-120-08 31,0 cm, 12 1/4"



Fig. 000

34-120-01



Fig. 00

34-120-02



Fig. 0

34-120-03



Fig. 1

34-120-04



Fig. 2

34-120-05



Fig. 3

34-120-06



Fig. 4

34-120-07



Fig. 5

34-120-08

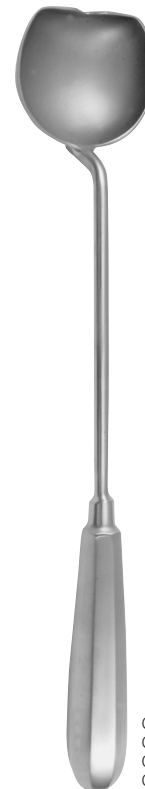

Gallenblasenlöffel
Gall bladder scoop
Cucharilla para la vesicula biliar
Cucchiario per colecisti

MOORE

34-130-28 30,0 cm, 11 3/4"



MAYO

34-132-28 28,0 cm, 11 "



Fig. 1

34-134-01



Fig. 2

34-134-02



Fig. 3

34-134-03



FERGUSSON

34-134-01 - 34-134-03 22,0 cm, 8 3/4 "



MAYO

34-136-01 - 34-136-03 27,0 cm, 10 3/4 "



4,0 mm

34-136-01



5,0 mm

34-136-02



6,0 mm

34-136-03



HEIMING

34-201-16 16,0 cm, 6 1/4 "

34-201-17 17,0 cm, 6 3/4 "

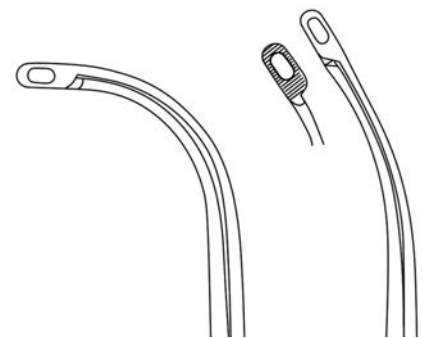

34-201-16

34-201-17

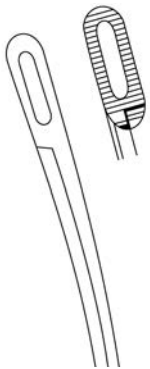

Fig. 1

34-207-01

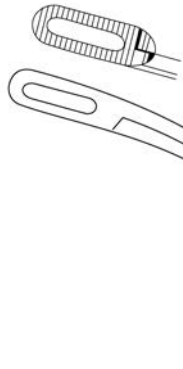

Fig. 2

34-207-02

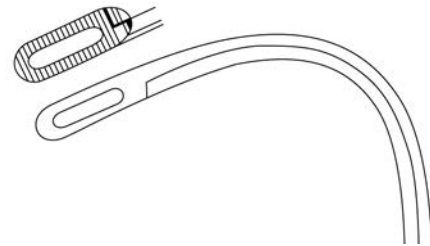

Fig. 3

34-207-03

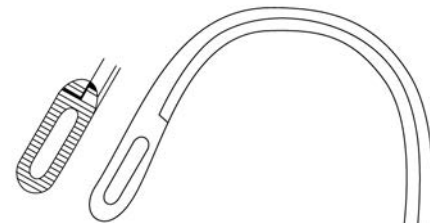

Fig. 4

34-207-04

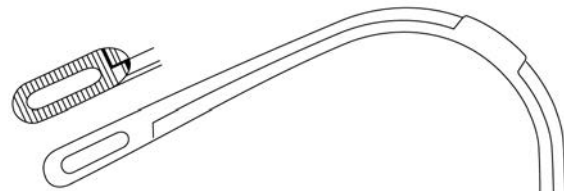

Fig. 5

34-209-05

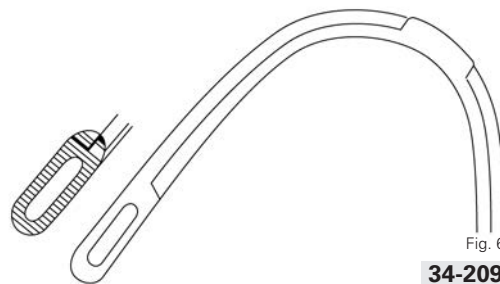
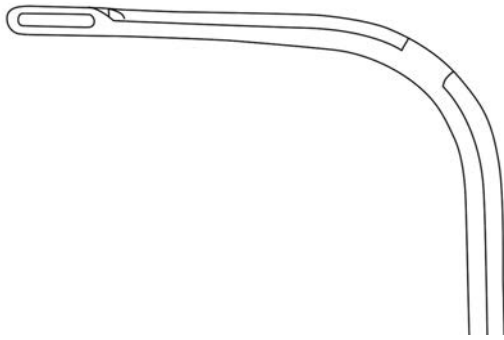
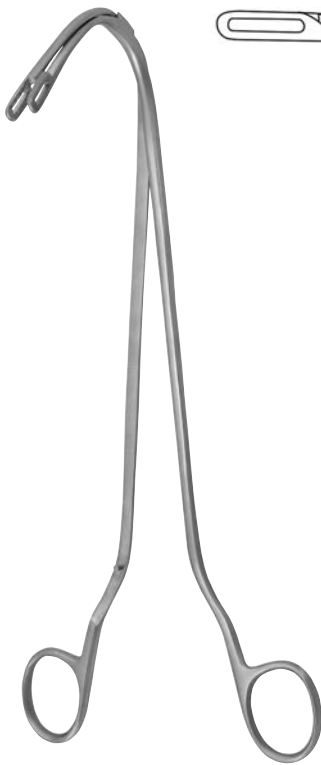

Fig. 6

34-209-06

RANDALL

34-207-01	23,0 cm, 9 "
34-207-02 - 34-207-04	22,0 cm, 8 3/4 "
34-209-05 - 34-209-06	19,0 cm, 7 1/2 "



34-211-01

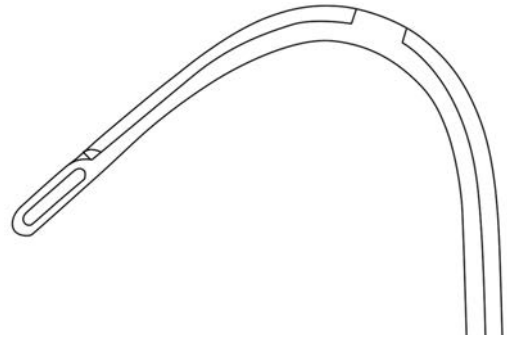

34-211-02

RANDALL

34-211-01	24,5 cm, 9 3/4"
34-211-02	23,0 cm, 9"

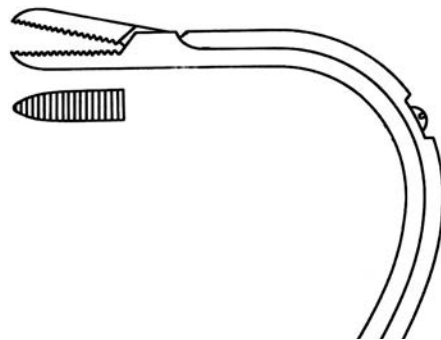

34-215-01

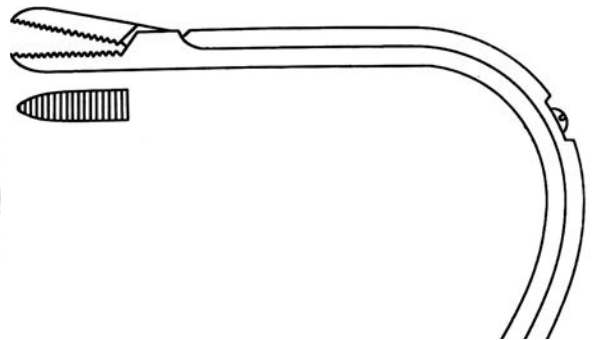

34-215-02

ELSAESSER

34-215-01 - 34-215-02	21,0 cm, 8 1/4"
-----------------------	-----------------

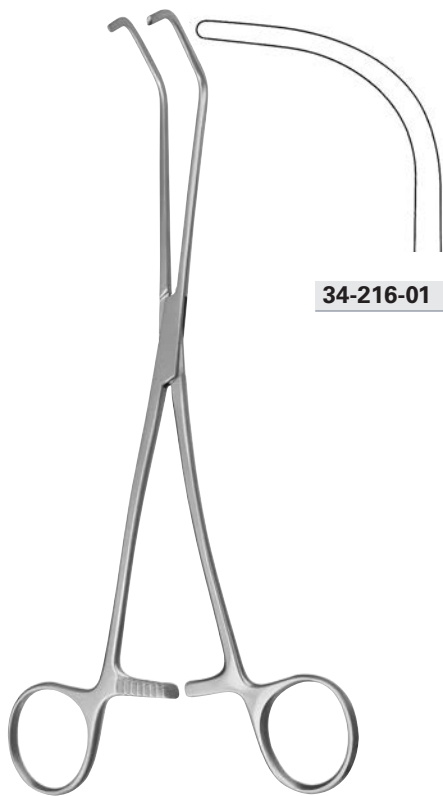

34-216-01

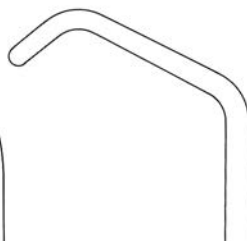

34-216-02

LURZ

34-216-01 - 34-216-02 21,0 cm, 8 ¼"



34-240-20



34-241-20

BLAKE

34-240-20 - 34-241-20 20,0 cm, 8"



34-244-20

MAYO-BLAKE

34-244-20 20,0 cm, 8"



34-245-20

MAYO-BLAKE

34-245-20 20,0 cm, 8"



34-247-22

MIXTER

34-247-22 22,0 cm, 8 3/4"



34-249-01



34-249-02

DESJARDINS

34-249-01 - 34-249-02 23,0 cm, 8 1/4"



34-249-11



34-249-12

sehr schlankes Modell
very slender pattern
modelo muy delgado
modello molto delicato

DESJARDINS

34-249-11 - 34-249-12 23,0 cm, 8 1/4"



TUEBINGEN

34-251-26 26,0 cm, 10 1/4"



STILLE

34-253-24 24,5 cm, 9 2/3"



35



Gynäkologie, Geburtshilfe

Gynaecology, Obstetrics

Ginecologia, Ostetricia

Ginecologia, Ostetricia

für Kinder
for children
para niños
per bambini



COLLIN

35-000-01 55 x 10 mm

für Jungfrauen
for virgins
para vírgenes
per vergini



COLLIN

35-001-01 65 x 20 mm

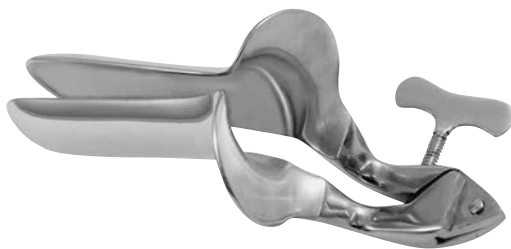

COLLIN

35-002-01 85 x 30 mm
35-002-02 100 x 35 mm
35-002-03 110 x 40 mm



seitliche Stellschraube
lateral fixation screw
tornillo de sujeto lateral
vite di regolazione laterale

CUSCO

35-003-01 75 x 17 mm



zentrale Stellschraube
 central fixation screw
 tornillo de sujeto central
 vite di regolazione centrale

CUSCO

35-004-01 75 x 17 mm



seitliche Stellschraube
 lateral fixation screw
 tornillo de sujeto lateral
 vite di regolazione laterale

CUSCO STANDARD

35-005-00 80 x 24 mm

35-005-01 75 x 32 mm

35-005-02 85 x 35 mm

35-005-03 110 x 37 mm

Schweizer Modell
 Swiss pattern
 Modelo suizo
 Modello svizzero



zentrale Stellschraube
 central fixation screw
 tornillo de sujeto central
 vite di regolazione centrale

CUSCO

35-006-01 75 x 32 mm

35-006-02 85 x 35 mm

35-006-03 100 x 37 mm



seitliche Stellschraube
 lateral fixation screw
 tornillo de sujeto lateral
 vite di regolazione laterale

CUSCO

35-007-01 80 x 22 mm

35-007-02 100 x 25 mm

35-007-03 105 x 27 mm



seitliche Stellschraube
lateral fixation screw
tornillo de sujeto lateral
vite di regolazione laterale

CUSCO

35-007-11	80 x 32 mm
35-007-12	90 x 37 mm
35-007-13	115 x 37 mm



SEMM

35-008-01	90x14 18 mm
35-008-02	100x17 20 mm
35-008-03	100x25 30 mm



SEYFFERT

35-009-01	100 x 17 mm
35-009-02	110 x 33 mm



TRELAT

35-010-01	85 x 33 mm
35-010-02	95 x 35 mm
35-010-03	115 x 43 mm



NOTT

35-011-01	90 x 30 mm
35-011-02	110 x 30 mm



seitliche Stellschraube
lateral fixation screw
tornillo de sujeto lateral
vite di regolazione laterale

GRAVE

35-013-01	75 x 20 mm
35-013-02	95 x 35 mm
35-013-03	115 x 35 mm



seitliche Stellschraube
lateral fixation screw
tornillo de sujeto lateral
vite di regolazione laterale

PEDERSON

35-014-01	75 x 13 mm
35-014-02	100 x 22 mm
35-014-03	120 x 25 mm

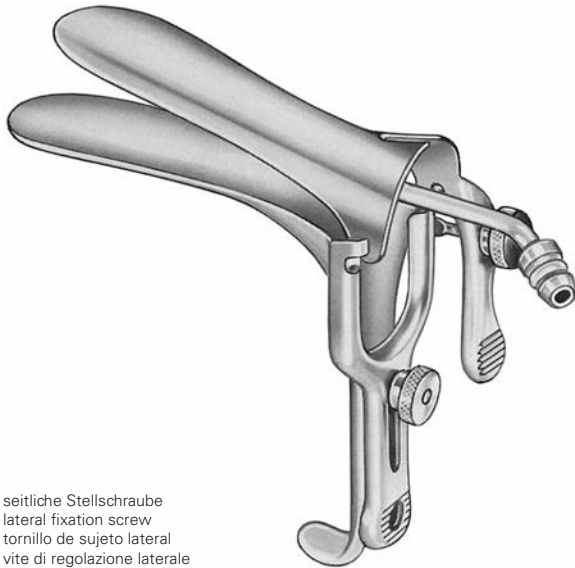

seitliche Stellschraube
lateral fixation screw
tornillo de sujeto lateral
vite di regolazione laterale

GRAVE

35-017-01 - 35-017-23

GRAVE

35-017-01	76 x 19 mm
35-017-02	101 x 35 mm
35-017-03	120 x 35 mm

Absaugung am oberen Blatt
Suction tube on upper blade
Tubo de succión a la valva superior
Canula d'aspirazione alla valva superiore

GRAVE

35-017-11	76 x 19 mm
35-017-12	101 x 35 mm
35-017-13	120 x 35 mm

Absaugung am unteren Blatt
Suction tube on lower blade
Tubo de succión a la valva inferior
Canula d'aspirazione alla valva inferiore

GRAVE

35-017-21	76 x 19 mm
35-017-22	101 x 35 mm
35-017-23	120 x 35 mm

Absaugung am oberen und unteren Blatt
Suction tube on upper and lower blade
Tubo de succión a la valva superior y inferior
Canula d'aspirazione alla valva superiore e inferiore

Absaugung am oberen Blatt
Suction tube on upper blade
Tubo de succión a la valva superior
Canula d'aspirazione alla valva superiore



seitliche Stellschraube
lateral fixation screw
tornillo de sujeto lateral
vite di regolazione laterale



GRAVE

35-017-01 B	76 x 19 mm
35-017-02 B	101 x 35 mm
35-017-03 B	120 x 35 mm

Absaugung am oberen Blatt, isoliert
Suction tube on upper blade, insulated
Tubo de succión a la valva superior, aislado
Canula d'aspirazione alla valva superiore, isolato



seitliche Stellschraube
lateral fixation screw
tornillo de sujeto lateral
vite di regolazione laterale

GRAVE

35-017-01 BL	76 x 19 mm
35-017-02 BL	101 x 35 mm
35-017-03 BL	120 x 35 mm

PEDERSON

35-017-51	76 x 13 mm
35-017-52	101 x 22 mm
35-017-53	120 x 25 mm

Absaugung am oberen Blatt
Suction tube on upper blade
Tubo de succión a la valva superior
Canula d'aspirazione alla valva superiore

PEDERSON

35-017-61	76 x 13 mm
35-017-62	101 x 22 mm
35-017-63	120 x 25 mm

Absaugung am unteren Blatt
Suction tube on lower blade
Tubo de succión a la valva inferior
Canula d'aspirazione alla valva inferiore

PEDERSON

35-017-71	76 x 13 mm
35-017-72	101 x 22 mm
35-017-73	120 x 25 mm

Absaugung am oberen und unteren Blatt
Suction tube on upper and lower blade
Tubo de succión a la valva superior y inferior
Canula d'aspirazione alla valva superiore e inferiore

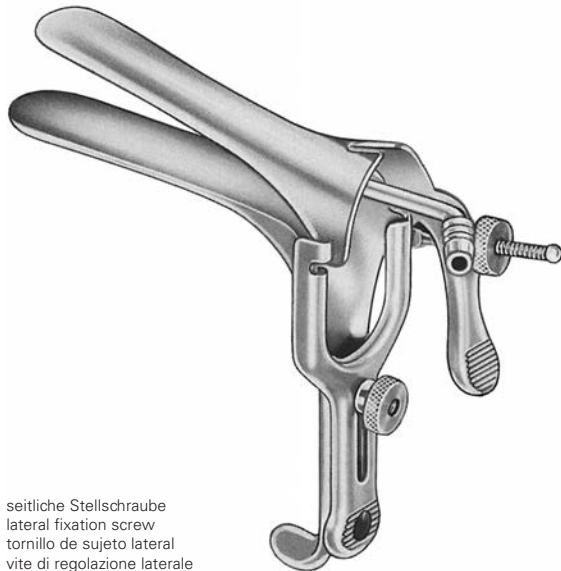

seitliche Stellschraube
lateral fixation screw
tornillo de sujeto lateral
vite di regolazione laterale

PEDERSON

35-017-51 - 35-017-73

Absaugung am oberen Blatt
Suction tube on upper blade
Tubo de succión a la valva superior
Canula d'aspirazione alla valva superiore



seitliche Stellschraube
lateral fixation screw
tornillo de sujeto lateral
vite di regolazione laterale



PEDERSON

35-017-51 B	76 x 13 mm
35-017-52 B	101 x 22 mm
35-017-53 B	120 x 25 mm

Absaugung am oberen Blatt, isoliert
Suction tube on upper blade, insulated
Tubo de succión a la valva superior, aislado
Canula d'aspirazione alla valva superiore, isolato



seitliche Stellschraube
lateral fixation screw
tornillo de sujeto lateral
vite di regolazione laterale

PEDERSON

35-017-51 BL	76 x 13 mm
35-017-52 BL	101 x 22 mm
35-017-53 BL	120 x 25 mm

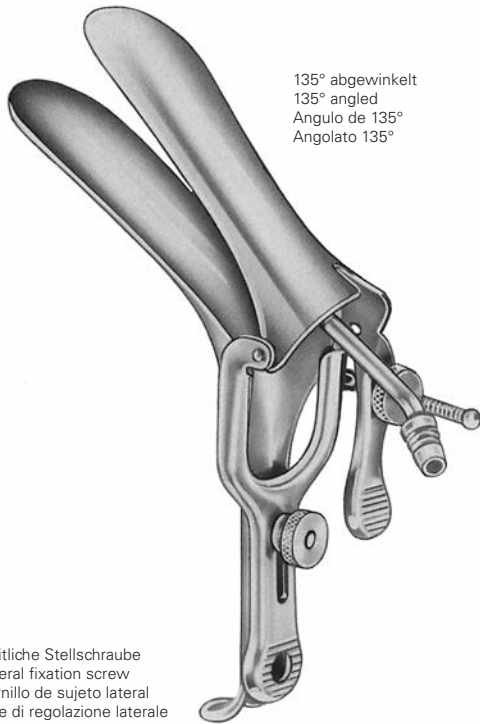

135° abgewinkelt
135° angled
Angulo de 135°
Angolato 135°

seitliche Stellschraube
lateral fixation screw
tornillo de sujeto lateral
vite di regolazione laterale

GRAVE SPECIAL

35-018-01 - 35-018-03

GRAVE SPECIAL

35-018-01 101 x 35 mm

Absaugung am oberen Blatt
Suction tube on upper blade
Tubo de succión a la valva superior
Canula d'aspirazione alla valva superiore

GRAVE SPECIAL

35-018-02 101 x 35 mm

Absaugung am unteren Blatt
Suction tube on lower blade
Tubo de succión a la valva inferior
Canula d'aspirazione alla valva inferiore

GRAVE SPECIAL

35-018-03 101 x 35 mm

Absaugung am oberen und unteren Blatt
Suction tube on upper and lower blade
Tubo de succión a la valva superior y inferior
Canula d'aspirazione alla valva superiore e inferiore

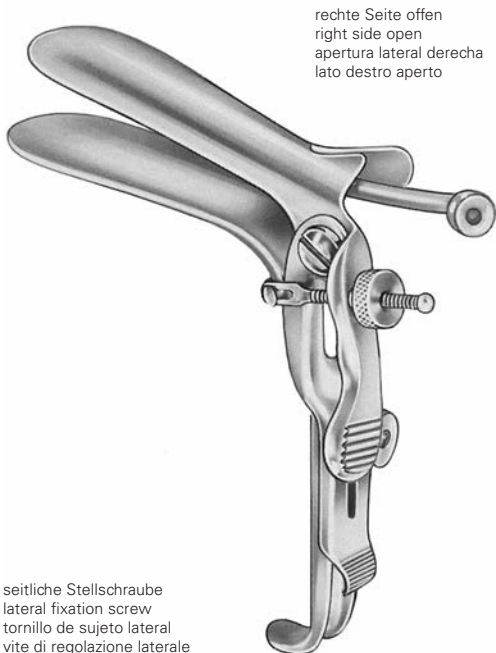

rechte Seite offen
right side open
apertura lateral derecha
lato destro aperto

seitliche Stellschraube
lateral fixation screw
tornillo de sujeto lateral
vite di regolazione laterale

GRAVE SPECIAL

35-018-11 - 35-018-13

GRAVE SPECIAL

35-018-11 101 x 35 mm

Absaugung am oberen Blatt
Suction tube on upper blade
Tubo de succión a la valva superior
Canula d'aspirazione alla valva superiore

GRAVE SPECIAL

35-018-12 101 x 35 mm

Absaugung am unteren Blatt
Suction tube on lower blade
Tubo de succión a la valva inferior
Canula d'aspirazione alla valva inferiore

GRAVE SPECIAL

35-018-13 101 x 35 mm

Absaugung am oberen und unteren Blatt
Suction tube on upper and lower blade
Tubo de succión a la valva superior y inferior
Canula d'aspirazione alla valva superiore e inferiore

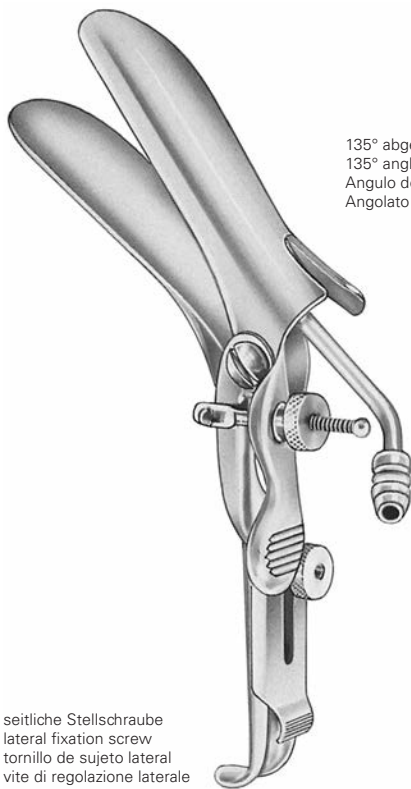

135° abgewinkelt, rechte Seite offen
135° angled, right side open
Angulo de 135°, apertura lateral derecha
Angolato 135°, lato destro aperto

seitliche Stellschraube
lateral fixation screw
tornillo de sujeto lateral
vite di regolazione laterale

GRAVE SPECIAL

35-018-21 - 35-018-23

GRAVE SPECIAL

35-018-21 101 x 35 mm

Absaugung am oberen Blatt
Suction tube on upper blade
Tubo de succión a la valva superior
Canula d'aspirazione alla valva superiore

GRAVE SPECIAL

35-018-22 101 x 35 mm

Absaugung am unteren Blatt
Suction tube on lower blade
Tubo de succión a la valva inferior
Canula d'aspirazione alla valva inferiore

GRAVE SPECIAL

35-018-23 101 x 35 mm

Absaugung am oberen und unteren Blatt
Suction tube on upper and lower blade
Tubo de succión a la valva superior y inferior
Canula d'aspirazione alla valva superiore e inferiore



SIMS

35-019-01 70x30 | 65x25
35-019-02 70x35 | 70x30
35-019-03 90x40 | 85x35



Spekulum und Halter
Speculum and retractor
Espéculo y valva
Speculo e valva

SEIDL

35-020-01 80 x 8 mm
35-020-02 80 x 10 mm
35-020-03 90 x 14 mm



60 x 22 mm
35-021-25

STEEL
STAINLESS

72 x 22 mm
35-021-31

STEEL
STAINLESS

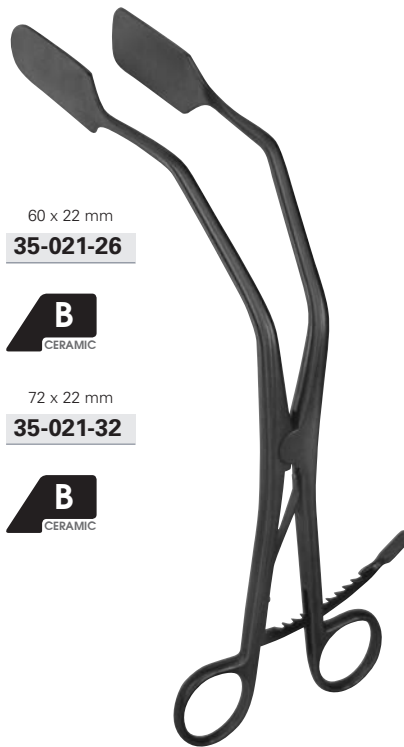

60 x 22 mm
35-021-26

B
CERAMIC

72 x 22 mm
35-021-32

B
CERAMIC

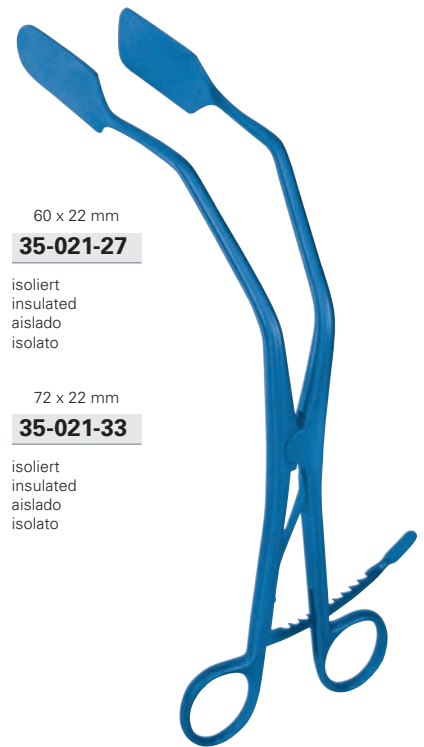

60 x 22 mm
35-021-27

isoliert
insulated
aislado
isolato

72 x 22 mm
35-021-33

isoliert
insulated
aislado
isolato

35-021-25	25,0 cm, 9 3/4"
35-021-31	31,0 cm, 12 1/4"

35-021-26	25,0 cm, 9 3/4"
35-021-32	31,0 cm, 12 1/4"

35-021-27	25,0 cm, 9 3/4"
35-021-33	31,0 cm, 12 1/4"



60 x 22 mm
35-022-01

STEEL
STAINLESS

72 x 22 mm
35-022-11

STEEL
STAINLESS

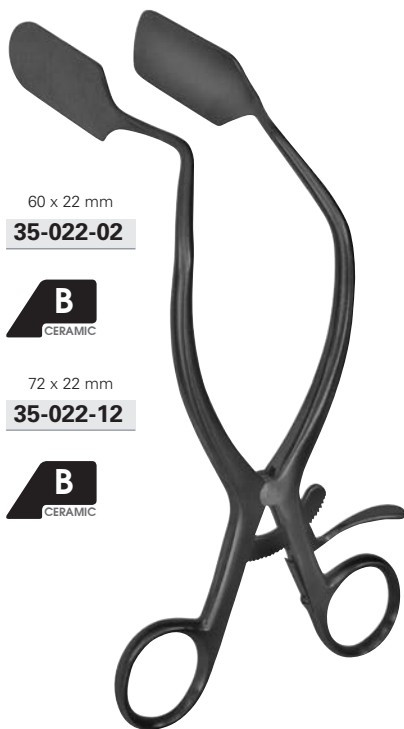

60 x 22 mm
35-022-02

B
CERAMIC

72 x 22 mm
35-022-12

B
CERAMIC

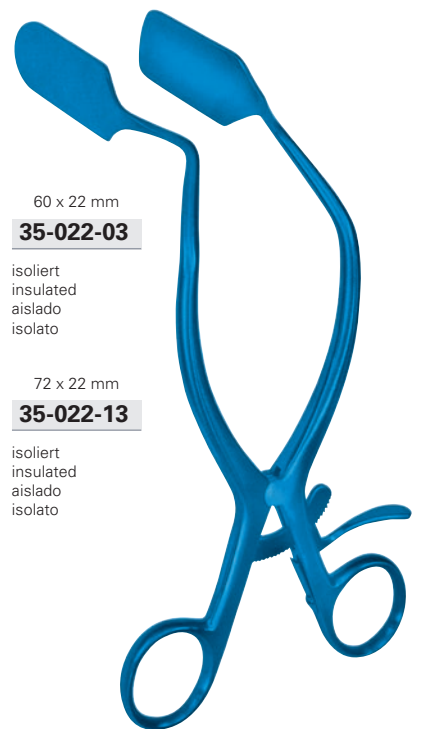

60 x 22 mm
35-022-03

isoliert
insulated
aislado
isolato

72 x 22 mm
35-022-13

isoliert
insulated
aislado
isolato

35-022-01	25,0 cm, 9 3/4"
35-022-11	31,0 cm, 12 1/4"

35-022-02	25,0 cm, 9 3/4"
35-022-12	31,0 cm, 12 1/4"

35-022-03	25,0 cm, 9 3/4"
35-022-13	31,0 cm, 12 1/4"

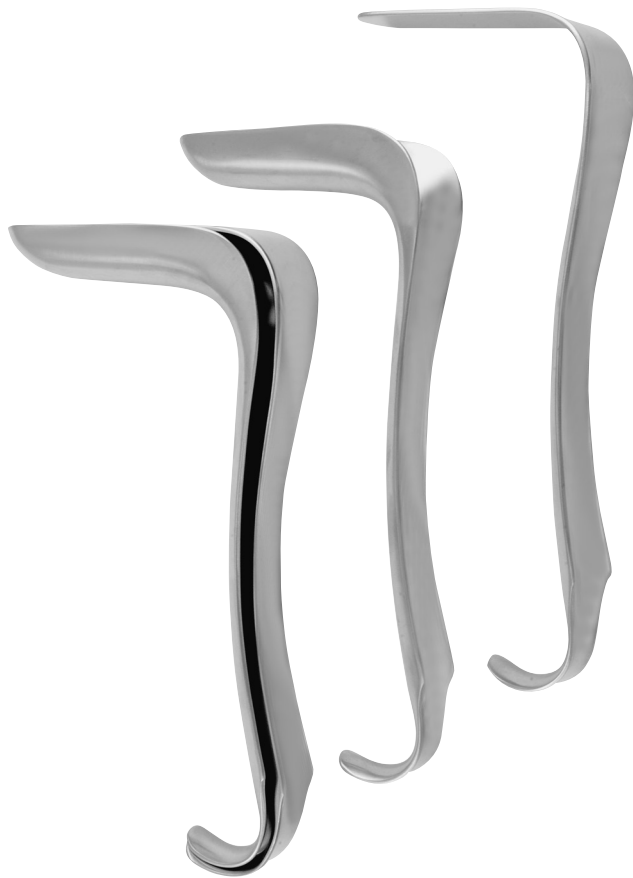

KRISTELLER

35-030-00	Fig. 0
35-030-01	Fig. 1
35-030-02	Fig. 2
35-030-03	Fig. 3

Satz
Set
Juego
Set

KRISTELLER

35-031-00	70 x 15 mm
35-031-01	70 x 27 mm
35-031-02	80 x 30 mm
35-031-03	90 x 36 mm

Spekula allein
Specula only
Espéculos suelto
Solo speculi

KRISTELLER

35-032-00	70 x 15 mm
35-032-01	75 x 23 mm
35-032-02	85 x 26 mm
35-032-03	100 x 32 mm

Halter allein
Retractor only
Valvas suelto
Solo valve

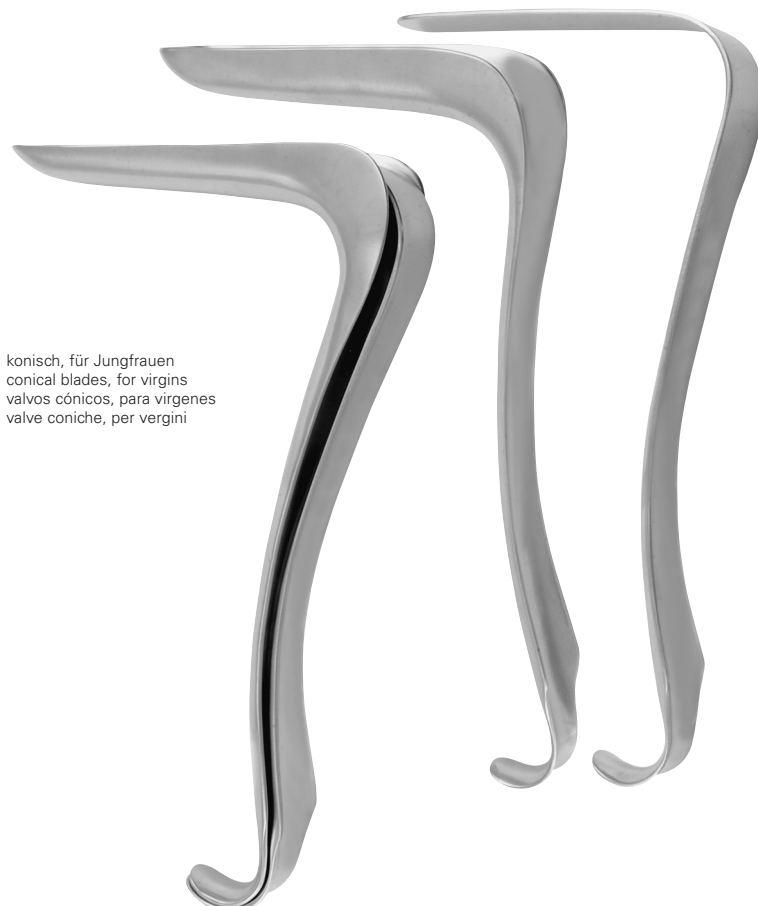

konisch, für Jungfrauen
conical blades, for virgins
valvos cónicos, para vírgenes
valve coniche, per vergini

KRISTELLER

35-040-01	Fig. 00
35-040-02	Fig. 0

Satz
Set
Juego
Set

KRISTELLER

35-041-01	105 x 18 mm
35-041-02	105 x 21 mm

Spekula allein
Specula only
Espéculos suelto
Solo speculi

KRISTELLER

35-042-01	110 x 14 mm
35-042-02	110 x 17 mm

Halter allein
Retractor only
Valvas suelto
Solo valve



KRISTELLER

35-050-01	Fig. 1
35-050-02	Fig. 2
35-050-03	Fig. 3

Satz
Set
Juego
Set

KRISTELLER

35-051-01	110 x 27 mm
35-051-02	110 x 30 mm
35-051-03	110 x 36 mm

Spekula allein, tief
Specula only, deep
Espéculos suelto, con huecos profunes
Solo speculi, profonda

KRISTELLER

35-052-01	115 x 23 mm
35-052-02	115 x 26 mm
35-052-03	115 x 32 mm

Halter allein
Retractor only
Valvas suelto
Solo valve



KRISTELLER

35-060-01	Fig. 1
35-060-02	Fig. 2
35-060-03	Fig. 3

Satz
Set
Juego
Set

KRISTELLER

35-061-01	105 x 26 mm
35-061-02	105 x 28 mm
35-061-03	105 x 33 mm

Spekula allein, flach
Specula only, flat
Espéculos suelto, con huecos planos
Solo speculi, piatta

KRISTELLER

35-062-01	115 x 22 mm
35-062-02	115 x 24 mm
35-062-03	115 x 29 mm

Halter allein
Retractor only
Valvas suelto
Solo valve



KRISTELLER MOD. WIEN

35-064-01 Fig. 1

35-064-02 Fig. 2

35-064-03 Fig. 3

Satz
Set
Juego
Set

KRISTELLER MOD. WIEN

35-065-01 110 x 20 mm

35-065-02 110 x 30 mm

35-065-03 110 x 36 mm

Spekula allein
Specula only
Espéculos suelto
Solo speculi

KRISTELLER MOD. WIEN

35-066-01 115 x 18 mm

35-066-02 115 x 26 mm

35-066-03 115 x 32 mm

Halter allein
Retractor only
Valvas suelto
Solo valve

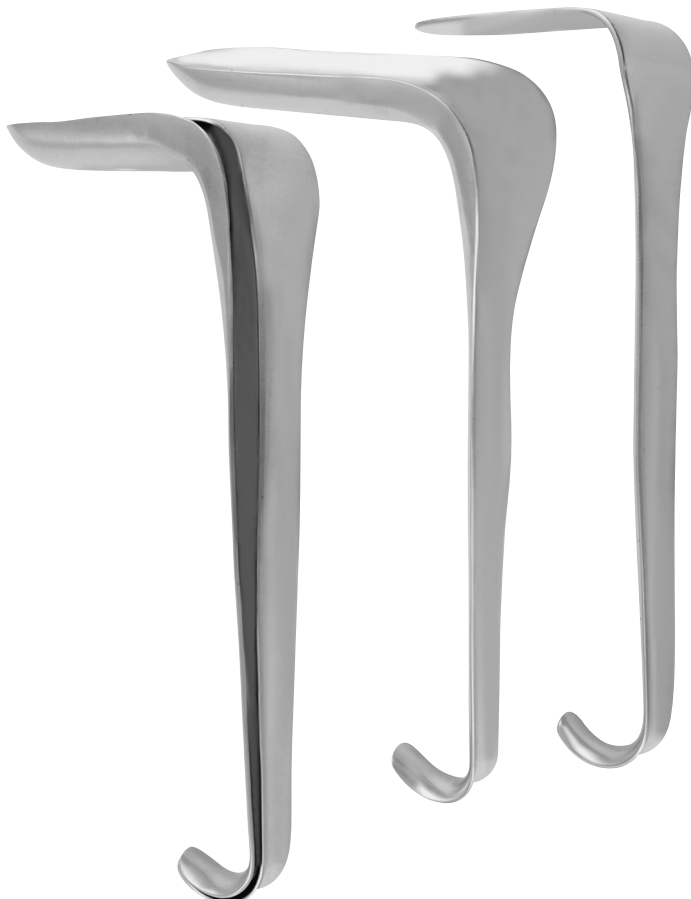

KALLMORGEN

35-070-01 Fig. 1

35-070-02 Fig. 2

Satz
Set
Juego
Set

KALLMORGEN

35-070-11 70 x 40 mm

35-070-12 90 x 40 mm

Spekula allein, flach
Specula only, flat
Espéculos suelto, con huecos planos
Solo speculi, piatta

KALLMORGEN

35-070-21 70 x 33 mm

35-070-22 90 x 33 mm

Halter allein
Retractor only
Valvas suelto
Solo valve



MATZENAUER

35-073-01	90 x 20 mm
35-073-02	100 x 10 mm
35-073-03	100 x 15 mm
35-073-04	100 x 20 mm
35-073-05	100 x 25 mm

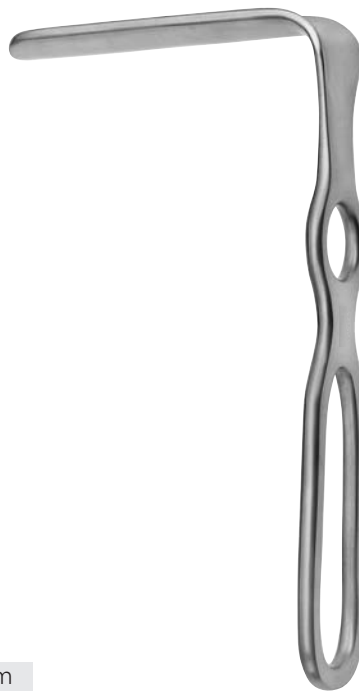

MATZENAUER

35-074-01	130 x 20 mm
35-074-02	130 x 25 mm
35-074-03	130 x 30 mm
35-074-04	130 x 35 mm
35-074-05	130 x 40 mm



LANDON

35-078-01	89 x 25 mm
------------------	------------

BRAUN

35-079-01	56 x 13 mm
------------------	------------



BRAUN

35-079-02	60 x 10 mm
------------------	------------



Spekula allein
Specula only
Espéculos suelto
Solo speculi

MATHIEU

35-080-01	95 x 17-30 mm
------------------	---------------



Halter allein
Retractor only
Valvas suelto
Solo valve

MATHIEU

35-080-02	95 x 17-26 mm
------------------	---------------



DOYEN

35-081-01	60 x 45 mm
35-081-02	90 x 45 mm
35-081-03	112 x 45 mm



DOYEN

35-081-60	60 x 30 mm
35-081-70	70 x 30 mm
35-081-80	80 x 30 mm



JACKSON

35-085-01	75 x 35 mm
35-085-02	90 x 35 mm
35-085-03	100 x 35 mm

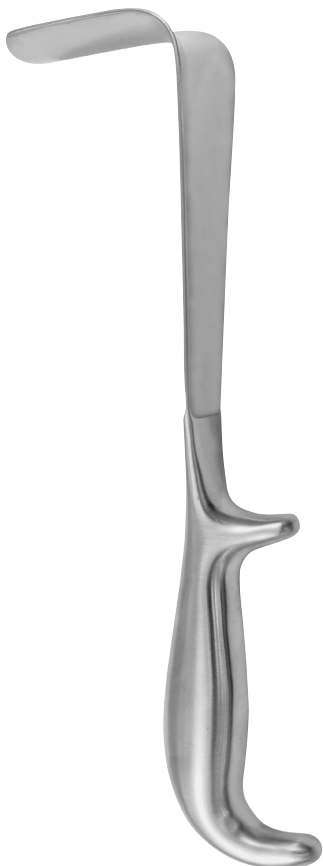

DOYEN

35-082-01	55 x 35 mm
35-082-02	85 x 35 mm
35-082-03	115 x 35 mm

DOYEN

35-083-01	55 x 45 mm
35-083-02	85 x 45 mm
35-083-03	115 x 45 mm
35-083-04	160 x 45 mm

DOYEN

35-084-01	55 x 60 mm
35-084-02	85 x 60 mm
35-084-03	115 x 60 mm
35-084-04	160 x 60 mm



LANDAU

35-086-28	100 x 28 mm
35-086-38	100 x 38 mm



BREISKY

35-087-15	100 x 15 mm
35-087-20	100 x 20 mm
35-087-25	100 x 25 mm
35-087-30	100 x 30 mm
35-087-35	100 x 35 mm
35-087-40	100 x 40 mm



BREISKY MOD. WIEN

35-088-20	130 x 20 mm
35-088-25	130 x 25 mm
35-088-30	130 x 30 mm
35-088-35	130 x 35 mm
35-088-40	130 x 40 mm
35-089-40	160 x 40 mm
35-090-40	180 x 40 mm



SCHERBACK

35-091-00 SET

Satz, komplett mit 5 Valven 35-092-01 – 35-092-05 und Griff
Set, complete with 5 valves 35-092-01 – 35-092-05 and handle
Juego, completo con 5 valvas 35-092-01 – 35-092-05 y mango
Set, completo con 5 valvas 35-092-01 – 35-092-05 e manico

SCHERBACK

35-092-00 SET

Satz, komplett mit 4 Valven 35-092-01 – 35-092-04 und Griff
Set, complete with 4 valves 35-092-01 – 35-092-04 and handle
Juego, completo con 4 valvas 35-092-01 – 35-092-04 y mango
Set, completo con 4 valvas 35-092-01 – 35-092-04 e manico

35-092-12

Griff
Handle
Mango
Manico



80 x 30 mm

35-092-01



85 x 35 mm

35-092-02



90 x 40 mm

35-092-03



55 x 40 | 60 mm

35-092-04



70 X 45 | 70 mm

35-092-05

35-092-10 400,0 g

35-092-11 800,0 g

Gewicht
Weight
Peso
Peso



mit festem Gewicht
with fixed weight
con peso fijo
con peso fisso

AUVARD

35-093-00 83 x 38 mm



mit abnehmbarem Gewicht
with detachable weight
con peso desmontable
con peso smontabile

AUVARD

35-093-01 80 x 38 mm

35-093-02 102 x 45 mm



35-094-99

abnehmbares Auffangsieb
removable colander
tamiz desmontable
filtro smontabile e fondo forato

WEISSBARTH

35-094-00 80 x 42 mm

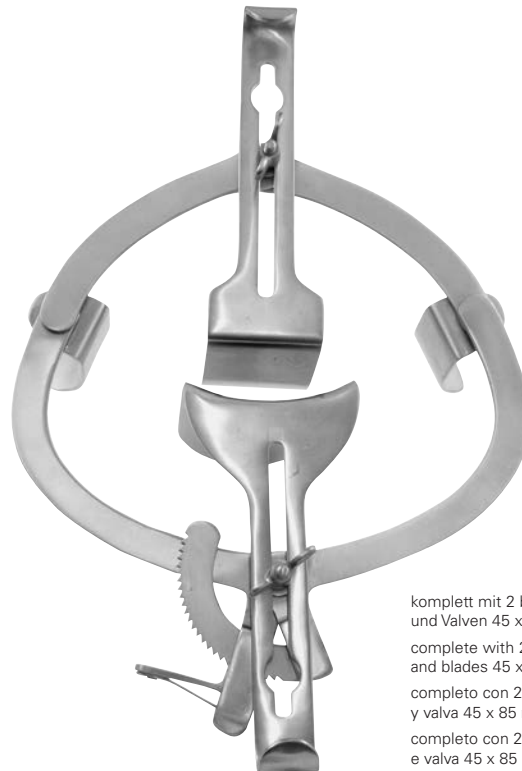

komplett mit 2 beweglichen Valven 25 x 60 mm
und Valven 45 x 85 mm | 70 x 105 mm
complete with 2 rotatable blades 25 x 60 mm
and blades 45 x 85 mm | 70 x 105 mm
completo con 2 valvas móviles 25 x 60 mm
y valva 45 x 85 mm | 70 x 105 mm
completo con 2 valve mobili 25 x 60 mm
e valva 45 x 85 mm | 70 x 105 mm

O'SULLIVAN - O'CONNOR

35-095-00



FRIEDMANN-JOLL

35-096-00	105,0 mm
35-097-00	155,0 mm



6,0 x 20,0 mm

35-097-24

KOGAN

35-097-24 24,0 cm, 9 ½"



6,0 x 20,0 mm

35-098-24

KOGAN

35-098-24 24,0 cm, 9 ½"



3,0 mm

35-099-24

6,0 mm

35-099-25

KOGAN

35-099-24 - 35-099-25 27,0 cm, 10¾"

HEGAR

35-106-14 4,0 - 17,0 mm

Satz 35-100-04 – 35-100-17 | 14 St.
 Set 35-100-04 – 35-100-17 | 14 pcs.
 Juego 35-100-04 – 35-100-17 | 14 piezas
 Set 35-100-04 – 35-100-17 | 14 pz.



HEGAR

35-100-01	Ø 1,0 mm
35-100-02	Ø 2,0 mm
35-100-03	Ø 3,0 mm
35-100-04	Ø 4,0 mm
35-100-05	Ø 5,0 mm
35-100-06	Ø 6,0 mm
35-100-07	Ø 7,0 mm
35-100-08	Ø 8,0 mm
35-100-09	Ø 9,0 mm
35-100-10	Ø 10,0 mm
35-100-11	Ø 11,0 mm
35-100-12	Ø 12,0 mm
35-100-13	Ø 13,0 mm
35-100-14	Ø 14,0 mm
35-100-15	Ø 15,0 mm

HEGAR

35-106-26 1,0 - 26,0 mm

Satz 35-100-01 – 35-100-26 | 26 St.
 Set 35-100-01 – 35-100-26 | 26 pcs.
 Juego 35-100-01 – 35-100-26 | 26 piezas
 Set 35-100-01 – 35-100-26 | 26 pz.

HEGAR

35-100-16	Ø 16,0 mm
35-100-17	Ø 17,0 mm
35-100-18	Ø 18,0 mm
35-100-19	Ø 19,0 mm
35-100-20	Ø 20,0 mm
35-100-21	Ø 21,0 mm
35-100-22	Ø 22,0 mm
35-100-23	Ø 23,0 mm
35-100-24	Ø 24,0 mm
35-100-25	Ø 25,0 mm
35-100-26	Ø 26,0 mm
35-100-27	Ø 27,0 mm
35-100-28	Ø 28,0 mm
35-100-29	Ø 29,0 mm
35-100-30	Ø 30,0 mm

HEGAR

35-105-01	Ø 1,5 mm
35-105-02	Ø 2,5 mm
35-105-03	Ø 3,5 mm
35-105-04	Ø 4,5 mm
35-105-05	Ø 5,5 mm
35-105-06	Ø 6,5 mm
35-105-07	Ø 7,5 mm
35-105-08	Ø 8,5 mm
35-105-09	Ø 9,5 mm
35-105-10	Ø 10,5 mm
35-105-11	Ø 11,5 mm
35-105-12	Ø 12,5 mm
35-105-13	Ø 13,5 mm
35-105-14	Ø 14,5 mm
35-105-15	Ø 15,5 mm
35-105-16	Ø 16,5 mm
35-105-17	Ø 17,5 mm
35-105-18	Ø 18,5 mm
35-105-19	Ø 19,5 mm

HEGAR

35-107-14 4,0 - 17,0 mm

Satz 35-100-04 – 35-100-17 | 14 St.
 Set 35-100-04 – 35-100-17 | 14 pcs.
 Juego 35-100-04 – 35-100-17 | 14 piezas
 Set 35-100-04 – 35-100-17 | 14 pz.

35-107-15 4,0 - 17,0 mm

Metalletui und Lagerungssieb, allein
 Metal case and rack, only
 Estuche de metal y soporte, suelta
 Scatola metallica e supporto, solo

35-107-16 4,0 - 17,0 mm

Metalletui 205 x 105 x 15 mm, allein
 Metal case 205 x 105 x 15 mm, only
 Estuche de metal 205 x 105 x 15 mm, suelta
 Scatola metallica 205 x 105 x 15 mm, solo

35-107-20 4,0 - 12,0 mm

35-107-21 13,0 - 17,0 mm

Lagerungssieb, allein
 Rack, only
 Soporte, suelta
 Supporto, solo

HEGAR

35-107-26 1,0 - 26,0 mm

Satz 35-100-01 – 35-100-26 | 26 St.
 Set 35-100-01 – 35-100-26 | 26 pcs.
 Juego 35-100-01 – 35-100-26 | 26 piezas
 Set 35-100-01 – 35-100-26 | 26 pz.

35-107-27 1,0 - 26,0 mm

Metalletui und Lagerungssieb, allein
 Metal case and rack, only
 Estuche de metal y soporte, suelta
 Scatola metallica e supporto, solo

35-107-17 1,0 - 26,0 mm

Metalletui 310 x 210 x 55 mm, allein
 Metal case 310 x 210 x 55 mm, only
 Estuche de metal 310 x 210 x 55 mm, suelta
 Scatola metallica 310 x 210 x 55 mm, solo

35-107-22 1,0 - 17,0 mm

35-107-23 18,0 - 26,0 mm

Lagerungssieb, allein
 Rack, only
 Soporte, suelta
 Supporto, solo



HEGAR

35-111-01 3/4 - 17/18 mm

Satz 35-110-04 – 35-110-18 | 8 St.
Set 35-110-04 – 35-110-18 | 8 pcs.
Juego 35-110-04 – 35-110-18 | 8 piezas
Set 35-110-04 – 35-110-18 | 8 pz.



HEGAR

35-111-02 1/2 - 25/26 mm

Satz 35-110-02 – 35-110-26 | 13 St.
Set 35-110-02 – 35-110-26 | 13 pcs.
Juego 35-110-02 – 35-110-26 | 13 piezas
Set 35-110-02 – 35-110-26 | 13 pz.

HEGAR

35-110-02	Ø 1 - 2 mm
35-110-04	Ø 3 - 4 mm
35-110-06	Ø 5 - 6 mm
35-110-08	Ø 7 - 8 mm
35-110-10	Ø 9 - 10 mm
35-110-12	Ø 11 - 12 mm
35-110-14	Ø 13 - 14 mm
35-110-16	Ø 15 - 16 mm
35-110-18	Ø 17 - 18 mm
35-110-20	Ø 19 - 20 mm
35-110-22	Ø 21 - 22 mm
35-110-24	Ø 23 - 24 mm
35-110-26	Ø 25 - 26 mm



HEGAR

35-111-03 3/4 - 17/18 mm

Satz 35-110-04 – 35-110-18 | 8 St.
Set 35-110-04 – 35-110-18 | 8 pcs.
Juego 35-110-04 – 35-110-18 | 8 piezas
Set 35-110-04 – 35-110-18 | 8 pz.



HEGAR

35-111-08 1/2 - 25/26 mm

Satz 35-110-02 – 35-110-26 | 13 St.
Set 35-110-02 – 35-110-26 | 13 pcs.
Juego 35-110-02 – 35-110-26 | 13 piezas
Set 35-110-02 – 35-110-26 | 13 pz.



35-120-32

starr
rigid
rigida
rigido



35-121-32

biegsam
malleable
maleabile
malleabile



SIMS

35-120-32 - 35-121-32 32,0 cm, 12 1/2"



35-122-32

starr
rigid
rigida
rigido



35-123-32

biegsam
malleable
maleabile
malleabile



MARTIN

35-122-32 - 35-123-32 32,0 cm, 12 1/2"



VALLEIX

35-125-25 29,5 cm, 11 1/2"



Uterus-Depressor
Uterine Depressor
Depresores uterinos
Depressori uterini

BRAUN

35-200-26 28,0 cm, 11 "



Uterus-Depressor
Uterine Depressor
Depresores uterinos
Depressori uterini

SIMS

35-201-26 26,0 cm, 10 ¼ "



stumpf
blunt
romas
smusse



35-202-27

13,0 mm

8,0 mm

scharf
sharp
cortantes
acute

Uteruskürette
Uterine curette
Curete uterina
Curette uterine

BLAKE

35-202-27 28,0 cm, 11 "



35-204-25

SCHROEDER

35-204-25 25,0 cm, 9 3/4"



35-206-25

BRAUN

35-206-25 25,0 cm, 9 3/4"



35-208-17

STAUDE-MOORE

35-208-17 17,0 cm, 6 3/4"



35-209-28

DUPLAY

35-209-28 28,0 cm, 11 "



35-210-18

POZZI

35-210-18 18,0 cm, 7 "



35-210-26

POZZI

35-210-26 25,5 cm, 10 "



35-211-24

SKENE

35-211-24 24,0 cm, 9 1/2"



Amniotom
 Amniotome
 Amniótomo
 Amniotomo

BEACHAM

35-212-26 26,0 cm, 10 1/4"

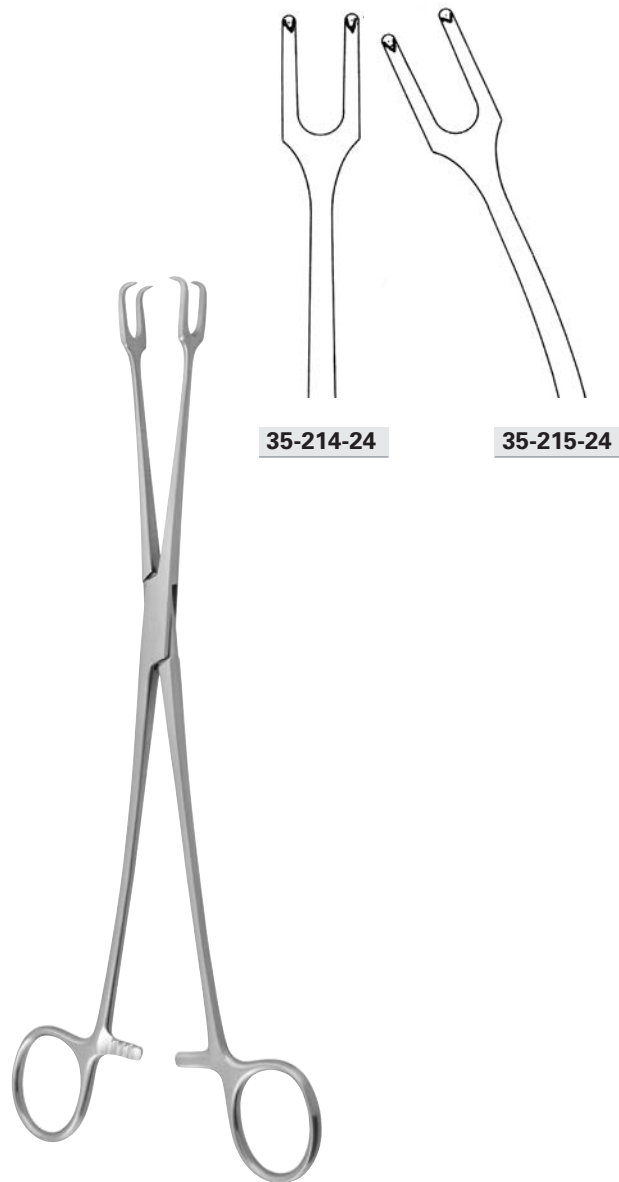

35-214-24

35-215-24

SCHROEDER

35-214-24 - 35-215-24 24,0 cm, 9 1/2"

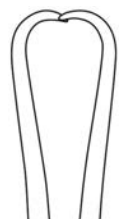

35-216-24

WILSON

35-216-24 24,0 cm, 9 1/2 "



35-217-18
35-217-23

3 x 4 Zähne
3 x 4 teeth
3 x 4 dientes
3 x 4 denti

TEALE

35-217-18 18,0 cm, 7 "
35-217-23 23,0 cm, 9 "



35-218-25

2 x 3 Zähne
2 x 3 teeth
2 x 3 dientes
2 x 3 denti

KUESTNER

35-218-25 25,0 cm, 9 3/4 "

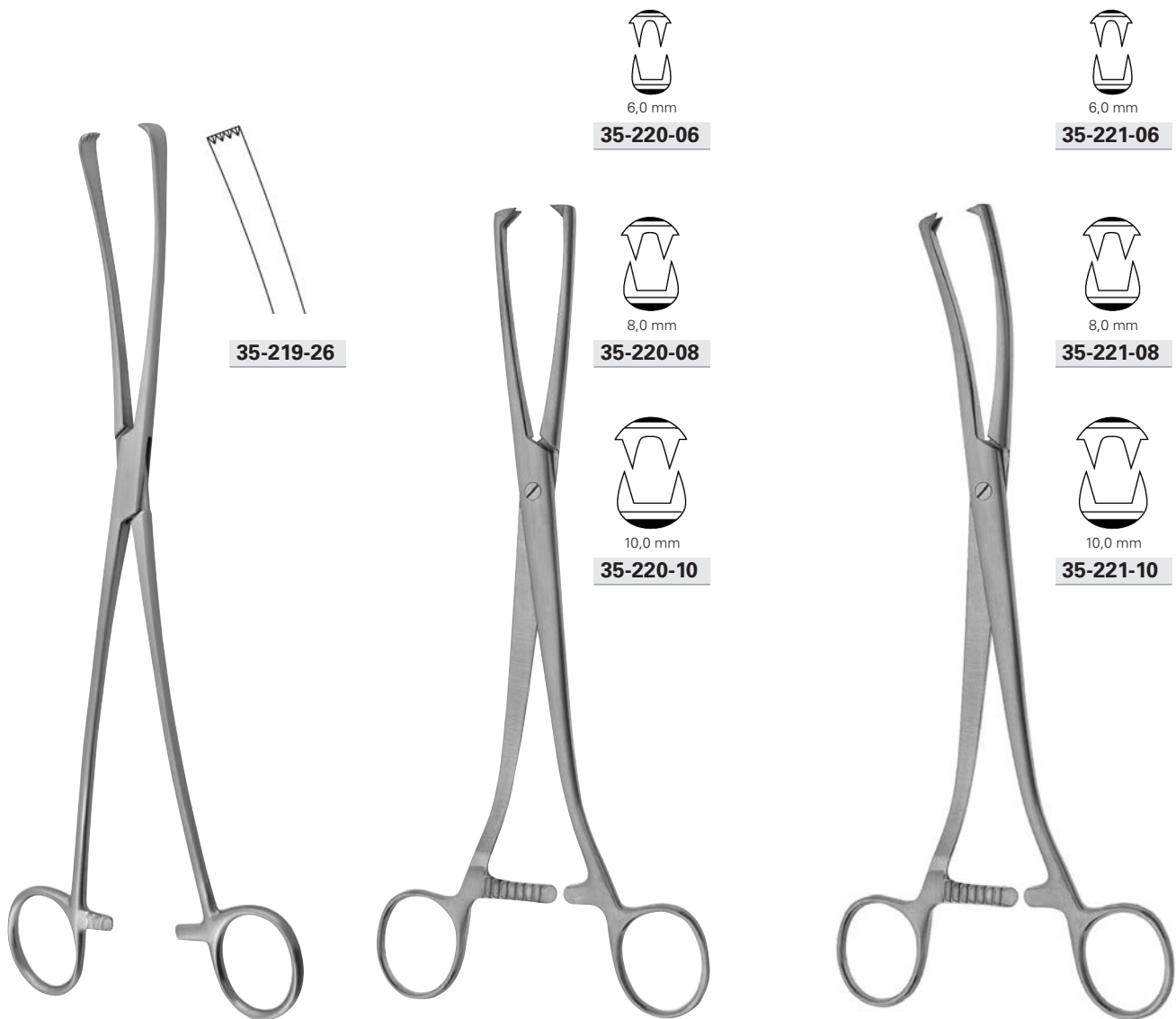

IOWA

35-219-26 26,0 cm, 10 ¼"

MUSEUX

35-220-06 - 35-220-10 24,0 cm, 9 ½"

MUSEUX

35-221-06 - 35-221-10 24,0 cm, 9 ½"



35-222-20

MUSEUX

35-222-20 20,0 cm, 8"



35-222-21

JACOBS

35-222-21 21,0 cm, 8 ¼"



35-223-21

JACOBS

35-223-21 21,0 cm, 8 ¼"

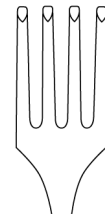

35-226-21

CZERNY

35-226-21 20,5 cm, 8"



PRATT

35-224-28 26,0 cm, 10 1/4"

PRATT

35-225-27 27,0 cm, 10 3/4"

SCHROEDER

35-226-27 27,0 cm, 10 3/4"



35-228-01



LAHEY

35-228-01 15,0 cm, 6 "



35-228-03



BRAUN

35-228-03 15,5 cm, 6 1/8 "

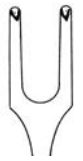

35-228-04



MUSEUX

35-228-04 20,0 cm, 8 "

Ø 25,0 mm
35-233-17



DOYEN

35-233-17 16,5 cm, 6 1/2 "

Ø 20,0 mm
35-234-17



DOYEN

35-234-17 17,0 cm, 6 3/4 "



DARTIGUES

35-230-27 27,0 cm, 10³/₄"



SOMER

35-231-23 23,0 cm, 9"



COLLIN

35-232-25 25,0 cm, 9 3/4"



COLLIN

35-236-25 25,0 cm, 9 3/4"

Instrument für die Entfernung von Spiralen
 Instrument for removal of I.U.D
 Instrumento para remoer dispositivo tintrauterino
 Strumento per la rimozione dell I.U.D.



35-302-20

Sekretlöffel
 Secretion scoop
 Curette secreción
 Cucchiaio secreto



35-302-27

Sekretlöffel
 Secretion scoop
 Curette secreción
 Cucchiaio secreto



35-302-42

Uteruslöffel
 Uterine scoop
 Curette uterine
 Cucchiaio uterine



35-304-32

SAUNDERS

35-304-32 32,0 cm, 16 1/2"

ASCH

35-302-20 20,0 cm, 8"

35-302-27 27,0 cm, 10 3/4"

WALLICH

35-302-42 42,0 cm, 10 1/2"

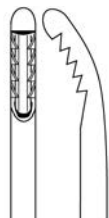

35-301-01	Ø 1,0 mm
35-301-02	Ø 2,0 mm
35-301-03	Ø 3,0 mm
35-301-04	Ø 4,0 mm

NOVAK

35-301-01 - 35-301-04 23,0 cm, 9"



35-303-04
Ø 4,0 mm

RANDALL

35-303-04 25,0 cm, 9 3/4"



3,0 mm
35-305-04



3,0 mm
35-306-04

KEVORKIAN

35-305-04 - 35-306-04 30,0 cm, 11 3/4"

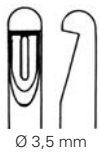

Ø 3,5 mm

35-307-03

MOD. BERLIN

35-307-03 27,0 cm, 10³/₄"

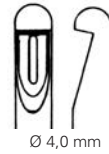

Ø 4,0 mm

35-307-04

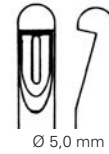

Ø 5,0 mm

35-307-05

MOD. MUENCHEN

35-307-04 - 35-307-05 27,0 cm, 10³/₄"



35-308-05	Ø 5,0 mm
35-308-07	Ø 7,0 mm
35-308-09	Ø 9,0 mm

Biopsieküretten, biegsam
Biopsy curettes, malleable
Curetas para biopsia, maleable
Curette per biopsia, malleabile

35-308-15	Ø 5,0 mm
35-308-17	Ø 7,0 mm
35-308-19	Ø 9,0 mm

Biopsieküretten, starr
Biopsy curettes, rigid
Curetas para biopsia, rigida
Curette per biopsia, rigido



35-309-03	Ø 3,0 mm
35-309-04	Ø 4,5 mm
35-309-06	Ø 6,0 mm
35-309-08	Ø 8,0 mm
35-309-10	Ø 10,0 mm
35-309-12	Ø 12,0 mm
35-309-14	Ø 14,0 mm



35-309-50

Kupplungsstück
Connecting piece
Pieza de acoplamiento
Pezzo di collegamento

MILAN

35-308-05 - 35-308-19 28,5 cm, 11 ¼"

35-309-03 - 35-309-14 28,5 cm, 11 ¼"



35-310-01

Adapter, klein
 Adaptor, small
 Adattatore, pequeño
 Adattatore, piccolo

35-310-02

Adapter, groß
 Adaptor, large
 Adattatore, grande
 Adattatore, grande

Uterus Känule komplett, mit Adapter
 35-310-01 und 35-310-02
 Uterine cannula complete, with adaptor
 35-310-01 and 35-310-02
 Cànula para uterine completo, con
 adattatore 35-310-01 y 35-310-02
 Cannule per uterine completo, con
 adattatore 35-310-01 e 35-310-02

COEN

35-310-00 SET



35-330-99

Tubenkatheter
 Uterine cannula
 Sonda para trompas
 Cannula uterina

Komplett, im Holzetui
 Complete, in wooden case
 Completo, en estuche de madera
 Completo, in scatola di legno

SCHULTZE

35-320-00 SET



35-340-03

Verschlusskegel
 Occlusive nozzle
 Cono oclusión
 Cono d'occlusione



35-340-04

Verschlusskegel
 Occlusive nozzle
 Cono oclusión
 Cono d'occlusione



35-340-05

Verschlusskegel
 Occlusive nozzle
 Cono oclusión
 Cono d'occlusione



35-340-00

Manometer
 Manometer
 Manómetro
 Manometro



35-340-20

Spritze, 10 ml
 Syringe, 10 ml
 Jeringa, 10 ml
 Siringa, 10 ml



35-340-01

Verbindungsstück
 Connecting piece
 Pieza conectiva
 Connessione

Komplett, ohne Manometer
 Complete, without manometer
 Completo, sin manómetro
 Completo, senza manometro

SCHULTZE

35-330-00 SET



35-401-21
35-401-24

FAURE

35-401-21	21,0 cm, 8 ¼"
35-401-24	24,0 cm, 9 ½"

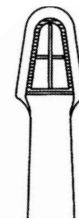

4,8 mm

35-402-21
35-402-29

SCHUBERT

35-402-21	21,0 cm, 8 ¼"
35-402-29	29,0 cm, 11 ¼"



SCHUBERT

35-403-26 26,0 cm, 10 1/4"



TISCHLER

35-404-27 27,0 cm, 10 3/4"



SCHUMACHER-VAN DOREN

35-405-24 - 35-405-25 24,0 cm, 9 1/2"

VAN DOREN

35-406-25 25,0 cm, 9 3/4"

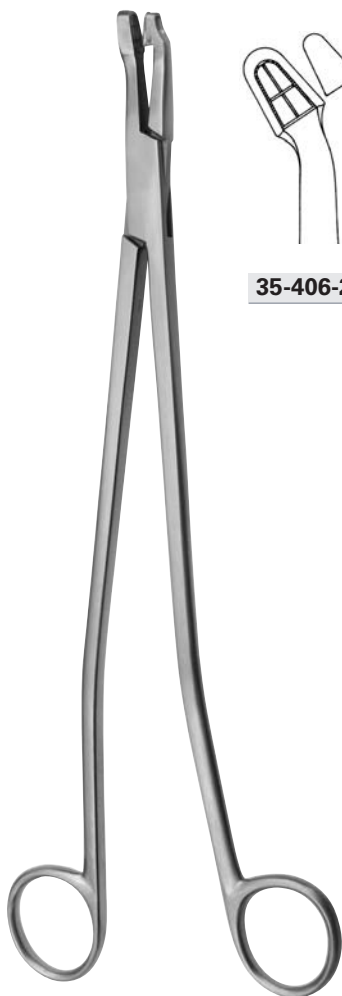

35-406-26

VAN DOREN

35-406-26 25,0 cm, 9 3/4 "



35-407-24

THOMS-GAYLOR

35-407-24 24,0 cm, 9 1/2 "



35-409-23

GELLHORN

35-409-23 23,0 cm, 9 "

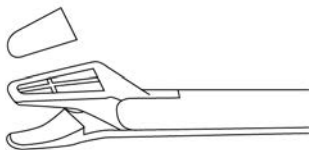
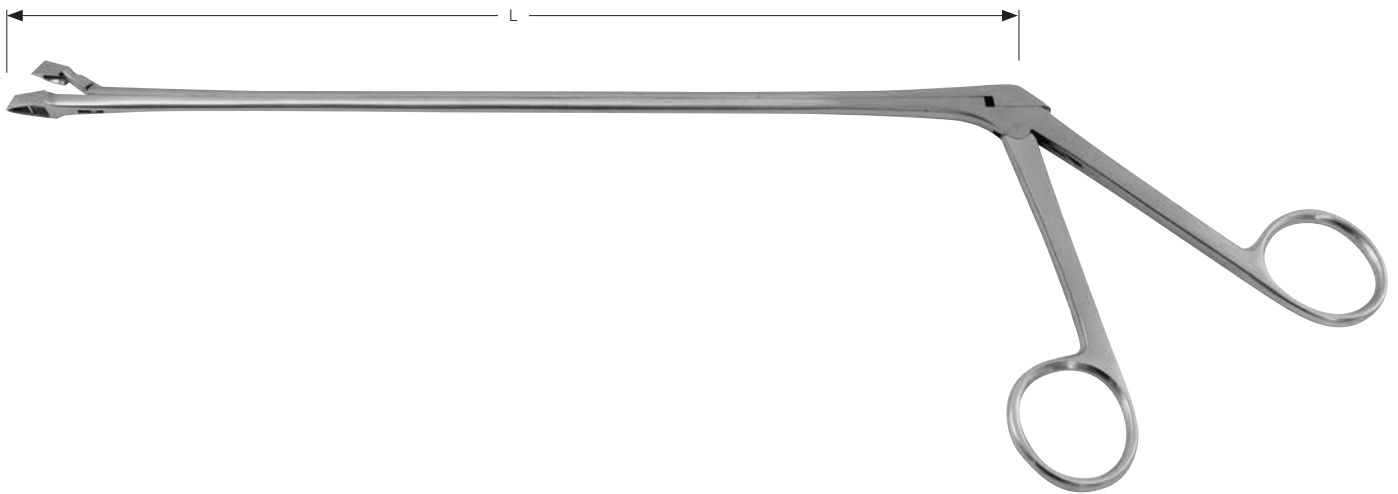

ALEXANDER

35-410-28 20,0 cm, 8 "

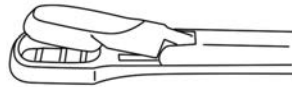

DOUAY

35-411-20 20,0 cm, 8 "
35-411-25 25,0 cm, 9 3/4 "
35-411-30 30,0 cm, 11 3/4 "
35-411-35 35,0 cm, 13 3/4 "
35-411-40 40,0 cm, 16 "

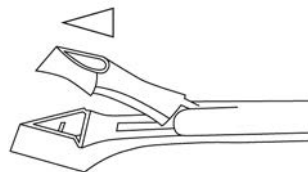

SCHUMACHER

35-412-01 24,0 cm, 9 1/4 "

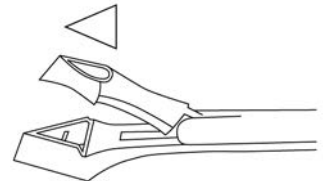

SCHUMACHER

35-412-02 24,0 cm, 9 1/4 "

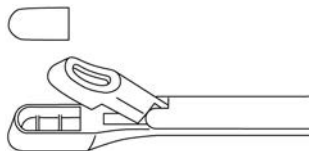

EPPENDORF

35-414-20 20,0 cm, 8 "
35-414-23 23,0 cm, 9 "

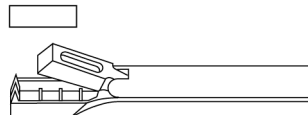

KEVORKIAN

35-416-20 20,0 cm, 8 "
35-416-23 23,0 cm, 9 "
35-416-24 25,0 cm, 9 3/4 "

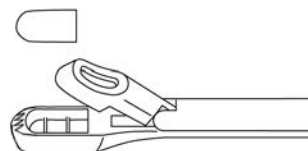

WITTNER

35-420-23 23,0 cm, 9 "

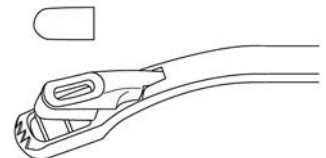

WITTNER

35-421-23 23,0 cm, 9 "

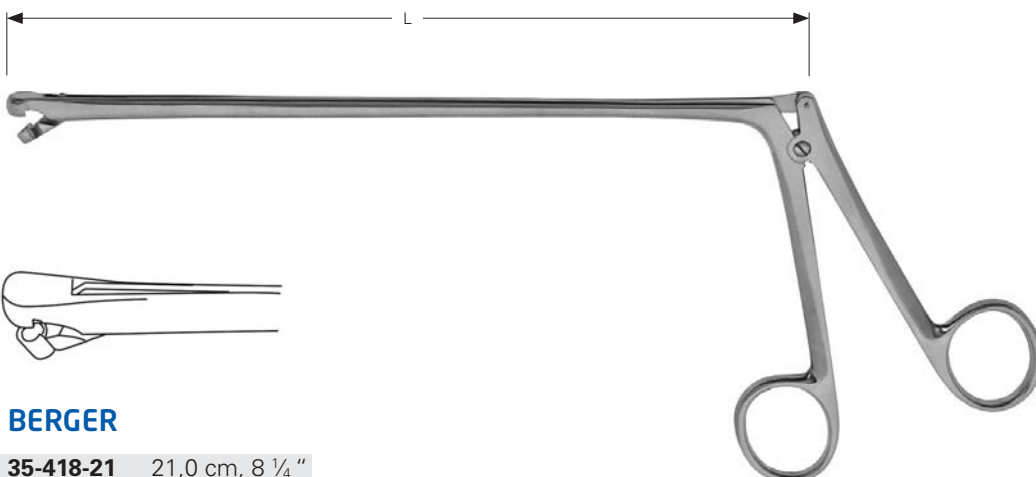

BERGER

35-418-21 21,0 cm, 8 1/4 "

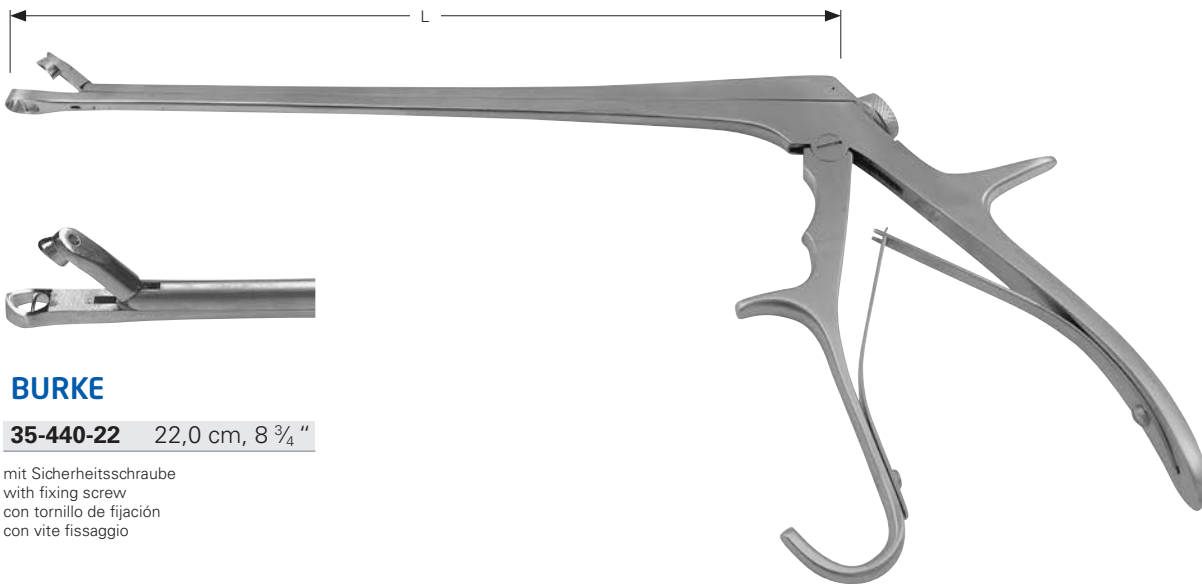

BURKE

35-440-22 22,0 cm, 8 3/4 "

mit Sicherheitsschraube
 with fixing screw
 con tornillo de fijación
 con vite fissaggio

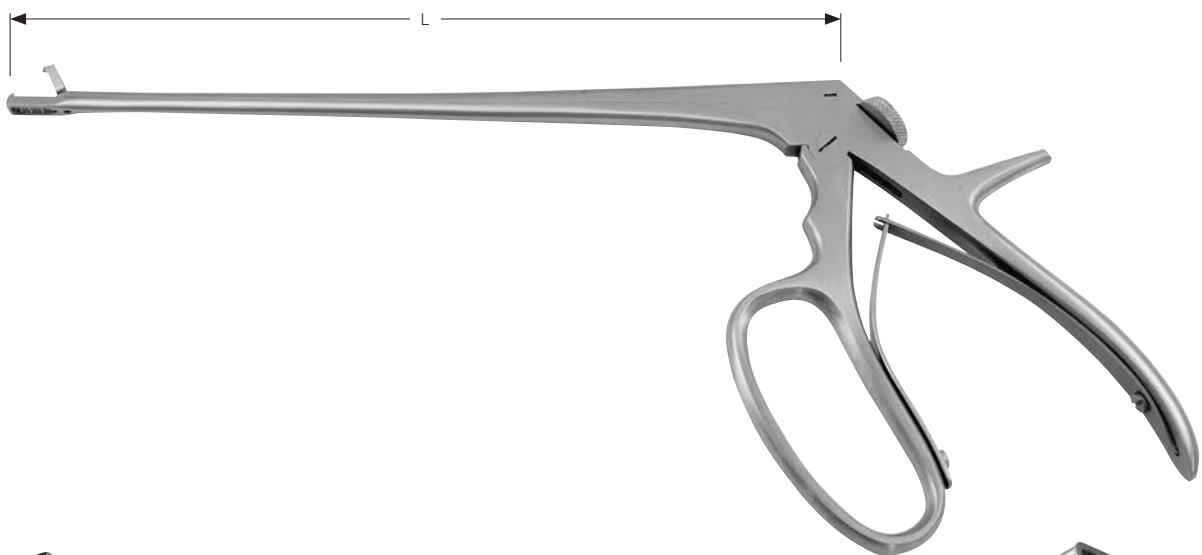

TISCHLER-KEVORKIAN

35-442-22 22,0 cm, 8 3/4 "

mit Sicherheitsschraube
 with fixing screw
 con tornillo de fijación
 con vite fissaggio

KEVORKIAN-PACIFIC

35-444-22 22,0 cm, 8 3/4 "

mit Sicherheitsschraube
 with fixing screw
 con tornillo de fijación
 con vite fissaggio

TISCHLER

35-446-22 23,0 cm, 9 "

mit Sicherheitsschraube
 with fixing screw
 con tornillo de fijación
 con vite fissaggio



BABY-TISCHLER

35-448-20 20,0 cm, 8 "

mit Sicherheitsschraube
 with fixing screw
 con tornillo de fijación
 con vite fissaggio



BABY-TISCHLER

35-448-21 20,0 cm, 8 "

ohne Sicherheitsschraube
 without fixing screw
 sin tornillo de fijación
 senza vite fissaggio



TISCHLER-MORGAN

35-450-22 22,0 cm, 8 3/4 "

ohne Sicherheitsschraube
 without fixing screw
 sin tornillo de fijación
 senza vite fissaggio

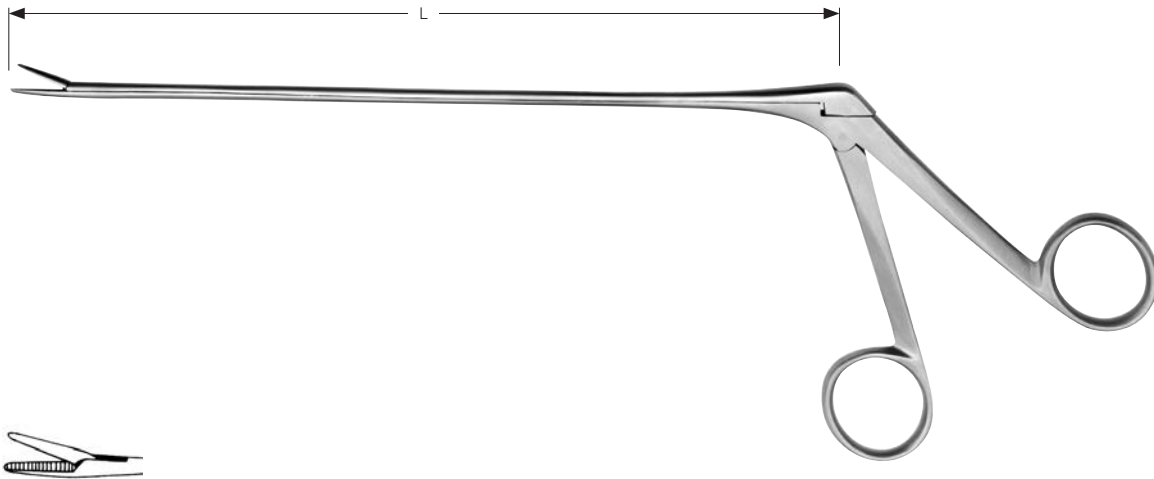

35-455-20 20,0 cm, 8"

Instrument für die Entfernung von Spiralen
Instrument for removal of I.U.D.
Instrumento para remoer dispositivo tintrauterino
Strumento per la rimozione dell I.U.D.

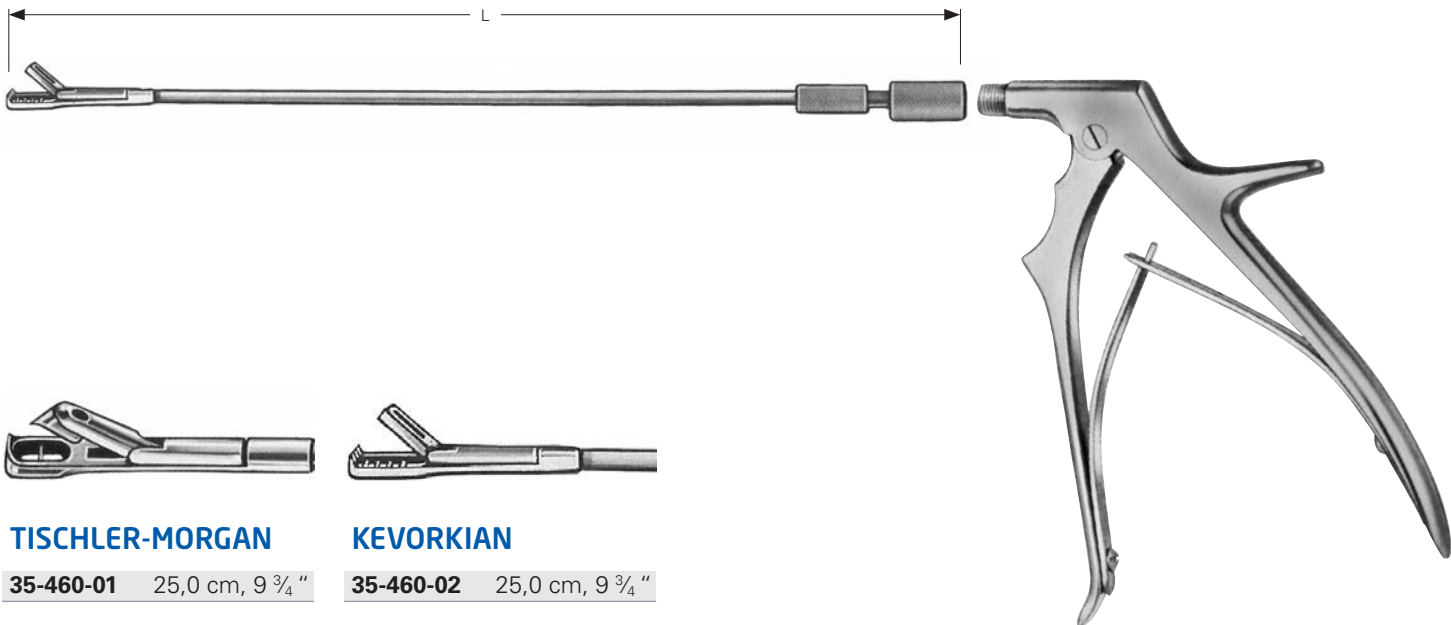

TISCHLER-MORGAN

35-460-01 25,0 cm, 9 3/4"

KEVORKIAN

35-460-02 25,0 cm, 9 3/4"

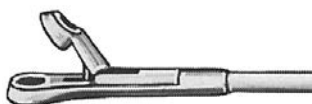

EPPENDORF

35-460-03 25,0 cm, 9 3/4"



MINI-TOWNSEND

35-460-05 25,0 cm, 9 3/4"

35-460-00

Griff
Handle
Mango
Manico



35-470-00

Universalgriff
Universal Handle
Mango universal
Manico universale

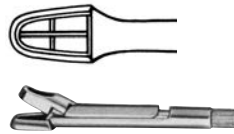

EPPENDORF

35-470-02

Aufsatz
Tip
Punta
Punta



35-470-01 20,0 cm, 8 "

Verlängerungsrohr
Elongation tube
Tubo de extensión
Tubi di prolungamento



35-470-03 SET

Komplett, 35-470-00, 35-470-01, 35-470-03
Complete, 35-470-00, 35-470-01, 35-470-03
Completo, 35-470-00, 35-470-01, 35-470-03
Completo, 35-470-00, 35-470-01, 35-470-03

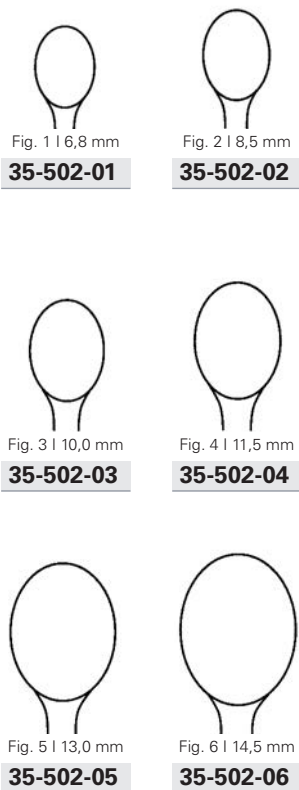

scharf, fest
sharp, rigid
cortantes, rígidas
acute, rigide

SCHROEDER

35-502-01 - 35-502-06 30,0 cm, 11 3/4"

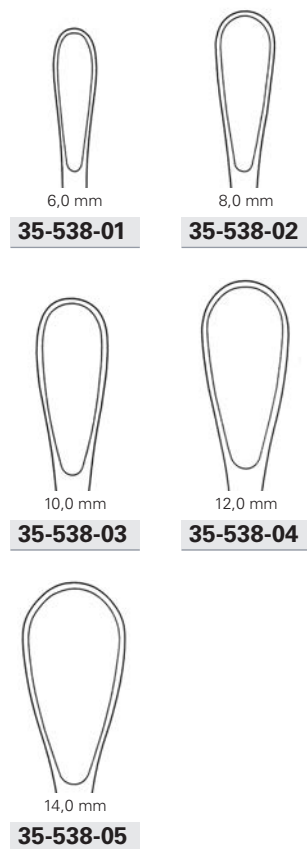

stumpf, fest
blunt, rigid
romas, rígidas
smusse, rigide

GOURDET

35-538-01 - 35-538-05 28,0 cm, 11"

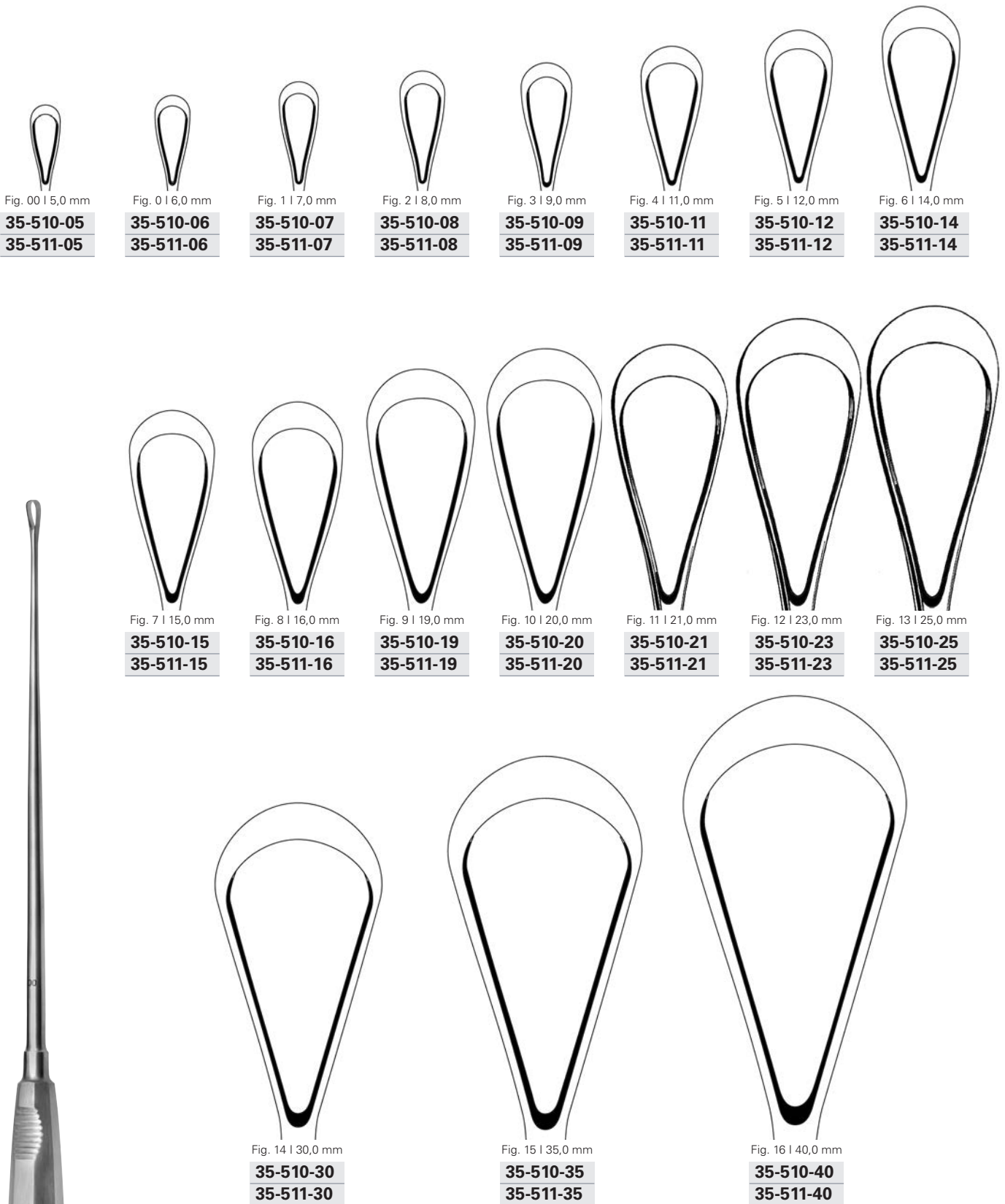

RECAMIER

35-510-05 - 35-510-40 31,0 cm, 12 1/4"

scharf, fest
 sharp, rigid
 cortantes, rígidas
 acute, rigide

RECAMIER

35-511-05 - 35-511-40 31,0 cm, 12 1/4"

scharf, biegsam
 sharp, malleable
 cortantes, maleables
 acute, malleabile

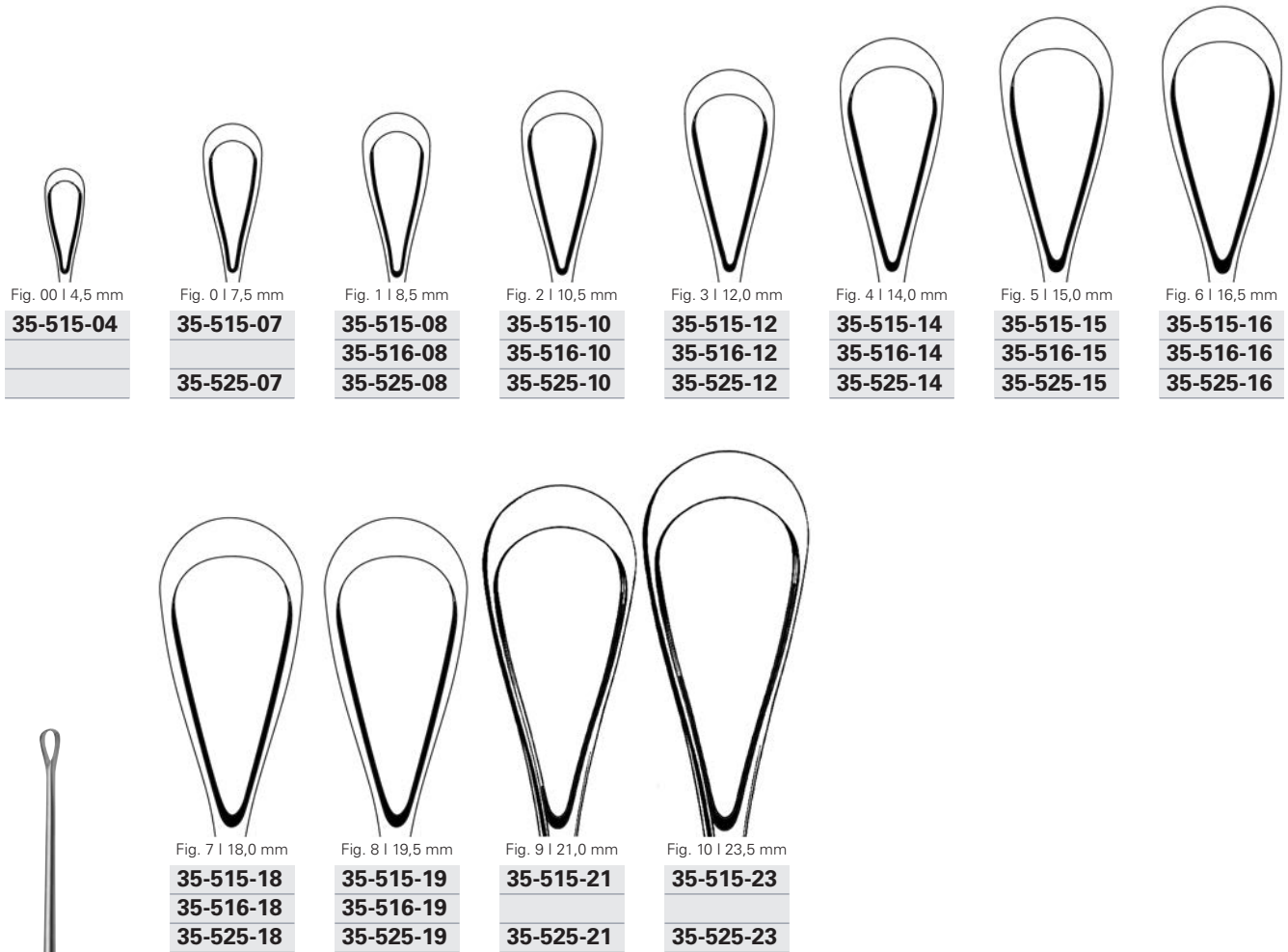

RECAMIER

35-515-04 - 35-515-23 30,0 cm, 11 3/4"

scharf, fest
sharp, rigid
cortantes, rígidas
acute, rigide

RECAMIER

35-516-08 - 35-516-19 30,0 cm, 11 3/4"

scharf, biegsam
sharp, malleable
cortantes, maleabeles
acute, malleabile

RECAMIER

35-525-07 - 35-525-23 30,0 cm, 11 3/4"

stumpf, fest
blunt, rigid
romas, rígidas
smusse, rigide

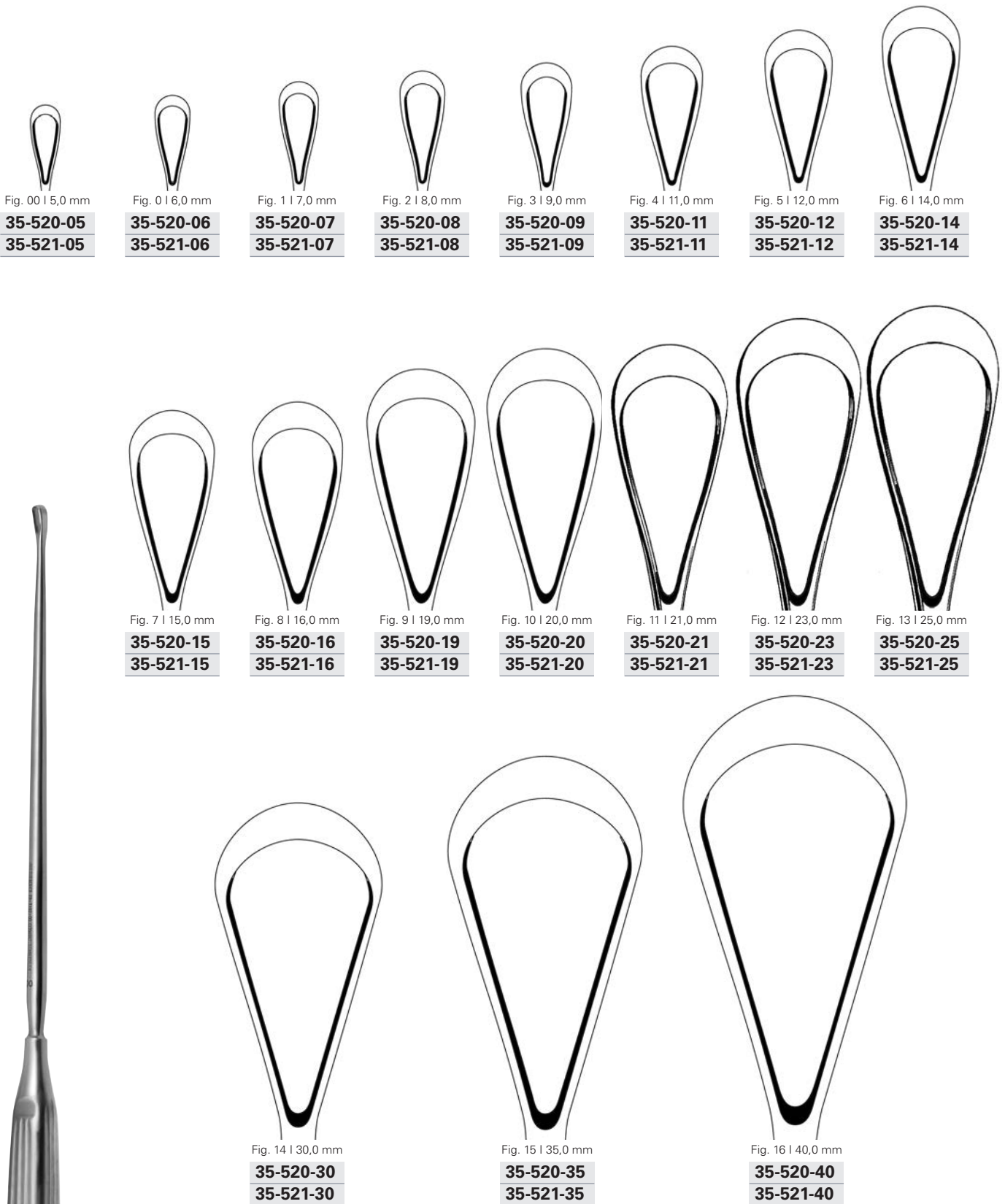

SIMS

35-520-05 - 35-520-40 31,0 cm, 12 1/4"

stumpf, fest
 blunt, rigid
 romas, rígidas
 smusse, rigide

SIMS

35-521-05 - 35-521-40 31,0 cm, 12 1/4"

stumpf, biegsam
 blunt, malleable
 romas, maleabeles
 smusse, malleabile

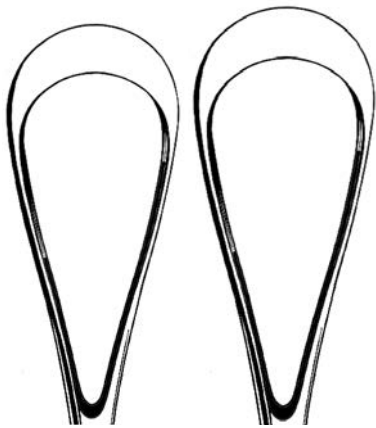

Fig. 1 | 23,5 mm

35-516-23
35-526-23

Fig. 2 | 26,0 mm

35-516-26
35-526-26



Fig. 3 | 28,5 mm

35-516-28
35-526-28

BUMM

35-516-23 - 35-516-28 31,0 cm, 12 1/4"

scharf, biegsam
sharp, malleable
cortantes, maleabeles
acute, malleabile

BUMM

35-526-23 - 35-526-28 31,0 cm, 12 1/4"

stumpf, biegsam
blunt, malleable
romas, maleabeles
smusse, malleabile

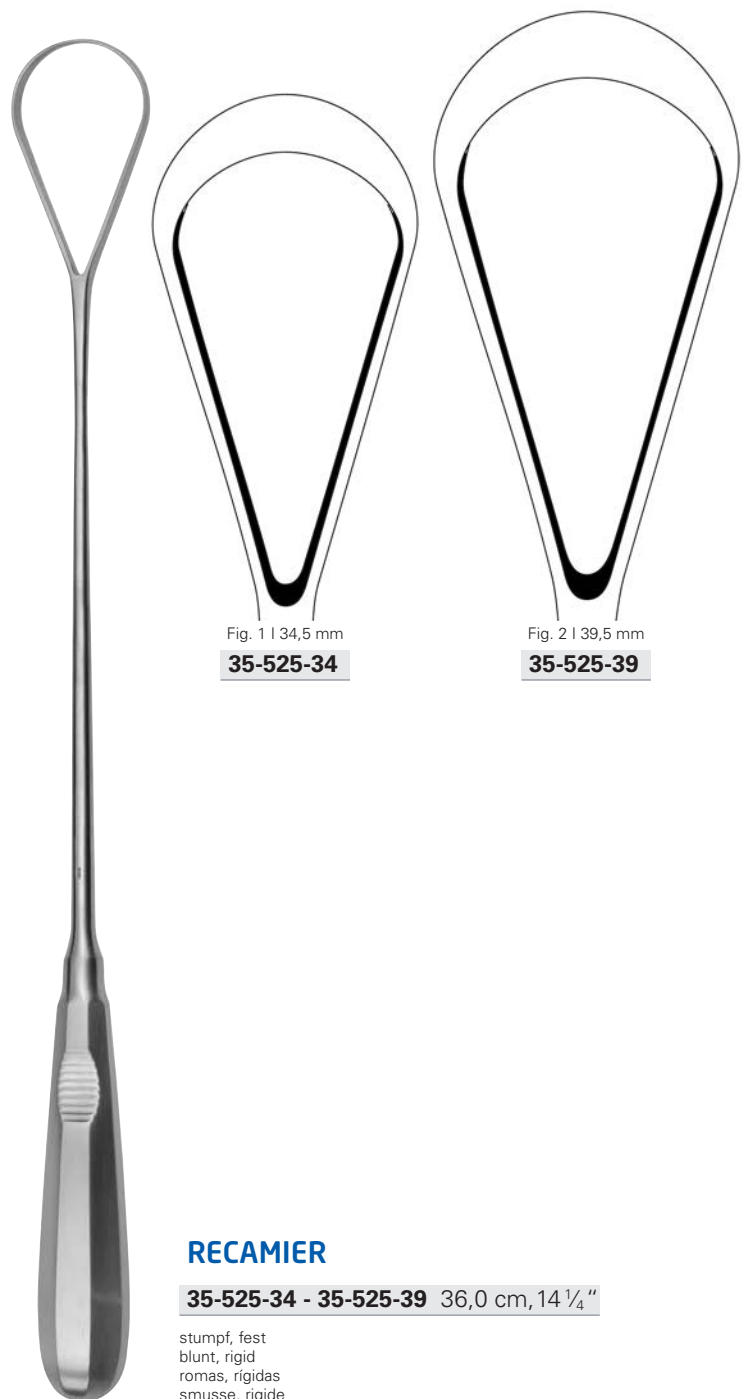

Fig. 1 | 34,5 mm

35-525-34

Fig. 2 | 39,5 mm

35-525-39

RECAMIER

35-525-34 - 35-525-39 36,0 cm, 14 1/4"

stumpf, fest
blunt, rigid
romas, rígidas
smusse, rigide

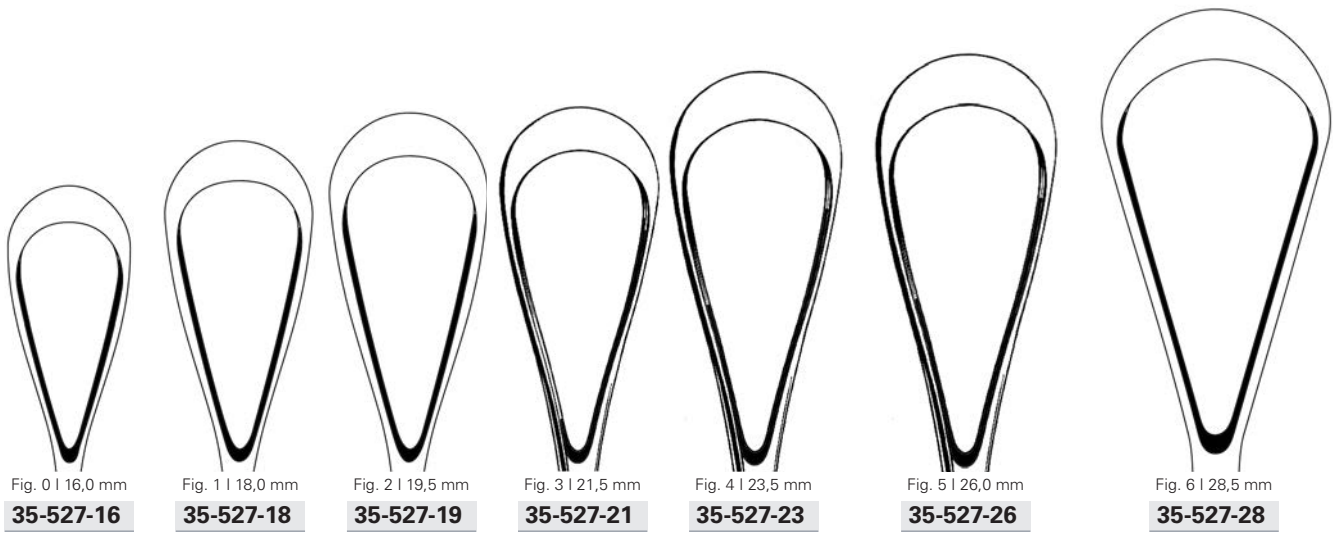

BUMM

35-527-16 - 35-527-28 29,0 cm, 11 1/4"

stumpf, biegsam
blunt, malleable
romas, maleabeles
smusse, malleabile



Fig. 1 | 7,5 mm

35-530-01
35-531-01
35-532-01



Fig. 2 | 8,5 mm

35-530-02
35-531-02
35-532-02



Fig. 3 | 10,5 mm

35-530-03
35-531-03
35-532-03



Fig. 4 | 12,0 mm

35-530-04
35-531-04
35-532-04



Fig. 5 | 14,0 mm

35-530-05
35-531-05
35-532-05



Fig. 6 | 15,0 mm

35-530-06
35-531-06
35-532-06



SIMS

35-530-01 - 35-530-06 26,0 cm, 10 1/4"

scharf, fest
sharp, rigid
cortantes, rígidas
acute, rigide

SIMS

35-531-01 - 35-531-06 26,0 cm, 10 1/4"

scharf, biegsam
sharp, malleable
cortantes, maleabeles
acute, malleabile

SIMS

35-532-01 - 35-532-06 26,0 cm, 10 1/4"

stumpf, fest
blunt, rigid
romas, rígidas
smusse, rigide

graduiert in cm und Zoll
graduated in cm and inches
graduato en cm y pulgadas
graduato in cm e pollici



MARTIN

35-701-34 34,0 cm, 13 1/3"

graduiert in cm
graduated in cm
graduato en cm
graduato in cm

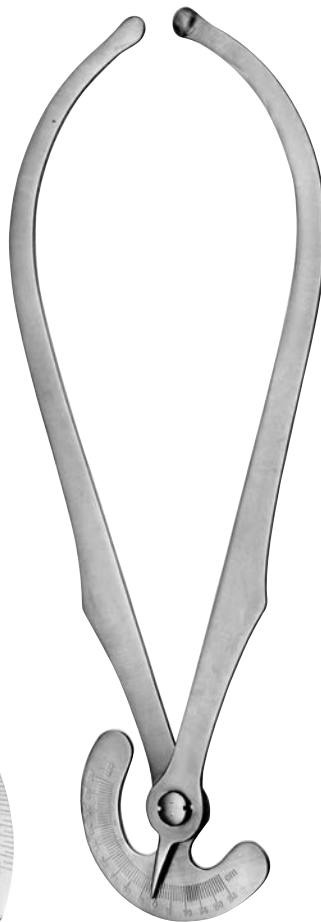

COLLIN

35-703-35 35,0 cm, 13 3/4"

graduiert in cm und Zoll
graduated in cm and inches
graduato en cm y pulgadas
graduato in cm e pollici

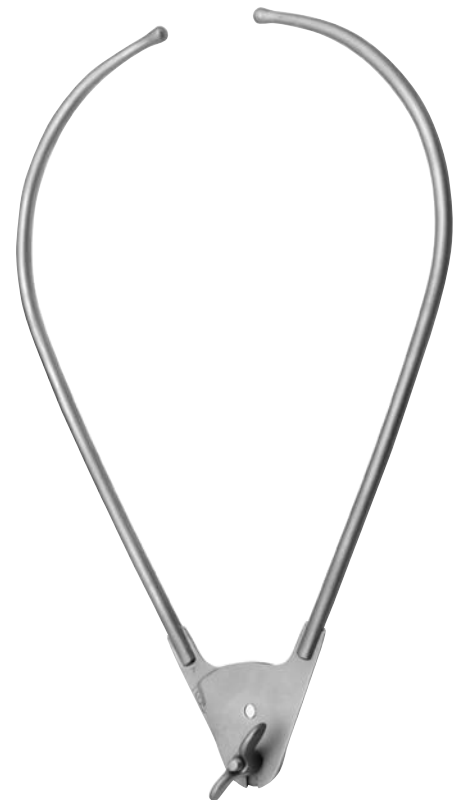

COLLYER

35-705-30 30,0 cm, 11 3/4"



DE LEE

35-710-30	30,0 cm, 11 3/4"
35-710-36	36,0 cm, 14 1/4"
35-710-39	39,0 cm, 15 1/2"



NAEGELE

35-711-36	36,0 cm, 14 1/4"
35-711-40	40,0 cm, 16"



SIMPSON

35-713-23	23,0 cm, 9"
------------------	-------------



SIMPSON

35-713-30 30,0 cm, 11 3/4"



SIMPSON

35-713-36 36,0 cm, 14 1/4"



KIELLAND

35-715-41 41,0 cm, 16"



SIMPSON-LUIKART

35-716-36 36,0 cm, 14 1/4"



PIPER

35-717-44 44,0 cm, 17 1/2"



BOERMA

35-719-29 29,0 cm, 11 1/2"



WRIGLEY

35-721-25	25,0 cm, 9 3/4 "
35-721-29	28,0 cm, 11 "



Geburtszange mit Achsenzugvorrichtung
Forceps with traction rod
Fórceps con dispositivo de tracción
Forcipi con dispositivo di trazione

TARNIER

35-723-40	40,0 cm, 16 "
------------------	---------------



Zughebel, passend für alle Geburtszangen mit gehorntem Standard-Griff.
Traction handle suitable for all forceps with standard type handle.
Tractor adecuado para todas las fórceps con mango standard.
Manico a trazione adatto a tutte le forcipi con manico standard.

BILL

35-724-01

Zangenschloß
Traction handle
Cierre de la pinza
Fermapinza



LUIKART-BILL

35-724-02



Geburtslöffel
Obstetric lever
Seperador obstétrica
Leva ostetrica

SELLHEIM

35-731-28 28,0 cm, 11"



35-732-21

Uterusklemmzange zur Blutstillung
Caesarean section haemostatic forceps
Pinza-clamp uterina para hemostasis
Pinza emostatiche per tagli cesarei

GREEN-ARMYTAGE

35-732-21 21,0 cm, 8 1/4"

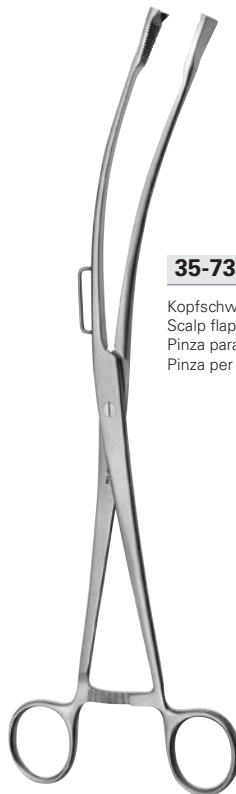

35-733-27

Kopfschwartenzange
Scalp flap forceps
Pinza para pericráneo
Pinza per il cuoio cappelluto

GAUSS

35-733-27 27,0 cm, 10 3/4"



35-734-19

Kopfschwartenzange
Scalp flap forceps
Pinza para pericráneo
Pinza per il cuoio cappelluto

WILLET

35-734-19 19,0 cm, 7 1/2"

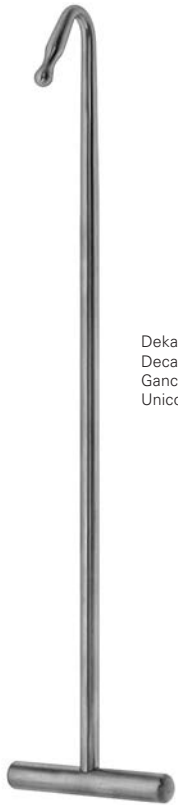

Dekapitationshaken
 Decapitating Hooks
 Ganchos para decapitación
 Unico per detroncazione

BRAUN

35-735-30 30,0 cm, 11 3/4"



Dekapitationshaken
 Decapitating Hooks
 Ganchos para decapitación
 Unico per detroncazione

SMELLIE

35-736-30 30,0 cm, 11 3/4"

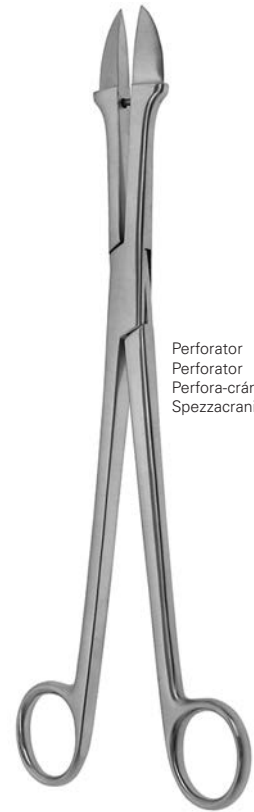

Perforator
 Perforator
 Perfora-cráneos
 Spezzacrani

SMELLIE

35-736-25 25,0 cm, 9 3/4"



Nabelschnurklemme
 Umbilical cord clamp
 Clamp umbilical
 Clamp ombelicale

COLLIN

35-737-09 9,0 cm, 3 1/2"



Nabelschnurklemme
 Umbilical cord clamp
 Clamp umbilical
 Clamp ombelicale

KANE

35-739-09 8,5 cm, 3 1/3"



BRAUN

35-738-42 42,0 cm, 16 1/2"

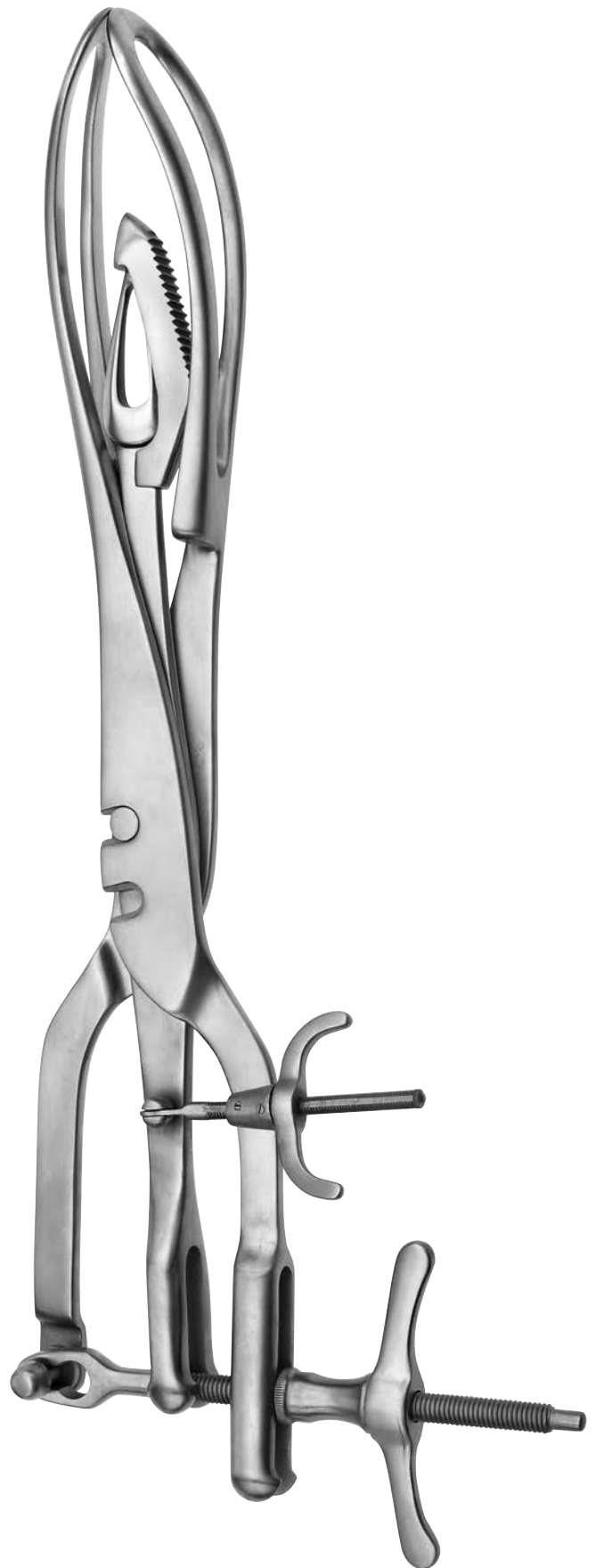

TARNIER

35-738-46 44,0 cm, 18"

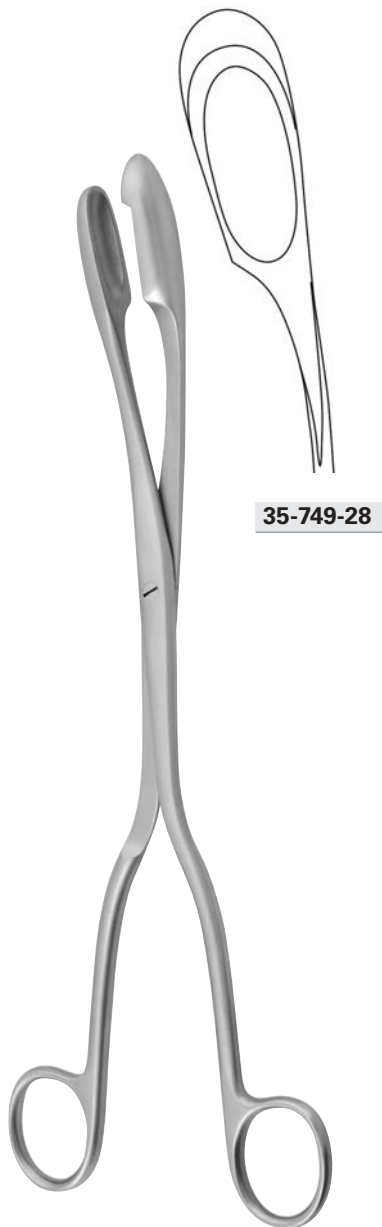

35-749-28

WINTER

35-749-28 28,5 cm, 11 1/4"



Fig. 1
35-750-01

Fig. 2
35-750-02

Fig. 3
35-750-03

Fig. 1
35-751-01

Fig. 2
35-751-02

Fig. 3
35-751-03

WINTER

35-750-01 - 35-751-03 28,0 cm, 11"



WINTER

35-751-12 - 35-751-13 29,0 cm, 11 ¼"



Fig. 2

35-751-12



Fig. 3

35-751-13



MC CLINTOCK

35-751-24 24,0 cm, 9 ½"

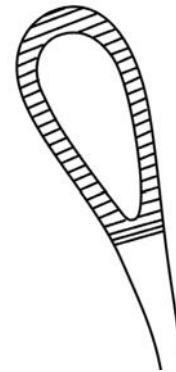

35-751-24



SAENGER

35-752-27 27,0 cm, 10³/₄"



SAENGER

35-753-27 27,0 cm, 10³/₄"

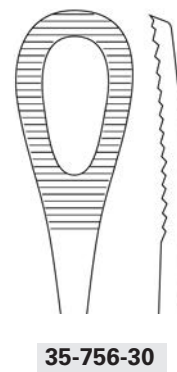
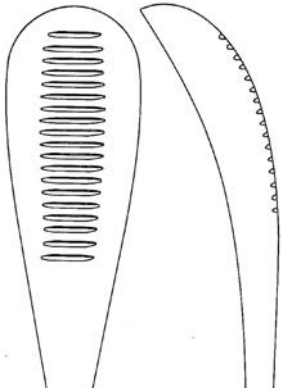

CUZZI

35-754-14 - 35-754-20 30,0 cm, 11 3/4"

PESTALOZZA

35-756-30 30,0 cm, 11 3/4"



36



Urologie

Urology

Urología

Urologia

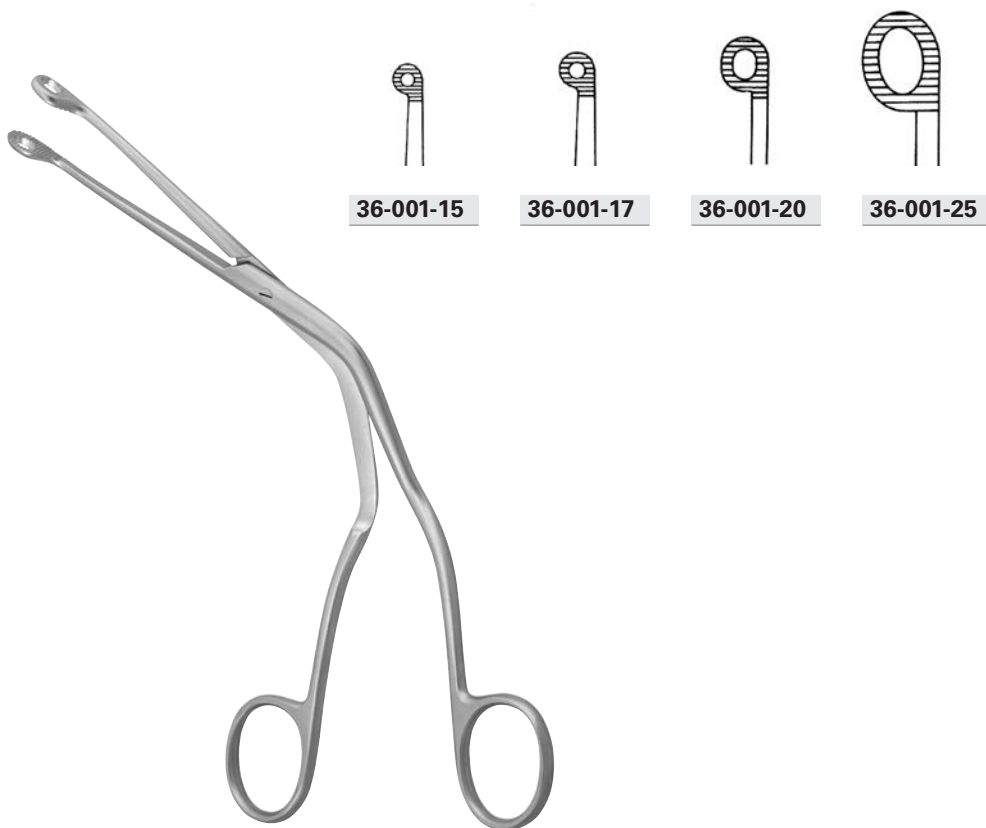

MAGILL

36-001-15	15,0 cm, 6 "
36-001-17	17,0 cm, 6 ³ / ₄ "
36-001-20	20,0 cm, 8 "
36-001-25	25,0 cm, 9 ³ / ₄ "

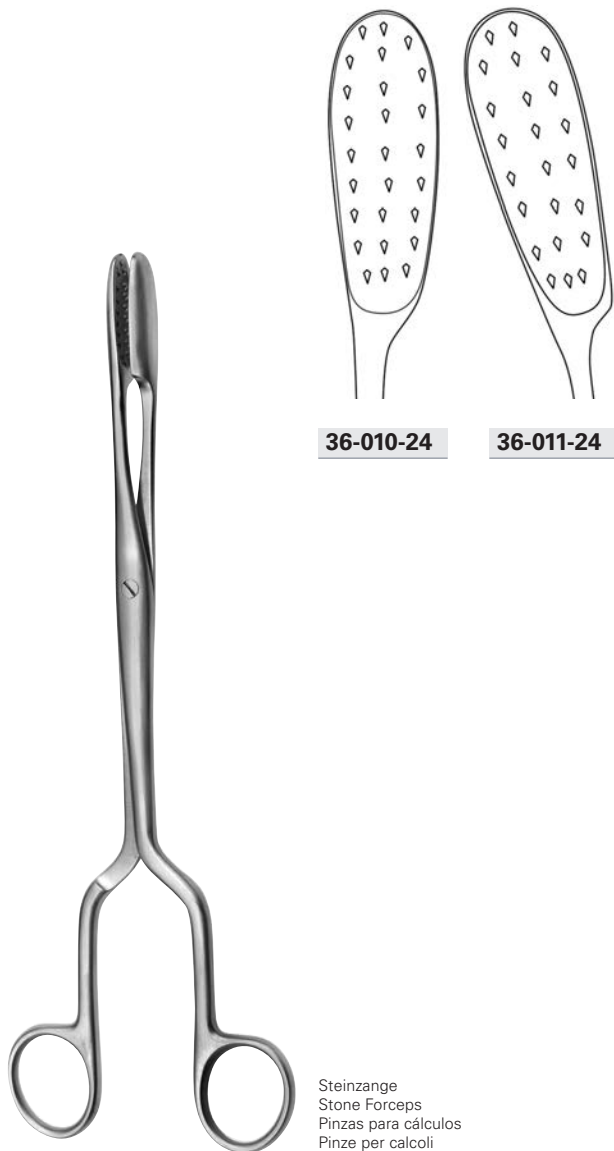

36-010-24

36-011-24

Steinzange
Stone Forceps
Pinzas para cálculos
Pinze per calcoli



Ureterzange
Urethro Forceps
Pinzas para uréter
Pinze per uretere

LEWKOWITZ

36-010-24 - 36-011-24 24,0 cm, 9 2/3 "

36-012-24 24,0 cm, 9 2/3 "



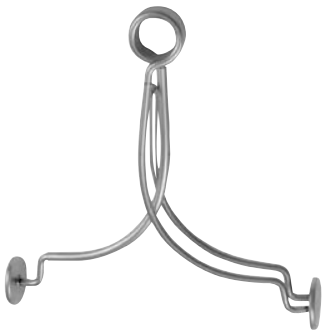

STOCKMANN

36-050-08 8,0 cm, 3 1/8"



STRAUSS

36-060-11 11,0 cm, 4 3/8"



Ø 4,8 mm

36-062-12



STOCKMANN

36-062-12 12,5 cm, 5"



36-064-14 14,5 cm, 5 3/4"



GUYON

36-070-39 39,0 cm, 15 1/2"

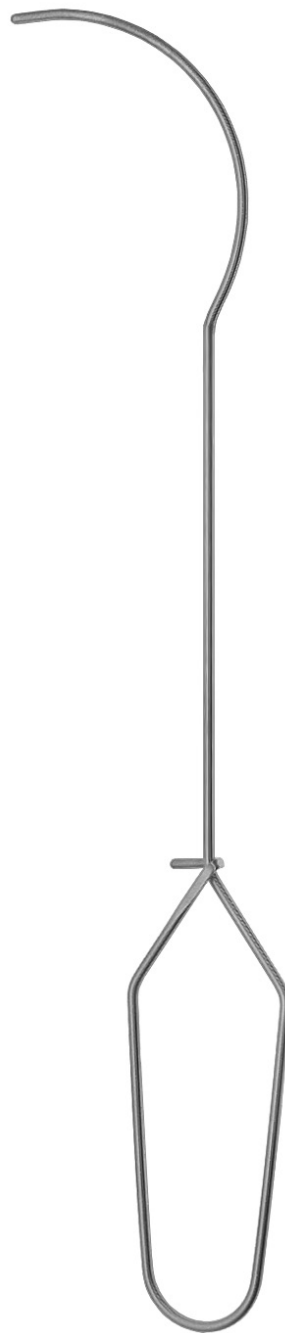

GUYON

36-071-35 35,0 cm, 13 3/4"

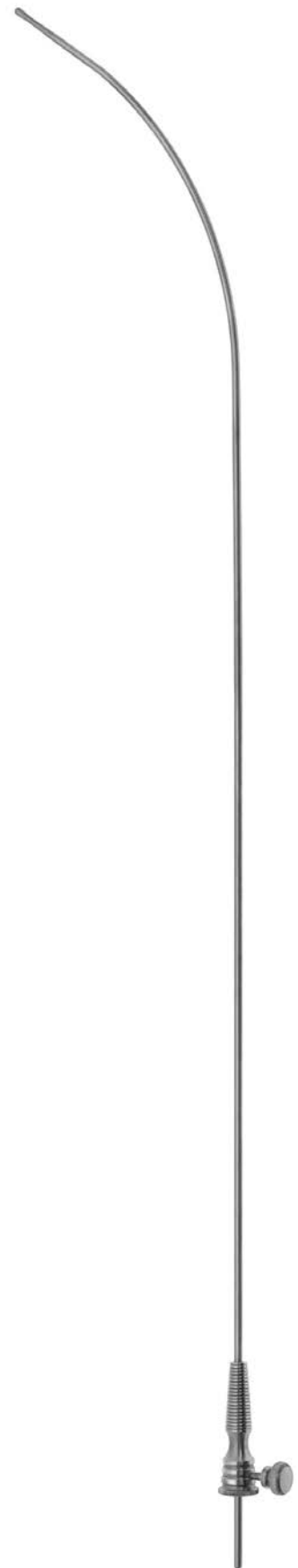

DITTEL

36-071-46 46,0 cm, 18"

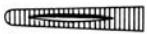
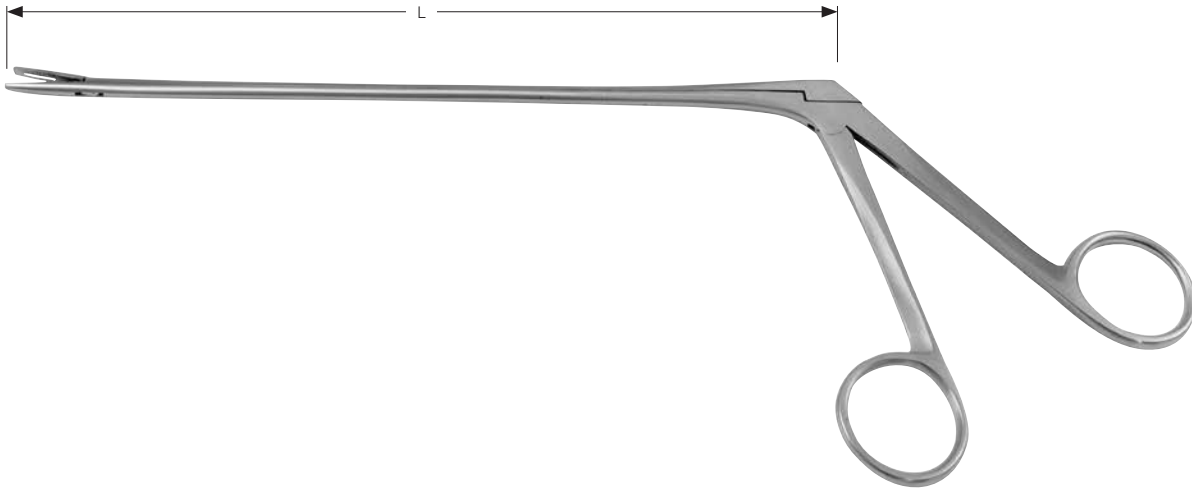

MATHIEU

36-080-19	19,0 cm, 7 1/2 "
36-080-28	28,0 cm, 11 "

Fremdkörperzangen
Foreign Body Forceps
Pinzas para cuerpos extraños
Pinze per corpi estranei

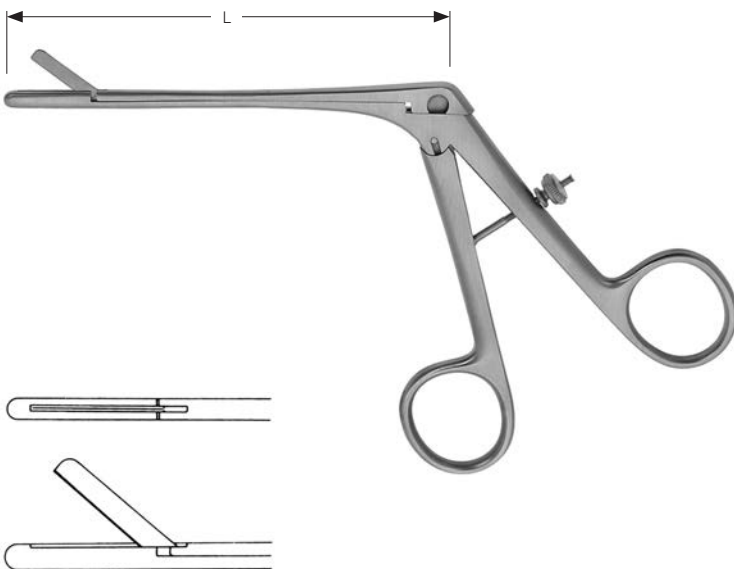

SACHSE

36-082-12	12,5 cm, 4 3/4 "
------------------	------------------

Meatotom
Meatotome
Meatotomo
Meatotomo



GUYON

36-100-00 SET

Satz mit 21 Bougies, Charr. 10 bis 30,
 mit 4 Gleitsonden, im Metalletui
 42,0 x 17,5 x 4,0 cm

Set with 21 bougies, Charr. 10 to 30,
 with 4 filiform bougies, in metal case
 42,0 x 17,5 x 4,0 cm

Juego de 21 bujías, Charr. 10 a 30,
 con 4 bujías filiformes, en caja metálica
 42,0 x 17,5 x 4,0 cm

Set di 21 dilatatori, Charr. 10 fino a 30,
 con 4 candelette dilatatrici, in contenitore
 metallico 42,0 x 17,5 x 4,0 cm

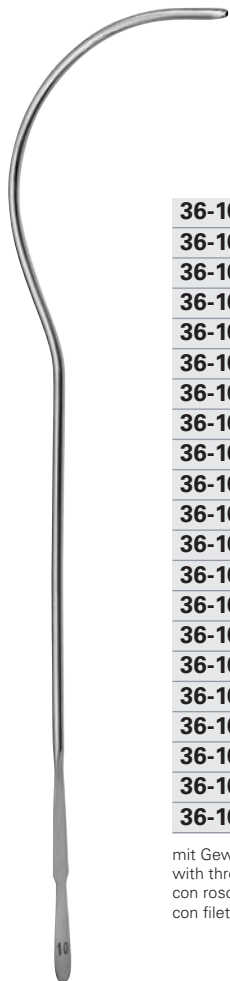

36-100-10	10 Charr.
36-100-11	11 Charr.
36-100-12	12 Charr.
36-100-13	13 Charr.
36-100-14	14 Charr.
36-100-15	15 Charr.
36-100-16	16 Charr.
36-100-17	17 Charr.
36-100-18	18 Charr.
36-100-19	19 Charr.
36-100-20	20 Charr.
36-100-21	21 Charr.
36-100-22	22 Charr.
36-100-23	23 Charr.
36-100-24	24 Charr.
36-100-25	25 Charr.
36-100-26	26 Charr.
36-100-27	27 Charr.
36-100-28	28 Charr.
36-100-29	29 Charr.
36-100-30	30 Charr.

mit Gewinde
 with thread
 con rosca
 con filetto

GUYON

36-100-10 - 36-100-30 26,0 cm, 10 1/4"



Verpackungseinheit: 5 St.
 Packing unit: 5 pieces
 Unidad: 5 piezas
 Confezione: 5 pezzi

36-101-03	3 Charr.
36-101-04	4 Charr.
36-101-05	5 Charr.
36-101-06	6 Charr.

mit Schraubgewinde-Ansatz
 with screw thread
 con rosca de tornillo
 con attacco filettato

FILIFORM

36-101-03 - 36-101-06



VAN BUREN

36-102-00 SET

Satz mit 26 Bougies, Charr. 8 bis 36
Set with 26 bougies, Charr. 8 to 36
Juego de 26 bujías, Charr. 8 a 36
Set di 26 dilatatori, Charr. 8 fino a 36

36-102-08	8 Charr.
36-102-09	9 Charr.
36-102-10	10 Charr.
36-102-11	11 Charr.
36-102-12	12 Charr.
36-102-13	13 Charr.
36-102-14	14 Charr.
36-102-15	15 Charr.
36-102-16	16 Charr.
36-102-17	17 Charr.
36-102-18	18 Charr.
36-102-19	19 Charr.
36-102-20	20 Charr.
36-102-21	21 Charr.
36-102-22	22 Charr.
36-102-23	23 Charr.
36-102-24	24 Charr.
36-102-25	25 Charr.
36-102-26	26 Charr.
36-102-27	27 Charr.
36-102-28	28 Charr.
36-102-29	29 Charr.
36-102-30	30 Charr.
36-102-32	32 Charr.
36-102-34	34 Charr.
36-102-36	36 Charr.

VAN BUREN

36-102-08 - 36-102-36 27,5 cm, 10³/₄"



36-104-00	0 2 E.G.
36-104-01	1 E.G.
36-104-02	1/2 3 E.G.
36-104-03	1 4 E.G.
36-104-04	2 5 E.G.
36-104-05	3 6 E.G.
36-104-06	4 7 E.G.
36-104-07	5 8 E.G.
36-104-08	6 9 E.G.
36-104-09	7 10 E.G.
36-104-10	8 11 E.G.
36-104-11	9 12 E.G.
36-104-12	10 13 E.G.
36-104-13	11 14 E.G.
36-104-14	12 15 E.G.
36-104-15	13 16 E.G.
36-104-16	14 17 E.G.
36-104-17	15 18 E.G.

LISTER

36-104-00 - 36-104-17 28,0 cm, 10³/₄"



36-110-06	6 Charr.
36-110-07	7 Charr.
36-110-08	8 Charr.
36-110-09	9 Charr.
36-110-10	10 Charr.
36-110-11	11 Charr.
36-110-12	12 Charr.
36-110-13	13 Charr.
36-110-14	14 Charr.
36-110-16	16 Charr.
36-110-18	18 Charr.
36-110-20	20 Charr.
36-110-22	22 Charr.
36-110-24	24 Charr.

für Frauen
 for women
 para mujeres
 per donne



36-112-08	8 Charr.
36-112-10	10 Charr.
36-112-12	12 Charr.
36-112-14	14 Charr.
36-112-16	16 Charr.
36-112-18	18 Charr.
36-112-20	20 Charr.

für Männer
 for men
 para hombres
 per uomini

36-110-06 - 36-110-24 15,0 cm, 6 "

36-112-08 - 36-112-20 25,0 cm, 10 "



LEGUEU

36-617-00 SET

LEGUEU

36-617-01

Blasenwundspreizer, allein
Bladder retractor, only
Separadores para la vejiga, sola
Divaricatori vescicali, sola

LEGUEU

36-617-10 30 x 85 mm

Mittelvalve, allein
Central blade, only
Valva central, sola
Valva centrale, sola

LEGUEU

36-617-11 30 x 63 mm

Seitenvalven Paar, allein
Lateral blades pair, only
Valvas laterales par, sola
Valve laterali paio, sola

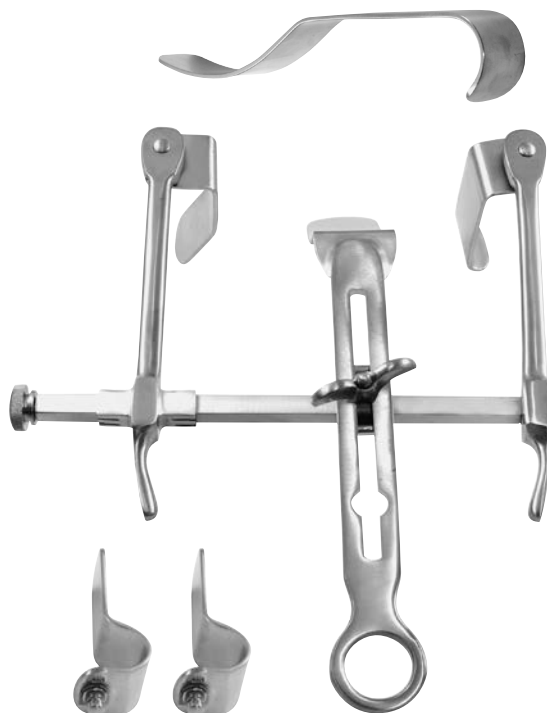

THOMSON-WALKER

36-618-00 SET



MILLIN

36-620-00 SET

MILLIN

36-620-01

Blasenwundspreizer, allein
Bladder retractor, only
Separadores para la vejiga, sola
Divaricatori vescicali, sola

MILLIN

36-620-02 110 x 45 mm

Mittelvalve, allein
Central blade, only
Valva central, sola
Valva centrale, sola

MILLIN

36-620-03 57 x 25 mm

36-620-04 80 x 25 mm

Seitenvalven Paar, allein
Lateral blades pair, only
Valvas laterales par, sola
Valve laterali paio, sola

Seitenvalven 25 x 70 mm
Lateral blades 25 x 70 mm
Valvas laterales 25 x 70 mm
Valve laterali 25 x 70 mm

Mittelvalve 24 x 84 mm
Central blade 24 x 84 mm
Valva central 24 x 84 mm
Valva centrale 24 x 84 mm

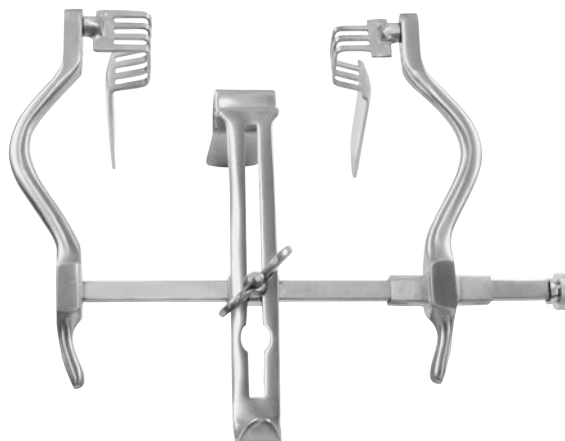

JUDD-MASSON

36-619-00 SET



Blasenspatel
 Bladder spatula
 Espátulas para la vesícula
 Spatole vescicali

LEGUEU

36-621-27 27,0 cm, 10 3/4"



36-621-27

Blasenhalsspreizer
 Bladder neck spreader
 Dilatador para el cuello vesical
 Dilatatore per collo vescicale

MILLIN

36-622-00 28,0 cm, 11"



67,0 mm

Blasenspatel
 Bladder spatula
 Espátulas para la vesícula
 Spatole vescicali

KOCHER

36-625-26 26,0 cm, 10 1/4"

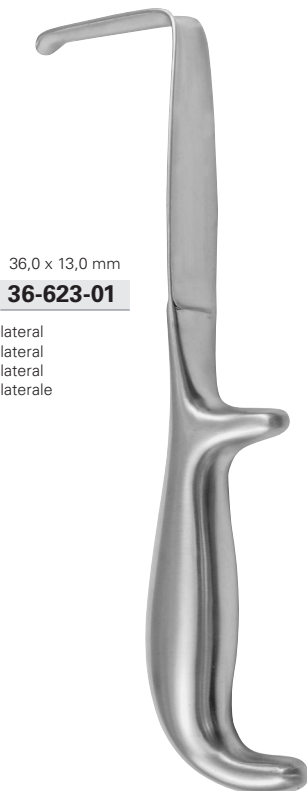

36,0 x 13,0 mm

36-623-01

lateral
 lateral
 lateral
 laterale

YOUNG

36-623-01 22,0 cm, 8 3/4"



68,0 x 38,0 mm

36-623-02

anterior
 anterior
 anterior
 anteriore

YOUNG

36-623-02 22,0 cm, 8 3/4"



23,0 x 25,0 mm

36-623-03

Bulbus-Haken
 Bulbus hook
 Gancho para el bulbus
 Bulbo ad uncino

YOUNG

36-623-03 22,0 cm, 8 3/4"



36,0 x 38,0 mm

36-623-04

gegabelt
 forked
 horquilla
 a forchetta

YOUNG

36-623-04 22,0 cm, 8 3/4"



OTIS

36-630-00 SET

Komplett in Holzetui,
bestehend aus:

1 Dilatator	36-630-01
2 Messer	36-630-02
1 Ansatz, konisch	36-630-03
1 Ansatz, flach	36-630-04
1 Ansatz, Kugel	36-630-05

Complete in wooden case,
consisting of:

1 Dilator	36-630-01
2 Knives	36-630-02
1 Tip, conical	36-630-03
1 Tip, flat	36-630-04
1 Tip, ball	36-630-05

Completo en estuche de madera,
compuesto de:

1 Dilatador	36-630-01
2 Cuchillos	36-630-02
1 Terminal, cónico	36-630-03
1 Terminal, plano	36-630-04
1 Terminal, esférico	36-630-05

Completo in astuccio di legno,
composto da:

1 Dilatore	36-630-01
2 Coltelli	36-630-02
1 Terminale, conico	36-630-03
1 Terminale, piatto	36-630-04
1 Terminale, sferico	36-630-05



36-630-03

Ansatz, konisch
Tip, conical
Terminal, cónico
Terminale, conico



36-630-04

Ansatz, flach
Tip, flat
Terminal, plano
Terminale, piatto



36-630-05

Ansatz, Kugel
Tip, ball
Terminal, esférico
Terminale, sferico



36-630-02

Messer
Knife
Cuchillo
Coltello



36-630-01

Dilatator
Dilator
Dilatador
Dilatatore



36-651-24



MILLIN

36-651-24 24,0 cm, 9 1/2"

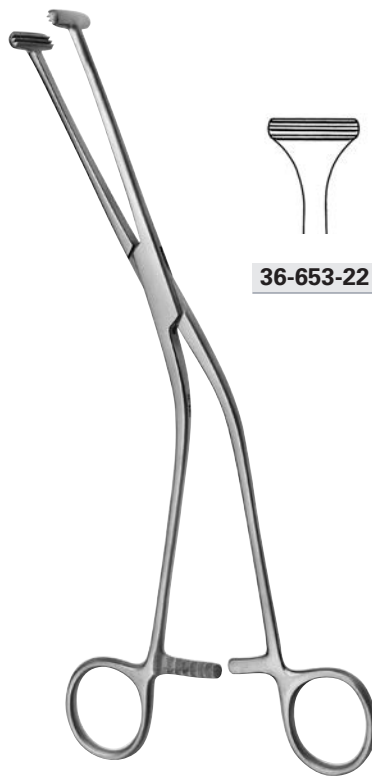

36-653-22

MILLIN

36-653-22 22,0 cm, 8 3/4"

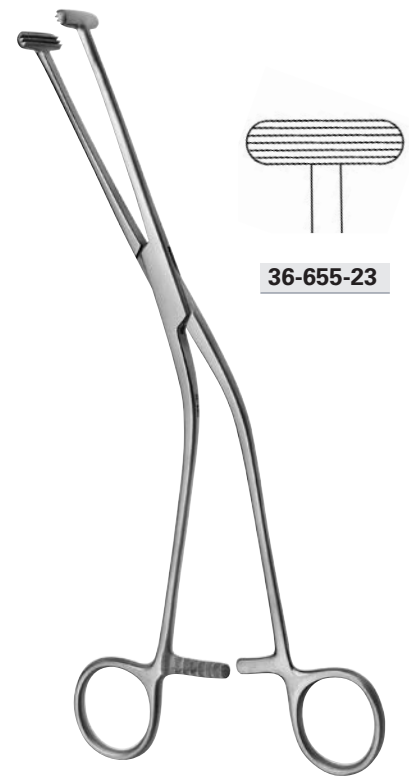

36-655-23

MILLIN

36-655-23 24,0 cm, 9 1/2"

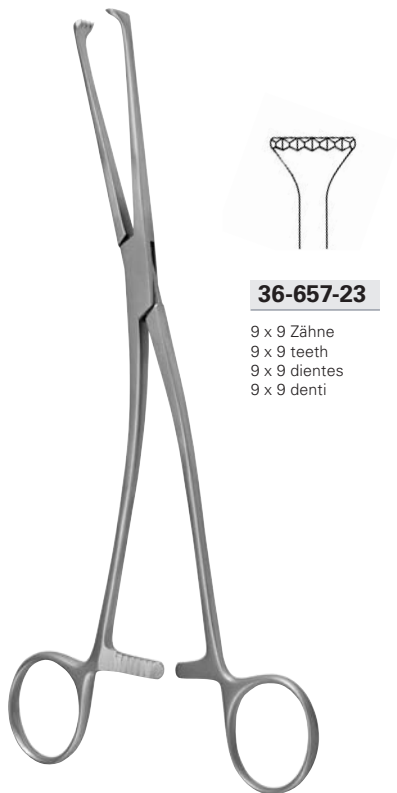

36-657-23

9 x 9 Zähne
 9 x 9 teeth
 9 x 9 dientes
 9 x 9 denti

MILLIN

36-657-23 23,0 cm, 9"



36-659-24

Fadenführzange
 Ligature guide forceps
 Pinza porta-ligaduras supra-pubiana
 Pinza portafilo

MILLIN

36-659-24 24,0 cm, 9 1/2"

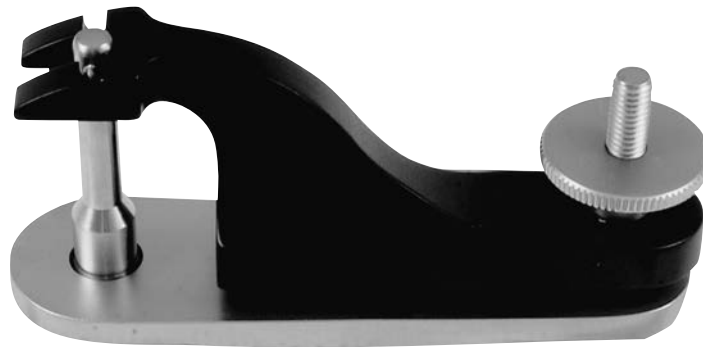

36-765-08 Ø 8,0 mm

für Säuglinge
for infants
para bebés
per neonati

36-765-11 Ø 11,0 mm

für Knaben
for boys
para niños
per bambini

36-765-13 Ø 13,0 mm

36-765-14 Ø 14,5 mm

für Jugendliche
for teenager
para adolescentes
per adolescenti

36-765-16 Ø 16,0 mm

36-765-21 Ø 21,0 mm

36-765-26 Ø 26,0 mm

für Männer
for men
para hombres
per uomini

36-765-32 Ø 32,0 mm



40



Knochenchirurgie

Bone Surgery

Cirurgía ósea

Chirurgia ossea

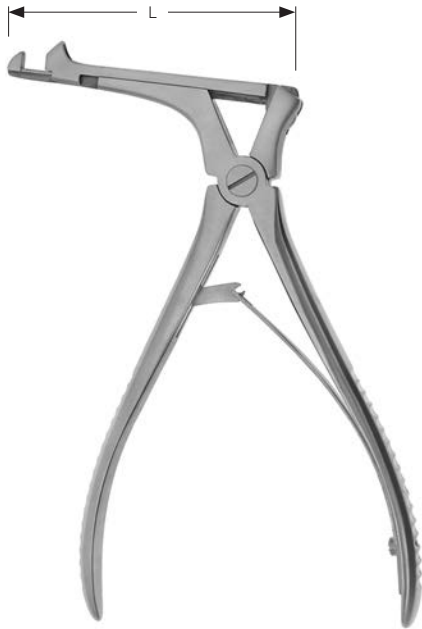

1,0 mm
40-000-15

2,0 mm
40-000-22

3,0 mm
40-000-30

90° nach oben schneidend
90° cutting upwards
cortante hacia arriba 90°
taglio a 90° verso l'alto

CITELLI

40-000-15 - 40-000-30 6,5 cm, 2 ½"

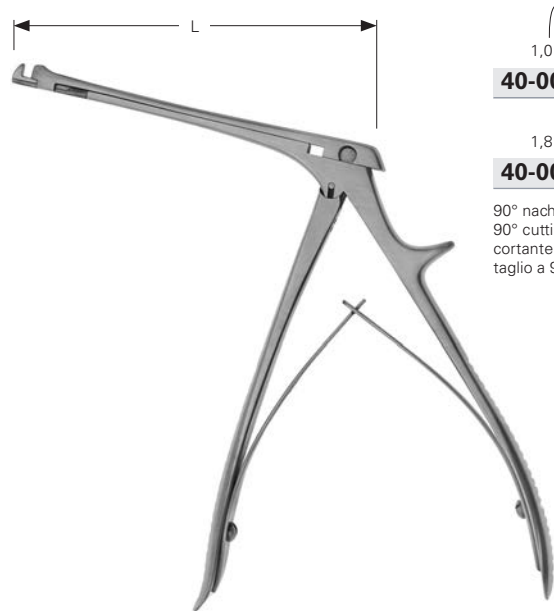

1,0 mm
40-002-10

1,8 mm
40-002-18

90° nach oben schneidend
90° cutting upwards
cortante hacia arriba 90°
taglio a 90° verso l'alto

CITELLI-BEYER

40-002-10 - 40-002-18 9,5 cm, 3 ¾"



3,0 mm
40-004-03

4,0 mm
40-004-04

5,0 mm
40-004-05

6,0 mm
40-004-06

90° nach oben schneidend
90° cutting upwards
cortante hacia arriba 90°
taglio a 90° verso l'alto

KERRISON

40-004-03 - 40-004-06 9,0 cm, 3 ½"



40-005-20

HAJEK-CLAUS

40-005-20 20,0 cm, 8"



40-006-33 3,3 mm

40-006-40 4,0 mm

90° nach oben schneidend
 90° cutting upwards
 cortante hacia arriba 90°
 taglio a 90° verso l'alto

40-007-33 3,3 mm

40-007-40 4,0 mm

90° nach unten schneidend
 90° cutting downwards
 cortante hacia abajo 90°
 taglio a 90° verso il basso

HAJEK-KOFLER

40-006-33 - 40-007-40 14,0 cm, 5 ½"

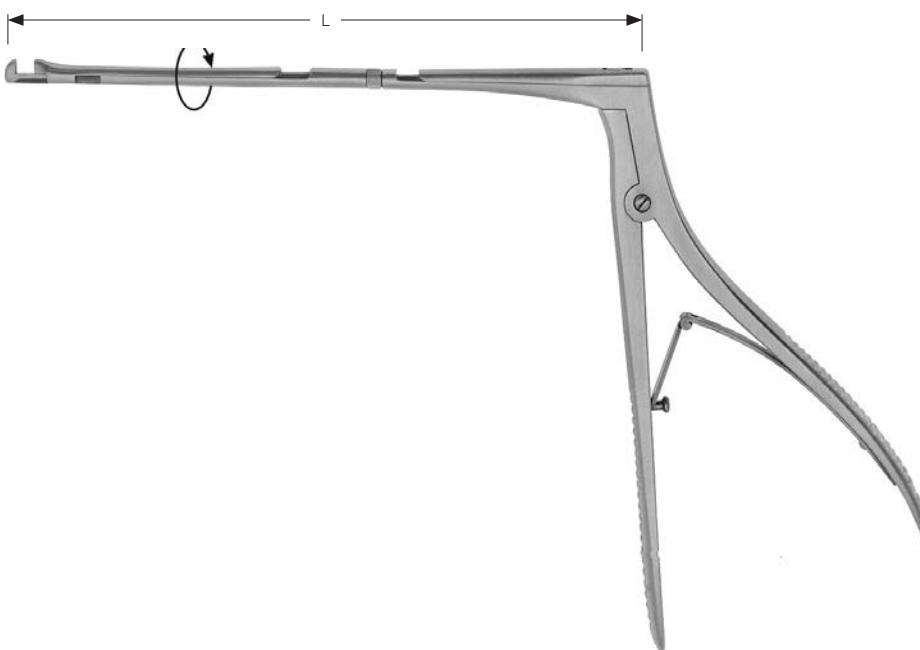

40-009-40 3,5 mm

90° schneidend, Schaft 360° drehbar
 90° cutting, shaft rotatable 360°
 corte 90°, vástago girable 360°
 taglio a 90°, albero rotante di 360°

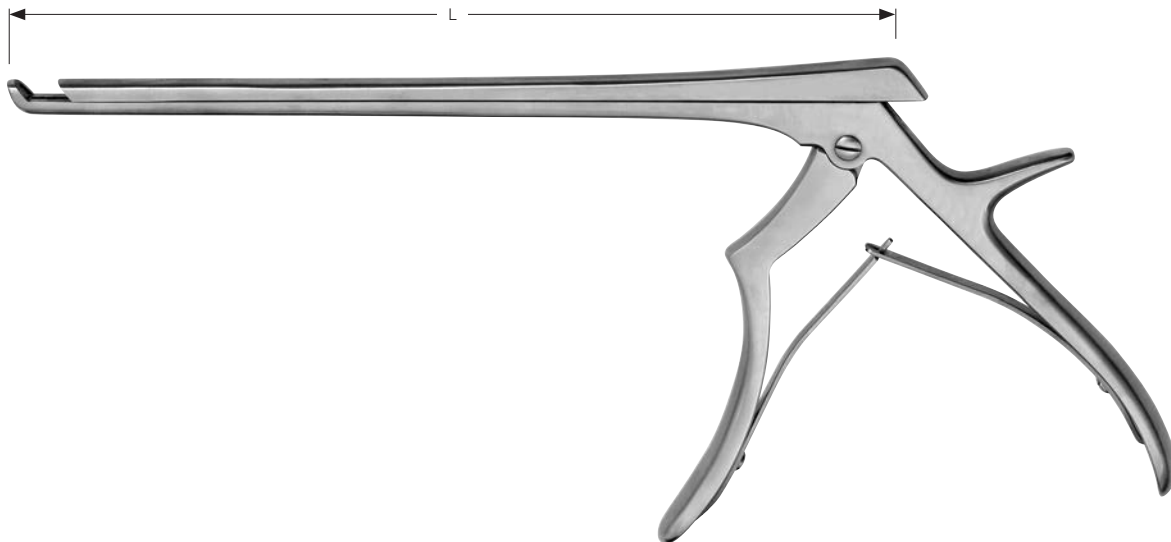

HAJEK-KOFLER

40-009-40 17,0 cm, 6 ¾"

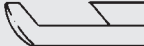

STEEL
STAINLESS

FERRIS-SMITH-KERRISON

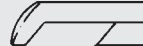
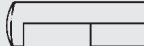
	L				
Bissbreite Width of bite Ancura de la boca Larghezza del morso	Schaftlänge Length of shaft Longitud del vástago Lunghezza dell'asta	40° nach oben 40° upwards 40° hacia arriba 40° verso l'alto	90° nach oben 90° upwards 90° hacia arriba 90° verso l'alto	40° nach unten 40° downwards 40° hacia abajo 40° verso il basso	90° nach unten 90° downwards 90° hacia abajo 90° il basso
1,0 mm	180 mm, 7"	40-014-01	40-016-01	40-017-01	40-019-01
2,0 mm	180 mm, 7"	40-014-02	40-016-02	40-017-02	40-019-02
3,0 mm	180 mm, 7"	40-014-03	40-016-03	40-017-03	40-019-03
4,0 mm	180 mm, 7"	40-014-04	40-016-04	40-017-04	40-019-04
5,0 mm	180 mm, 7"	40-014-05	40-016-05	40-017-05	40-019-05
6,0 mm	180 mm, 7"	40-014-06	40-016-06	40-017-06	40-019-06
1,0 mm	200 mm, 8"	40-014-11	40-016-11	40-017-11	40-019-11
2,0 mm	200 mm, 8"	40-014-12	40-016-12	40-017-12	40-019-12
3,0 mm	200 mm, 8"	40-014-13	40-016-13	40-017-13	40-019-13
4,0 mm	200 mm, 8"	40-014-14	40-016-14	40-017-14	40-019-14
5,0 mm	200 mm, 8"	40-014-15	40-016-15	40-017-15	40-019-15
6,0 mm	200 mm, 8"	40-014-16	40-016-16	40-017-16	40-019-16
1,0 mm	230 mm, 9"	40-014-21	40-016-21	40-017-21	40-019-21
2,0 mm	230 mm, 9"	40-014-22	40-016-22	40-017-22	40-019-22
3,0 mm	230 mm, 9"	40-014-23	40-016-23	40-017-23	40-019-23
4,0 mm	230 mm, 9"	40-014-24	40-016-24	40-017-24	40-019-24
5,0 mm	230 mm, 9"	40-014-25	40-016-25	40-017-25	40-019-25
6,0 mm	230 mm, 9"	40-014-26	40-016-26	40-017-26	40-019-26

Weitere Längen auf Anfrage
Other lengths on request
Otras longitudes bajo pedido
Ulteriori lunghezze su richiesta

STEEL
STAINLESS

STEEL
STAINLESS

STEEL
STAINLESS

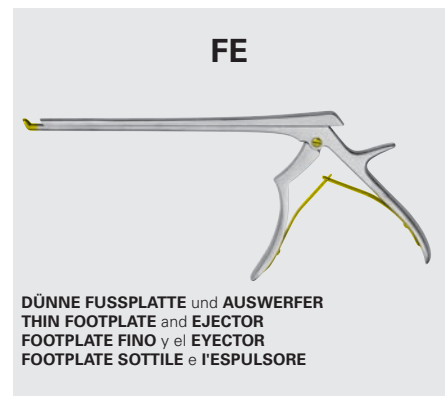
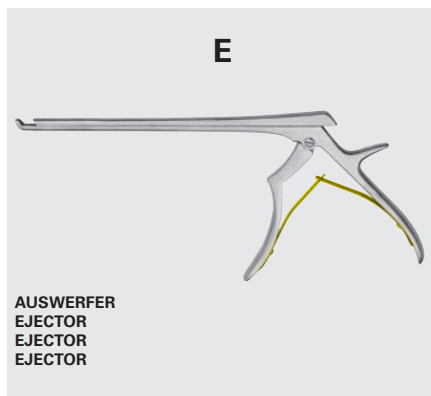
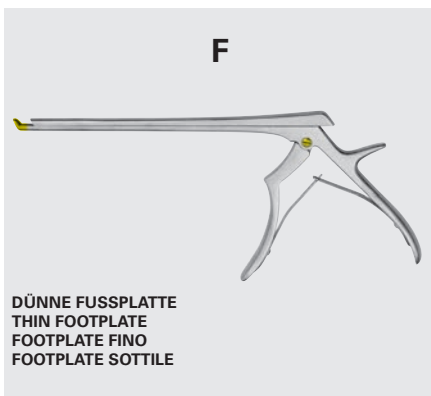

Für **AUSWERFER** fügen Sie ein "E" hinter die Artikelnummer (nicht möglich für 1 & 2 mm Stanzen)
 For **EJECTOR** please add "E" behind the item number (not available for 1 & 2 mm punches)
 Para el **EJECTOR** agregue por favor "E" detrás del número del artículo (no disponible para los sacadores de 1 y 2 mm)
 Per **EJECTOR** aggiunga prego la "E" dietro il numero dell'articolo (non disponibile per i punzoni da 1 & 2 mm)



Für **DÜNNE FUSSPLATTE** fügen Sie ein "F" hinter die Artikelnummer
 For **THIN FOOTPLATE** please add "F" behind the item number
 Para el **FOOTPLATE FINO** agregue por favor "F" detrás del número del artículo
 Per **FOOTPLATE SOTTILE** aggiunga prego la "F" dietro il numero dell'articolo



Für **DÜNNE FUSSPLATTE und AUSWERFER** (nicht möglich für 1 & 2 mm Stanzen) fügen Sie ein "FE" hinter die Artikelnummer
 For **THIN FOOTPLATE and EJECTOR** (not available for 1 & 2 mm punches) please add "FE" behind the item number
 Para **FOOTPLATE FINO y el EJECTOR** (no disponible para los sacadores de 1 y 2 mm) agregue por favor "FE" detrás del número del artículo
 Per **FOOTPLATE SOTTILE e l'ESPULSORE** (non disponibile per i punzoni da 1 & 2 mm) aggiunga prego la "FE" dietro il numero dell'articolo

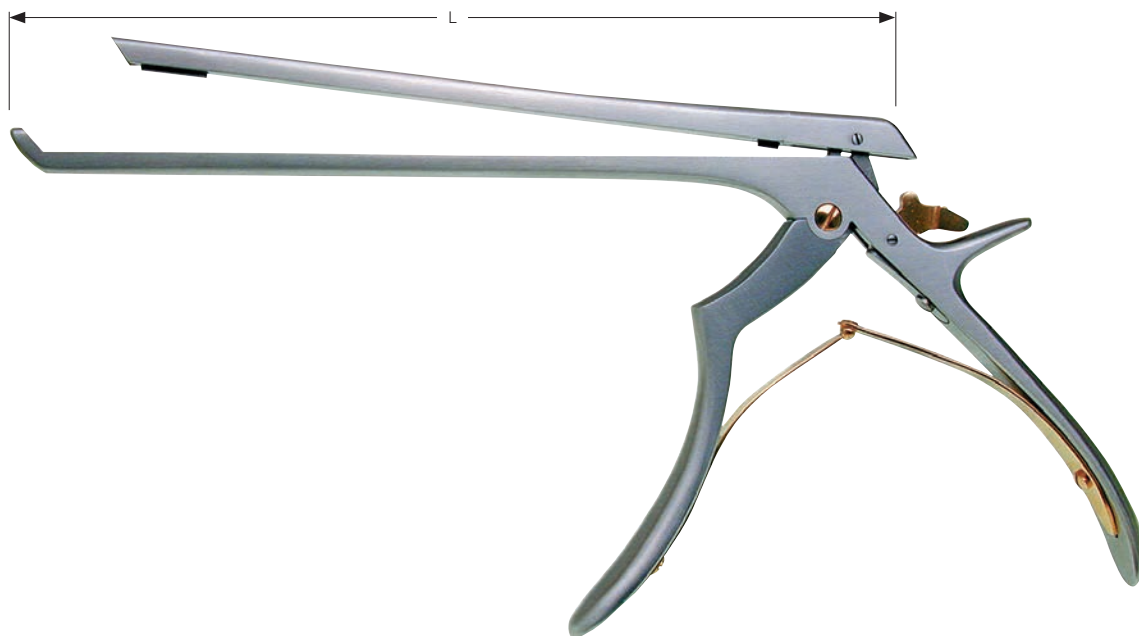

STEEL
STAINLESS

FERRIS-SMITH-KERRISON

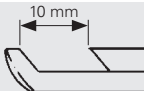
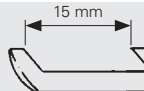
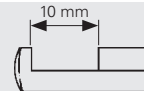
	L			
Bissbreite Width of bite Ancura de la boca Larghezza del morso	Schaftlänge Length of shaft Longitud del vástago Lunghezza dell'asta	40° nach oben 40° upwards 40° hacia arriba 40° verso l'alto	40° nach oben 40° upwards 40° hacia arriba 40° verso l'alto	90° nach oben 90° upwards 90° hacia arriba 90° verso l'alto
1,0 mm	180 mm, 7"	40-014-01 Z		40-016-01 Z
2,0 mm	180 mm, 7"	40-014-02 Z		40-016-02 Z
3,0 mm	180 mm, 7"	40-014-03 Z		40-016-03 ZE
4,0 mm	180 mm, 7"	40-014-04 Z		40-016-04 ZE
5,0 mm	180 mm, 7"	40-014-05 Z		40-016-05 ZE
6,0 mm	180 mm, 7"	40-014-06 Z		40-016-06 ZE
1,0 mm	200 mm, 8"	40-014-11 Z		40-016-11 Z
2,0 mm	200 mm, 8"	40-014-12 Z	40-015-12 ZF	40-016-12 Z
3,0 mm	200 mm, 8"	40-014-13 Z	40-015-13 ZF	40-016-13 ZE
4,0 mm	200 mm, 8"	40-014-14 Z	40-015-14 ZF	40-016-14 ZE
5,0 mm	200 mm, 8"	40-014-15 Z	40-015-15 ZF	40-016-15 ZE
6,0 mm	200 mm, 8"	40-014-16 Z		40-016-16 ZE
1,0 mm	230 mm, 9"	40-014-21 Z		40-016-21 Z
2,0 mm	230 mm, 9"	40-014-22 Z		40-016-22 Z
3,0 mm	230 mm, 9"	40-014-23 Z		40-016-23 ZE
4,0 mm	230 mm, 9"	40-014-24 Z		40-016-24 ZE
5,0 mm	230 mm, 9"	40-014-25 Z		40-016-25 ZE
6,0 mm	230 mm, 9"	40-014-26 Z		40-016-26 ZE

Weitere Längen auf Anfrage
Other lengths on request
Otras longitudes bajo pedido
Ulteriori lunghezze su richiesta

3,0 - 6,0 mm mit Auswerfer
3,0 - 6,0 mm with Ejector
3,0 - 6,0 mm con Ejector
3,0 - 6,0 mm con Ejector

STEEL
STAINLESS

STEEL
STAINLESS

STEEL
STAINLESS

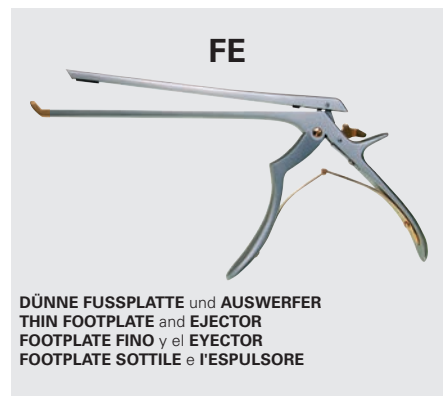
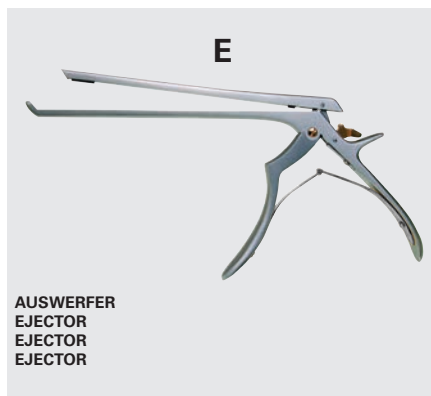
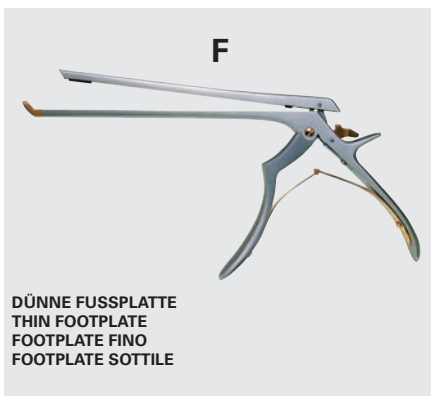

Für **AUSWERFER** fügen Sie ein "E" hinter die Artikelnummer (nicht möglich für 1 & 2 mm Stanzen & 40-015-12 ZF - 40-015-15 ZF)
 For **EJECTOR** please add "E" behind the item number (not available for 1 & 2 mm punches & 40-015-12 ZF - 40-015-15 ZF)
 Para el **EJECTOR** agregue por favor "E" detrás del número del artículo (no disponible para los sacadores de 1 y 2 mm & 40-015-12 ZF - 40-015-15 ZF)
 Per **EJECTOR** aggiunga prego la "E" dietro il numero dell'articolo (non disponibile per i punzoni da 1 & 2 mm & 40-015-12 ZF - 40-015-15 ZF)





Für **DÜNNE FUSSPLATTE** fügen Sie ein "F" hinter die Artikelnummer
 For **THIN FOOTPLATE** please add "F" behind the item number
 Para el **FOOTPLATE FINO** agregue por favor "F" detrás del número del artículo
 Per **FOOTPLATE SOTTILE** aggiunga prego la "F" dietro il numero dell'articolo

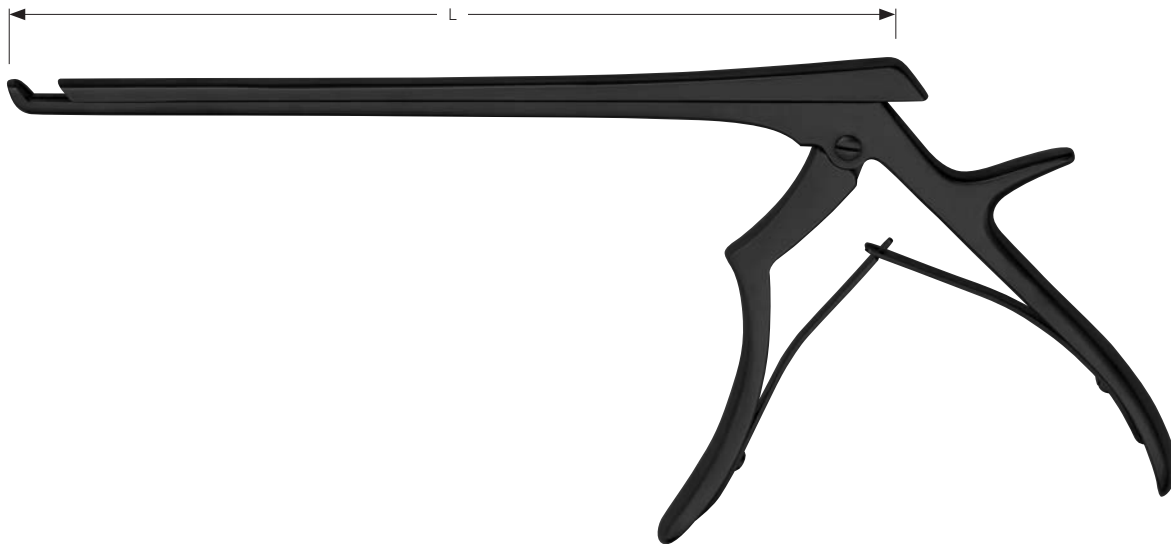

Für **DÜNNE FUSSPLATTE und AUSWERFER** (nicht möglich für 1 & 2 mm Stanzen & 40-015-12 ZF - 40-015-15 ZF) fügen Sie ein "FE" hinter die Artikelnummer
 For **THIN FOOTPLATE and EJECTOR** (not available for 1 & 2 mm punches & 40-015-12 ZF - 40-015-15 ZF) please add "FE" behind the item number
 Para **FOOTPLATE FINO y el EJECTOR** (no disponible para los sacadores de 1 y 2 mm & 40-015-12 ZF - 40-015-15 ZF) agregue por favor "FE" detrás del número del artículo
 Per **FOOTPLATE SOTTILE e l'ESPULSORE** (non disponibile per i punzoni da 1 & 2 mm & 40-015-12 ZF - 40-015-15 ZF) aggiunga prego la "FE" dietro il numero dell'articolo

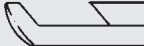

FERRIS-SMITH-KERRISON

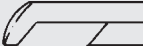
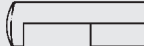
	L				
Bissbreite Width of bite Ancura de la boca Larghezza del morso	Schaftlänge Length of shaft Longitud del vástago Lunghezza dell'asta	40° nach oben 40° upwards 40° hacia arriba 40° verso l'alto	90° nach oben 90° upwards 90° hacia arriba 90° verso l'alto	40° nach unten 40° downwards 40° hacia abajo 40° verso il basso	90° nach unten 90° downwards 90° hacia abajo 90° il basso
1,0 mm	180 mm, 7"	40-014-01 B	40-016-01 B	40-017-01 B	40-019-01 B
2,0 mm	180 mm, 7"	40-014-02 B	40-016-02 B	40-017-02 B	40-019-02 B
3,0 mm	180 mm, 7"	40-014-03 B	40-016-03 B	40-017-03 B	40-019-03 B
4,0 mm	180 mm, 7"	40-014-04 B	40-016-04 B	40-017-04 B	40-019-04 B
5,0 mm	180 mm, 7"	40-014-05 B	40-016-05 B	40-017-05 B	40-019-05 B
6,0 mm	180 mm, 7"	40-014-06 B	40-016-06 B	40-017-06 B	40-019-06 B
1,0 mm	200 mm, 8"	40-014-11 B	40-016-11 B	40-017-11 B	40-019-11 B
2,0 mm	200 mm, 8"	40-014-12 B	40-016-12 B	40-017-12 B	40-019-12 B
3,0 mm	200 mm, 8"	40-014-13 B	40-016-13 B	40-017-13 B	40-019-13 B
4,0 mm	200 mm, 8"	40-014-14 B	40-016-14 B	40-017-14 B	40-019-14 B
5,0 mm	200 mm, 8"	40-014-15 B	40-016-15 B	40-017-15 B	40-019-15 B
6,0 mm	200 mm, 8"	40-014-16 B	40-016-16 B	40-017-16 B	40-019-16 B
1,0 mm	230 mm, 9"	40-014-21 B	40-016-21 B	40-017-21 B	40-019-21 B
2,0 mm	230 mm, 9"	40-014-22 B	40-016-22 B	40-017-22 B	40-019-22 B
3,0 mm	230 mm, 9"	40-014-23 B	40-016-23 B	40-017-23 B	40-019-23 B
4,0 mm	230 mm, 9"	40-014-24 B	40-016-24 B	40-017-24 B	40-019-24 B
5,0 mm	230 mm, 9"	40-014-25 B	40-016-25 B	40-017-25 B	40-019-25 B
6,0 mm	230 mm, 9"	40-014-26 B	40-016-26 B	40-017-26 B	40-019-26 B

Weitere Längen auf Anfrage
Other lengths on request
Otras longitudes bajo pedido
Ulteriori lunghezze su richiesta

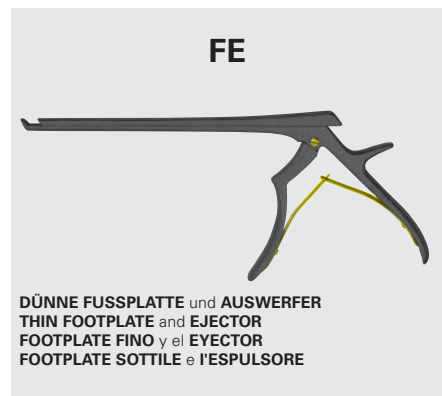
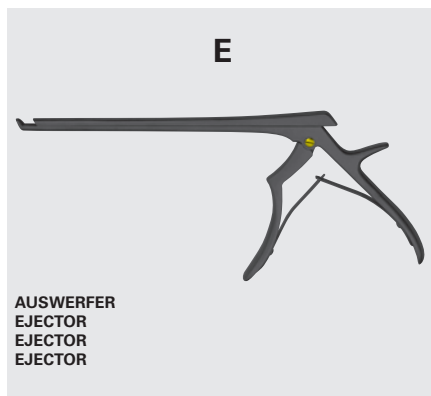
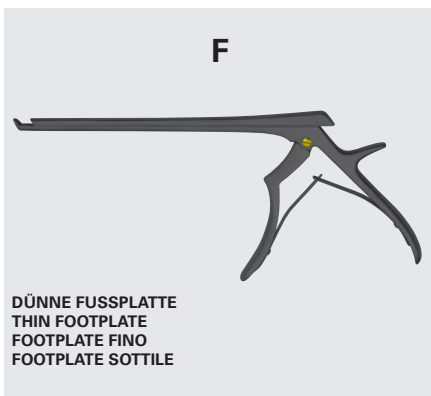

Für **AUSWERFER** fügen Sie ein "E" hinter die Artikelnummer (nicht möglich für 1 & 2 mm Stanzen)
 For **EJECTOR** please add "E" behind the item number (not available for 1 & 2 mm punches)
 Para el **EJECTOR** agregue por favor "E" detrás del número del artículo (no disponible para los sacadores de 1 y 2 mm)
 Per **EJECTOR** aggiunga prego la "E" dietro il numero dell'articolo (non disponibile per i punzoni da 1 & 2 mm)



Für **DÜNNE FUSSPLATTE** fügen Sie ein "F" hinter die Artikelnummer
 For **THIN FOOTPLATE** please add "F" behind the item number
 Para el **FOOTPLATE FINO** agregue por favor "F" detrás del número del artículo
 Per **FOOTPLATE SOTTILE** aggiunga prego la "F" dietro il numero dell'articolo



Für **DÜNNE FUSSPLATTE und AUSWERFER** (nicht möglich für 1 & 2 mm Stanzen) fügen Sie ein "FE" hinter die Artikelnummer
 For **THIN FOOTPLATE and EJECTOR** (not available for 1 & 2 mm punches) please add "FE" behind the item number
 Para **FOOTPLATE FINO y el EJECTOR** (no disponible para los sacadores de 1 y 2 mm) agregue por favor "FE" detrás del número del artículo
 Per **FOOTPLATE SOTTILE e l'ESPULSORE** (non disponibile per i punzoni da 1 & 2 mm) aggiunga prego la "FE" dietro il numero dell'articolo

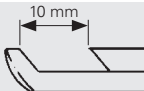
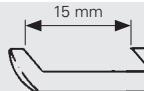
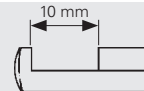

FERRIS-SMITH-KERRISON

	L			
Bissbreite Width of bite Ancura de la boca Larghezza del morso	Schaftlänge Length of shaft Longitud del vástago Lunghezza dell'asta	40° nach oben 40° upwards 40° hacia arriba 40° verso l'alto	40° nach oben 40° upwards 40° hacia arriba 40° verso l'alto	90° nach oben 90° upwards 90° hacia arriba 90° verso l'alto
1,0 mm	180 mm, 7"	40-014-01 ZB		40-016-01 ZB
2,0 mm	180 mm, 7"	40-014-02 ZB		40-016-02 ZB
3,0 mm	180 mm, 7"	40-014-03 ZB		40-016-03 ZBE
4,0 mm	180 mm, 7"	40-014-04 ZB		40-016-04 ZBE
5,0 mm	180 mm, 7"	40-014-05 ZB		40-016-05 ZBE
6,0 mm	180 mm, 7"	40-014-06 ZB		40-016-06 ZBE
1,0 mm	200 mm, 8"	40-014-11 ZB		40-016-11 ZB
2,0 mm	200 mm, 8"	40-014-12 ZB	40-015-12 ZBF	40-016-12 ZB
3,0 mm	200 mm, 8"	40-014-13 ZB	40-015-13 ZBF	40-016-13 ZBE
4,0 mm	200 mm, 8"	40-014-14 ZB	40-015-14 ZBF	40-016-14 ZBE
5,0 mm	200 mm, 8"	40-014-15 ZB	40-015-15 ZBF	40-016-15 ZBE
6,0 mm	200 mm, 8"	40-014-16 ZB		40-016-16 ZBE
1,0 mm	230 mm, 9"	40-014-21 ZB		40-016-21 ZB
2,0 mm	230 mm, 9"	40-014-22 ZB		40-016-22 ZB
3,0 mm	230 mm, 9"	40-014-23 ZB		40-016-23 ZBE
4,0 mm	230 mm, 9"	40-014-24 ZB		40-016-24 ZBE
5,0 mm	230 mm, 9"	40-014-25 ZB		40-016-25 ZBE
6,0 mm	230 mm, 9"	40-014-26 ZB		40-016-26 ZBE

Weitere Längen auf Anfrage
Other lengths on request
Otras longitudes bajo pedido
Ulteriori lunghezze su richiesta

3,0 - 6,0 mm mit Auswerfer
3,0 - 6,0 mm with Ejector
3,0 - 6,0 mm con Ejector
3,0 - 6,0 mm con Ejector

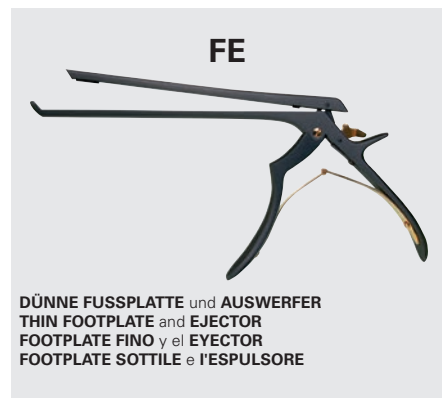
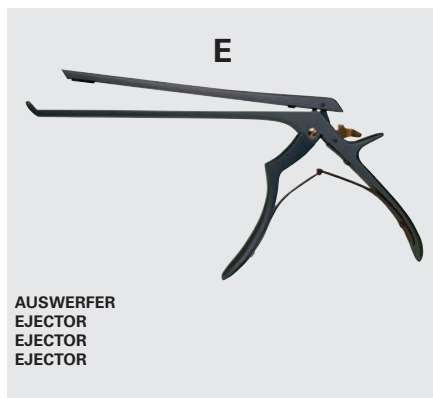
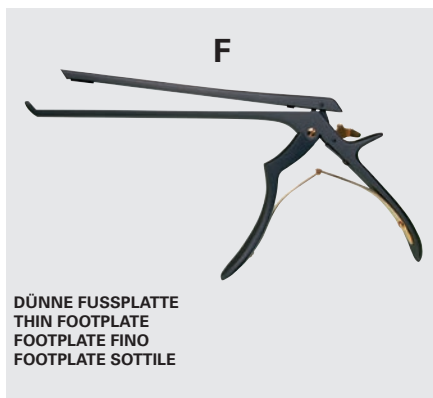

Für **AUSWERFER** fügen Sie ein "E" hinter die Artikelnummer (nicht möglich für 1 & 2 mm Stanzen & 40-015-12 ZF - 40-015-15 ZF)
 For **EJECTOR** please add "E" behind the item number (not available for 1 & 2 mm punches & 40-015-12 ZF - 40-015-15 ZF)
 Para el **EJECTOR** agregue por favor "E" detrás del número del artículo (no disponible para los sacadores de 1 y 2 mm & 40-015-12 ZF - 40-015-15 ZF)
 Per **EJECTOR** aggiunga prego la "E" dietro il numero dell'articolo (non disponibile per i punzoni da 1 & 2 mm & 40-015-12 ZF - 40-015-15 ZF)



Für **DÜNNE FUSSPLATTE** fügen Sie ein "F" hinter die Artikelnummer
 For **THIN FOOTPLATE** please add "F" behind the item number
 Para el **FOOTPLATE FINO** agregue por favor "F" detrás del número del artículo
 Per **FOOTPLATE SOTTILE** aggiunga prego la "F" dietro il numero dell'articolo



Für **DÜNNE FUSSPLATTE und AUSWERFER** (nicht möglich für 1 & 2 mm Stanzen & 40-015-12 ZF - 40-015-15 ZF) fügen Sie ein "FE" hinter die Artikelnummer
 For **THIN FOOTPLATE and EJECTOR** (not available for 1 & 2 mm punches & 40-015-12 ZF - 40-015-15 ZF) please add "FE" behind the item number
 Para **FOOTPLATE FINO y el EJECTOR** (no disponible para los sacadores de 1 y 2 mm & 40-015-12 ZF - 40-015-15 ZF) agregue por favor "FE" detrás del número del artículo
 Per **FOOTPLATE SOTTILE e l'ESPULSORE** (non disponibile per i punzoni da 1 & 2 mm & 40-015-12 ZF - 40-015-15 ZF) aggiunga prego la "FE" dietro il numero dell'articolo

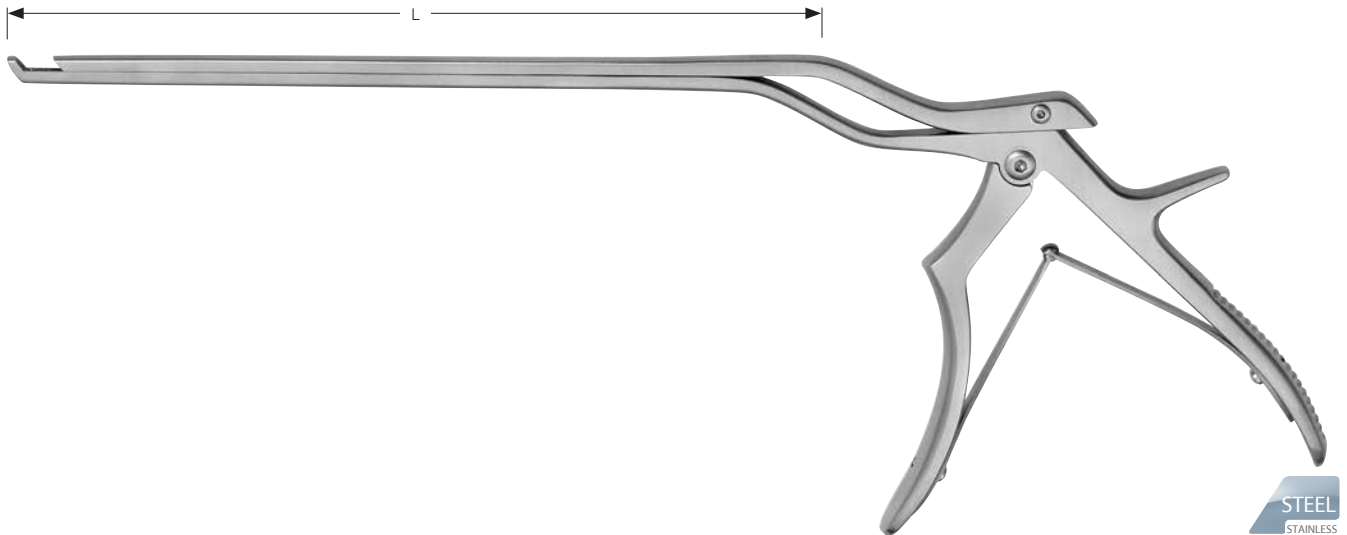

BAYONET-KERRISON

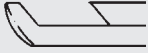
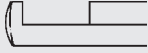
	L		
Bissbreite Width of bite Ancura de la boca Larghezza del morso	Schaftlänge Length of shaft Longitud del vástago Lunghezza dell'asta	40° nach oben 40° upwards 40° hacia arriba 40° verso l'alto	90° nach oben 90° upwards 90° hacia arriba 90° verso l'alto
1,0 mm	110 mm, 4 3/8"	40-020-01	40-021-01
2,0 mm	110 mm, 4 3/8"	40-020-02	40-021-02
3,0 mm	110 mm, 4 3/8"	40-020-03	40-021-03
4,0 mm	110 mm, 4 3/8"	40-020-04	40-021-04
5,0 mm	110 mm, 4 3/8"	40-020-05	40-021-05
6,0 mm	110 mm, 4 3/8"	40-020-06	40-021-06
1,0 mm	150 mm, 6"	40-020-11	40-021-11
2,0 mm	150 mm, 6"	40-020-12	40-021-12
3,0 mm	150 mm, 6"	40-020-13	40-021-13
4,0 mm	150 mm, 6"	40-020-14	40-021-14
5,0 mm	150 mm, 6"	40-020-15	40-021-15
6,0 mm	150 mm, 6"	40-020-16	40-021-16
1,0 mm	180 mm, 7"	40-020-21	40-021-21
2,0 mm	180 mm, 7"	40-020-22	40-021-22
3,0 mm	180 mm, 7"	40-020-23	40-021-23
4,0 mm	180 mm, 7"	40-020-24	40-021-24
5,0 mm	180 mm, 7"	40-020-25	40-021-25
6,0 mm	180 mm, 7"	40-020-26	40-021-26

Weitere Längen auf Anfrage
Other lengths on request
Otras longitudes bajo pedido
Ulteriori lunghezze su richiesta

STEEL
STAINLESS

STEEL
STAINLESS

STEEL
STAINLESS

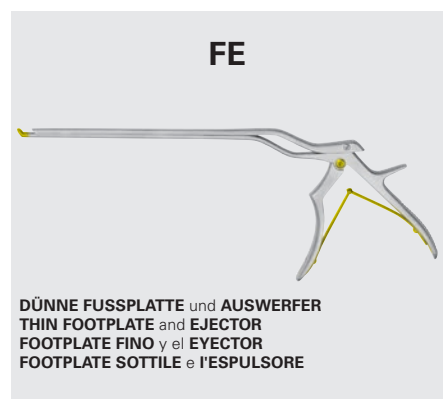
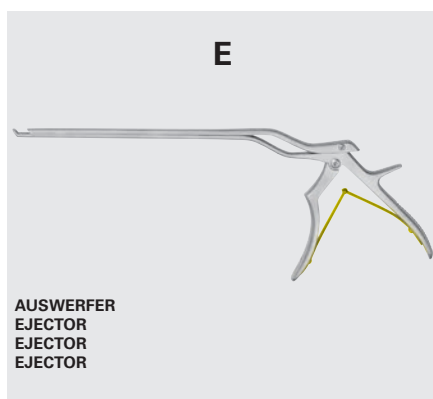
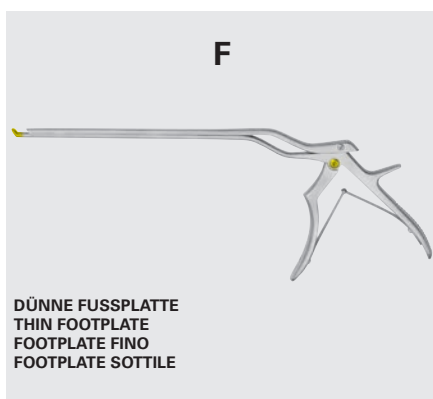

Für **AUSWERFER** fügen Sie ein "E" hinter die Artikelnummer (nicht möglich für 1 & 2 mm Stanzen)
 For **EJECTOR** please add "E" behind the item number (not available for 1 & 2 mm punches)
 Para el **EJECTOR** agregue por favor "E" detrás del número del artículo (no disponible para los sacadores de 1 y 2 mm)
 Per **EJECTOR** aggiunga prego la "E" dietro il numero dell'articolo (non disponibile per i punzoni da 1 & 2 mm)





Für **DÜNNE FUSSPLATTE** fügen Sie ein "F" hinter die Artikelnummer
 For **THIN FOOTPLATE** please add "F" behind the item number
 Para el **FOOTPLATE FINO** agregue por favor "F" detrás del número del artículo
 Per **FOOTPLATE SOTTILE** aggiunga prego la "F" dietro il numero dell'articolo

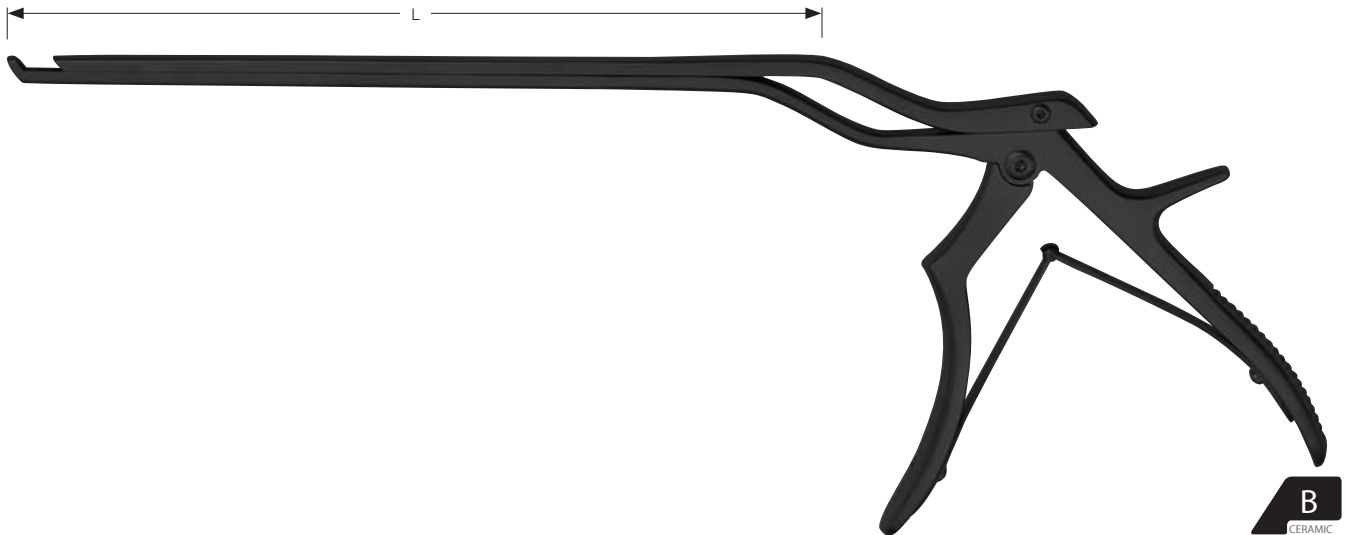

Für **DÜNNE FUSSPLATTE und AUSWERFER** (nicht möglich für 1 & 2 mm Stanzen) fügen Sie ein "FE" hinter die Artikelnummer
 For **THIN FOOTPLATE and EJECTOR** (not available for 1 & 2 mm punches) please add "FE" behind the item number
 Para **FOOTPLATE FINO y el EJECTOR** (no disponible para los sacadores de 1 y 2 mm) agregue por favor "FE" detrás del número del artículo
 Per **FOOTPLATE SOTTILE e l'ESPULSORE** (non disponibile per i punzoni da 1 & 2 mm) aggiunga prego la "FE" dietro il numero dell'articolo

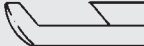

BAYONET-KERRISON

	L		
Bissbreite Width of bite Ancura de la boca Larghezza del morso	Schaftlänge Length of shaft Longitud del vástago Lunghezza dell'asta	40° nach oben 40° upwards 40° hacia arriba 40° verso l'alto	90° nach oben 90° upwards 90° hacia arriba 90° verso l'alto
1,0 mm	110 mm, 4 3/8"	40-020-01 B	40-021-01 B
2,0 mm	110 mm, 4 3/8"	40-020-02 B	40-021-02 B
3,0 mm	110 mm, 4 3/8"	40-020-03 B	40-021-03 B
4,0 mm	110 mm, 4 3/8"	40-020-04 B	40-021-04 B
5,0 mm	110 mm, 4 3/8"	40-020-05 B	40-021-05 B
6,0 mm	110 mm, 4 3/8"	40-020-06 B	40-021-06 B
1,0 mm	150 mm, 6"	40-020-11 B	40-021-11 B
2,0 mm	150 mm, 6"	40-020-12 B	40-021-12 B
3,0 mm	150 mm, 6"	40-020-13 B	40-021-13 B
4,0 mm	150 mm, 6"	40-020-14 B	40-021-14 B
5,0 mm	150 mm, 6"	40-020-15 B	40-021-15 B
6,0 mm	150 mm, 6"	40-020-16 B	40-021-16 B
1,0 mm	180 mm, 7"	40-020-21 B	40-021-21 B
2,0 mm	180 mm, 7"	40-020-22 B	40-021-22 B
3,0 mm	180 mm, 7"	40-020-23 B	40-021-23 B
4,0 mm	180 mm, 7"	40-020-24 B	40-021-24 B
5,0 mm	180 mm, 7"	40-020-25 B	40-021-25 B
6,0 mm	180 mm, 7"	40-020-26 B	40-021-26 B

Weitere Längen auf Anfrage
Other lengths on request
Otras longitudes bajo pedido
Ulteriori lunghezze su richiesta

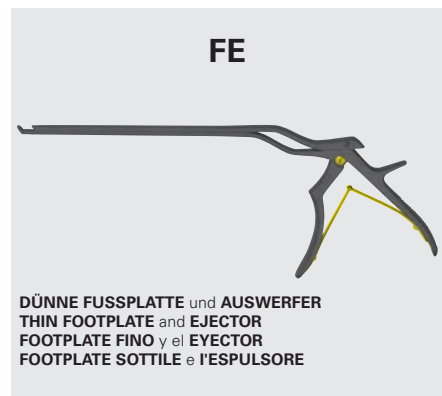
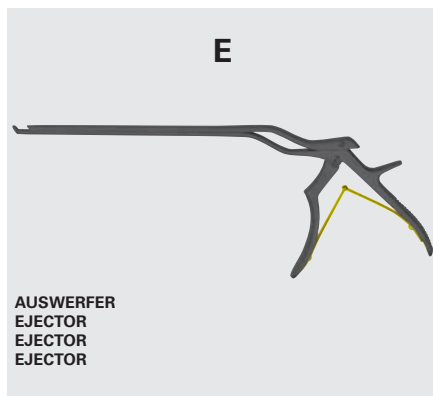
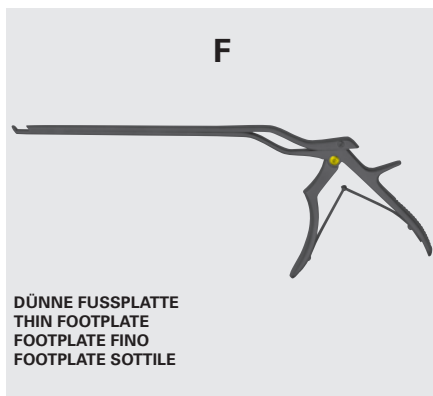

Für **AUSWERFER** fügen Sie ein "E" hinter die Artikelnummer (nicht möglich für 1 & 2 mm Stanzen)
 For **EJECTOR** please add "E" behind the item number (not available for 1 & 2 mm punches)
 Para el **EJECTOR** agregue por favor "E" detrás del número del artículo (no disponible para los sacadores de 1 y 2 mm)
 Per **EJECTOR** aggiunga prego la "E" dietro il numero dell'articolo (non disponibile per i punzoni da 1 & 2 mm)



Für **DÜNNE FUSSPLATTE** fügen Sie ein "F" hinter die Artikelnummer
 For **THIN FOOTPLATE** please add "F" behind the item number
 Para el **FOOTPLATE FINO** agregue por favor "F" detrás del número del artículo
 Per **FOOTPLATE SOTTILE** aggiunga prego la "F" dietro il numero dell'articolo



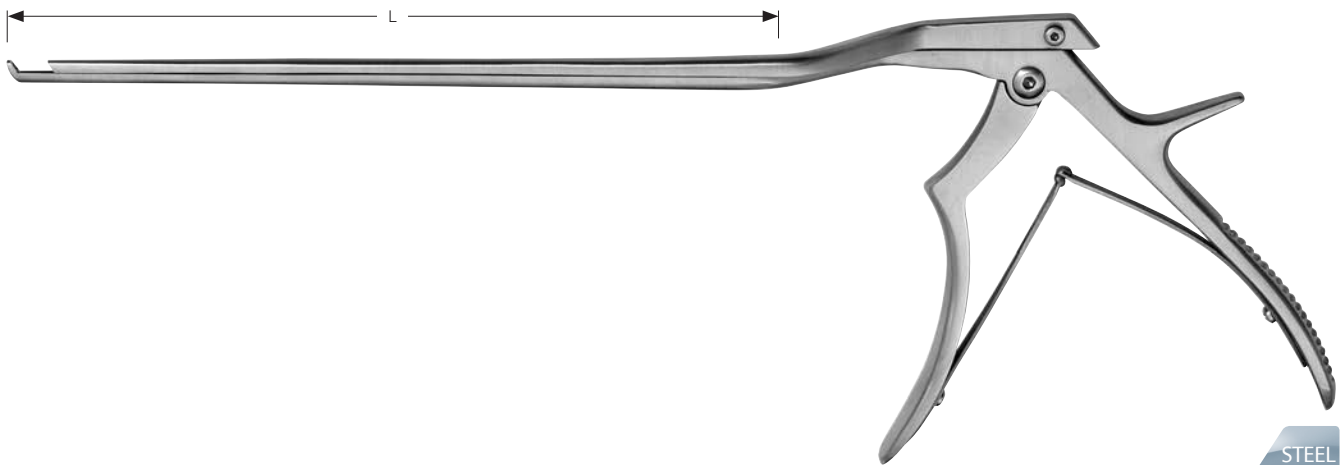

Für **DÜNNE FUSSPLATTE und AUSWERFER** (nicht möglich für 1 & 2 mm Stanzen) fügen Sie ein "FE" hinter die Artikelnummer
 For **THIN FOOTPLATE and EJECTOR** (not available for 1 & 2 mm punches) please add "FE" behind the item number
 Para **FOOTPLATE FINO y el EJECTOR** (no disponible para los sacadores de 1 y 2 mm) agregue por favor "FE" detrás del número del artículo
 Per **FOOTPLATE SOTTILE e l'ESPULSORE** (non disponibile per i punzoni da 1 & 2 mm) aggiunga prego la "FE" dietro il numero dell'articolo

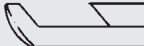
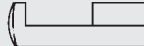

STEEL
STAINLESS

BAYONET-KERRISON

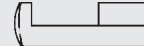
	L	links left izquierda sinistra		rechts right derecha destra	
					
Bissbreite Width of bite Ancura de la boca Larghezza del morso	Schaftlänge Length of shaft Longitud del vástago Lunghezza dell'asta	40° nach oben 40° upwards 40° hacia arriba 40° verso l'alto	90° nach oben 90° upwards 90° hacia arriba 90° verso l'alto	40° nach oben 40° upwards 40° hacia arriba 40° verso l'alto	90° nach oben 90° upwards 90° hacia arriba 90° verso l'alto
1,0 mm	110 mm, 4 3/8"	40-022-01	40-023-01	40-022-31	40-023-31
2,0 mm	110 mm, 4 3/8"	40-022-02	40-023-02	40-022-32	40-023-32
3,0 mm	110 mm, 4 3/8"	40-022-03	40-023-03	40-022-33	40-023-33
4,0 mm	110 mm, 4 3/8"	40-022-04	40-023-04	40-022-34	40-023-34
5,0 mm	110 mm, 4 3/8"	40-022-05	40-023-05	40-022-35	40-023-35
6,0 mm	110 mm, 4 3/8"	40-022-06	40-023-06	40-022-36	40-023-36
1,0 mm	150 mm, 6"	40-022-11	40-023-11	40-022-41	40-023-41
2,0 mm	150 mm, 6"	40-022-12	40-023-12	40-022-42	40-023-42
3,0 mm	150 mm, 6"	40-022-13	40-023-13	40-022-43	40-023-43
4,0 mm	150 mm, 6"	40-022-14	40-023-14	40-022-44	40-023-44
5,0 mm	150 mm, 6"	40-022-15	40-023-15	40-022-45	40-023-45
6,0 mm	150 mm, 6"	40-022-16	40-023-16	40-022-46	40-023-46
1,0 mm	180 mm, 7"	40-022-21	40-023-21	40-022-51	40-023-51
2,0 mm	180 mm, 7"	40-022-22	40-023-22	40-022-52	40-023-52
3,0 mm	180 mm, 7"	40-022-23	40-023-23	40-022-53	40-023-53
4,0 mm	180 mm, 7"	40-022-24	40-023-24	40-022-54	40-023-54
5,0 mm	180 mm, 7"	40-022-25	40-023-25	40-022-55	40-023-55
6,0 mm	180 mm, 7"	40-022-26	40-023-26	40-022-56	40-023-56

Weitere Längen auf Anfrage
Other lengths on request
Otras longitudes bajo pedido
Ulteriori lunghezze su richiesta

STEEL
STAINLESS

STEEL
STAINLESS

STEEL
STAINLESS

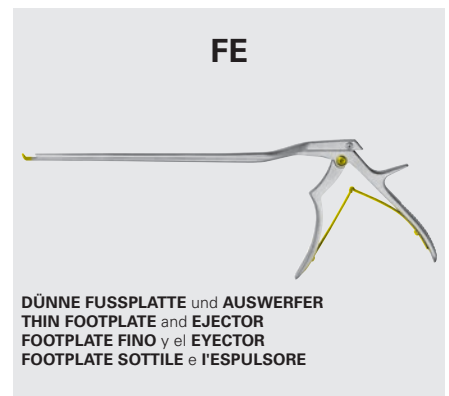
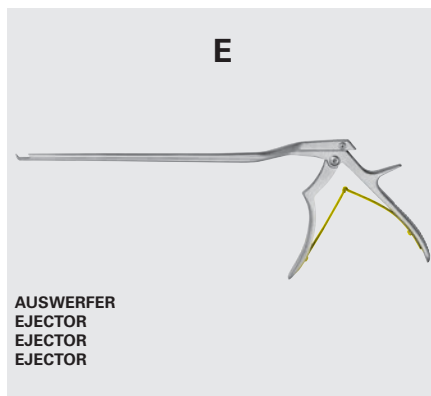
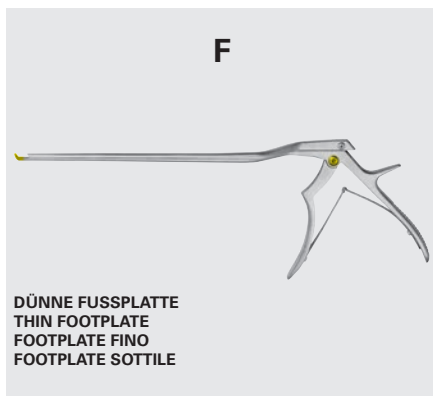

Für **AUSWERFER** fügen Sie ein "E" hinter die Artikelnummer (nicht möglich für 1 & 2 mm Stanzen)
 For **EJECTOR** please add "E" behind the item number (not available for 1 & 2 mm punches)
 Para el **EJECTOR** agregue por favor "E" detrás del número del artículo (no disponible para los sacadores de 1 y 2 mm)
 Per **EJECTOR** aggiunga prego la "E" dietro il numero dell'articolo (non disponibile per i punzoni da 1 & 2 mm)



Für **DÜNNE FUSSPLATTE** fügen Sie ein "F" hinter die Artikelnummer
 For **THIN FOOTPLATE** please add "F" behind the item number
 Para el **FOOTPLATE FINO** agregue por favor "F" detrás del número del artículo
 Per **FOOTPLATE SOTTILE** aggiunga prego la "F" dietro il numero dell'articolo



Für **DÜNNE FUSSPLATTE und AUSWERFER** (nicht möglich für 1 & 2 mm Stanzen) fügen Sie ein "FE" hinter die Artikelnummer
 For **THIN FOOTPLATE and EJECTOR** (not available for 1 & 2 mm punches) please add "FE" behind the item number
 Para **FOOTPLATE FINO y el EJECTOR** (no disponible para los sacadores de 1 y 2 mm) agregue por favor "FE" detrás del número del artículo
 Per **FOOTPLATE SOTTILE e l'ESPULSORE** (non disponibile per i punzoni da 1 & 2 mm) aggiunga prego la "FE" dietro il numero dell'articolo

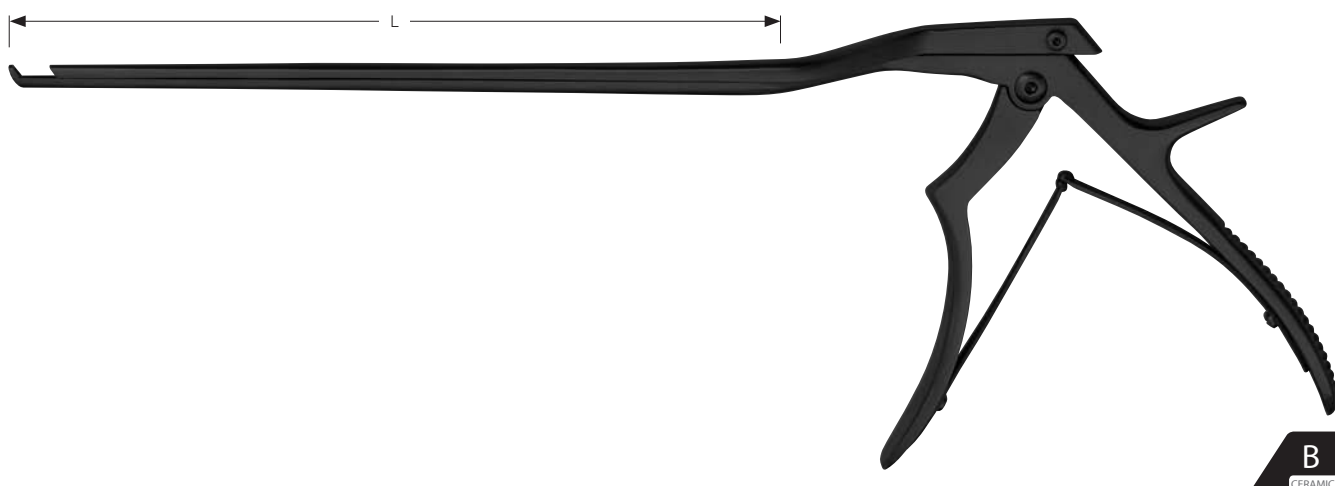

BAYONET-KERRISON

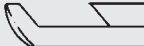
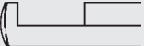
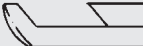
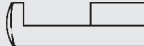
	L	links left izquierda sinistra		rechts right derecha destra	
					
Bissbreite Width of bite Ancura de la boca Larghezza del morso	Schaftlänge Length of shaft Longitud del vástago Lunghezza dell'asta	40° nach oben 40° upwards 40° hacia arriba 40° verso l'alto	90° nach oben 90° upwards 90° hacia arriba 90° verso l'alto	40° nach oben 40° upwards 40° hacia arriba 40° verso l'alto	90° nach oben 90° upwards 90° hacia arriba 90° verso l'alto
1,0 mm	110 mm, 4 3/8"	40-022-01 B	40-023-01 B	40-022-31 B	40-023-31 B
2,0 mm	110 mm, 4 3/8"	40-022-02 B	40-023-02 B	40-022-32 B	40-023-32 B
3,0 mm	110 mm, 4 3/8"	40-022-03 B	40-023-03 B	40-022-33 B	40-023-33 B
4,0 mm	110 mm, 4 3/8"	40-022-04 B	40-023-04 B	40-022-34 B	40-023-34 B
5,0 mm	110 mm, 4 3/8"	40-022-05 B	40-023-05 B	40-022-35 B	40-023-35 B
6,0 mm	110 mm, 4 3/8"	40-022-06 B	40-023-06 B	40-022-36 B	40-023-36 B
1,0 mm	150 mm, 6"	40-022-11 B	40-023-11 B	40-022-41 B	40-023-41 B
2,0 mm	150 mm, 6"	40-022-12 B	40-023-12 B	40-022-42 B	40-023-42 B
3,0 mm	150 mm, 6"	40-022-13 B	40-023-13 B	40-022-43 B	40-023-43 B
4,0 mm	150 mm, 6"	40-022-14 B	40-023-14 B	40-022-44 B	40-023-44 B
5,0 mm	150 mm, 6"	40-022-15 B	40-023-15 B	40-022-45 B	40-023-45 B
6,0 mm	150 mm, 6"	40-022-16 B	40-023-16 B	40-022-46 B	40-023-46 B
1,0 mm	180 mm, 7"	40-022-21 B	40-023-21 B	40-022-51 B	40-023-51 B
2,0 mm	180 mm, 7"	40-022-22 B	40-023-22 B	40-022-52 B	40-023-52 B
3,0 mm	180 mm, 7"	40-022-23 B	40-023-23 B	40-022-53 B	40-023-53 B
4,0 mm	180 mm, 7"	40-022-24 B	40-023-24 B	40-022-54 B	40-023-54 B
5,0 mm	180 mm, 7"	40-022-25 B	40-023-25 B	40-022-55 B	40-023-55 B
6,0 mm	180 mm, 7"	40-022-26 B	40-023-26 B	40-022-56 B	40-023-56 B

Weitere Längen auf Anfrage
Other lengths on request
Otras longitudes bajo pedido
Ulteriori lunghezze su richiesta

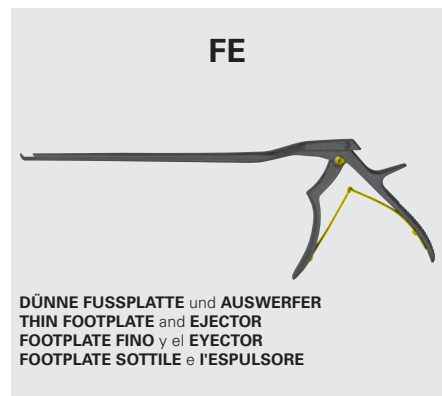
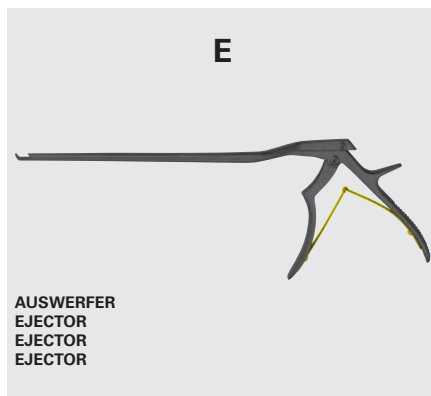
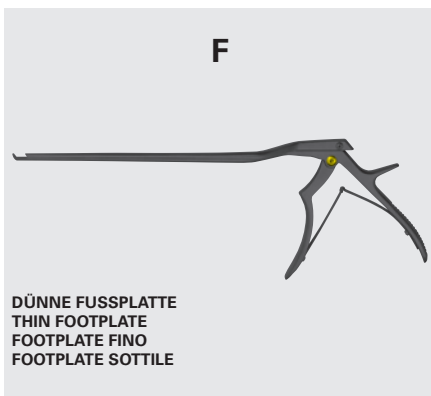

Für **AUSWERFER** fügen Sie ein "E" hinter die Artikelnummer (nicht möglich für 1 & 2 mm Stanzen)
 For **EJECTOR** please add "E" behind the item number (not available for 1 & 2 mm punches)
 Para el **EJECTOR** agregue por favor "E" detrás del número del artículo (no disponible para los sacadores de 1 y 2 mm)
 Per **EJECTOR** aggiunga prego la "E" dietro il numero dell'articolo (non disponibile per i punzoni da 1 & 2 mm)



Für **DÜNNE FUSSPLATTE** fügen Sie ein "F" hinter die Artikelnummer
 For **THIN FOOTPLATE** please add "F" behind the item number
 Para el **FOOTPLATE FINO** agregue por favor "F" detrás del número del artículo
 Per **FOOTPLATE SOTTILE** aggiunga prego la "F" dietro il numero dell'articolo



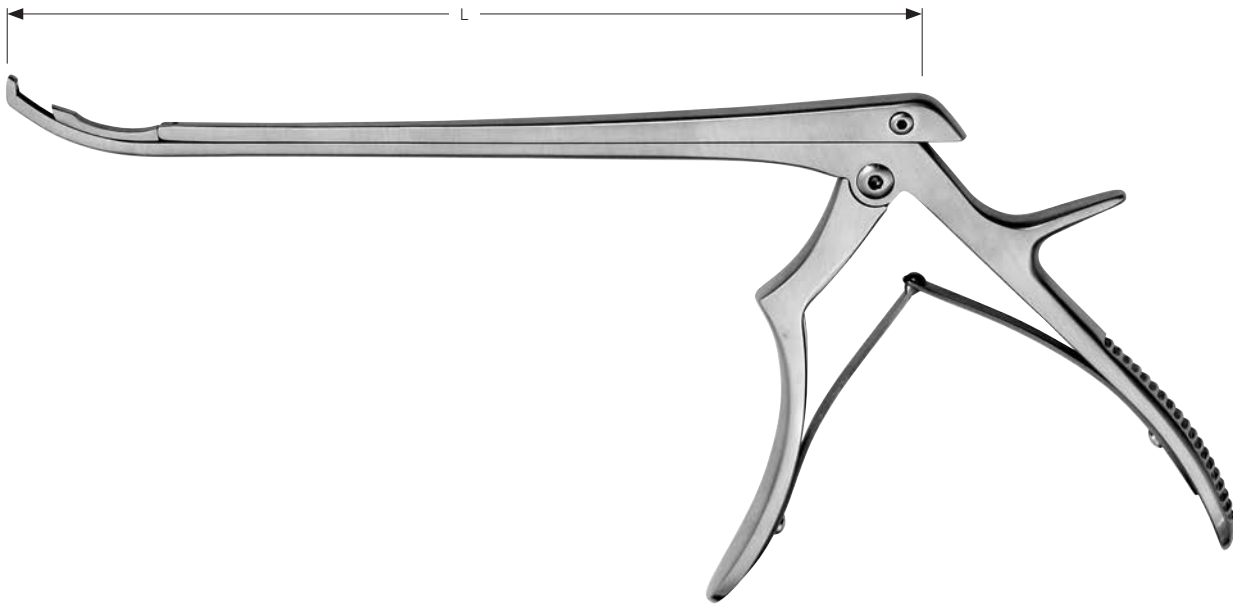

Für **DÜNNE FUSSPLATTE und AUSWERFER** (nicht möglich für 1 & 2 mm Stanzen) fügen Sie ein "FE" hinter die Artikelnummer
 For **THIN FOOTPLATE and EJECTOR** (not available for 1 & 2 mm punches) please add "FE" behind the item number
 Para **FOOTPLATE FINO y el EJECTOR** (no disponible para los sacadores de 1 y 2 mm) agregue por favor "FE" detrás del número del artículo
 Per **FOOTPLATE SOTTILE e l'ESPULSORE** (non disponibile per i punzoni da 1 & 2 mm) aggiunga prego la "FE" dietro il numero dell'articolo



STEEL
STAINLESS

KERRISON

Bissbreite Width of bite Ancura de la boca Larghezza del morso	L Schaftlänge Length of shaft Longitud del vástago Lunghezza dell'asta	 40° nach oben 40° upwards 40° hacia arriba 40° verso l'alto	 40° nach unten 40° downwards 40° hacia abajo 40° verso il basso
2,0 mm	180 mm, 7 "	40-024-02	40-025-02
3,0 mm	180 mm, 7 "	40-024-03	40-025-03
4,0 mm	180 mm, 7 "	40-024-04	40-025-04
5,0 mm	180 mm, 7 "	40-024-05	
2,0 mm	200 mm, 8 "	40-024-12	40-025-12
3,0 mm	200 mm, 8 "	40-024-13	40-025-13
4,0 mm	200 mm, 8 "	40-024-14	40-025-14
5,0 mm	200 mm, 8 "	40-024-15	

Weitere Längen auf Anfrage
Other lengths on request
Otras longitudes bajo pedido
Ulteriori lunghezze su richiesta

STEEL
STAINLESS



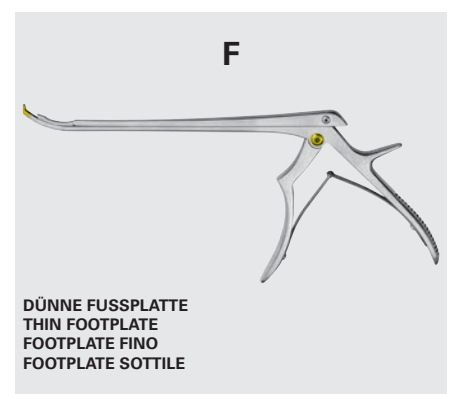

Für **DÜNNE FUSSPLATTE** fügen Sie ein "F" hinter die Artikelnummer
For **THIN FOOTPLATE** please add "F" behind the item number
Para el **FOOTPLATE FINO** agregue por favor "F" detrás del número del artículo
Per **FOOTPLATE SOTTILE** aggiunga prego la "F" dietro il numero dell'articolo





KERRISON

	L		
Bissbreite Width of bite Ancura de la boca Larghezza del morso	Schaftlänge Length of shaft Longitud del vástago Lunghezza dell'asta	40° nach oben 40° upwards 40° hacia arriba 40° verso l'alto	40° nach unten 40° downwards 40° hacia abajo 40° verso il basso
2,0 mm	180 mm, 7 "	40-024-02 B	40-025-02 B
3,0 mm	180 mm, 7 "	40-024-03 B	40-025-03 B
4,0 mm	180 mm, 7 "	40-024-04 B	40-025-04 B
5,0 mm	180 mm, 7 "	40-024-05 B	
2,0 mm	200 mm, 8 "	40-024-12 B	40-025-12 B
3,0 mm	200 mm, 8 "	40-024-13 B	40-025-13 B
4,0 mm	200 mm, 8 "	40-024-14 B	40-025-14 B
5,0 mm	200 mm, 8 "	40-024-15 B	

Weitere Längen auf Anfrage
Other lengths on request
Otras longitudes bajo pedido
Ulteriori lunghezze su richiesta



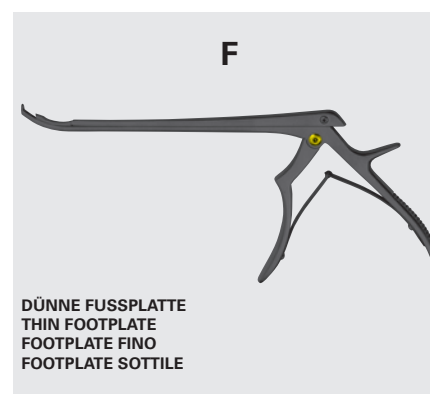

Für **DÜNNE FUSSPLATTE** fügen Sie ein "F" hinter die Artikelnummer
For **THIN FOOTPLATE** please add "F" behind the item number
Para el **FOOTPLATE FINO** agregue por favor "F" detrás del número del artículo
Per **FOOTPLATE SOTTILE** aggiunga prego la "F" dietro il numero dell'articolo

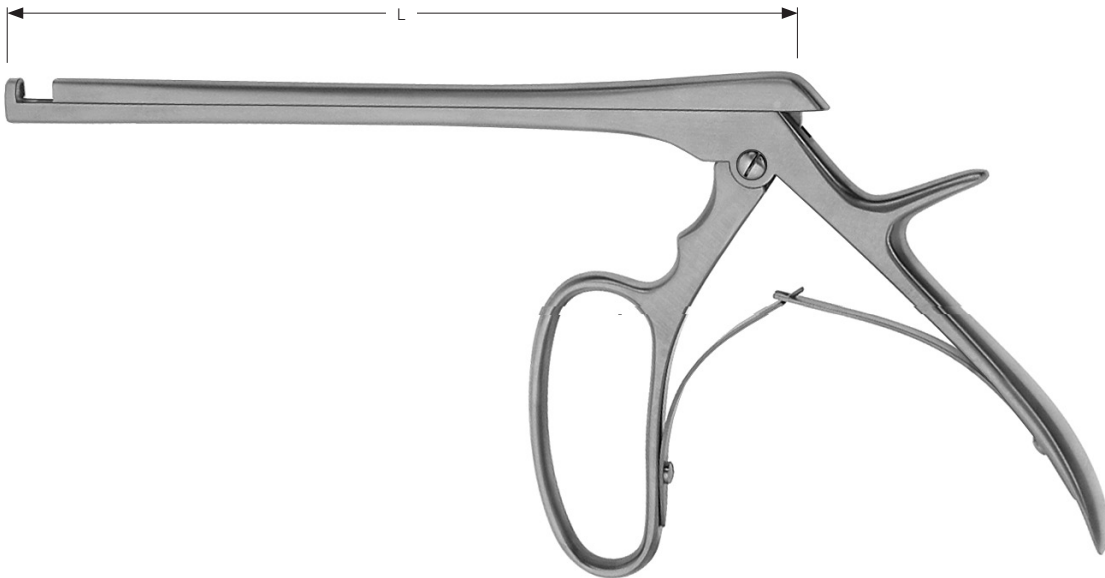

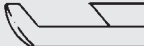
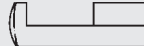

STEEL
STAINLESS

FERRIS-SMITH-KERRISON

	L			
Bissbreite Width of bite Ancura de la boca Larghezza del morso	Schaftlänge Length of shaft Longitud del vástago Lunghezza dell'asta	40° nach oben 40° upwards 40° hacia arriba 40° verso l'alto	90° nach oben 90° upwards 90° hacia arriba 90° verso l'alto	90° nach unten 90° downwards 90° hacia abajo 90° il basso
3,0 mm	180 mm, 7"	40-027-23	40-027-03	40-027-13
5,0 mm	180 mm, 7"	40-027-25	40-027-05	40-027-15

Weitere Längen auf Anfrage
Other lengths on request
Otras longitudes bajo pedido
Ulteriori lunghezze su richiesta

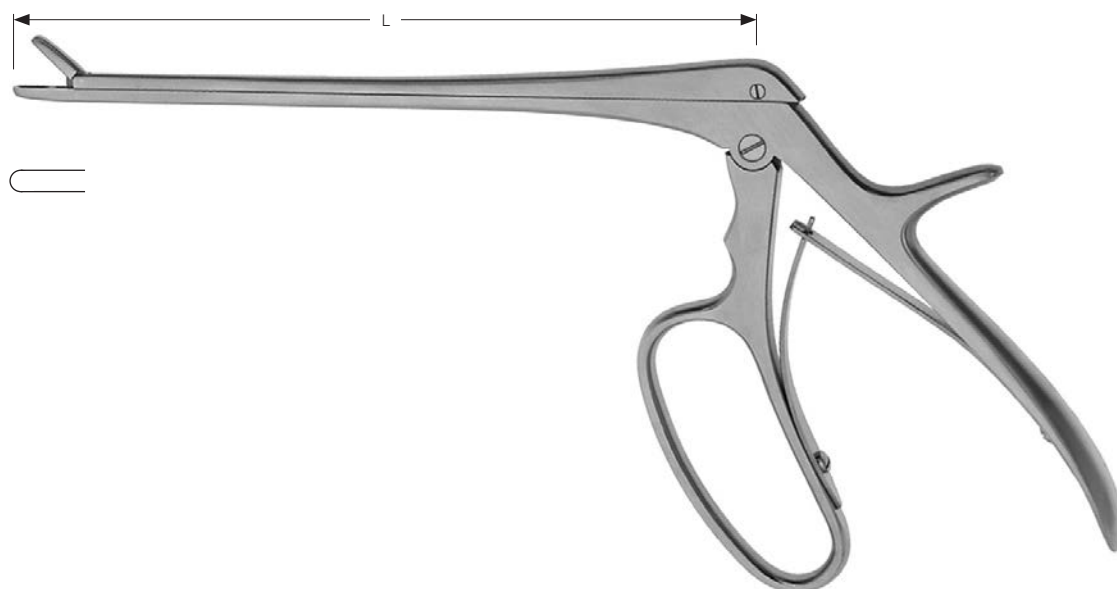

FERRIS-SMITH-CUSHING

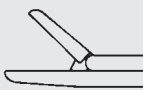
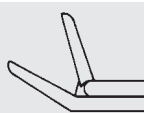
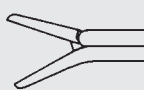
	L			
Bissbreite Width of bite Ancura de la boca Larghezza del morso	Schaftlänge Length of shaft Longitud del vástago Lunghezza dell'asta	gerade straight recta retta	aufgebogen 30° curved up 30° curva hacia arriba 30° curva verso l'alto 30°	abwärts gebogen 30° curved down 30° curva hacia abajo 30° curva verso il basso 30°
2,0 x 10,0 mm	180 mm, 7 "	40-028-02	40-028-12	40-028-22
3,0 x 10,0 mm	180 mm, 7 "	40-028-03	40-028-13	40-028-23
4,0 x 10,0 mm	180 mm, 7 "	40-028-04	40-028-14	40-028-24
5,0 x 10,0 mm	180 mm, 7 "	40-028-05	40-028-15	40-028-25
6,0 x 10,0 mm	180 mm, 7 "	40-028-06	40-028-16	40-028-26

Weitere Längen auf Anfrage
 Other lengths on request
 Otras longitudes bajo pedido
 Ulteriori lunghezze su richiesta

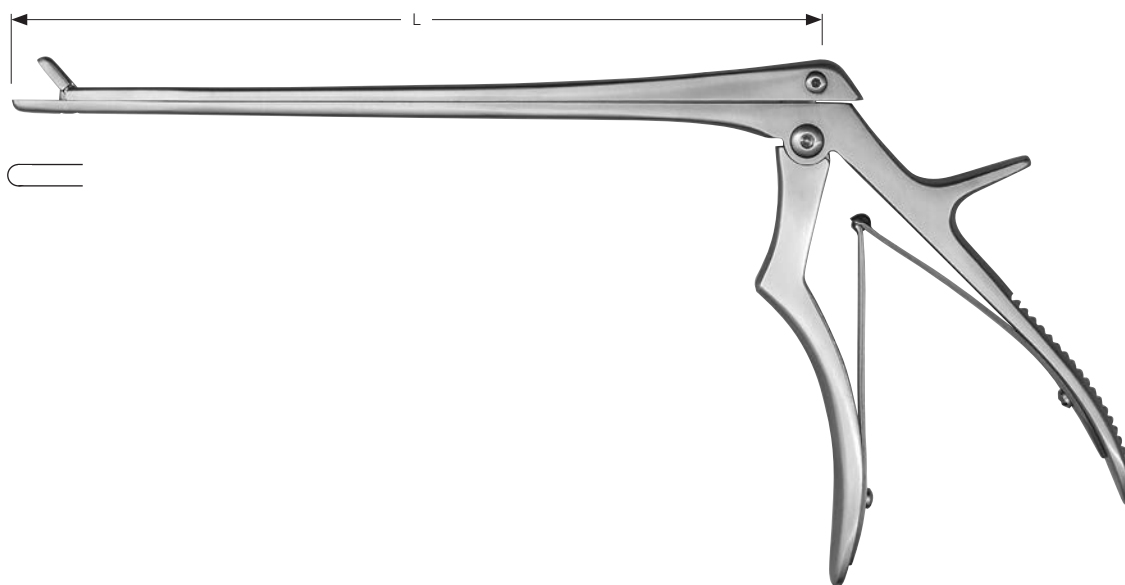

FERRIS-SMITH-CUSHING

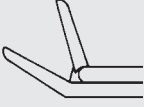
	L		
Bissbreite Width of bite Ancura de la boca Larghezza del morso	Schaftlänge Length of shaft Longitud del vástago Lunghezza dell'asta	gerade straight recta retta	aufgebogen 30° curved up 30° curva hacia arriba 30° curva verso l'alto 30°
2,0 x 10,0 mm	180 mm, 7 "	40-028-32	40-028-42
3,0 x 10,0 mm	180 mm, 7 "	40-028-33	40-028-43
4,0 x 10,0 mm	180 mm, 7 "	40-028-34	40-028-44
5,0 x 10,0 mm	180 mm, 7 "	40-028-35	40-028-45
6,0 x 10,0 mm	180 mm, 7 "	40-028-36	40-028-46
2,0 x 10,0 mm	200 mm, 8 "	40-028-52	40-028-62
3,0 x 10,0 mm	200 mm, 8 "	40-028-53	40-028-63
4,0 x 10,0 mm	200 mm, 8 "	40-028-54	40-028-64
5,0 x 10,0 mm	200 mm, 8 "	40-028-55	40-028-65
6,0 x 10,0 mm	200 mm, 8 "	40-028-56	40-028-66
2,0 x 10,0 mm	230 mm, 9 "	40-028-72	40-028-82
3,0 x 10,0 mm	230 mm, 9 "	40-028-73	40-028-83
4,0 x 10,0 mm	230 mm, 9 "	40-028-74	40-028-84
5,0 x 10,0 mm	230 mm, 9 "	40-028-75	40-028-85
6,0 x 10,0 mm	230 mm, 9 "	40-028-76	40-028-86

Weitere Längen auf Anfrage
Other lengths on request
Otras longitudes bajo pedido
Ulteriori lunghezze su richiesta



STEEL
STAINLESS

FERRIS-SMITH-CUSHING

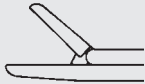
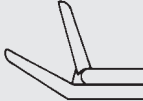
	L		
Bissbreite Width of bite Ancura de la boca Larghezza del morso	Schaftlänge Length of shaft Longitud del vástago Lunghezza dell'asta	gerade straight recta retta	aufgebogen 30° curved up 30° curva hacia arriba 30° curva verso l'alto 30°
2,0 x 10,0 mm	180 mm, 7 "	40-028-32 Z	40-028-42 Z
3,0 x 10,0 mm	180 mm, 7 "	40-028-33 Z	40-028-43 Z
4,0 x 10,0 mm	180 mm, 7 "	40-028-34 Z	40-028-44 Z
5,0 x 10,0 mm	180 mm, 7 "	40-028-35 Z	40-028-45 Z
6,0 x 10,0 mm	180 mm, 7 "	40-028-36 Z	40-028-46 Z
2,0 x 10,0 mm	200 mm, 8 "	40-028-52 Z	40-028-62 Z
3,0 x 10,0 mm	200 mm, 8 "	40-028-53 Z	40-028-63 Z
4,0 x 10,0 mm	200 mm, 8 "	40-028-54 Z	40-028-64 Z
5,0 x 10,0 mm	200 mm, 8 "	40-028-55 Z	40-028-65 Z
6,0 x 10,0 mm	200 mm, 8 "	40-028-56 Z	40-028-66 Z
2,0 x 10,0 mm	230 mm, 9 "	40-028-72 Z	40-028-82 Z
3,0 x 10,0 mm	230 mm, 9 "	40-028-73 Z	40-028-83 Z
4,0 x 10,0 mm	230 mm, 9 "	40-028-74 Z	40-028-84 Z
5,0 x 10,0 mm	230 mm, 9 "	40-028-75 Z	40-028-85 Z
6,0 x 10,0 mm	230 mm, 9 "	40-028-76 Z	40-028-86 Z

Weitere Längen auf Anfrage
 Other lengths on request
 Otras longitudes bajo pedido
 Ulteriori lunghezze su richiesta

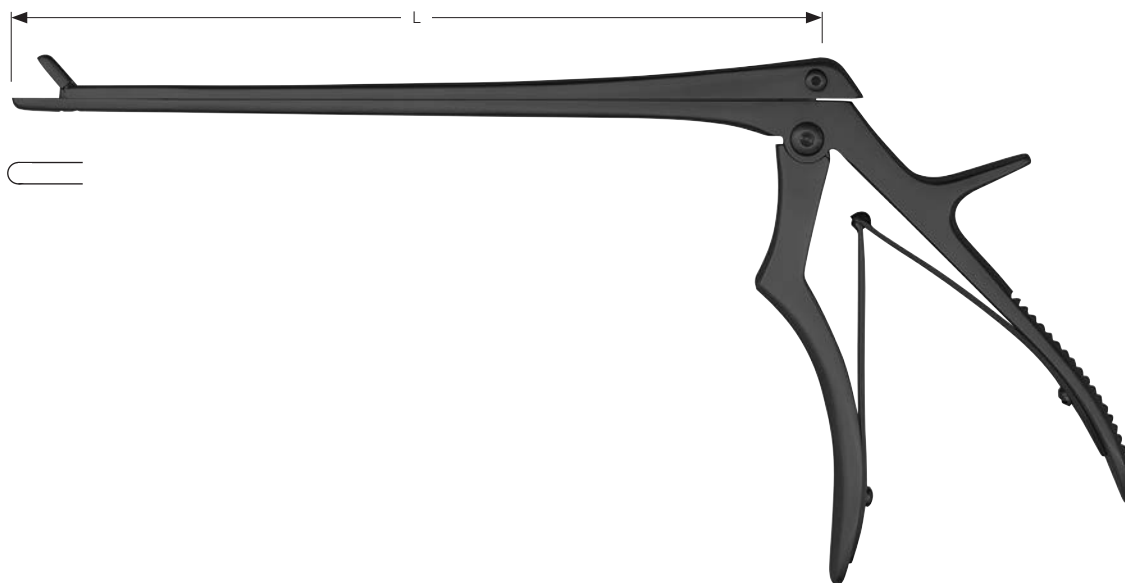

FERRIS-SMITH-CUSHING

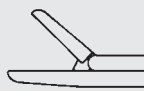
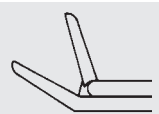
	L		
Bissbreite Width of bite Ancura de la boca Larghezza del morso	Schaftlänge Length of shaft Longitud del vástago Lunghezza dell'asta	gerade straight recta retta	aufgebogen 30° curved up 30° curva hacia arriba 30° curva verso l'alto 30°
2,0 x 10,0 mm	180 mm, 7 "	40-028-32 B	40-028-42 B
3,0 x 10,0 mm	180 mm, 7 "	40-028-33 B	40-028-43 B
4,0 x 10,0 mm	180 mm, 7 "	40-028-34 B	40-028-44 B
5,0 x 10,0 mm	180 mm, 7 "	40-028-35 B	40-028-45 B
6,0 x 10,0 mm	180 mm, 7 "	40-028-36 B	40-028-46 B
2,0 x 10,0 mm	200 mm, 8 "	40-028-52 B	40-028-62 B
3,0 x 10,0 mm	200 mm, 8 "	40-028-53 B	40-028-63 B
4,0 x 10,0 mm	200 mm, 8 "	40-028-54 B	40-028-64 B
5,0 x 10,0 mm	200 mm, 8 "	40-028-55 B	40-028-65 B
6,0 x 10,0 mm	200 mm, 8 "	40-028-56 B	40-028-66 B
2,0 x 10,0 mm	230 mm, 9 "	40-028-72 B	40-028-82 B
3,0 x 10,0 mm	230 mm, 9 "	40-028-73 B	40-028-83 B
4,0 x 10,0 mm	230 mm, 9 "	40-028-74 B	40-028-84 B
5,0 x 10,0 mm	230 mm, 9 "	40-028-75 B	40-028-85 B
6,0 x 10,0 mm	230 mm, 9 "	40-028-76 B	40-028-86 B

Weitere Längen auf Anfrage
Other lengths on request
Otras longitudes bajo pedido
Ulteriori lunghezze su richiesta

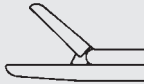
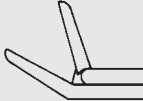

FERRIS-SMITH-CUSHING

	L		
Bissbreite Width of bite Ancura de la boca Larghezza del morso	Schaftlänge Length of shaft Longitud del vástago Lunghezza dell'asta	gerade straight recta retta	aufgebogen 30° curved up 30° curva hacia arriba 30° curva verso l'alto 30°
2,0 x 10,0 mm	180 mm, 7 "	40-028-32 ZB	40-028-42 ZB
3,0 x 10,0 mm	180 mm, 7 "	40-028-33 ZB	40-028-43 ZB
4,0 x 10,0 mm	180 mm, 7 "	40-028-34 ZB	40-028-44 ZB
5,0 x 10,0 mm	180 mm, 7 "	40-028-35 ZB	40-028-45 ZB
6,0 x 10,0 mm	180 mm, 7 "	40-028-36 ZB	40-028-46 ZB
2,0 x 10,0 mm	200 mm, 8 "	40-028-52 ZB	40-028-62 ZB
3,0 x 10,0 mm	200 mm, 8 "	40-028-53 ZB	40-028-63 ZB
4,0 x 10,0 mm	200 mm, 8 "	40-028-54 ZB	40-028-64 ZB
5,0 x 10,0 mm	200 mm, 8 "	40-028-55 ZB	40-028-65 ZB
6,0 x 10,0 mm	200 mm, 8 "	40-028-56 ZB	40-028-66 ZB
2,0 x 10,0 mm	230 mm, 9 "	40-028-72 ZB	40-028-82 ZB
3,0 x 10,0 mm	230 mm, 9 "	40-028-73 ZB	40-028-83 ZB
4,0 x 10,0 mm	230 mm, 9 "	40-028-74 ZB	40-028-84 ZB
5,0 x 10,0 mm	230 mm, 9 "	40-028-75 ZB	40-028-85 ZB
6,0 x 10,0 mm	230 mm, 9 "	40-028-76 ZB	40-028-86 ZB

Weitere Längen auf Anfrage
 Other lengths on request
 Otras longitudes bajo pedido
 Ulteriori lunghezze su richiesta



STEEL
STAINLESS

COLCLOUGH

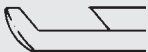
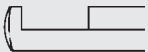
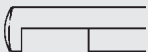
	L			
Bissbreite Width of bite Ancura de la boca Larghezza del morso	Schaftlänge Length of shaft Longitud del vástago Lunghezza dell'asta	40° nach oben 40° upwards 40° hacia arriba 40° verso l'alto	90° nach oben 90° upwards 90° hacia arriba 90° verso l'alto	90° nach unten 90° downwards 90° hacia abajo 90° il basso
3,0 mm	150 mm, 6 "	40-029-03	40-029-01	40-029-53
5,0 mm	150 mm, 6 "	40-029-05	40-029-02	40-029-55
2,0 mm	200 mm, 8 "	40-029-12	40-029-22	40-029-62
3,0 mm	200 mm, 8 "	40-029-13	40-029-23	40-029-63
4,0 mm	200 mm, 8 "	40-029-14	40-029-24	40-029-64
5,0 mm	200 mm, 8 "	40-029-15	40-029-25	40-029-65

Weitere Längen auf Anfrage
Other lengths on request
Otras longitudes bajo pedido
Ulteriori lunghezze su richiesta

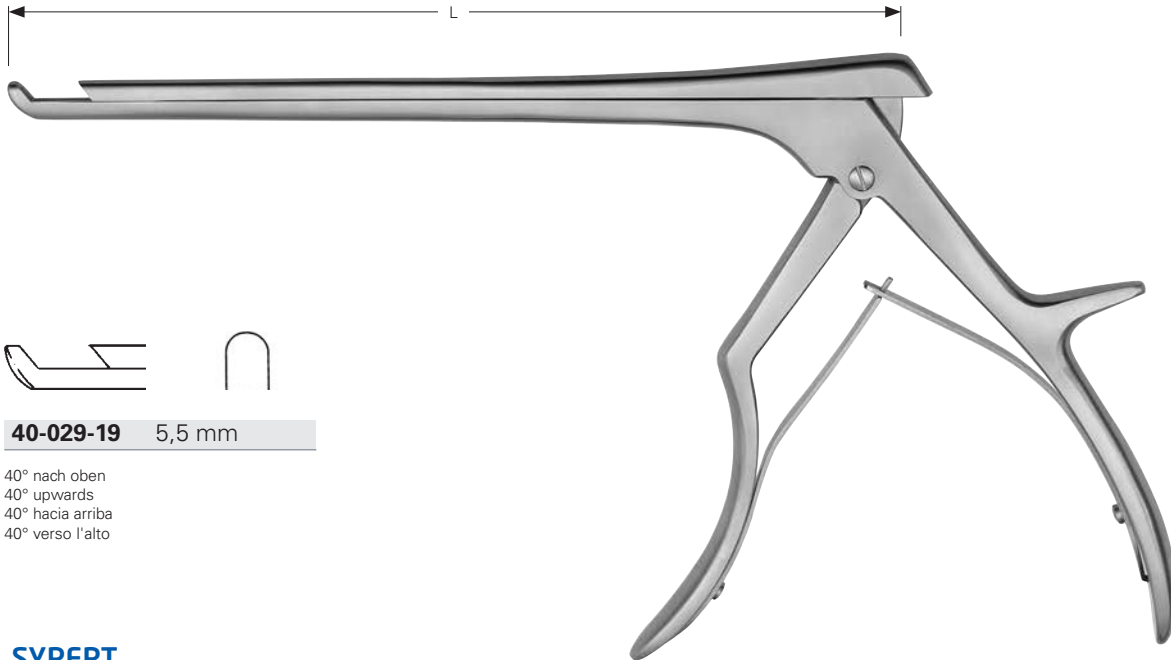

40-029-19 5,5 mm

40° nach oben
40° upwards
40° hacia arriba
40° verso l'alto

SYPERT

40-029-19 25,5 cm, 10 "

STEEL
STAINLESS

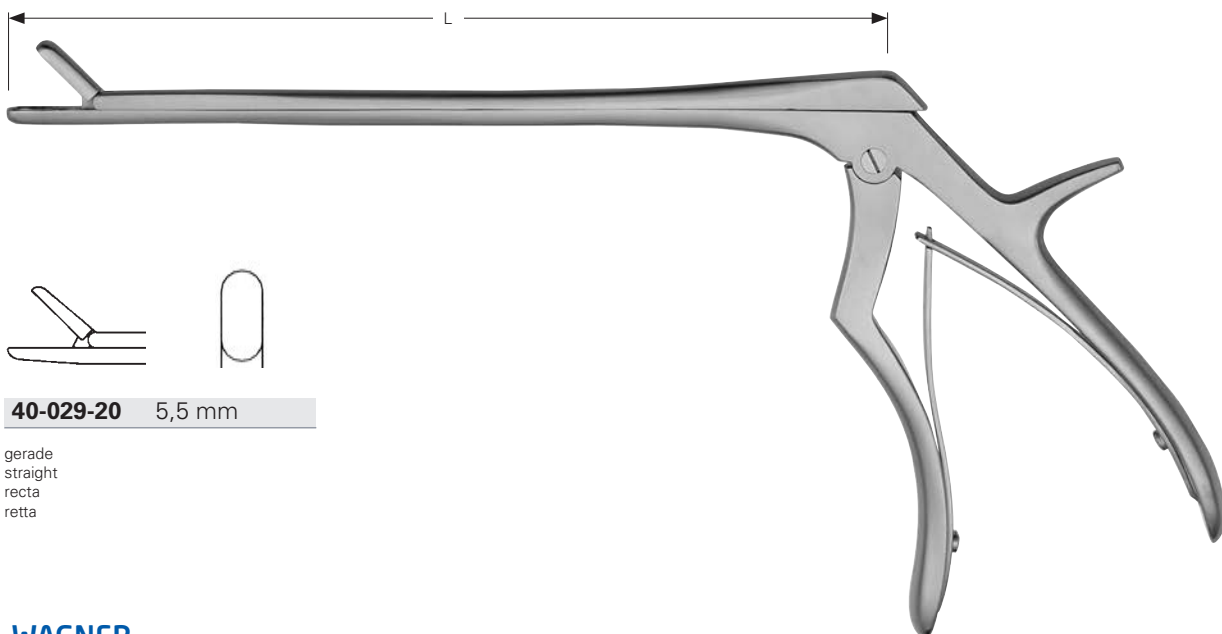

40-029-20 5,5 mm

gerade
straight
recta
retta

WAGNER

40-029-20 20,0 cm, 8 "

STEEL
STAINLESS

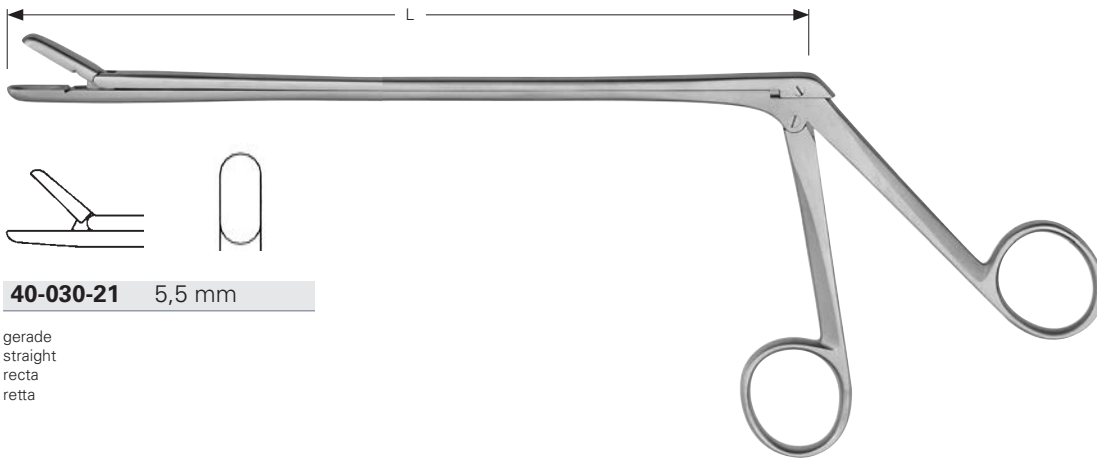

40-030-21 5,5 mm

gerade
 straight
 recta
 retta

STEEL
 STAINLESS

WAGNER

40-030-21 21,0 cm, 8 ¼ "

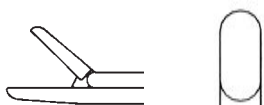
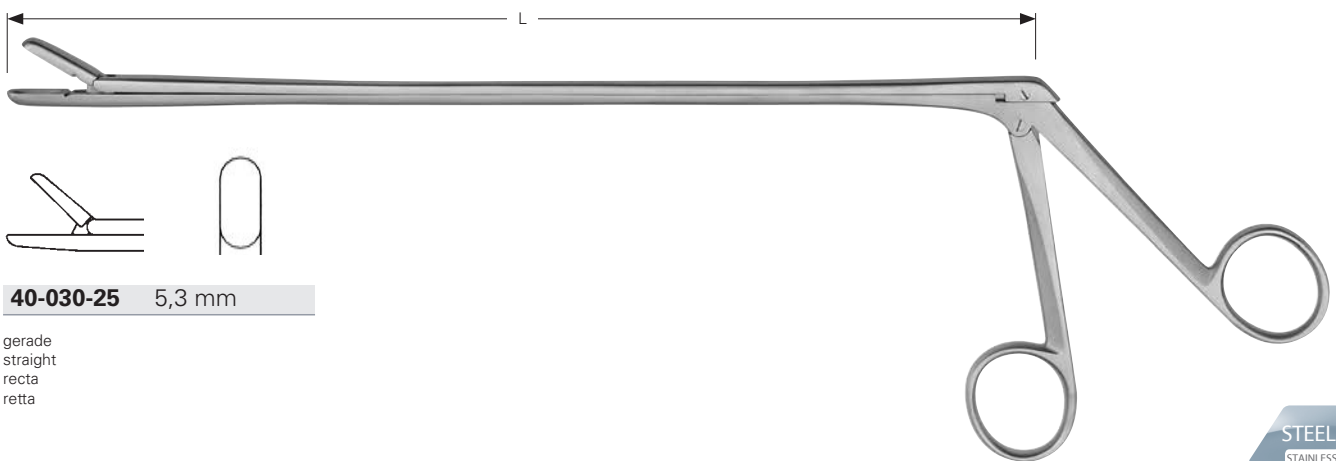

40-030-25 5,3 mm

gerade
 straight
 recta
 retta

STEEL
 STAINLESS

WAGNER

40-030-25 25,5 cm, 10 "

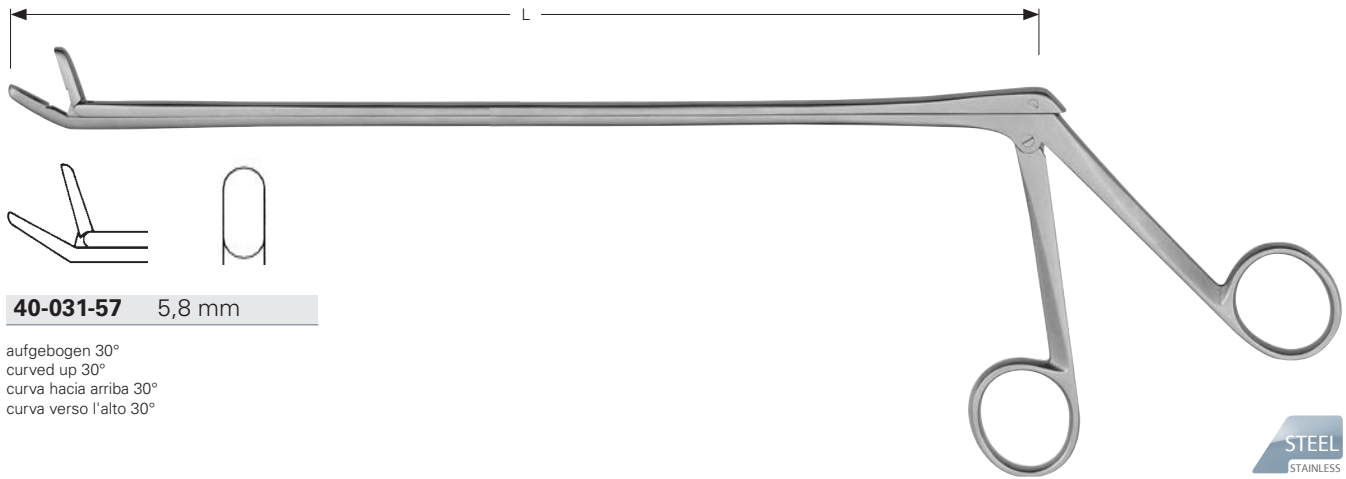

40-031-57 5,8 mm

aufgebogen 30°
 curved up 30°
 curva hacia arriba 30°
 curva verso l'alto 30°

SYPERT

40-031-57 25,5 cm, 10 "

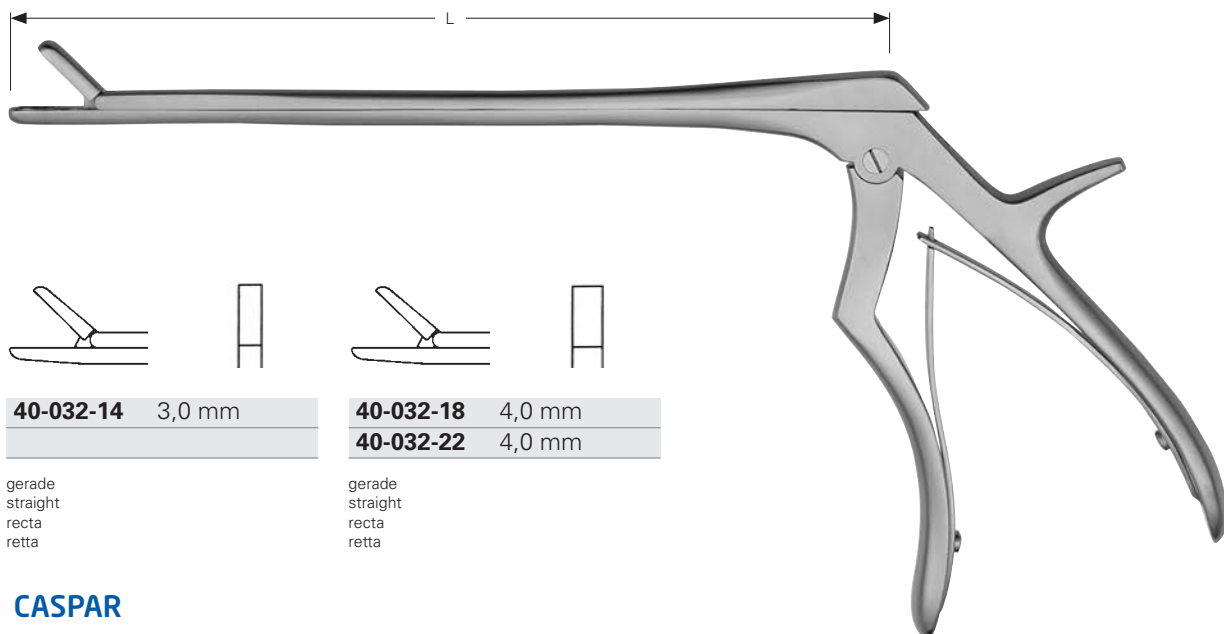

40-032-14 3,0 mm

gerade
 straight
 recta
 retta

40-032-18 4,0 mm

40-032-22 4,0 mm

gerade
 straight
 recta
 retta

CASPAR



40-032-14 - 40-032-18 18,0 cm, 7 "

40-032-22 22,0 cm, 8 3/4 "

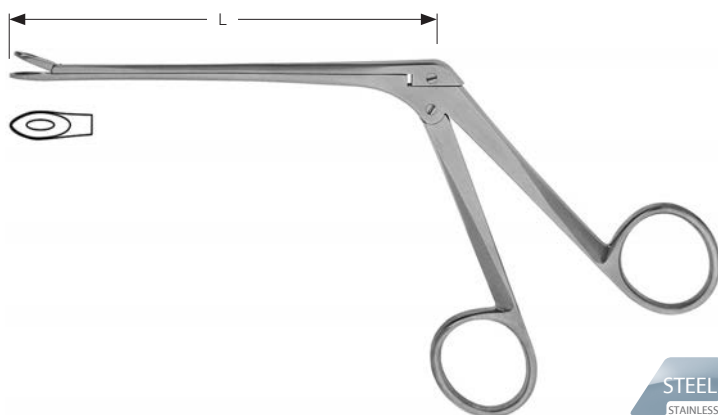



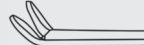

WEIL-BLAKESLEY

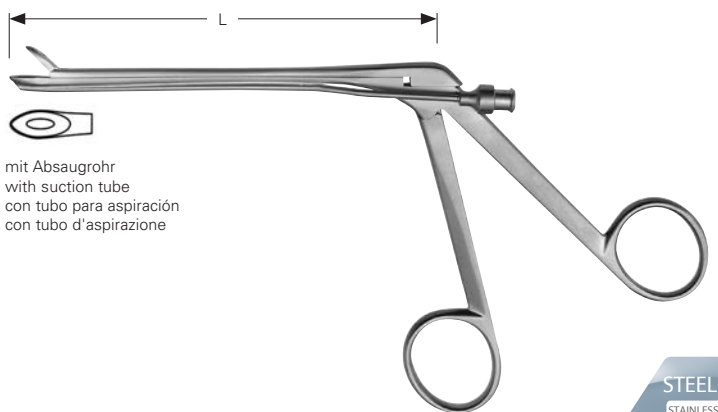
	L			
Bissbreite Width of bite Ancura de la boca Larghezza del morso	Schaftlänge Length of shaft Longitud del vástago Lunghezza dell'asta	gerade straight recta retta	aufgebogen 45° curved up 45° curva hacia arriba 45° curva verso l'alto 45°	aufgebogen 90° curved up 90° curva hacia arriba 90° curva verso l'alto 90°
3,0 mm	120 mm, 4 3/4"	40-036-30	40-037-30	40-038-30
3,6 mm	120 mm, 4 3/4"	40-036-36	40-037-36	40-038-36
4,2 mm	120 mm, 4 3/4"	40-036-42	40-037-42	40-038-42
4,8 mm	120 mm, 4 3/4"	40-036-48	40-037-48	40-038-48
5,2 mm	120 mm, 4 3/4"	40-036-58	40-037-58	40-038-58



mit Absaugrohr
with suction tube
con tubo para aspiración
con tubo d'aspirazione

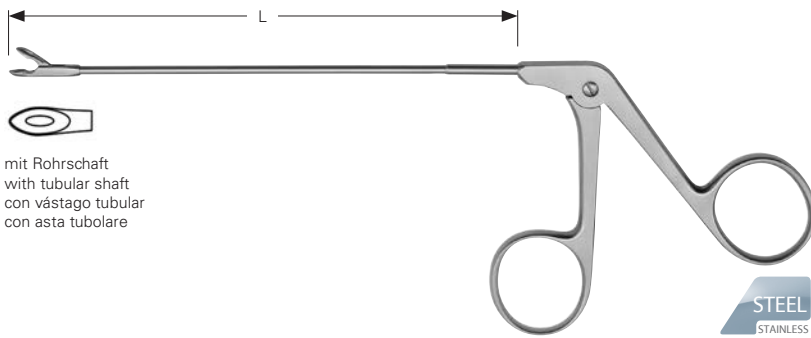

WEIL-BLAKESLEY

	L			
Bissbreite Width of bite Ancura de la boca Larghezza del morso	Schaftlänge Length of shaft Longitud del vástago Lunghezza dell'asta	gerade straight recta retta	aufgebogen 45° curved up 45° curva hacia arriba 45° curva verso l'alto 45°	aufgebogen 90° curved up 90° curva hacia arriba 90° curva verso l'alto 90°
2,5 mm	120 mm, 4 3/4"	40-036-30 A	40-037-30 A	
3,6 mm	120 mm, 4 3/4"	40-036-36 A	40-037-36 A	40-038-36 A
4,8 mm	120 mm, 4 3/4"	40-036-48 A	40-037-48 A	

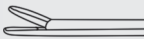

mit Rohrschaft
 with tubular shaft
 con vástago tubular
 con asta tubolare

WEIL-BLAKESLEY

	L			
Bissbreite Width of bite Ancura de la boca Larghezza del morso	Schaftlänge Length of shaft Longitud del vástago Lunghezza dell'asta	gerade straight recta retta	aufgebogen 45° curved up 45° curva hacia arriba 45° curva verso l'alto 45°	aufgebogen 90° curved up 90° curva hacia arriba 90° curva verso l'alto 90°
3,0 mm	130 mm, 5 "	40-036-30 R	40-037-30 R	
3,6 mm	130 mm, 5 "	40-036-36 R	40-037-36 R	40-038-36 R
4,2 mm	130 mm, 5 "	40-036-42 R	40-037-42 R	40-038-42 R
4,8 mm	130 mm, 5 "	40-036-48 R	40-037-48 R	40-038-48 R
3,0 mm	170 mm, 6 3/4 "	40-036-30 RL	40-037-30 RL	
3,6 mm	170 mm, 6 3/4 "	40-036-36 RL	40-037-36 RL	

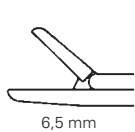

6,5 mm
40-036-65

gerade
 straight
 recta
 retta

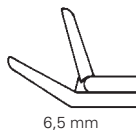

6,5 mm
40-037-65

aufgebogen 40°
 curved up 40°
 curva hacia arriba 40°
 curva verso l'alto 40°

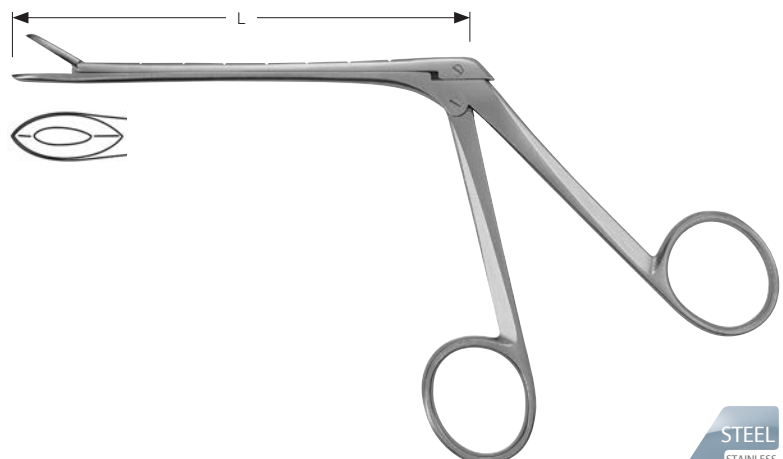

TILLEY-HENCKEL

40-036-65 - 40-037-65 10,0 cm, 4 "





40-038-00 1,0 mm
40-038-01 1,5 mm

gerade, durchschneidend
straight, through cutting
recta, cortantes
retta, taglienti

STRUYKEN

40-038-00 - 40-038-01 12,0 cm, 4 3/4"

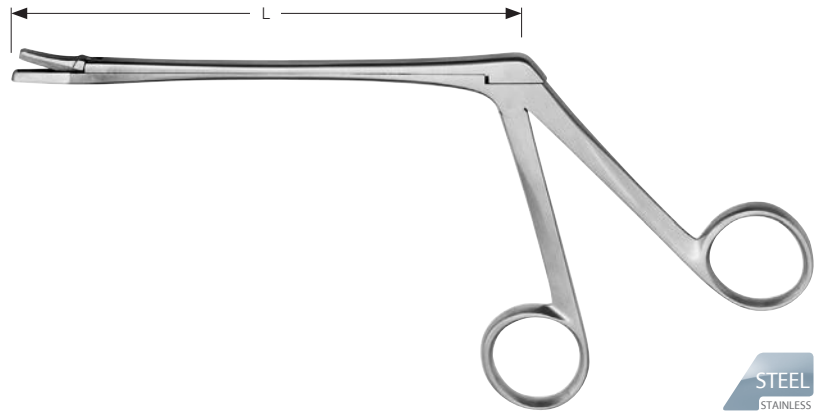

STEEL
STAINLESS

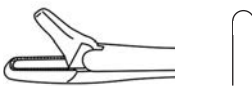

40-038-02 2,0 mm
40-038-03 3,0 mm
40-038-04 4,0 mm

gerade, durchschneidend
straight, through cutting
recta, cortantes
retta, taglienti

MYLES

40-038-02 - 40-038-04 12,0 cm, 4 3/4"



STEEL
STAINLESS



40-038-11 3,0 mm

aufgebogen 60°, durchschneidend
curved up 60°, through cutting
curva hacia arriba 60°, cortantes
curva verso l'alto 60°, taglienti

FRY

40-038-11 11,5 cm, 4 1/2"

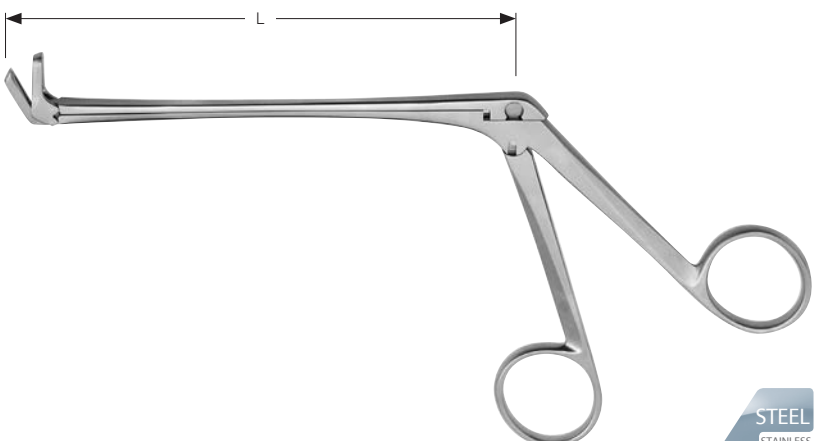

STEEL
STAINLESS

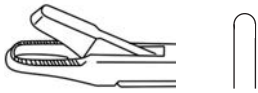

40-038-12 2,5 mm

40-038-13 3,0 mm

gerade, durchschneidend
 straight, through cutting
 recta, cortantes
 retta, taglienti

GRUENWALD-HENKE

40-038-12 - 40-038-13 11,0 cm, 4 3/8 "

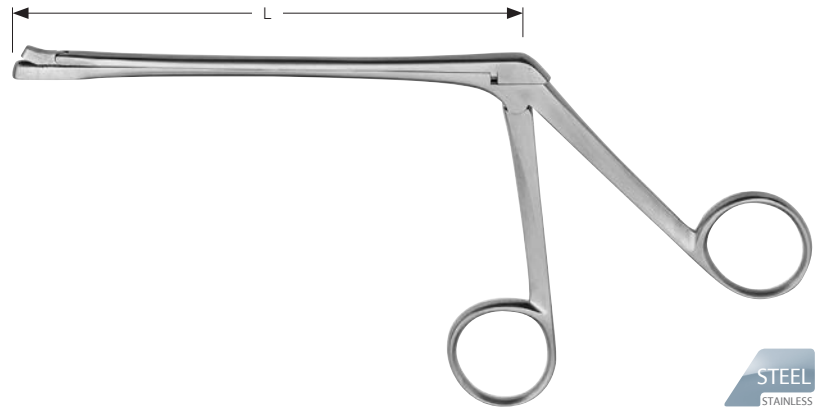

40-038-60 6,0 x 14,0 mm

aufgebogen 60°
 curved up 60°
 curva hacia arriba 60°
 curva verso l'alto 60°

BLAKESLEY-WIGAND

40-038-60 11,0 cm, 4 3/8 "

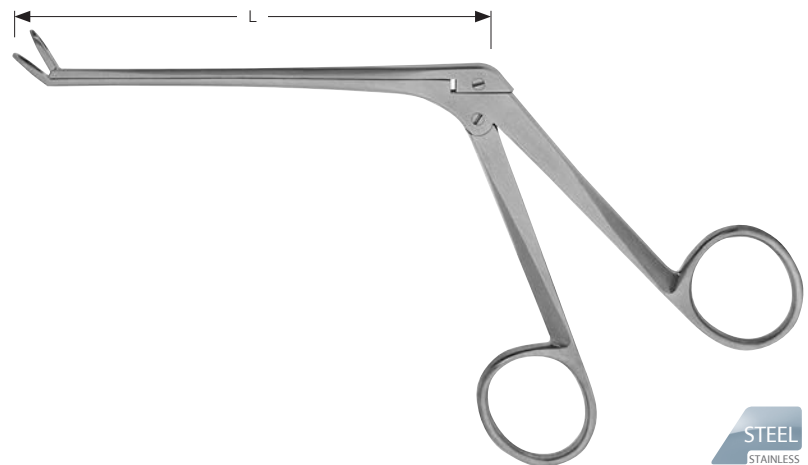

40-039-25 2,5 mm

aufgebogen 45°
 curved up 45°
 curva hacia arriba 45°
 curva verso l'alto 45°

HAJEK

40-039-25 12,0 cm, 4 3/4 "





40-040-05	5,0 mm
40-040-07	7,0 mm
40-040-09	9,0 mm
40-040-11	11,0 mm

gerade, durchschneidend
straight, through cutting
recta, cortantes
retta, taglienti

HARTMANN

40-040-05 - 40-040-11 12,0 cm, 4 3/4"



STEEL
STAINLESS

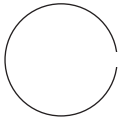

40-040-13	13,0 mm
40-040-15	15,0 mm
40-040-17	17,0 mm

gerade, durchschneidend
straight, through cutting
recta, cortantes
retta, taglienti

HARTMANN

40-040-13 - 40-040-17 12,0 cm, 4 3/4"

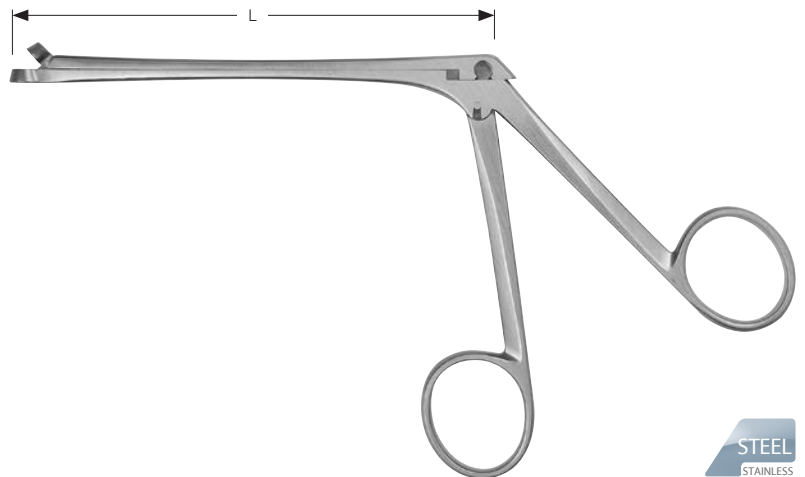

STEEL
STAINLESS



40-041-11	11,0 mm
40-041-12	12,0 mm
40-041-13	13,0 mm

gerade, durchschneidend
straight, through cutting
recta, cortantes
retta, taglienti

SCHMEDEN

40-041-11 - 40-041-13 12,0 cm, 4 3/4"



STEEL
STAINLESS



Ø 7,0 mm

40-042-01

gerade
 straight
 recta
 retta



40-042-02

gerade
 straight
 recta
 retta



40-042-03

gerade
 straight
 recta
 retta

WATSON-WILLIAMS

40-042-01 - 40-042-03 12,0 cm, 4 3/4 "

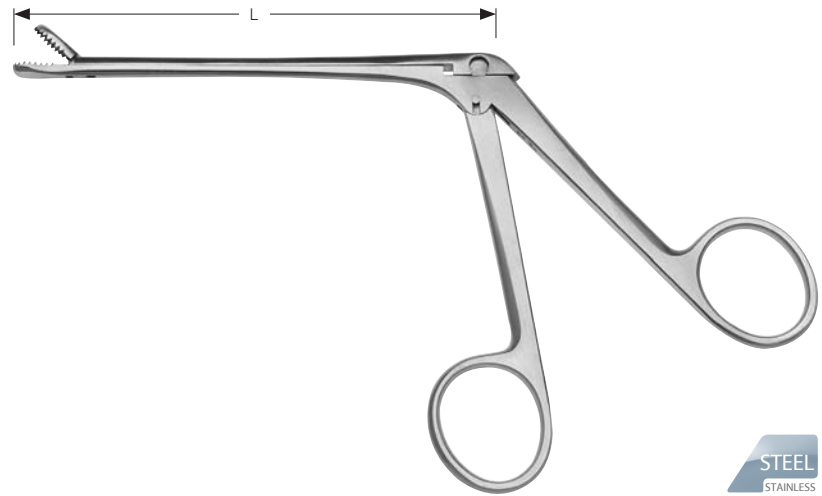

STEEL
 STAINLESS



40-042-04 5,0 mm

40-042-05 7,0 mm

40-042-06 9,0 mm

gerade
 straight
 recta
 retta

WATSON-WILLIAMS

40-042-04 - 40-042-06 12,0 cm, 4 3/4 "

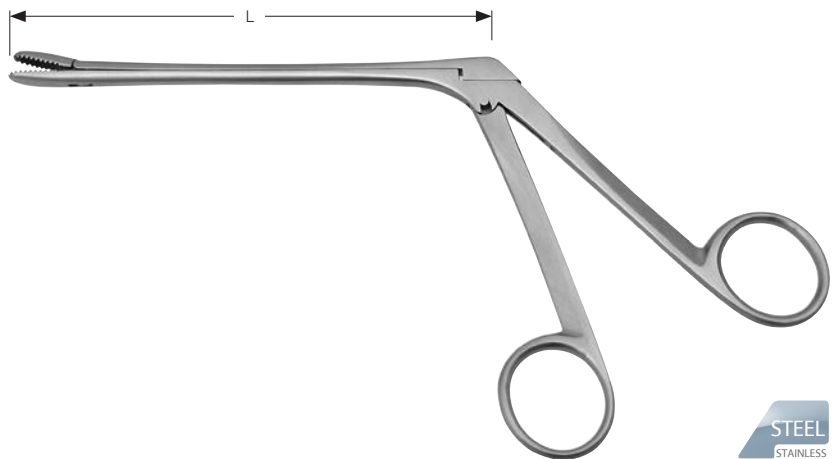

STEEL
 STAINLESS



3,5 mm

40-042-11



3,5 mm

40-042-12

aufgebogen 45°, durchschneidend
 curved up 45°, through cutting
 curva hacia arriba 45°, cortantes
 curva verso l'alto 45°, taglienti

WATSON-WILLIAMS

40-042-11 - 40-042-12 12,0 cm, 4 3/4 "

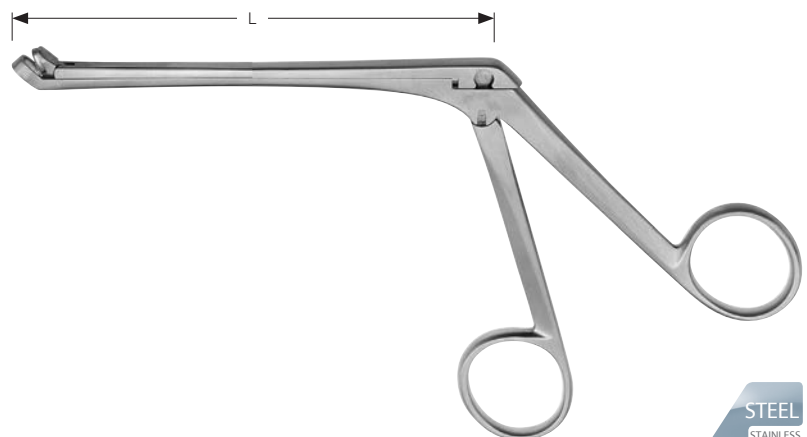

STEEL
 STAINLESS



40-043-01

aufgebogen 45°
curved up 45°
curva hacia arriba 45°
curva verso l'alto 45°

WATSON-WILLIAMS

40-043-01 12,0 cm, 4 3/4"

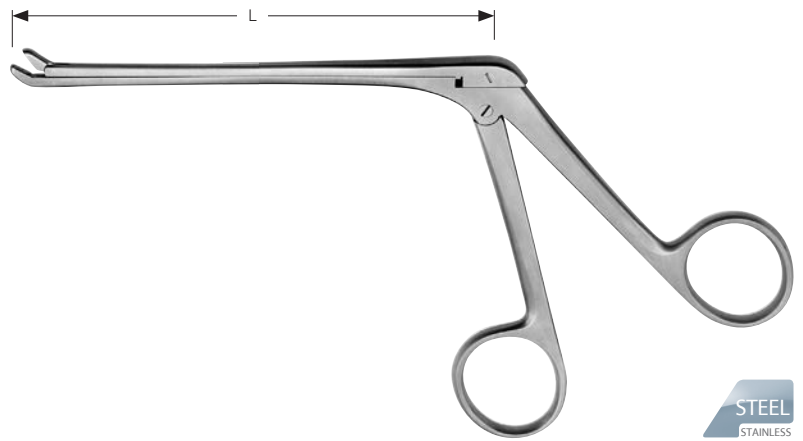

STEEL
STAINLESS



3,0 mm

40-044-03

gerade
straight
recta
retta



5,0 mm

40-044-05

gerade
straight
recta
retta



3,0 mm

40-045-03

aufgebogen 45°
curved up 45°
curva hacia arriba 45°
curva verso l'alto 45°



STEEL
STAINLESS

TAKAHASHI

40-044-03 - 40-045-03 12,0 cm, 4 3/4"



2,0 mm

40-046-00

gerade
straight
recta
retta

BECK

40-046-00 13,0 cm, 5 1/2"



STEEL
STAINLESS

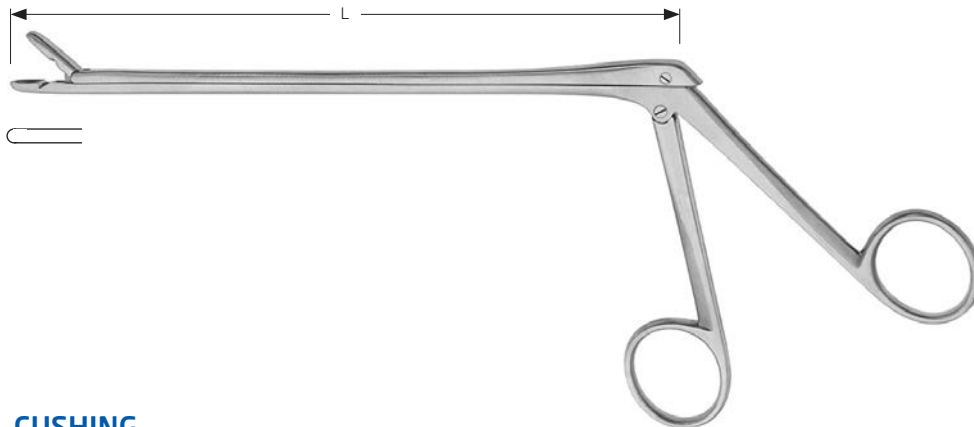

STEEL
STAINLESS

CUSHING

	L			
Bissbreite Width of bite Ancura de la boca Larghezza del morso	Schaftlänge Length of shaft Longitud del vástago Lunghezza dell'asta	gerade straight recta retta	aufgebogen 30° curved up 30° curva hacia arriba 30° curva verso l'alto 30°	abwärts gebogen 30° curved down 30° curva hacia abajo 30° curva verso il basso 30°
2,0 x 10,0 mm	130 mm, 5 "	40-046-02	40-047-02	40-049-02
2,0 x 10,0 mm	150 mm, 6 "	40-050-02	40-051-02	40-053-02
2,0 x 10,0 mm	180 mm, 7 "	40-066-02	40-067-02	40-069-02
2,0 x 10,0 mm	200 mm, 8 "	40-066-12	40-067-12	40-069-12
2,0 x 10,0 mm	230 mm, 9 "	40-066-22		

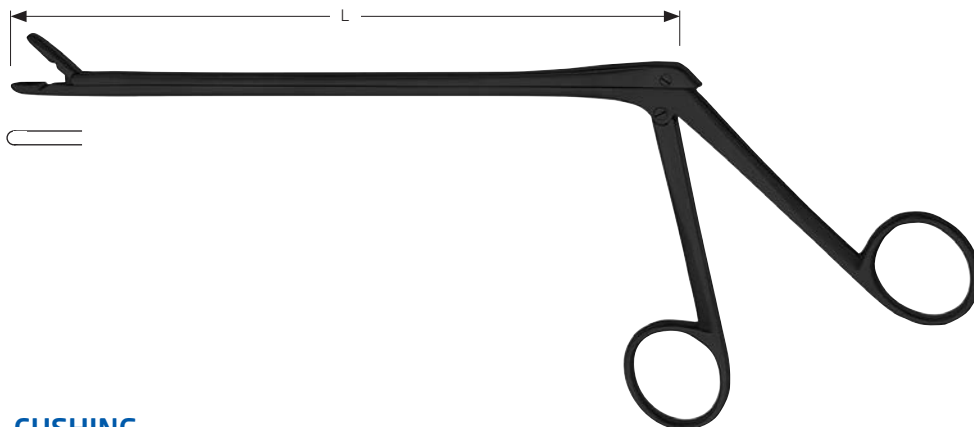

B
CERAMIC

CUSHING

	L			
Bissbreite Width of bite Ancura de la boca Larghezza del morso	Schaftlänge Length of shaft Longitud del vástago Lunghezza dell'asta	gerade straight recta retta	aufgebogen 30° curved up 30° curva hacia arriba 30° curva verso l'alto 30°	abwärts gebogen 30° curved down 30° curva hacia abajo 30° curva verso il basso 30°
2,0 x 10,0 mm	130 mm, 5 "	40-046-02 B	40-047-02 B	40-049-02 B
2,0 x 10,0 mm	150 mm, 6 "	40-050-02 B	40-051-02 B	40-053-02 B
2,0 x 10,0 mm	180 mm, 7 "	40-066-02 B	40-067-02 B	40-069-02 B
2,0 x 10,0 mm	200 mm, 8 "	40-066-12 B	40-067-12 B	40-069-12 B
2,0 x 10,0 mm	230 mm, 9 "	40-066-22 B		

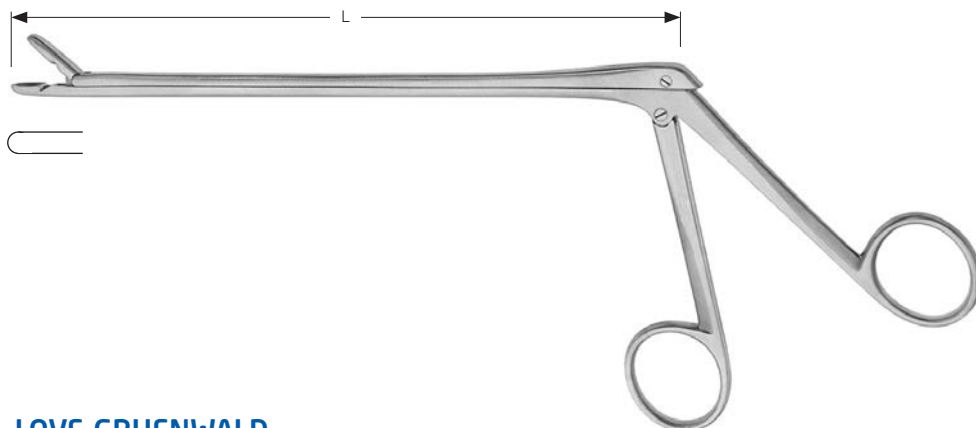

STEEL
STAINLESS

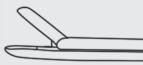
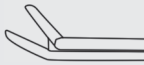
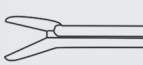

LOVE-GRUENWALD

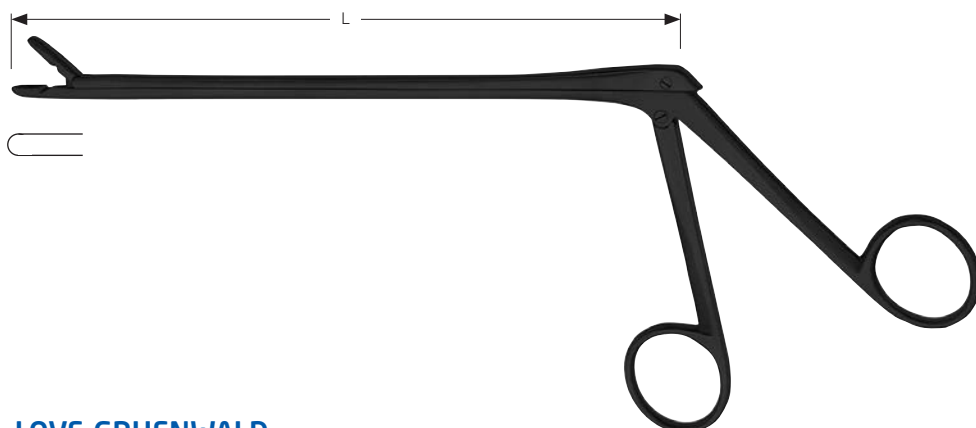
Bissbreite Width of bite Ancura de la boca Larghezza del morso	L Schaftlänge Length of shaft Longitud del vástago Lunghezza dell'asta	 gerade straight recta retta	 aufgebogen 30° curved up 30° curva hacia arriba 30° curva verso l'alto 30°	 abwärts gebogen 30° curved down 30° curva hacia abajo 30° curva verso il basso 30°
3,0 x 10,0 mm	130 mm, 5"	40-046-03	40-047-03	40-049-03
3,0 x 10,0 mm	150 mm, 6"	40-050-03	40-051-03	40-053-03
3,0 x 10,0 mm	180 mm, 7"	40-066-03	40-067-03	40-069-03
3,0 x 10,0 mm	200 mm, 8"	40-066-13	40-067-13	40-069-13
3,0 x 10,0 mm	230 mm, 9"	40-066-23		

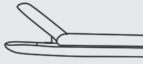

B
CERAMIC

LOVE-GRUENWALD

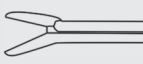
Bissbreite Width of bite Ancura de la boca Larghezza del morso	L Schaftlänge Length of shaft Longitud del vástago Lunghezza dell'asta	 gerade straight recta retta	 aufgebogen 30° curved up 30° curva hacia arriba 30° curva verso l'alto 30°	 abwärts gebogen 30° curved down 30° curva hacia abajo 30° curva verso il basso 30°
3,0 x 10,0 mm	130 mm, 5"	40-046-03 B	40-047-03 B	40-049-03 B
3,0 x 10,0 mm	150 mm, 6"	40-050-03 B	40-051-03 B	40-053-03 B
3,0 x 10,0 mm	180 mm, 7"	40-066-03 B	40-067-03 B	40-069-03 B
3,0 x 10,0 mm	200 mm, 8"	40-066-13 B	40-067-13 B	40-069-13 B
3,0 x 10,0 mm	230 mm, 9"	40-066-23 B		

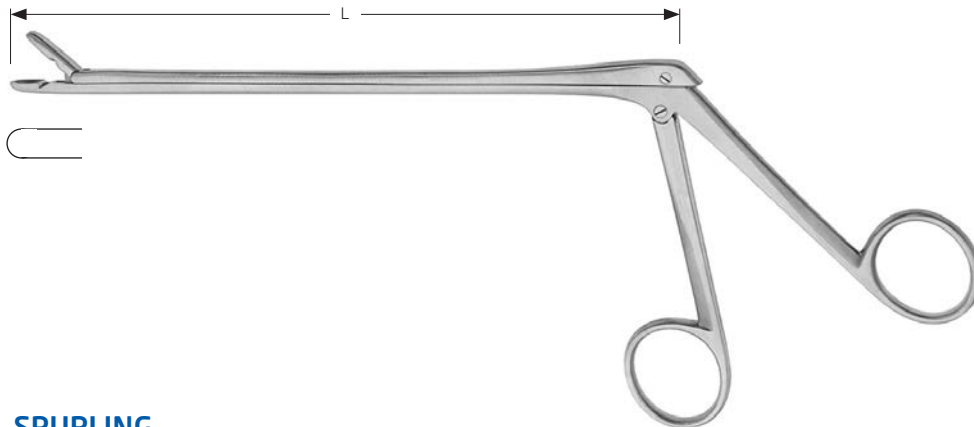

STEEL
STAINLESS

SPURLING

	L			
Bissbreite Width of bite Ancura de la boca Larghezza del morso	Schaftlänge Length of shaft Longitud del vástago Lunghezza dell'asta	gerade straight recta retta	aufgebogen 30° curved up 30° curva hacia arriba 30° curva verso l'alto 30°	abwärts gebogen 30° curved down 30° curva hacia abajo 30° curva verso il basso 30°
4,0 x 10,0 mm	130 mm, 5 "	40-046-04	40-047-04	40-049-04
4,0 x 10,0 mm	150 mm, 6 "	40-050-04	40-051-04	40-053-04
4,0 x 10,0 mm	180 mm, 7 "	40-066-04	40-067-04	40-069-04
4,0 x 10,0 mm	200 mm, 8 "	40-066-14	40-067-14	40-069-14
4,0 x 10,0 mm	230 mm, 9 "	40-066-24		

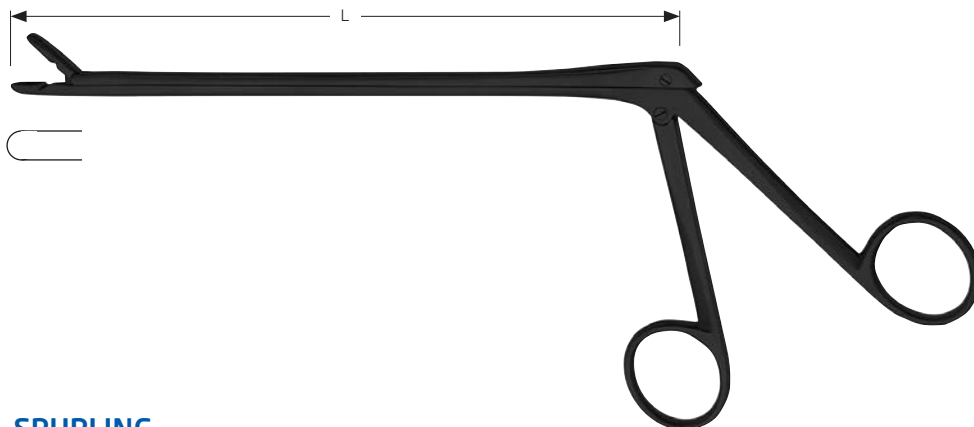

B
CERAMIC

SPURLING

	L			
Bissbreite Width of bite Ancura de la boca Larghezza del morso	Schaftlänge Length of shaft Longitud del vástago Lunghezza dell'asta	gerade straight recta retta	aufgebogen 30° curved up 30° curva hacia arriba 30° curva verso l'alto 30°	abwärts gebogen 30° curved down 30° curva hacia abajo 30° curva verso il basso 30°
4,0 x 10,0 mm	130 mm, 5 "	40-046-04 B	40-047-04 B	40-049-04 B
4,0 x 10,0 mm	150 mm, 6 "	40-050-04 B	40-051-04 B	40-053-04 B
4,0 x 10,0 mm	180 mm, 7 "	40-066-04 B	40-067-04 B	40-069-04 B
4,0 x 10,0 mm	200 mm, 8 "	40-066-14 B	40-067-14 B	40-069-14 B
4,0 x 10,0 mm	230 mm, 9 "	40-066-24 B		

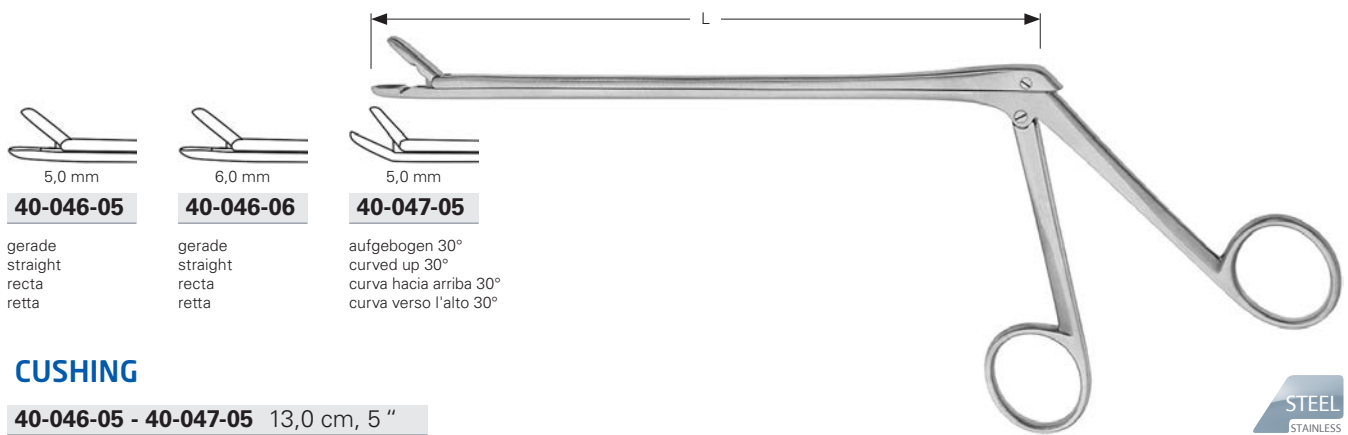

5,0 mm
40-046-05

gerade
straight
recta
retta

6,0 mm
40-046-06

gerade
straight
recta
retta

5,0 mm
40-047-05

aufgebogen 30°
curved up 30°
curva hacia arriba 30°
curva verso l'alto 30°

CUSHING

40-046-05 - 40-047-05 13,0 cm, 5 "

STEEL
STAINLESS

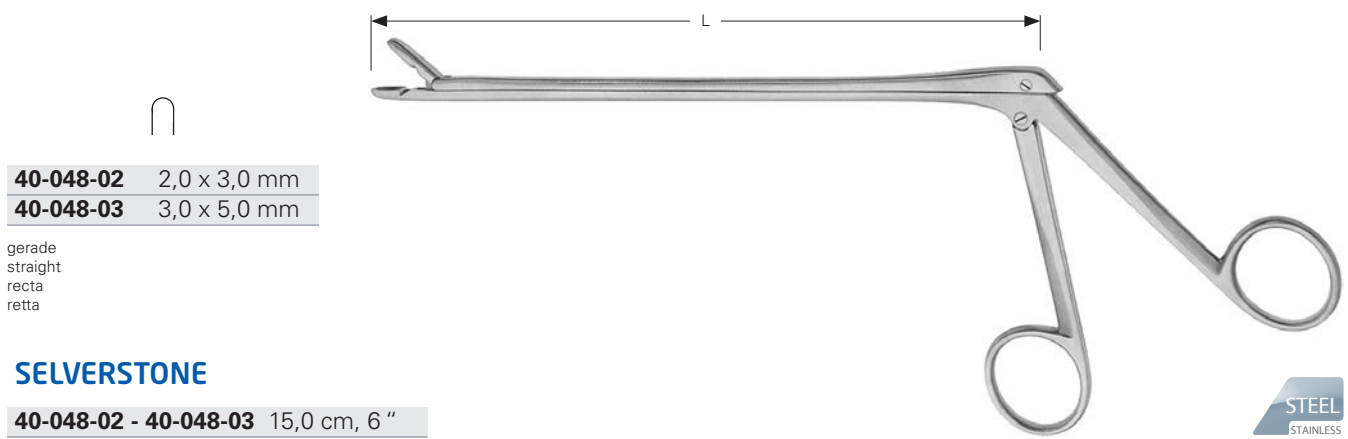

40-048-02 2,0 x 3,0 mm
40-048-03 3,0 x 5,0 mm

gerade
straight
recta
retta

SELVERSTONE

40-048-02 - 40-048-03 15,0 cm, 6 "

STEEL
STAINLESS



40-048-12 2,0 x 10,0 mm
40-048-13 3,0 x 10,0 mm

aufgebogen 30°
curved up 30°
curva hacia arriba 30°
curva verso l'alto 30°

SELVERSTONE

40-048-12 - 40-048-13 15,0 cm, 6 "

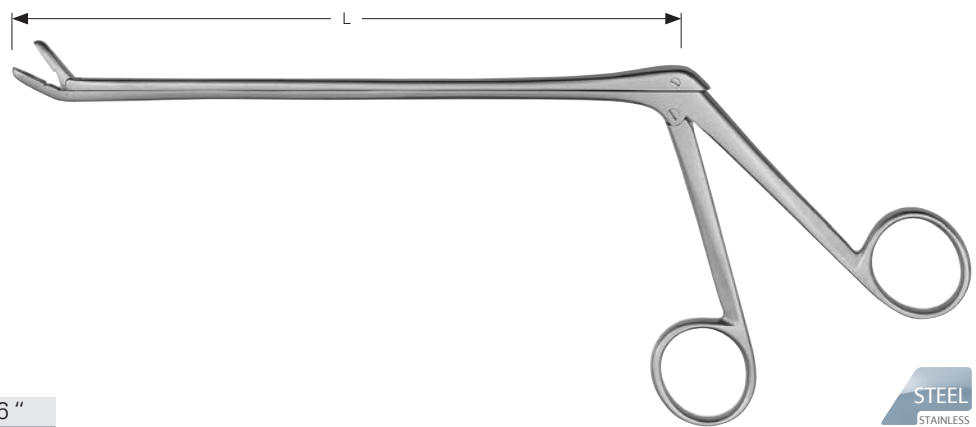

STEEL
STAINLESS



40-050-05 5,0 mm

gerade
straight
recta
retta

CASPAR

40-050-05 15,0 cm, 6 "

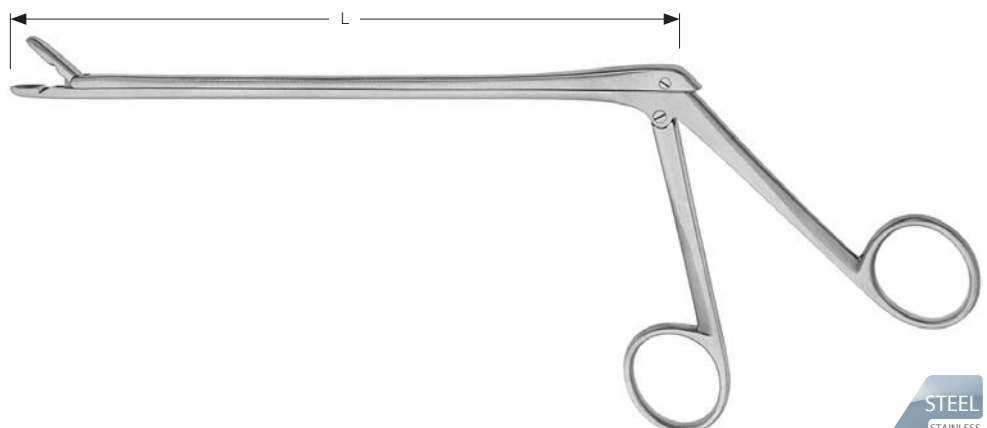

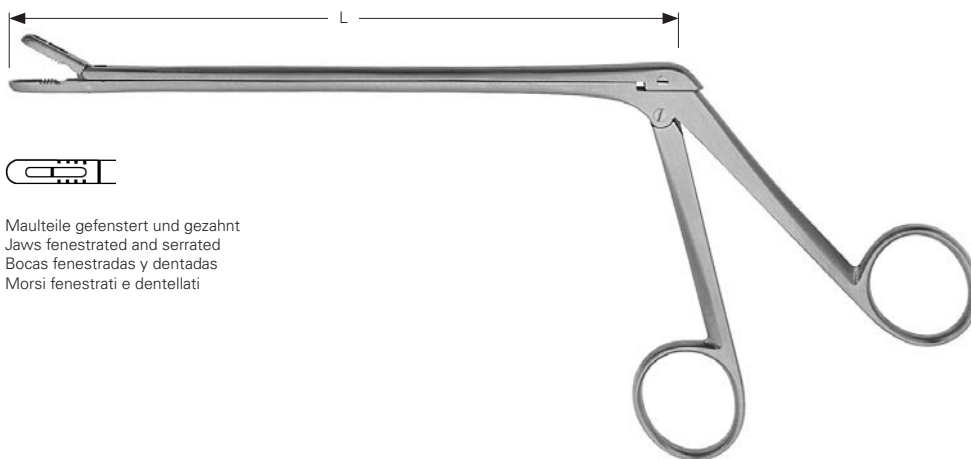

STEEL
STAINLESS



Maulteile gefenestert und gezahnt
Jaws fenestrated and serrated
Bocas fenestradas y dentadas
Morsi fenestrati e dentellati

STEEL
STAINLESS

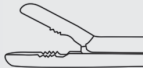
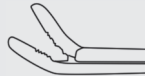
CASPAR

	L			
Bissbreite Width of bite Ancura de la boca Larghezza del morso	Schaftlänge Length of shaft Longitud del vástago Lunghezza dell'asta	gerade straight recta retta	aufgebogen 30° curved up 30° curva hacia arriba 30° curva verso l'alto 30°	abwärts gebogen 30° curved down 30° curva hacia abajo 30° curva verso il basso 30°
2,0 x 12,0 mm	140 mm, 5 1/2"	40-054-02	40-055-02	40-061-02
3,0 x 12,0 mm	140 mm, 5 1/2"	40-054-03	40-055-03	40-061-03
4,0 x 14,0 mm	140 mm, 5 1/2"	40-054-04	40-055-04	40-061-04
5,0 x 14,0 mm	140 mm, 5 1/2"	40-054-05	40-055-05	40-061-05
6,0 x 16,0 mm	140 mm, 5 1/2"	40-054-06		
2,0 x 12,0 mm	160 mm, 6 1/4"	40-056-02	40-057-02	40-063-02
3,0 x 12,0 mm	160 mm, 6 1/4"	40-056-03	40-057-03	40-063-03
4,0 x 14,0 mm	160 mm, 6 1/4"	40-056-04	40-057-04	40-063-04
5,0 x 14,0 mm	160 mm, 6 1/4"	40-056-05	40-057-05	40-063-05
6,0 x 16,0 mm	160 mm, 6 1/4"	40-056-06		
2,0 x 12,0 mm	185 mm, 7 1/4"	40-058-02	40-059-02	40-065-02
3,0 x 12,0 mm	185 mm, 7 1/4"	40-058-03	40-059-03	40-065-03
4,0 x 14,0 mm	185 mm, 7 1/4"	40-058-04	40-059-04	40-065-04
5,0 x 14,0 mm	185 mm, 7 1/4"	40-058-05	40-059-05	40-065-05
6,0 x 16,0 mm	185 mm, 7 1/4"	40-058-06		



Maulteile gefenestert und gezahnt
Jaws fenestrated and serrated
Bocas fenestradas y dentadas
Morsi fenestrati e dentellati



CASPAR

Bissbreite Width of bite Ancura de la boca Larghezza del morso	L Schaftlänge Length of shaft Longitud del vástago Lunghezza dell'asta	 gerade straight recta retta	 aufgebogen 30° curved up 30° curva hacia arriba 30° curva verso l'alto 30°	 abwärts gebogen 30° curved down 30° curva hacia abajo 30° curva verso il basso 30°
2,0 x 12,0 mm	140 mm, 5 1/2"	40-054-02 B	40-055-02 B	40-061-02 B
3,0 x 12,0 mm	140 mm, 5 1/2"	40-054-03 B	40-055-03 B	40-061-03 B
4,0 x 14,0 mm	140 mm, 5 1/2"	40-054-04 B	40-055-04 B	40-061-04 B
5,0 x 14,0 mm	140 mm, 5 1/2"	40-054-05 B	40-055-05 B	40-061-05 B
6,0 x 16,0 mm	140 mm, 5 1/2"	40-054-06 B		
2,0 x 12,0 mm	160 mm, 6 1/4"	40-056-02 B	40-057-02 B	40-063-02 B
3,0 x 12,0 mm	160 mm, 6 1/4"	40-056-03 B	40-057-03 B	40-063-03 B
4,0 x 14,0 mm	160 mm, 6 1/4"	40-056-04 B	40-057-04 B	40-063-04 B
5,0 x 14,0 mm	160 mm, 6 1/4"	40-056-05 B	40-057-05 B	40-063-05 B
6,0 x 16,0 mm	160 mm, 6 1/4"	40-056-06 B		
2,0 x 12,0 mm	185 mm, 7 1/4"	40-058-02 B	40-059-02 B	40-065-02 B
3,0 x 12,0 mm	185 mm, 7 1/4"	40-058-03 B	40-059-03 B	40-065-03 B
4,0 x 14,0 mm	185 mm, 7 1/4"	40-058-04 B	40-059-04 B	40-065-04 B
5,0 x 14,0 mm	185 mm, 7 1/4"	40-058-05 B	40-059-05 B	40-065-05 B
6,0 x 16,0 mm	185 mm, 7 1/4"	40-058-06 B		



Maulteile gefenstert und gezahnt
Jaws fenestrated and serrated
Bocas fenestradas y dentadas
Morsi fenestrati e dentellati

STEEL
STAINLESS

CASPAR

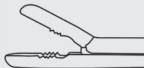
	L		
Bissbreite Width of bite Ancura de la boca Larghezza del morso	Schaftlänge Length of shaft Longitud del vástago Lunghezza dell'asta	gerade straight recta retta	aufgebogen 30° curved up 30° curva hacia arriba 30° curva verso l'alto 30°
2,0 mm	180 mm, 7"	40-058-02 Z	40-059-02 Z
3,0 mm	180 mm, 7"	40-058-03 Z	40-059-03 Z
4,0 mm	180 mm, 7"	40-058-04 Z	40-059-04 Z
5,0 mm	180 mm, 7"	40-058-05 Z	40-059-05 Z
6,0 mm	180 mm, 7"	40-058-06 Z	40-059-06 Z
2,0 mm	200 mm, 8"	40-058-12 Z	40-059-12 Z
3,0 mm	200 mm, 8"	40-058-13 Z	40-059-13 Z
4,0 mm	200 mm, 8"	40-058-14 Z	40-059-14 Z
5,0 mm	200 mm, 8"	40-058-15 Z	40-059-15 Z
6,0 mm	200 mm, 8"	40-058-16 Z	40-059-16 Z
2,0 mm	230 mm, 9"	40-058-22 Z	40-059-22 Z
3,0 mm	230 mm, 9"	40-058-23 Z	40-059-23 Z
4,0 mm	230 mm, 9"	40-058-24 Z	40-059-24 Z
5,0 mm	230 mm, 9"	40-058-25 Z	40-059-25 Z
6,0 mm	230 mm, 9"	40-058-26 Z	40-059-26 Z

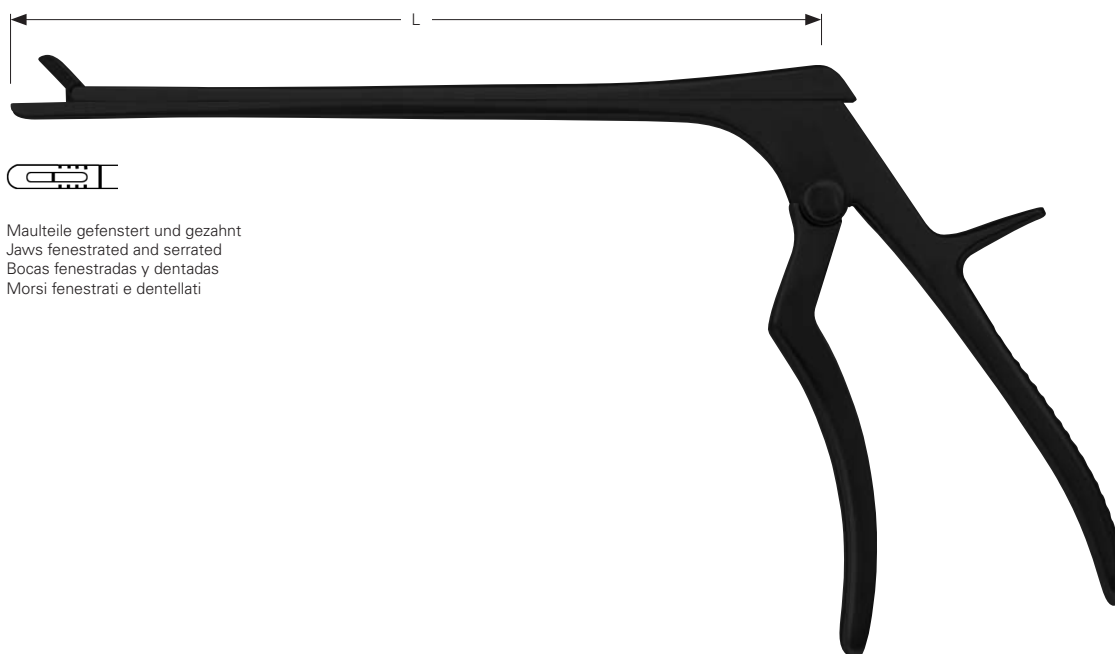

Maulteile gefenestert und gezahnt
 Jaws fenestrated and serrated
 Bocas fenestradas y dentadas
 Morsi fenestrati e dentellati



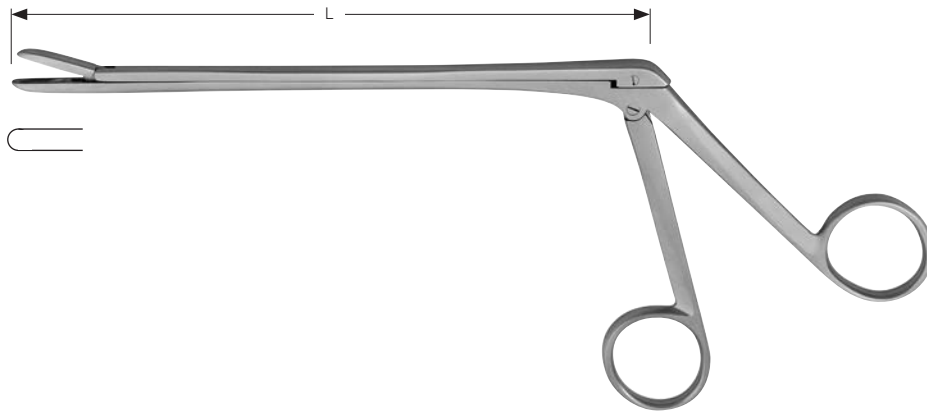

CASPAR

	L		
Bissbreite Width of bite Ancura de la boca Larghezza del morso	Schaftlänge Length of shaft Longitud del vástago Lunghezza dell'asta	gerade straight recta retta	aufgebogen 30° curved up 30° curva hacia arriba 30° curva verso l'alto 30°
2,0 mm	180 mm, 7 "	40-058-02 ZB	40-059-02 ZB
3,0 mm	180 mm, 7 "	40-058-03 ZB	40-059-03 ZB
4,0 mm	180 mm, 7 "	40-058-04 ZB	40-059-04 ZB
5,0 mm	180 mm, 7 "	40-058-05 ZB	40-059-05 ZB
6,0 mm	180 mm, 7 "	40-058-06 ZB	40-059-06 ZB
2,0 mm	200 mm, 8 "	40-058-12 ZB	40-059-12 ZB
3,0 mm	200 mm, 8 "	40-058-13 ZB	40-059-13 ZB
4,0 mm	200 mm, 8 "	40-058-14 ZB	40-059-14 ZB
5,0 mm	200 mm, 8 "	40-058-15 ZB	40-059-15 ZB
6,0 mm	200 mm, 8 "	40-058-16 ZB	40-059-16 ZB
2,0 mm	230 mm, 9 "	40-058-22 ZB	40-059-22 ZB
3,0 mm	230 mm, 9 "	40-058-23 ZB	40-059-23 ZB
4,0 mm	230 mm, 9 "	40-058-24 ZB	40-059-24 ZB
5,0 mm	230 mm, 9 "	40-058-25 ZB	40-059-25 ZB
6,0 mm	230 mm, 9 "	40-058-26 ZB	40-059-26 ZB

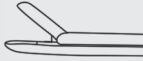

CASPAR

	L			
Bissbreite Width of bite Ancura de la boca Larghezza del morso	Schaftlänge Length of shaft Longitud del vástago Lunghezza dell'asta	gerade straight recta retta	aufgebogen 30° curved up 30° curva hacia arriba 30° curva verso l'alto 30°	abwärts gebogen 30° curved down 30° curva hacia abajo 30° curva verso il basso 30°
2,0 x 12,0 mm	155 mm, 6 1/8"	40-070-02	40-070-12	40-070-22
3,0 x 13,0 mm	155 mm, 6 1/8"	40-070-03	40-070-13	40-070-23
4,0 x 14,0 mm	155 mm, 6 1/8"	40-070-04	40-070-14	40-070-24
5,0 x 14,0 mm	155 mm, 6 1/8"	40-070-05	40-070-15	40-070-25



40-072-03 3,0 mm

gerade
straight
recta
retta

PENNYBACKER

40-072-03 12,0 cm, 4 3/4"





40-072-07 Ø 7,0 mm

gerade
 straight
 recta
 retta

OLDBERG

40-072-07 18,0 cm, 7 "

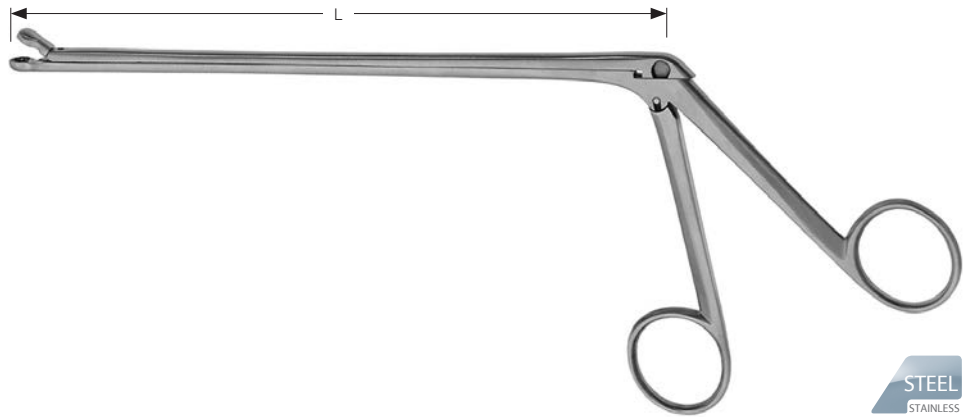

STEEL
 STAINLESS



40-074-09 Ø 9,0 mm

gerade
 straight
 recta
 retta

LANDOLT

40-074-09 20,0 cm, 8 "

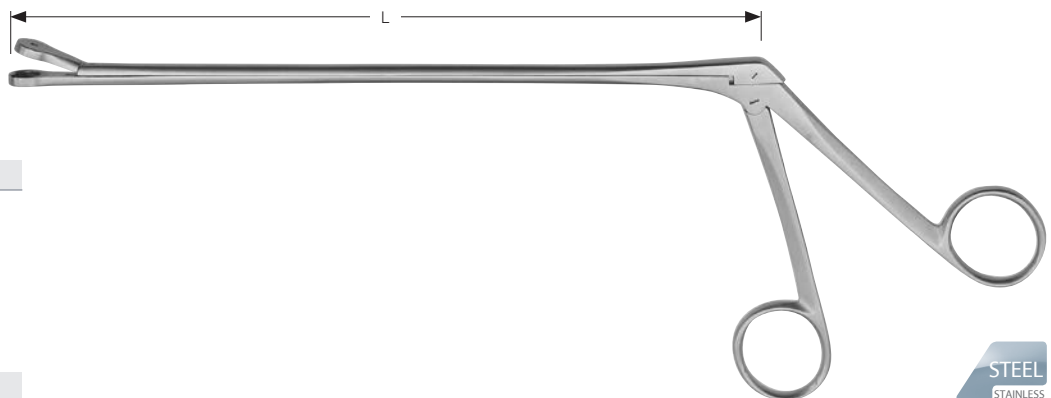

STEEL
 STAINLESS



40-076-22 Ø 2,2 mm

40-076-35 Ø 3,5 mm

gerade
 straight
 recta
 retta

YASARGIL

40-076-22 - 40-076-35 19,0 cm, 7 1/2 "

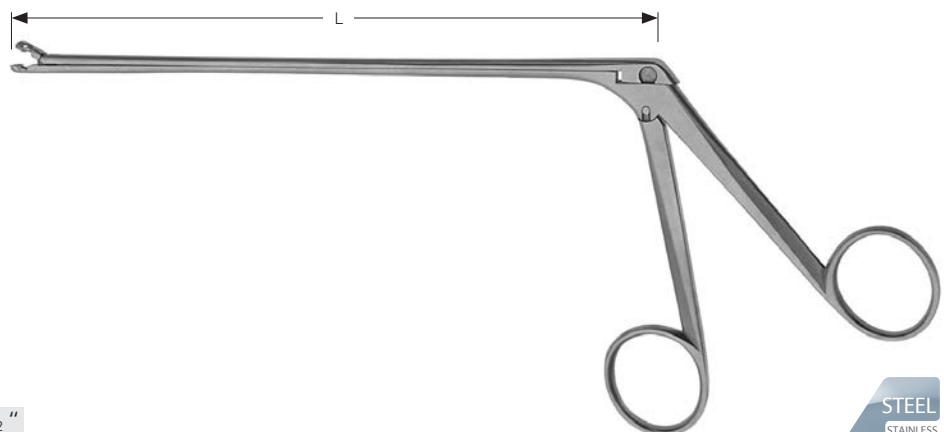

STEEL
 STAINLESS

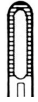

40-078-02	2,0 x 10,0 mm
40-078-03	3,0 x 10,0 mm
40-078-04	4,0 x 10,0 mm

gerade
straight
recta
retta

SCHLESINGER

40-078-02 - 40-078-04 15,0 cm, 6 "

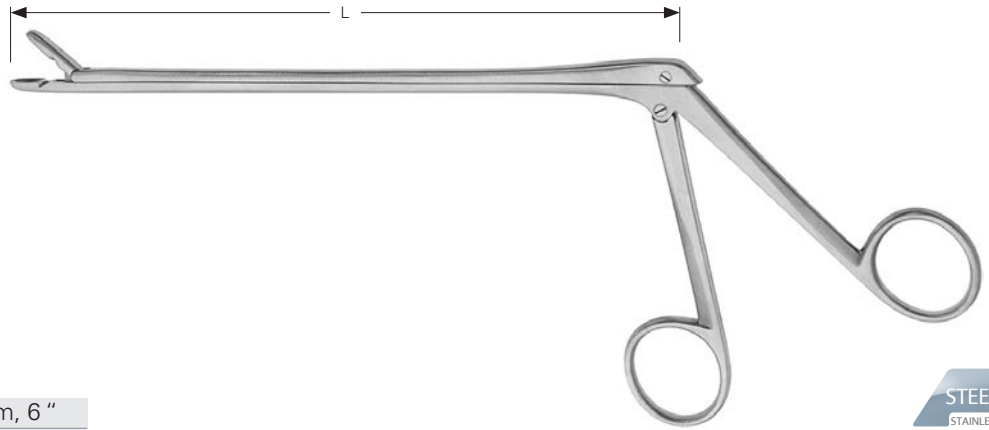

STEEL
STAINLESS

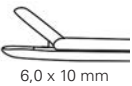

40-078-16

gerade
straight
recta
retta

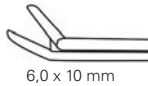

40-078-26

aufgebogen
curved up
curva hacia arriba
curva verso l'alto

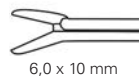

40-078-36

abwärts gebogen
curved down
curva hacia abajo
curva verso il basso

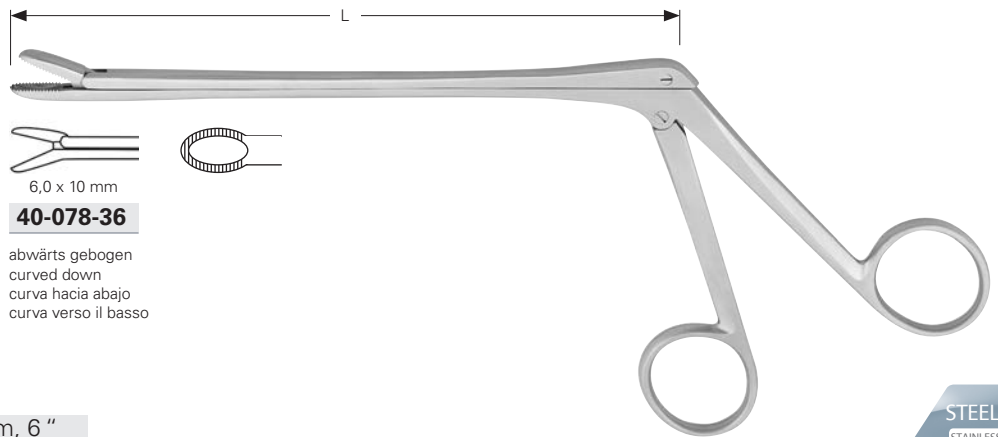
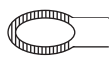

STEEL
STAINLESS

CLOWARD

40-078-16 - 40-078-36 15,0 cm, 6 "

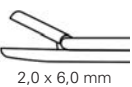

40-080-15

gerade
straight
recta
retta

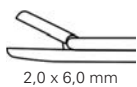

40-081-15

nach links gebogen
curved to left
curvado al lado izquierdo
curvo alla parte di sinistra

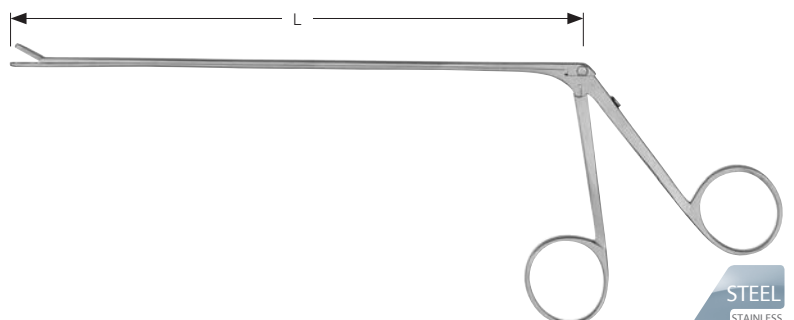

STEEL
STAINLESS

DECKER

40-080-15 - 40-081-15 15,0 cm, 6 "

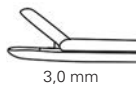

3,0 mm
40-084-03

gerade
 straight
 recta
 retta

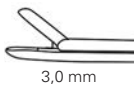

3,0 mm
40-086-03

nach rechts gebogen
 curved to right
 curvado al lado derecha
 curvo alla parte di destra

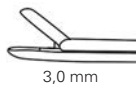

3,0 mm
40-086-13

nach links gebogen
 curved to left
 curvado al lado izquierdo
 curvo alla parte di sinistra

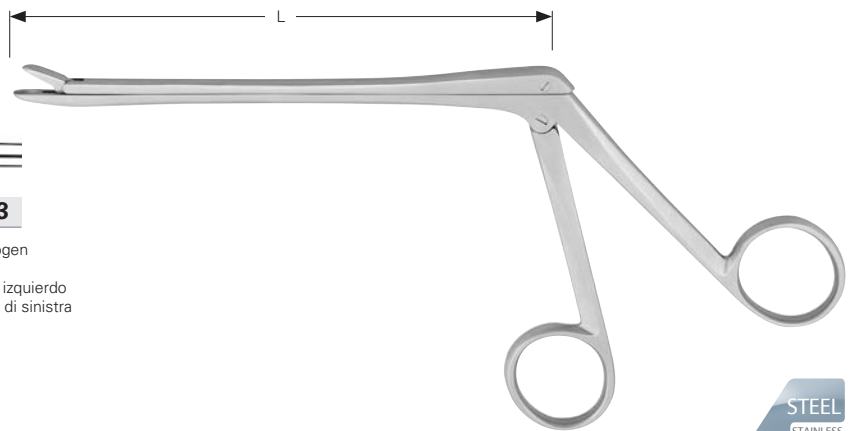

STEEL
 STAINLESS

BAILEY

40-084-03 - 40-086-13 11,5 cm, 4 ½ "

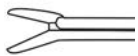

40-085-03 3,0 mm | 25°
40-085-13 3,0 mm | 70°
40-085-23 3,0 mm | 90°

abwärts gebogen
 curved down
 curva hacia abajo
 curva verso il basso

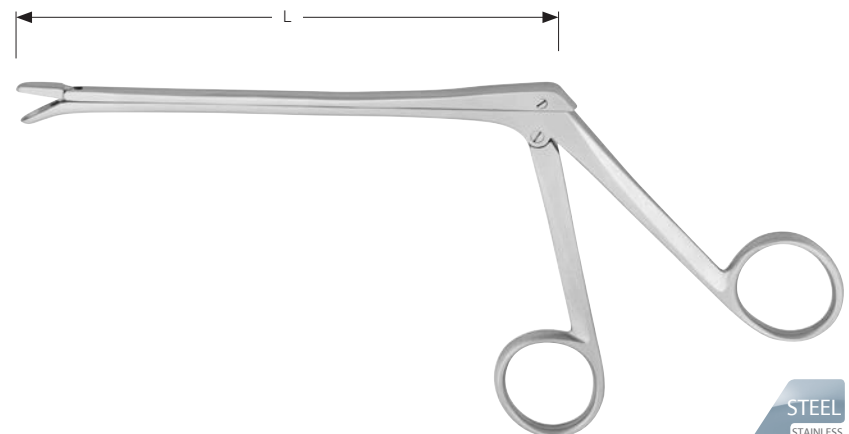

STEEL
 STAINLESS

BAILEY

40-085-03 - 40-085-23 11,5 cm, 4 ½ "

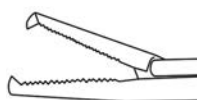

40-090-14

gerade
 straight
 recta
 retta

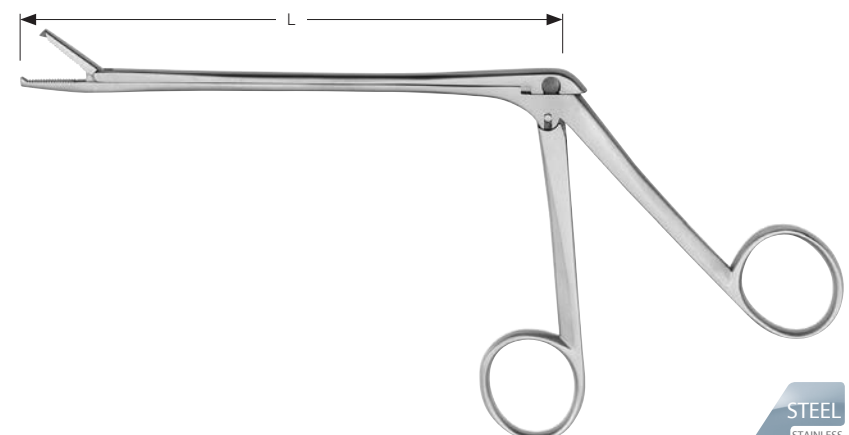

STEEL
 STAINLESS

HOEN

40-090-14 14,0 cm, 5 ½ "

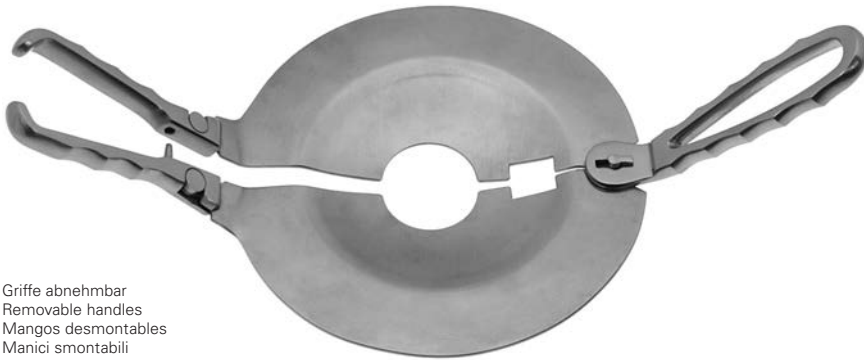

Griffe abnehmbar
Removable handles
Mangos desmontables
Manici smontabili

PERCY

40-117-01



Griffe umlegbar
Reversible handles
Mangos reversibles
Manici reversibili

PERCY

40-117-02



CHARRIÈRE

40-120-00 35,0 cm, 13 3/4 "

mit 2 austauschbaren Sägeblättern 12 mm und 18 mm
with 2 interchangeable saw blades 12 mm and 18 mm
con 2 hojas de sierras intercambiables 12 mm y 18 mm
con 2 lame intercambiabili 12 mm e 18 mm

40-120-12	12,0 x 215 mm
40-120-15	15,0 x 215 mm
40-120-20	18,0 x 215 mm

Ersatzsägeblatt
Spare saw blade
Hoja de repuesto
Lama di ricambio



RUST

40-121-00 39,0 cm, 15 1/2 "

mit 4 austauschbaren Sägeblättern 6 mm, 8 mm, 15 mm und 18 mm
with 4 interchangeable saw blades 6 mm, 8 mm, 15 mm and 18 mm
con 4 hojas de sierras intercambiables 6 mm, 8 mm, 15 mm y 18 mm
con 4 lame intercambiabili 6 mm, 8 mm, 15 mm e 18 mm

40-121-06	6,0 x 235 mm
40-121-08	8,0 x 235 mm
40-121-15	15,0 x 235 mm
40-121-20	18,0 x 235 mm

Ersatzsägeblatt
Spare saw blade
Hoja de repuesto
Lama di ricambio

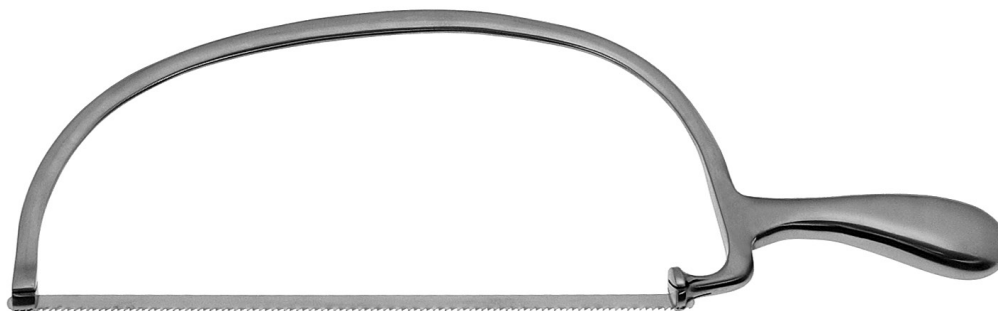

HELFERICH-BIER

40-122-00 40,5 cm, 16 "

mit 3 austauschbaren Sägeblättern 4 mm, 6 mm und 8 mm
with 3 interchangeable saw blades 4 mm, 6 mm and 8 mm
con 3 hojas de sierras intercambiables 4 mm, 6 mm y 8 mm
con 3 lame intercambiabili 4 mm, 6 mm e 8 mm

40-122-04	4,0 x 270 mm
40-122-06	6,0 x 270 mm
40-122-08	8,0 x 270 mm

Ersatzsägeblatt
Spare saw blade
Hoja de repuesto
Lama di ricambio

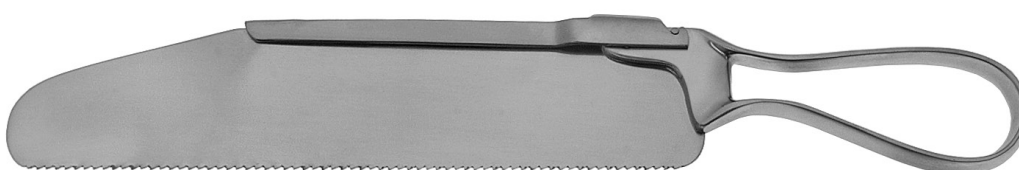

CHARRIÈRE

40-124-00 27,0 cm, 10 3/4 "

mit 1 austauschbarem Sägeblatt
with 1 interchangeable saw blade
con 1 hojas de sierras intercambiables
con 1 lame intercambiabili

40-124-99	180 mm
-----------	--------

Ersatzsägeblatt
Spare saw blade
Hoja de repuesto
Lama di ricambio

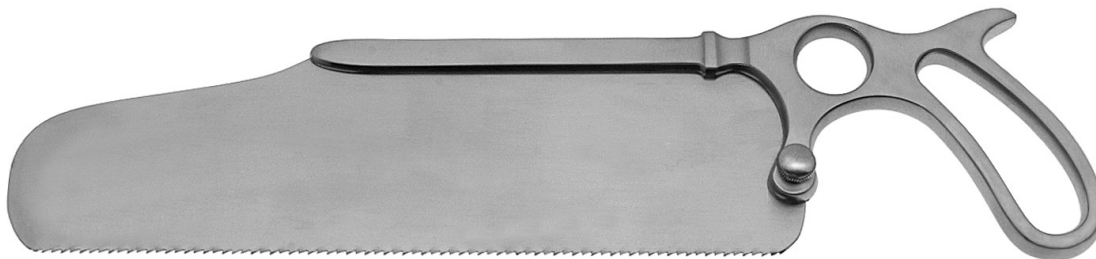

SATTERLEE

40-126-00 29,0 cm, 11 1/2 "

mit 1 austauschbarem Sägeblatt
with 1 interchangeable saw blade
con 1 hojas de sierras intercambiables
con 1 lame intercambiabili

40-126-99 200 mm

Ersatzsägeblatt
Spare saw blade
Hoja de repuesto
Lama di ricambio

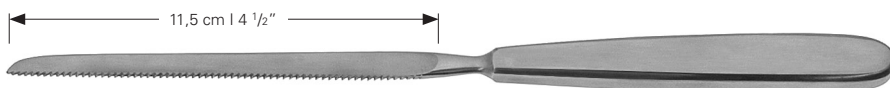

LANGENBECK

40-128-00 23,5 cm, 9 1/4 "

fein
fine
fina
delicata

Handgriff für Drahtsägen
T-Bar handle for wire saws
Mango con gancho, para sierras de hilo
Manico ad uncino per fili per sega

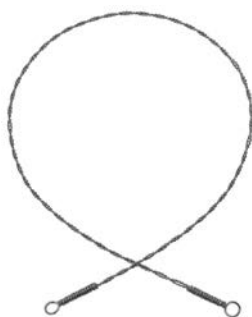
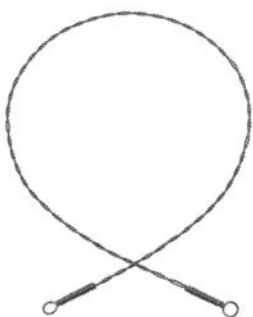

OLIVECRONA

40-130-30 30,0 cm, 12 "
40-130-40 40,0 cm, 16 "
40-130-50 50,0 cm, 20 "
40-130-60 60,0 cm, 24 "
40-130-70 70,0 cm, 28 "

GIGLI

40-132-30 30,0 cm, 12 "
40-132-40 40,0 cm, 16 "
40-132-50 50,0 cm, 20 "
40-132-60 60,0 cm, 24 "
40-132-70 70,0 cm, 28 "

GIGLI

40-135-00 7,0 cm, 2 1/4 "



40-137-01

Ersatzsägeblatt
Spare saw blade
Hoja de repuesto
Lama di ricambio

MARTIN

40-137-00 17,0 cm, 6 3/4 "



40-138-01

Ersatzsägeblatt
Spare saw blade
Hoja de repuesto
Lama di ricambio

WALTON

40-138-00 16,0 cm, 6 1/4 "



40-139-01

Ersatzsägeblatt
Spare saw blade
Hoja de repuesto
Lama di ricambio

40-139-00 17,0 cm, 6 3/4 "



40-140-01

Ersatzsägeblatt
Spare saw blade
Hoja de repuesto
Lama di ricambio

40-140-00 17,0 cm, 6 3/4 "



40-150-14 14,0 cm, 5 1/2"
40-150-16 16,0 cm, 6 1/4"

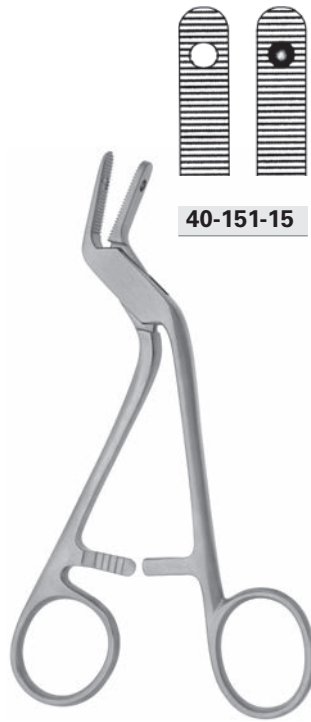

40-151-15

ADSON

40-151-15 15,0 cm, 6"



ADSON

40-152-14 14,0 cm, 5 1/2"



PERTHES

40-154-18 18,0 cm, 7"



PERTHES

40-156-21 21,0 cm, 8 1/4"



Ø 10,0 mm
40-158-18

ZANDER

40-158-18 24,5 cm, 9 2/3"



40-158-30 30,0 cm, 13 1/8"





HW 320 g
TW 420 g
Ø 26,0 mm

40-200-22

Ersatzbacken
Spare discs
Tapas de repuesto
Piastrre di ricambio

MEAD

40-200-20 19,0 cm, 7 1/2"



HW 140 g
TW 240 g
Ø 25,0 mm

40-201-99

Ersatzbacken
Spare discs
Tapas de repuesto
Piastrre di ricambio



MEAD

40-201-25 18,5 cm, 7 1/4"



HW 240 g
TW 340 g
Ø 30,0 mm

40-202-30

1 Seite flach
1 Seite convex
1 side flat
1 side convex
1 lato plano
1 lato convexo
1 lato piatto
1 lato convesso

COTTLE

40-202-30 19,0 cm, 7 1/2"



HW 100 g
TW 140 g
Ø 20,0 mm

40-203-22

mit Bleifüllung
lead filled head
cabezal relleno de plomo
testa di piombo

40-203-22 16,5 cm, 6 1/2"



HW 160 g
TW 220 g
Ø 22,0 mm

40-204-22

mit Bleifüllung
lead filled head
cabezal relleno de plomo
testa di piombo

40-204-22 19,0 cm, 7 1/2"



HW 160 g
TW 220 g
Ø 27,0 mm

40-205-27

HAJEK

40-205-27 20,0 cm, 8"



HW 180 g
TW 240 g
Ø 25,0 mm

40-206-26

Ersatzbacken
Spare discs
Tapas de repuesto
Piastrre di ricambio



HW 230 g
TW 360 g
Ø 30,0 mm

40-206-32

Ersatzbacken
Spare discs
Tapas de repuesto
Piastrre di ricambio



HW 230 g
TW 360 g
Ø 30,0 mm

40-206-32

Ersatzbacken
Spare discs
Tapas de repuesto
Piastrre di ricambio



40-206-25 19,0 cm, 7 1/2 "

40-206-30 25,0 cm, 10 "

40-206-30 P 25,0 cm, 10 "



HW 290 g
TW 480 g
Ø 35,0 mm

40-208-37

Ersatzbacken
Spare discs
Tapas de repuesto
Piastrre di ricambio



HW 470 g
TW 660 g
Ø 35,0 mm

40-208-36

Ersatzbacken
Spare discs
Tapas de repuesto
Piastrre di ricambio



Ersatz-Schlüssel
Spare wrench
Llave de repuesto
Chiave di ricambio



HW 100 g
TW 200 g
Ø 35,0 mm

40-210-35

HW 170 g
TW 260 g
Ø 42,0 mm

40-210-42

HW 220 g
TW 320 g
Ø 50,0 mm

40-210-50



komplett
complete
completo
completo

WAGNER

40-208-35 24,5 cm, 9 3/4 "

WAGNER

40-208-38

40-210-35 - 40-210-50 26,0 cm, 10 1/4 "



HW 300 g
TW 480 g
Ø 30,0 mm

40-211-30

BERGMANN

40-211-30 23,5 cm, 9 ¼ "



HW 380 g
TW 560 g
Ø 45,0 mm

40-211-45

BERGMANN

40-211-45 25,0 cm, 10 "



HW 420 g
TW 600 g
Ø 29 | 42 mm

40-212-42

40-212-42 25,0 cm, 10 "



HW 560 g
TW 740 g
Ø 40,0 mm

40-213-40

OMBREDANNE

40-213-40 25,0 cm, 10 "



HW 700 g
TW 860 g
Ø 40,0 mm

40-214-40

HEATH

40-214-40 18,5 cm, 7 ¼ "



HW 1000 g
TW 1160 g
Ø 45,0 mm

40-214-45

HEATH

40-214-45 20,0 cm, 8 "



HW 160 g
TW 320 g

Ø 26,0 mm

40-215-26

mit Bleifüllung
lead filled head
cabezal relleno de plomo
testa di piombo

HW 240 g
TW 380 g

Ø 30,0 mm

40-215-30

mit Bleifüllung
lead filled head
cabezal relleno de plomo
testa di piombo

HW 200 g
TW 360 g

Ø 28,0 mm

40-215-28

mit Bleifüllung
lead filled head
cabezal relleno de plomo
testa di piombo

WILLIGER

40-215-26 - 40-215-30 24,0 cm, 9 ½ "



HW 100 g
TW 120 g

Ø 25,0 mm

40-216-25

HW 220 g
TW 240 g

Ø 35,0 mm

40-216-35

HW 140 g
TW 180 g

Ø 30,0 mm

40-216-30

DOYEN

40-216-25 - 40-216-35 19,5 cm, 7 ¾ "



HW 220 g
TW 240 g

Ø 30,0 mm

40-217-30

COLLIN

40-217-30 20,0 cm, 8 "



HW 120 g
TW 200 g

Ø 19,0 mm

40-218-19

HW 160 g
TW 260 g

Ø 30,0 mm

40-218-30

HW 140 g
TW 240 g

Ø 25,0 mm

40-218-25

LUCAE

40-218-19 - 40-218-30 19,5 cm, 7 ¾ "



HW 100 g
TW 140 g
Ø 20,0 mm

40-219-20

mit Bleifüllung
lead filled head
cabezal relleno de plomo
testa di piombo

HW 75 g
TW 130 g
Ø 20,0 mm

40-219-21

mit Messingfüllung
brass filled head
cabezal relleno de latón
testa di ottone

40-219-20 - 40-219-21 16,5 cm, 6 1/2"



HW 260 g
TW 360 g
Ø 25,0 mm

40-220-01

mit Bleifüllung
lead filled head
cabezal relleno de plomo
testa di piombo

GERZOG

40-220-01 19,0 cm, 7 1/2"



HW 680 g
TW 780 g
Ø 40,0 mm

40-220-02

KIRK

40-220-02 21,0 cm, 8 1/4"



HW 160 g
TW 200 g
Ø 22,0 mm

40-222-22

mit Bleifüllung
lead filled head
cabezal relleno de plomo
testa di piombo

HW 120 g
TW 160 g
Ø 22,0 mm

40-222-23

PARTSCH

40-222-22 - 40-222-23 19,0 cm, 7 1/2"



HW 300 g
TW 500 g
Ø 30,0 mm

40-221-30



40-221-30 26,5 cm, 10 1/2"



HW 300 g
TW 500 g
Ø 30,0 mm

40-221-30 P



40-221-30 P 26,5 cm, 10 1/2"



HW 300 g
TW 360 g
Ø 80 x 60 mm

40-223-60



STEINBACH

40-223-60 24,0 cm, 9 ½"



HW 250 g
TW 350 g
Ø 42,0 mm

40-224-42

mit Bleifüllung
lead filled head
cabezal relleno de plomo
testa di piombo



40-224-42 26,0 cm, 10 ¼"



HW 170 g
TW 260 g
Ø 42,0 mm

40-225-42



40-225-42 26,0 cm, 10 ¼"



HW 240 g
TW 340 g
Ø 42,0 mm

40-226-42

mit Bleifüllung
lead filled head
cabezal relleno de plomo
testa di piombo



40-226-42 26,0 cm, 10 ¼"



HW 45 g
TW 125 g
Ø 33,0 mm

40-227-30



40-227-30 22,0 cm, 8 ¾"



HW 440 g
TW 640 g
Ø 30 | 42 mm

40-228-42



40-228-42 26,0 cm, 10 ¼"



HW 440 g
TW 640 g
Ø 30 | 42 mm

40-228-42 P



HW 500 g
TW 700 g

Ø 30,0 mm

40-229-99

Ersatzbacken
Spare discs
Tapas de repuesto
Piastrre di ricambio



HW 500 g
TW 700 g

Ø 30,0 mm

40-229-99

Ersatzbacken
Spare discs
Tapas de repuesto
Piastrre di ricambio



40-228-42 P 26,0 cm, 10 ¼"

40-229-29 26,5 cm, 10 ½"

40-229-99 P 26,5 cm, 10 ½"



HW 450 g
TW 640 g
Ø 30,0 mm

40-230-45



HW 900 g
TW 1100 g

Ø 50,0 mm

40-230-90



HW 450 g
TW 640 g
Ø 30,0 mm

40-230-45 P



HW 900 g
TW 1100 g

Ø 50,0 mm

40-230-90 P

40-230-45 - 40-230-90 26,5 cm, 10 ¼"

40-230-45 P - 40-230-90 P 26,5 cm, 10 ¼"



HW 380 g
TW 460 g
Ø 30,0 mm

40-231-48



40-231-48 24,0 cm, 9 ½"

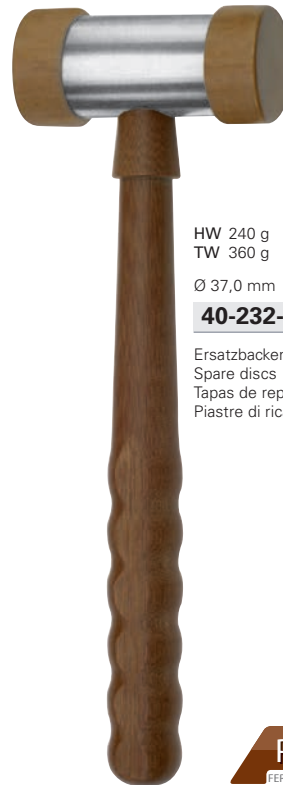

HW 240 g
TW 360 g
Ø 37,0 mm

40-232-42

Ersatzbacken
Spare discs
Tapas de repuesto
Piastrre di ricambio



40-232-37 24,0 cm, 9 ½"



HW 180 g
TW 300 g
Ø 30,0 mm

40-234-35

HW 350 g
TW 500 g
Ø 40,0 mm

40-234-70



40-234-35 - 40-234-70 24,0 cm, 9 ½"



HW 420 g
TW 600 g
Ø 24 | 14 mm

40-235-00

40-235-00 23,5 cm, 9 ¼"



HW 260 g
TW 400 g
Ø 20,0 mm

40-236-23

40-236-23 23,0 cm, 9"



Autopsie-Besteck
 Post mortem set
 Juego de autopsia
 Set per autopsia

40-240-00



40-240-14 14,0 cm, 5 1/2"



VIRCHOW

40-240-15 7,5 cm, 3"



Osteotom
 Osteotome
 Osteotómo
 Osteotomo

40-241-23 13,0 cm, 5 1/8"



23,0 mm

40-241-23



40-242-22 22,0 cm, 8 3/4"



- Robuste Konstruktion
- Hohe Belastbarkeit im Dauerbetrieb
- Vibrationsarm
- Eingebauter Überlastungsschutz
- Construcción robusta
- Alta capacidad de carga también en régimen continuo
- Amortiguación de la vibración
- Protección incorporada contra sobrecarga
- Robust construction
- Maximum capacity also in permanent service
- Low vibration
- Built-in overload protection
- Construzione robusta
- Alta capacità di carica a regime continuo
- Vibrazioni attenuate al minimo
- Protezione di sovraccarico incorporata

Standard Modell
Standard pattern
Modelo estándar
Modello standard



ELECTRO POWER

40-244-00	230 V 50 Hz
40-244-01	110 V 60 Hz

Komplett, bestehend aus:	Complete, consisting of:
1 Oszillierende Autopsiesäge	1 Oscillating autopsy saw
1 Sägeblatt, Ø 50 mm 48-110-50	1 Saw blade, Ø 50 mm 48-110-50
1 Sägeblatt, Ø 65 mm 48-110-65	1 Saw blade, Ø 65 mm 48-110-65
1 Sägeblatt, Ø 65 mm 48-130-65	1 Saw blade, Ø 65 mm 48-130-65
1 Gabelschlüssel, paar 48-110-01	1 Wrench, pair 48-110-01

Completo, compuesto de:	Completo, composto da:
1 Sierra oscilante para autopsia	1 Seghe oscillante per autopsia
1 Hoja de sierra, Ø 50 mm 48-110-50	1 Sega, Ø 50 mm 48-110-50
1 Hoja de sierra, Ø 65 mm 48-110-65	1 Sega, Ø 65 mm 48-110-65
1 Hoja de sierra, Ø 65 mm 48-130-65	1 Sega, Ø 65 mm 48-130-65
1 Llaves de boca, par 48-110-01	1 Chiavi fisse, paio 48-110-01

Aufnahme mit Dreikantschaft
Triangular shaft adaptor for saw blades
Vestago adaptador triangular para hojas de sierra
Adattatore ad asta trianolare per lame da sega



ELECTRO POWER

40-244-03	230 V 50 Hz
40-244-04	110 V 60 Hz

Komplett, bestehend aus:	Complete, consisting of:
1 Oszillierende Autopsiesäge	1 Oscillating autopsy saw
1 Sägeblatt, Ø 50 mm 48-110-50	1 Saw blade, Ø 50 mm 48-110-50
1 Sägeblatt, Ø 65 mm 48-110-65	1 Saw blade, Ø 65 mm 48-110-65
1 Sägeblatt, Ø 65 mm 48-130-65	1 Saw blade, Ø 65 mm 48-130-65
1 Gabelschlüssel, paar 48-110-01	1 Wrench, pair 48-110-01

Completo, compuesto de:	Completo, composto da:
1 Sierra oscilante para autopsia	1 Seghe oscillante per autopsia
1 Hoja de sierra, Ø 50 mm 48-110-50	1 Sega, Ø 50 mm 48-110-50
1 Hoja de sierra, Ø 65 mm 48-110-65	1 Sega, Ø 65 mm 48-110-65
1 Hoja de sierra, Ø 65 mm 48-130-65	1 Sega, Ø 65 mm 48-130-65
1 Llaves de boca, par 48-110-01	1 Chiavi fisse, paio 48-110-01

Technische Daten

Anschlußspannung 230 V~, 50 Hz / 110 V~, 60 Hz
Leistung 500 Watt
Schwingungen 6.500 bis 24.000 Schwingungen / Minute stufenlos regulierbar.
Anschlußkabel 5 Meter-Kabel mit Euro-Flachstecker (230 V)
3 Meter-Kabel mit USA-Stecker (110 V)

Datos técnicos

Tensión de alimentación 230 V~, 50 Hz / 110 V~, 60 Hz
Potencia absorbida 500 Watt
Oscilaciones de 6.500 a 24.000 oscilaciones por minuto regulación progresiva.
Cable de alimentación: Cable de 5 metros con enchufe plano para Europa (230 V) Cable de 3 metros con enchufe para EE.UU. (110 V)

Technical data

Supply voltage 230 V~, 50 Hz / 110 V~, 60 Hz
Power 500 Watt
Oscillations 6.500 to 24.000 oscillations / minute steplessly adjustable
Connection cable 5 meter cable with Euro-plug (230 V)
3 meter cable with USA-plug (110 V)

Dati tecnici

Tensione di collagamento 230 V~, 50 Hz / 110 V~, 60 Hz
Potenza assorbita 500 Watt
Oscillazioni da 6.500 a 24.000 oscillazioni al minuto, con regolazione continua
Cavo di collegamento: Cavo da 5 metri con spina piatta europea (230 V)
Cavo di 3 metri con spina USA (110 V)

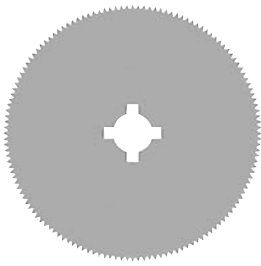

48-110-45 Ø 45,0 mm

48-110-50 Ø 50,0 mm

48-110-65 Ø 65,0 mm

Sägeblatt für Naturgipsverbände
 Saw blade for normal plaster
 Hoja de sierra para vendaje de yeso
 Sega per bendaggi in gesso naturale

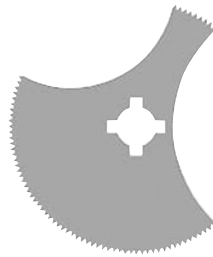

48-130-65 Ø 65,0 mm

Sägeblatt Autopsie für Naturgipsverbände
 Autopsy saw blade for normal plaster
 Hoja de sierra de autopsia para vendaje de yeso
 Sega autopsia per bendaggi in gesso naturale

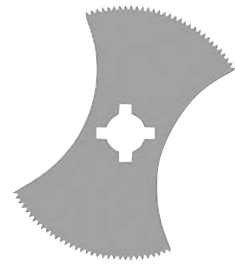

48-150-65 Ø 65,0 mm

Sägeblatt Segment für Naturgipsverbände
 Segmented saw blade for normal plaster
 Hoja de sierra de segmentos para vendaje de yeso
 Sega segmento per bendaggi in gesso naturale

48-120-45 Ø 45,0 mm

48-120-50 Ø 50,0 mm

48-120-65 Ø 65,0 mm

Sägeblatt für synthetische Hartverbände
 Saw blade for synthetic casts
 Hoja de sierra de profundidad para vendajes sintéticos rígidos
 Sega per bendaggi duri sintetici

48-140-65 Ø 65,0 mm

Sägeblatt Autopsie für synthetische Hartverbände
 Autopsy saw blade for synthetic casts
 Hoja de sierra de autopsia para vendajes sintéticos rígidos
 Sega autopsia per bendaggi duri sintetici

48-160-65 Ø 65,0 mm

Sägeblatt Segment für synthetische Hartverbände
 Segmented saw blade for synthetic casts
 Hoja de sierra de segmentos para vendajes sintéticos rígidos
 Sega segmento per bendaggi duri sintetici

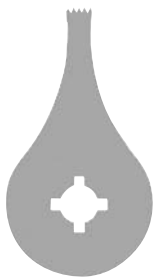

48-170-08 8,0 mm

48-170-20 20,0 mm

Tiefensägeblatt für Naturgipsverbände
 Deep saw blade for normal plaster
 Hoja de sierra de profundidad para vendaje de yeso
 Sega a taglio di profondità per bendaggi in gesso naturale

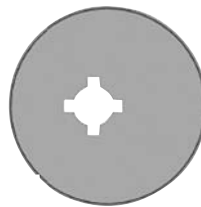

48-190-99 Ø 65,0 mm

Exzentrische Begrenzungsscheibe für Tiefenbegrenzung
 Excentric disc to limit depth of cut
 Disco de tope excéntrico para tope de profundidad
 Disco di limitazione eccentrico per limitazione della profondità



48-110-01

Gabelschlüssel für Sägeblattwechsel, Paar
 Wrenches for exchange of saw blades, pair
 Llaves de boca para cambiar la hoja de sierra, par
 Chiavi per cambiare la lama per sega, paio

48-180-08 8,0 mm

48-180-20 20,0 mm

Tiefensägeblatt für synthetische Hartverbände
 Deep saw blade for synthetic casts
 Hoja de sierra de profundidad para vendaje sintéticos rígidos
 Sega a taglio di profondità per bendaggi duri sintetici



48-110-02

Transportkoffer, blau, inklusive Formeinlage für BLUE oder ELEKTRO POWER
 Transport case, blue, including inlay for BLUE or ELECTRO POWER
 Transporte valija, azul, inclusive pieza postiza per BLUE o ELECTRO POWER
 Cargo valigetta, blu, incluso inserto per BLUE o ELECTRO POWER



40-250-25	2,5 mm
40-250-35	3,5 mm



PASSOW

40-250-25 - 40-250-35 12,0 cm, 4 3/4"



40-251-02	Ø 2,0 mm
40-251-03	Ø 3,0 mm
40-251-04	Ø 4,0 mm
40-251-05	Ø 5,0 mm
40-251-06	Ø 6,0 mm
40-251-08	Ø 8,0 mm
40-251-10	Ø 10,0 mm



40-251-02 - 40-251-10 16,0 cm, 6 1/4"



40-252-03	Ø 3,0 mm
40-252-05	Ø 5,0 mm
40-252-08	Ø 8,0 mm
40-252-12	Ø 12,0 mm
40-252-14	Ø 14,0 mm
40-252-16	Ø 16,0 mm



CASPAR

40-252-03 - 40-252-16 20,0 cm, 8"



40-252-03 P	Ø 3,0 mm
40-252-05 P	Ø 5,0 mm
40-252-08 P	Ø 8,0 mm
40-252-12 P	Ø 12,0 mm
40-252-14 P	Ø 14,0 mm
40-252-16 P	Ø 16,0 mm



40-252-03 P - 40-252-16 P 20,0 cm, 8"



4,0 mm
40-254-04
Flachmeißel
Chisel
Cincele
Scalpelli

FREER

40-254-04 17,0 cm, 6 3/4 "



4,0 mm
40-255-04
Flachmeißel
Chisel
Cincele
Scalpelli

FREER

40-255-04 17,0 cm, 6 3/4 "



6,0 mm
40-256-06
Hohlmeißel
Gouge
Gubia
Sgorbie

FREER

40-256-06 15,0 cm, 6 "



4,0 mm
40-258-04
Flachmeißel
Chisel
Cincele
Scalpelli

WEST

40-258-04 16,0 cm, 6 1/4 "



4,0 mm
40-259-04
Hohlmeißel
Gouge
Gubia
Sgorbie

WEST

40-259-04 16,0 cm, 6 1/4 "

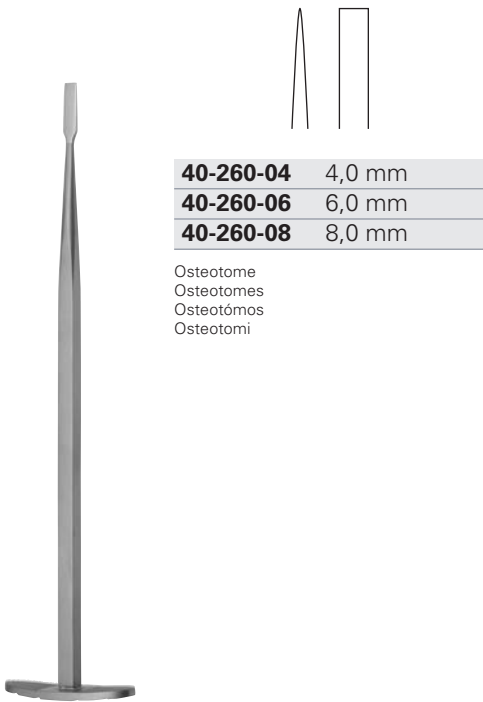

DUNN-DAUTREY

40-260-04 - 40-260-08 16,5 cm, 6 1/2"



DUNN-DAUTREY

40-261-01 17,0 cm, 6 3/4"



DUNN-DAUTREY

40-261-03 17,0 cm, 6 3/4"

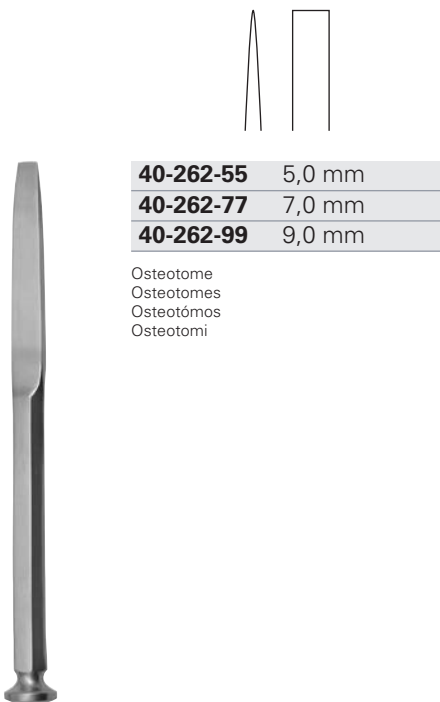

GILLIES

40-262-55 - 40-262-99 14,0 cm, 5 1/2"

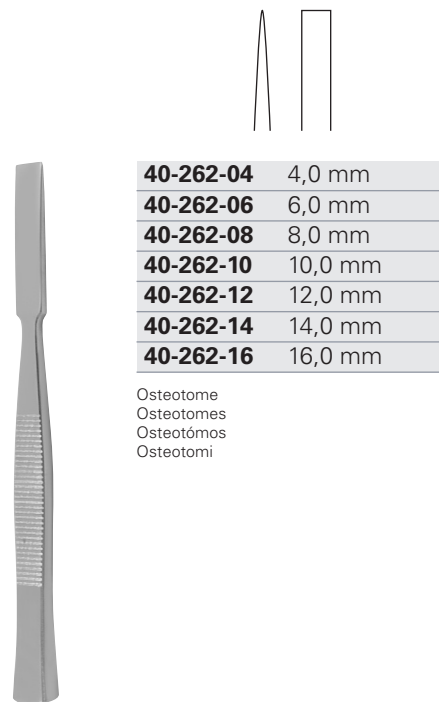

40-262-04 - 40-262-16 14,0 cm, 5 1/2"

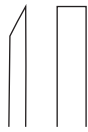

40-263-04	4,0 mm
40-263-06	6,0 mm
40-263-08	8,0 mm
40-263-10	10,0 mm
40-263-12	12,0 mm
40-263-14	14,0 mm
40-263-16	16,0 mm

Flachmeißel
Chisels
Cinceles
Scalpelli

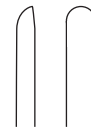

40-264-04	4,0 mm
40-264-06	6,0 mm
40-264-08	8,0 mm
40-264-10	10,0 mm
40-264-12	12,0 mm
40-264-14	14,0 mm
40-264-16	16,0 mm

Hohlmeißel
Gouges
Gubias
Sgorbie

40-263-04 - 40-263-16 14,0 cm, 5 ½"

40-264-04 - 40-264-16 14,0 cm, 5 ½"

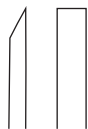

40-265-02	2,0 mm
40-265-03	3,0 mm
40-265-04	4,0 mm
40-265-05	5,0 mm
40-265-06	6,0 mm
40-265-08	8,0 mm
40-265-10	10,0 mm
40-265-12	12,0 mm

Flachmeißel
Chisels
Cinceles
Scalpelli

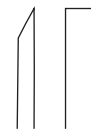

40-266-02	2,0 mm
40-266-03	3,0 mm
40-266-04	4,0 mm
40-266-05	5,0 mm
40-266-06	6,0 mm
40-266-07	7,0 mm
40-266-08	8,0 mm

Flachmeißel
Chisels
Cinceles
Scalpelli

PARTSCH

40-265-02 - 40-265-12 14,0 cm, 5 ½"

PARTSCH

40-266-02 - 40-266-08 17,0 cm, 6 ¾"

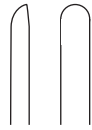

40-267-02	2,0 mm
40-267-03	3,0 mm
40-267-04	4,0 mm
40-267-05	5,0 mm
40-267-06	6,0 mm
40-267-08	8,0 mm
40-267-10	10,0 mm
40-267-12	12,0 mm

Hohlmeißel
Gouges
Gubias
Sgorbie

PARTSCH

40-267-02 - 40-267-12 14,0 cm, 5 1/2"

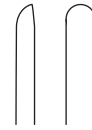

40-268-02	2,0 mm
40-268-03	3,0 mm
40-268-04	4,0 mm
40-268-05	5,0 mm
40-268-06	6,0 mm
40-268-07	7,0 mm
40-268-08	8,0 mm

Hohlmeißel
Gouges
Gubias
Sgorbie

PARTSCH

40-268-02 - 40-268-08 17,0 cm, 6 3/4"



3,4 mm

40-268-34

Meißel
Chisels
Cinceles
Scalpelli



40-268-34 13,5 cm, 5 1/4"



3,4 mm

40-268-35

Meißel
Chisels
Cinceles
Scalpelli



40-268-35 13,5 cm, 5 1/4"

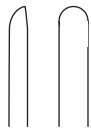

40-269-03	3,0 mm
40-269-05	5,0 mm
40-269-07	7,0 mm
40-269-09	9,0 mm

Hohlmeißel
Gouges
Gubias
Sgorbie



TRAUTMANN

40-269-03 - 40-269-09 14,0 cm, 5 ½"

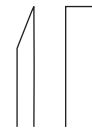

40-270-03	3,0 mm
40-270-05	5,0 mm
40-270-07	7,0 mm
40-270-09	9,0 mm

Flachmeißel
Chisels
Cinceles
Scalpelli



TRAUTMANN

40-270-03 - 40-270-09 14,0 cm, 5 ½"

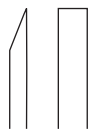

40-271-04	4,0 mm
40-271-06	6,0 mm
40-271-08	8,0 mm
40-271-10	10,0 mm

Flachmeißel
Chisels
Cinceles
Scalpelli



BRUENINGS-LUCAS

40-271-04 - 40-271-10 16,0 cm, 6 ¼"

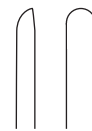

40-272-03	3,0 mm
40-272-05	5,0 mm
40-272-08	8,0 mm
40-272-10	10,0 mm

Hohlmeißel
Gouge
Gubia
Sgorbie



BRUENINGS-LUCAS

40-272-03 - 40-272-10 16,0 cm, 6 ¼"

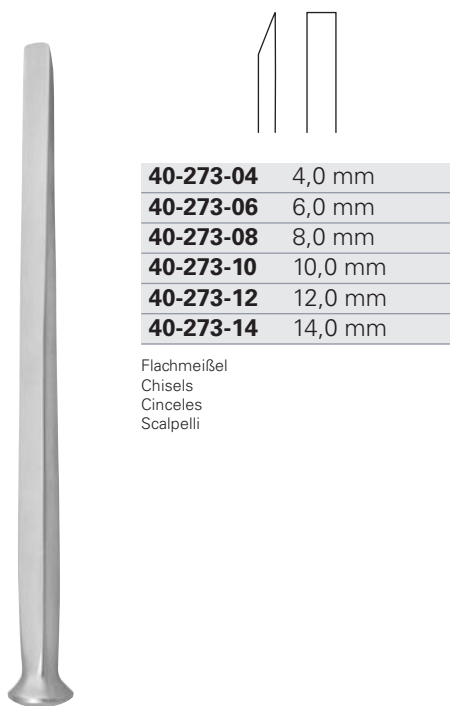

40-273-04	4,0 mm
40-273-06	6,0 mm
40-273-08	8,0 mm
40-273-10	10,0 mm
40-273-12	12,0 mm
40-273-14	14,0 mm

Flachmeißel
Chisels
Cinceles
Scalpelli

ALEXANDER

40-273-04 - 40-273-14 17,5 cm, 7 "

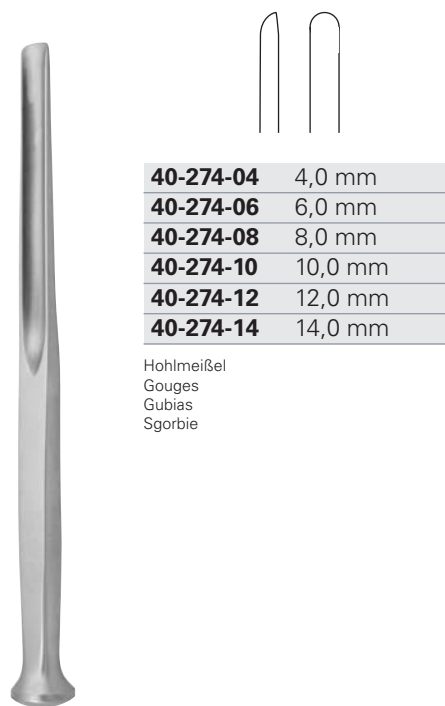

40-274-04	4,0 mm
40-274-06	6,0 mm
40-274-08	8,0 mm
40-274-10	10,0 mm
40-274-12	12,0 mm
40-274-14	14,0 mm

Hohlmeißel
Gouges
Gubias
Sgorbie

ALEXANDER

40-274-04 - 40-274-14 17,5 cm, 7 "

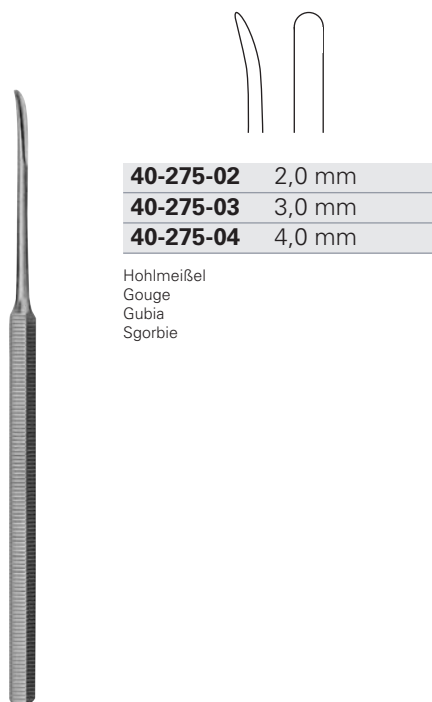

40-275-02	2,0 mm
40-275-03	3,0 mm
40-275-04	4,0 mm

Hohlmeißel
Gouge
Gubia
Sgorbie

40-275-02 - 40-275-04 16,0 cm, 6 ¼ "

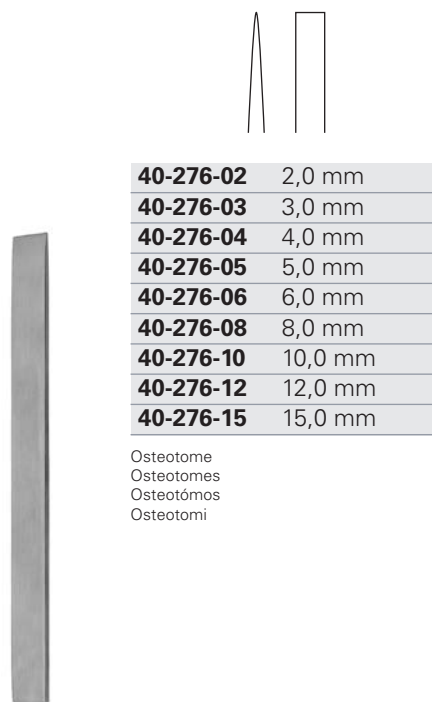

40-276-02	2,0 mm
40-276-03	3,0 mm
40-276-04	4,0 mm
40-276-05	5,0 mm
40-276-06	6,0 mm
40-276-08	8,0 mm
40-276-10	10,0 mm
40-276-12	12,0 mm
40-276-15	15,0 mm

Osteotome
Osteotomes
Osteótomos
Osteotomi

MINI-LAMBOTTE

40-276-02 - 40-276-15 12,5 cm, 5 "

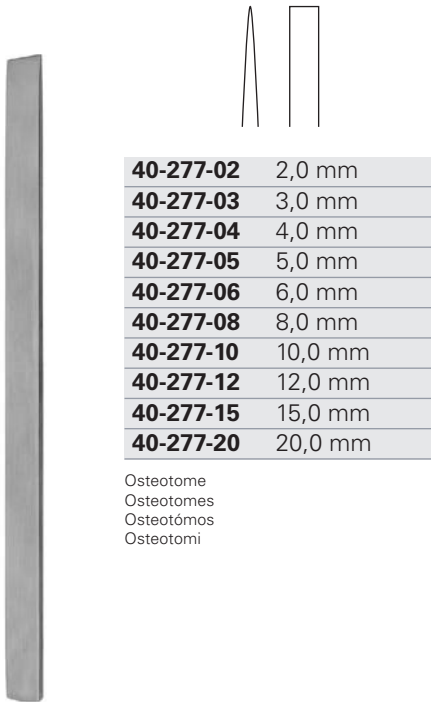

40-277-02	2,0 mm
40-277-03	3,0 mm
40-277-04	4,0 mm
40-277-05	5,0 mm
40-277-06	6,0 mm
40-277-08	8,0 mm
40-277-10	10,0 mm
40-277-12	12,0 mm
40-277-15	15,0 mm
40-277-20	20,0 mm

Osteotome
 Osteotomes
 Osteótomos
 Osteotomi

MINI-LAMBOTTE

40-277-02 - 40-276-20 17,0 cm, 6 ¾ "

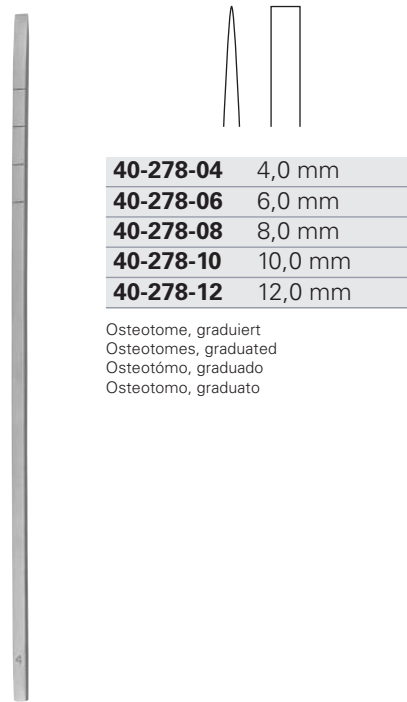

40-278-04	4,0 mm
40-278-06	6,0 mm
40-278-08	8,0 mm
40-278-10	10,0 mm
40-278-12	12,0 mm

Osteotome, graduiert
 Osteotomes, graduated
 Osteótomo, graduado
 Osteotomo, graduato

COTTLE

40-278-04 - 40-278-12 18,0 cm, 7 "

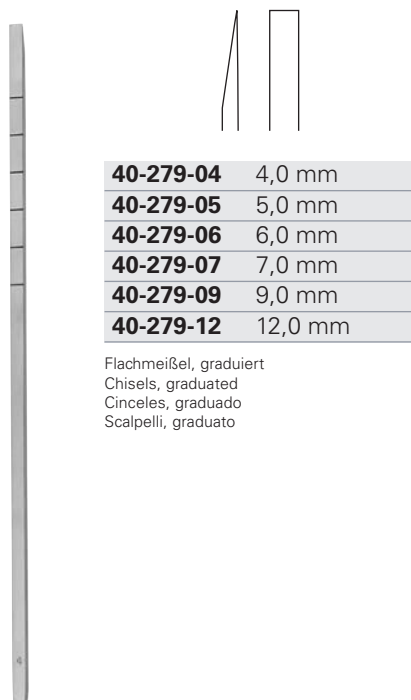

40-279-04	4,0 mm
40-279-05	5,0 mm
40-279-06	6,0 mm
40-279-07	7,0 mm
40-279-09	9,0 mm
40-279-12	12,0 mm

Flachmeißel, graduiert
 Chisels, graduated
 Cinceles, graduado
 Scalpelli, graduato

COTTLE

40-279-04 - 40-279-12 18,0 cm, 7 "

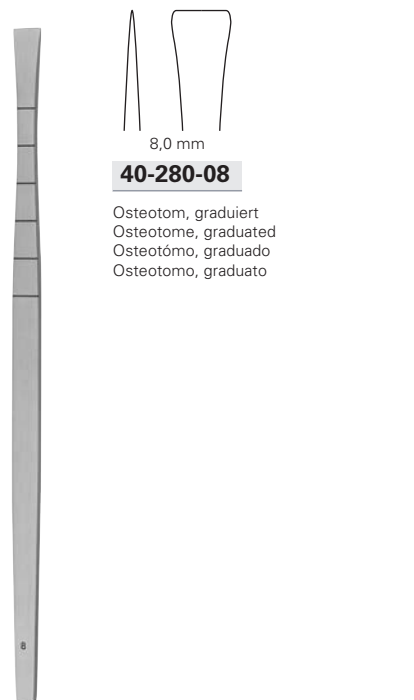

40-280-08

Osteotom, graduiert
 Osteotome, graduated
 Osteótomo, graduado
 Osteotomo, graduato

COTTLE

40-280-08 18,0 cm, 7 "



40-282-08	8,0 mm
40-282-10	10,0 mm
40-282-12	12,0 mm
40-282-15	15,0 mm
40-282-20	20,0 mm
40-282-25	25,0 mm

Flachmeißel
Chisels
Cinceles
Scalpelli

STILLE

40-282-08 - 40-282-25 20,0 cm, 8 "

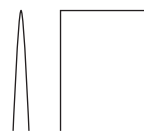

40-286-10	10,0 mm
40-286-12	12,0 mm
40-286-15	15,0 mm
40-286-20	20,0 mm
40-286-25	25,0 mm

Osteotome, fein
Osteotomes, delicate
Osteótomos, fino
Osteotomi, fino

STILLE

40-286-10 - 40-286-25 20,0 cm, 8 "

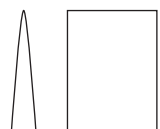

40-284-06	6,0 mm
40-284-08	8,0 mm
40-284-10	10,0 mm
40-284-12	12,0 mm
40-284-15	15,0 mm
40-284-20	20,0 mm
40-284-25	25,0 mm
40-284-30	30,0 mm

Osteotome
Osteotomes
Osteótomos
Osteotomi

STILLE

40-284-06 - 40-285-30 20,0 cm, 8 "

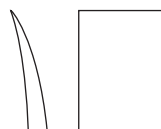

40-285-06	6,0 mm
40-285-08	8,0 mm
40-285-10	10,0 mm
40-285-12	12,0 mm
40-285-15	15,0 mm
40-285-20	20,0 mm
40-285-25	25,0 mm
40-285-30	30,0 mm

Osteotome
Osteotomes
Osteótomos
Osteotomi

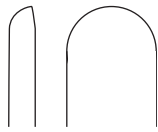

40-288-10	10,0 mm
40-288-12	12,0 mm
40-288-15	15,0 mm
40-288-20	20,0 mm
40-288-25	25,0 mm

Hohlmeißel
 Gouges
 Gubias
 Sgorbie

STILLE

40-288-10 - 40-288-25 20,0 cm, 8 "

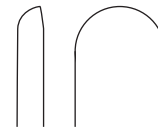

40-289-10	10,0 mm
40-289-15	15,0 mm

Hohlmeißel
 Gouges
 Gubias
 Sgorbie

WALTER

40-289-10 - 40-289-15 20,0 cm, 8 "

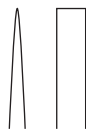

40-290-02	2,0 mm
40-290-03	3,0 mm
40-290-05	5,0 mm
40-290-07	7,0 mm
40-290-10	10,0 mm
40-290-14	14,0 mm
40-290-16	16,0 mm

Osteotome
 Osteotomes
 Osteótomos
 Osteotomi

TESSIER

40-290-02 - 40-290-16 16,0 cm, 6 ¼ "



40-291-05	5,0 mm
40-291-07	7,0 mm
40-291-10	10,0 mm

Osteotome
 Osteotomes
 Osteótomos
 Osteotomi

TESSIER

40-291-05 - 40-291-10 16,0 cm, 6 ¼ "



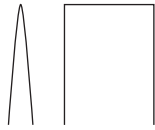

40-292-04	4,0 mm
40-292-06	6,0 mm
40-292-08	8,0 mm
40-292-10	10,0 mm
40-292-13	13,0 mm
40-292-15	15,0 mm
40-292-18	18,0 mm
40-292-20	20,0 mm
40-292-25	25,0 mm
40-292-30	30,0 mm
40-292-38	38,0 mm
40-292-44	44,0 mm
40-292-50	50,0 mm

Osteotome
Osteotomes
Osteótomos
Osteotomi

LAMBOTTE

40-292-04 - 40-292-50 24,0 cm, 9 ½"

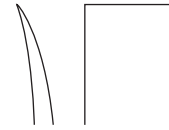

40-293-04	4,0 mm
40-293-06	6,0 mm
40-293-08	8,0 mm
40-293-10	10,0 mm
40-293-13	13,0 mm
40-293-15	15,0 mm
40-293-18	18,0 mm
40-293-20	20,0 mm
40-293-25	25,0 mm
40-293-30	30,0 mm
40-293-38	38,0 mm
40-293-44	44,0 mm
40-293-50	50,0 mm

Osteotome
Osteotomes
Osteótomos
Osteotomi

LAMBOTTE

40-293-04 - 40-293-50 24,0 cm, 9 ½"

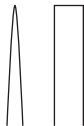

40-294-04	4,0 mm
40-294-06	6,0 mm
40-294-08	8,0 mm
40-294-10	10,0 mm
40-294-12	12,0 mm
40-294-14	14,0 mm
40-294-16	16,0 mm

Osteotome
Osteotomes
Osteótomos
Osteotomi

DAUTREY-MUNRO

40-294-04 - 40-294-16 16,0 cm, 6 ¼"



40-294-74	4,0 mm
40-294-76	6,0 mm
40-294-78	8,0 mm
40-294-80	10,0 mm
40-294-82	12,0 mm
40-294-84	14,0 mm
40-294-86	16,0 mm

Osteotome
Osteotomes
Osteótomos
Osteotomi

DAUTREY-MUNRO

40-294-74 - 40-294-86 16,0 cm, 6 ¼"

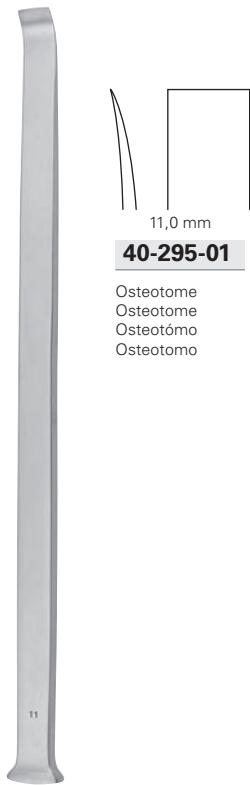

40-295-01

Osteotome
 Osteotome
 Osteótomo
 Osteotomo

OBWEGESER

40-295-01 23,5 cm, 9 ¼"



40-295-08 8,0 mm
40-295-12 12,0 mm
40-295-16 16,0 mm

Keilosteotome
 Wedge osteotomes
 Osteótomos de cuña
 Osteotomi a forma di cuneo



OBWEGESER

40-295-08 - 40-295-16 22,0 cm, 8 ¾"



40-295-21 7,0 mm
40-295-22 10,0 mm

Spaltungsosteotome
 Splitting osteotomes
 Osteótomos hendedores
 Osteotomi fenditori



OBWEGESER

40-295-21 - 40-295-22 22,0 cm, 8 ¾"



40-296-01 8,0 mm
40-296-02 12,0 mm
40-296-03 16,0 mm
40-296-04 20,0 mm

Blattosteotome
 Blade osteotomes
 Osteótomos de hoja
 Osteotomi a forma di lama



OBWEGESER

40-296-01 - 40-296-04 22,0 cm, 8 ¾"

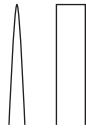

40-295-25	3,0 mm
40-295-40	4,0 mm
40-295-65	6,5 mm

Interdentale Osteotome
Interdental osteotomes
Osteótomos interdentaes
Osteotomi interdentai

OBWEGESER

40-295-25 - 40-295-65 15,0 cm, 6 "



40-297-24	4,0 mm
40-297-26	6,0 mm
40-297-28	8,0 mm

Osteotome, graduiert
Osteotomes, graduated
Osteótomos, graduado
Osteotomi, graduato

OBWEGESER

40-297-24 - 40-297-28 18,5 cm, 7 ¼ "

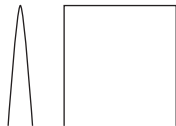

40-296-10	10,0 mm
40-296-15	15,0 mm
40-296-20	20,0 mm
40-296-30	30,0 mm

Osteotome
Osteotomes
Osteótomos
Osteotomi

TESSIER

40-296-10 - 40-296-30 20,0 cm, 8 "

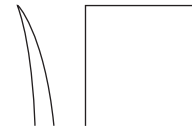

40-297-10	10,0 mm
40-297-15	15,0 mm

Osteotome
Osteotomes
Osteótomos
Osteotomi

TESSIER

40-297-10 - 40-297-15 20,0 cm, 8 "



40-296-11	10,0 mm
40-296-16	15,0 mm

Osteotome
 Osteotomes
 Osteótomos
 Osteotomi

TESSIER

40-296-11 - 40-296-16 16,0 cm, 6 ¼"



40-297-11	10,0 mm
40-297-16	15,0 mm

Osteotome
 Osteotomes
 Osteótomos
 Osteotomi

TESSIER

40-297-11 - 40-297-16 16,0 cm, 6 ¼"

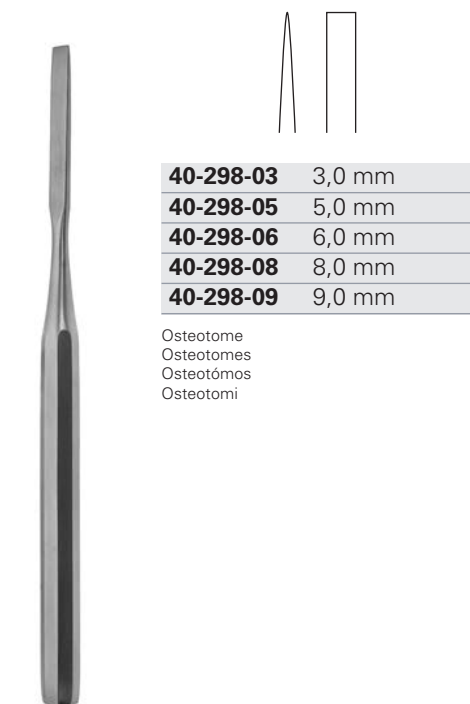

40-298-03	3,0 mm
40-298-05	5,0 mm
40-298-06	6,0 mm
40-298-08	8,0 mm
40-298-09	9,0 mm

Osteotome
 Osteotomes
 Osteótomos
 Osteotomi

HOKE

40-298-03 - 40-298-09 17,0 cm, 6 ¾"

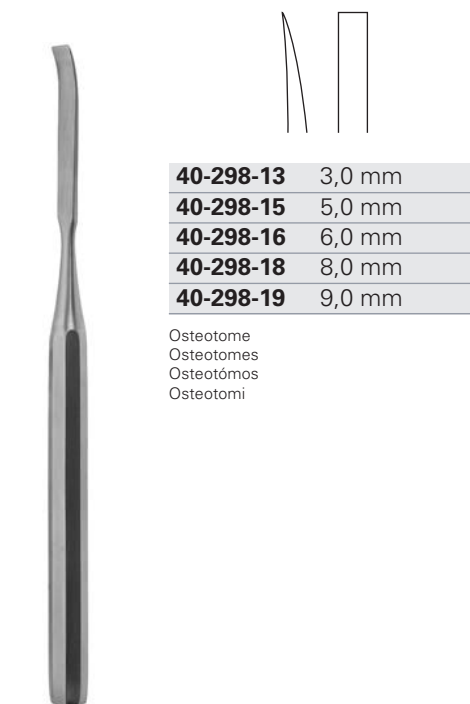

40-298-13	3,0 mm
40-298-15	5,0 mm
40-298-16	6,0 mm
40-298-18	8,0 mm
40-298-19	9,0 mm

Osteotome
 Osteotomes
 Osteótomos
 Osteotomi

HOKE

40-298-13 - 40-298-19 17,0 cm, 6 ¾"

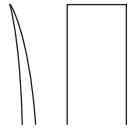

40-299-08	8,0 mm
40-299-10	10,0 mm

Osteotome
Osteotomes
Osteótomos
Osteotomi

NIEDERDELMANN

40-299-08 - 40-299-10 25,0 cm, 9 3/4"

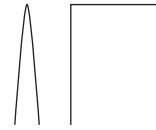

40-300-06	6,0 mm
40-300-09	9,0 mm
40-300-13	13,0 mm
40-300-16	16,0 mm
40-300-19	19,0 mm
40-300-25	25,0 mm
40-300-32	32,0 mm

Osteotome
Osteotomes
Osteótomos
Osteotomi

HIBBS

40-300-06 - 40-300-32 24,5 cm, 9 2/3"

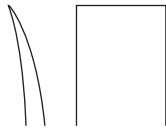

40-301-06	6,0 mm
40-301-13	13,0 mm
40-301-19	19,0 mm
40-301-25	25,0 mm
40-301-32	32,0 mm

Osteotome
Osteotomes
Osteótomos
Osteotomi

HIBBS

40-301-06 - 40-301-32 24,5 cm, 9 2/3"



40-302-06	6,0 mm
40-302-13	13,0 mm
40-302-19	19,0 mm
40-302-25	25,0 mm
40-302-32	32,0 mm

Flachmeißel
Chisels
Cinceles
Scalpelli

HIBBS

40-302-06 - 40-302-32 24,5 cm, 9 2/3"

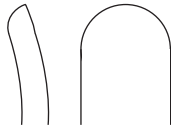

40-303-06	6,0 mm
40-303-13	13,0 mm
40-303-19	19,0 mm
40-303-25	25,0 mm
40-303-32	32,0 mm

Hohlmeißel
 Gouges
 Gubias
 Sgorbie

HIBBS

40-303-06 - 40-303-32 24,5 cm, 9 2/3 "

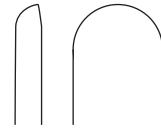

40-304-06	6,0 mm
40-304-13	13,0 mm
40-304-19	19,0 mm
40-304-25	25,0 mm
40-304-32	32,0 mm

Hohlmeißel
 Gouges
 Gubias
 Sgorbie

HIBBS

40-304-06 - 40-304-32 24,5 cm, 9 2/3 "

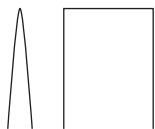

40-306-06	6,0 mm
40-306-09	9,0 mm
40-306-13	13,0 mm
40-306-16	16,0 mm
40-306-19	19,0 mm
40-306-25	25,0 mm
40-306-32	32,0 mm

Osteotome
 Osteotomes
 Osteótomos
 Osteotomi

SMITH-PETERSEN

40-306-06 - 40-306-32 20,5 cm, 8 "

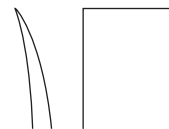

40-307-06	6,0 mm
40-307-09	9,0 mm
40-307-13	13,0 mm
40-307-16	16,0 mm
40-307-19	19,0 mm
40-307-25	25,0 mm
40-307-32	32,0 mm

Osteotome
 Osteotomes
 Osteótomos
 Osteotomi

SMITH-PETERSEN

40-307-06 - 40-307-32 20,5 cm, 8 "

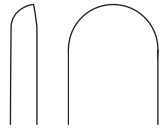

40-308-06	6,0 mm
40-308-09	9,0 mm
40-308-13	13,0 mm
40-308-16	16,0 mm
40-308-19	19,0 mm
40-308-25	25,0 mm
40-308-32	32,0 mm

Hohlmeißel
Gouges
Gubias
Sgorbie

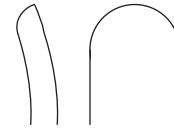

40-309-06	6,0 mm
40-309-09	9,0 mm
40-309-13	13,0 mm
40-309-16	16,0 mm
40-309-19	19,0 mm
40-309-25	25,0 mm
40-309-32	32,0 mm

Hohlmeißel
Gouges
Gubias
Sgorbie

SMITH-PETERSEN

40-308-06 - 40-308-32 20,5 cm, 8 "

SMITH-PETERSEN

40-309-06 - 40-309-32 20,5 cm, 8 "



40-310-80

Schlüssel
Key
Llave
Chiave

Handgriff mit Schlüssel
Handle with key
Mango con llave
Manico con chiave

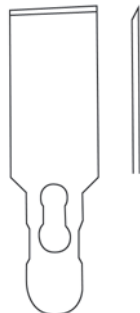

Flachmeißel
Chisel
Cincele
Scalpelli

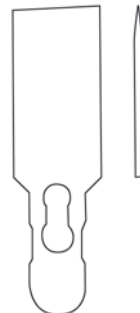

Osteotome
Osteotomes
Osteótomos
Osteotomi

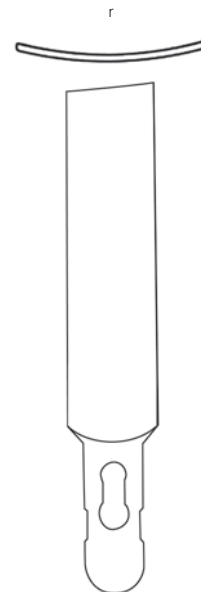

Hohlmeißel
Gouge
Gubia
Sgorbie



40-310-00 18,5 cm, 7 1/4 "

40-310-01	5,0 mm
40-310-02	10,0 mm
40-310-03	16,0 mm
40-310-04	25,0 mm

40-310-05	5,0 mm
40-310-06	10,0 mm
40-310-07	16,0 mm
40-310-08	25,0 mm

40-310-09	r = 50,0 mm
40-310-10	r = 60,0 mm
40-310-11	r = 70,0 mm

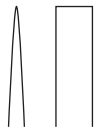

40-316-04	4,0 mm
40-316-06	6,0 mm
40-316-08	8,0 mm
40-316-10	10,0 mm
40-316-12	12,0 mm
40-316-15	15,0 mm

Osteotome
 Osteotomes
 Osteótomos
 Osteotomi



LEXER-MINI

40-316-04 - 40-316-15 18,5 cm, 7 ¼"

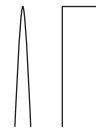

40-316-04 P	4,0 mm
40-316-06 P	6,0 mm
40-316-08 P	8,0 mm
40-316-10 P	10,0 mm
40-316-12 P	12,0 mm

Osteotome
 Osteotomes
 Osteótomos
 Osteotomi



LEXER-MINI

40-316-04 P - 40-316-12 P 18,5 cm, 7 ¼"

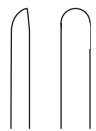

40-318-04	4,0 mm
40-318-06	6,0 mm
40-318-08	8,0 mm
40-318-10	10,0 mm
40-318-12	12,0 mm

Hohlmeißel
 Gouges
 Gubias
 Sgorbie



LEXER-MINI

40-318-04 - 40-318-12 18,5 cm, 7 ¼"

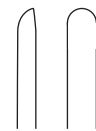

40-318-04 P	4,0 mm
40-318-06 P	6,0 mm
40-318-08 P	8,0 mm
40-318-10 P	10,0 mm
40-318-12 P	12,0 mm

Hohlmeißel
 Gouges
 Gubias
 Sgorbie



LEXER-MINI

40-318-04 P - 40-318-12 P 18,5 cm, 7 ¼"



40-320-01	10,0 mm
40-320-02	15,0 mm
40-320-03	20,0 mm

Flachmeißel
Chisels
Cinceles
Scalpelli



LEXER

40-320-01 - 40-320-03 20,0 cm, 8 "



40-320-01 P	10,0 mm
40-320-02 P	15,0 mm
40-320-03 P	20,0 mm

Flachmeißel
Chisels
Cinceles
Scalpelli



LEXER

40-320-01 P - 40-320-03 P 20,0 cm, 8 "

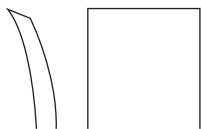

40-321-01	10,0 mm
40-321-02	15,0 mm
40-321-03	20,0 mm

Flachmeißel
Chisels
Cinceles
Scalpelli



LEXER

40-321-01 - 40-321-03 20,0 cm, 8 "

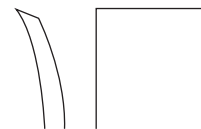

40-321-01 P	10,0 mm
40-321-02 P	15,0 mm
40-321-03 P	20,0 mm

Flachmeißel
Chisels
Cinceles
Scalpelli



LEXER

40-321-01 P - 40-321-03 P 20,0 cm, 8 "

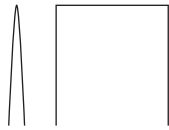

40-320-05	5,0 mm
40-320-07	7,0 mm
40-320-10	10,0 mm
40-320-12	12,0 mm
40-320-15	15,0 mm
40-320-20	20,0 mm
40-320-25	25,0 mm
40-320-30	30,0 mm

Osteotome
 Osteotomes
 Osteótomos
 Osteotomi



LEXER

40-320-05 - 40-320-30 22,0 cm, 8 3/4 "

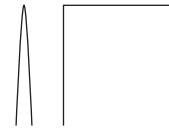

40-320-05 P	5,0 mm
40-320-07 P	7,0 mm
40-320-10 P	10,0 mm
40-320-12 P	12,0 mm
40-320-15 P	15,0 mm
40-320-20 P	20,0 mm
40-320-25 P	25,0 mm
40-320-30 P	30,0 mm

Osteotome
 Osteotomes
 Osteótomos
 Osteotomi



LEXER

40-320-05 P - 40-320-30 P 22,0 cm, 8 3/4 "

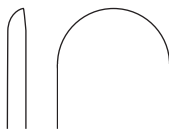

40-322-05	5,0 mm
40-322-07	7,0 mm
40-322-10	10,0 mm
40-322-12	12,0 mm
40-322-15	15,0 mm
40-322-20	20,0 mm
40-322-25	25,0 mm
40-322-30	30,0 mm

Hohlmeißel
 Gouges
 Gubias
 Sgorbie



LEXER

40-322-05 - 40-322-30 22,0 cm, 8 3/4 "

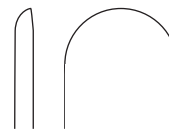

40-322-05 P	5,0 mm
40-322-07 P	7,0 mm
40-322-10 P	10,0 mm
40-322-12 P	12,0 mm
40-322-15 P	15,0 mm
40-322-20 P	20,0 mm
40-322-25 P	25,0 mm
40-322-30 P	30,0 mm

Hohlmeißel
 Gouges
 Gubias
 Sgorbie



LEXER

40-322-05 P - 40-322-30 P 22,0 cm, 8 3/4 "



40-324-09

Hohlmeißel zum Freilegen
abgebrochener Schrauben

Gouge for removing of
broken screws

Gubia para exteriorizar
tornillos truncados

Sgorbie per rimuovere
viti rotte



LEXER

40-324-09 22,0 cm, 8 3/4"



40-324-09 P

Hohlmeißel zum Freilegen
abgebrochener Schrauben

Gouge for removing of
broken screws

Gubia para exteriorizar
tornillos truncados

Sgorbie per rimuovere
viti rotte



LEXER

40-324-09 P 22,0 cm, 8 3/4"

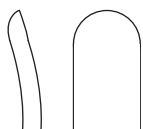

40-325-55 5,5 mm

40-325-90 9,0 mm

Hohlmeißel für Skoliose Operationen
Gouges for scoliosis operations
Gubias para operaciones scoliosis
Sgorbie per interventi di scoliosi



ZIELKE

40-325-55 - 40-325-90 23,0 cm, 9"



40-325-55 P 5,5 mm

40-325-90 P 9,0 mm

Hohlmeißel für Skoliose Operationen
Gouges for scoliosis operations
Gubias para operaciones scoliosis
Sgorbie per interventi di scoliosi



ZIELKE

40-325-55 P - 40-325-90 P 23,0 cm, 9"

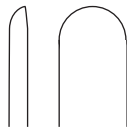

40-326-05	5,0 mm
40-326-10	10,0 mm
40-326-15	15,0 mm

Spongiosa Hohlmeißel
Spongiosa gouges
Gubias de esponjosa
Sgorbie per tessuto osseo spugnoso



LEXER

40-326-05 - 40-326-15 25,0 cm, 9 3/4 "

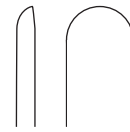

40-326-05 P	5,0 mm
40-326-10 P	10,0 mm
40-326-15 P	15,0 mm

Spongiosa Hohlmeißel
Spongiosa gouges
Gubias de esponjosa
Sgorbie per tessuto osseo spugnoso



LEXER

40-326-05 P - 40-326-15 P 25,0 cm, 9 3/4 "



40-327-05	5,0 mm
40-327-10	10,0 mm
40-327-15	15,0 mm

Spongiosa Hohlmeißel
Spongiosa gouges
Gubias de esponjosa
Sgorbie per tessuto osseo spugnoso



LEXER

40-327-05 - 40-327-15 25,0 cm, 9 3/4 "

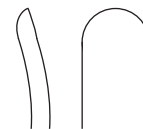

40-327-05 P	5,0 mm
40-327-10 P	10,0 mm
40-327-15 P	15,0 mm

Spongiosa Hohlmeißel
Spongiosa gouges
Gubias de esponjosa
Sgorbie per tessuto osseo spugnoso



LEXER

40-327-05 P - 40-327-15 P 25,0 cm, 9 3/4 "



40-328-20 24,5 cm, 9 3/4 "

40-328-20 P 22,0 cm, 8 3/4 "

40-329-16 26,5 cm, 10 1/2 "

40-329-16 P 26,5 cm, 10 1/2 "



15,0 mm
40-330-15
 Osteotom
 Osteotome
 Osteótomo
 Osteotomi



LEXER

40-330-15 27,5 cm, 10 3/4"



15,0 mm
40-330-15 P
 Osteotom
 Osteotome
 Osteótomo
 Osteotomi



LEXER

40-330-15 P 27,5 cm, 10 3/4"



10,0 mm
40-331-10
 15,0 mm
40-331-15
 Osteotome
 Osteotomes
 Osteótomo
 Osteotomi



LEXER

40-331-10 27,5 cm, 10 3/4"
40-331-15 27,5 cm, 10 3/4"



10,0 mm
40-331-10 P
 15,0 mm
40-331-15 P
 Osteotome
 Osteotomes
 Osteótomo
 Osteotomi



LEXER

40-331-10 P 27,5 cm, 10 3/4"
40-331-15 P 27,5 cm, 10 3/4"



10,0 mm

40-333-10

15,0 mm

40-333-15

Hohlmeißel
Gouges
Gubias
Sgorbie



LEXER

40-333-10 27,5 cm, 10 3/4"
40-333-15 27,5 cm, 10 3/4"



10,0 mm

40-333-10 P

15,0 mm

40-333-15 P

Hohlmeißel
Gouges
Gubias
Sgorbie



LEXER

40-333-10 P 27,5 cm, 10 3/4"
40-333-15 P 27,5 cm, 10 3/4"

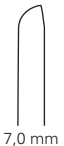

7,0 mm

40-334-07

10,0 mm

40-334-10

Spongiosa
Hohlmeißel
Spongiosa Gouges
Gubias de esponjosa
Sgorbie per tessuto
osseo spungoso



LEXER

40-334-07 27,5 cm, 10 3/4"
40-334-10 27,5 cm, 10 3/4"

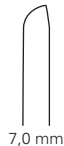

7,0 mm

40-334-07 P

10,0 mm

40-334-10 P

Spongiosa
Hohlmeißel
Spongiosa Gouges
Gubias de esponjosa
Sgorbie per tessuto
osseo spungoso



LEXER

40-334-07 P 27,5 cm, 10 3/4"
40-334-10 P 27,5 cm, 10 3/4"

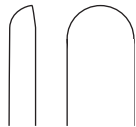

40-336-09	9,0 mm
40-336-15	10,0 mm
40-336-30	30,0 mm

Hohlmeißel
Gouges
Gubias
Sgorbie

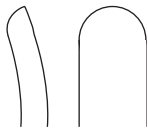

40-337-09	9,0 mm
40-337-15	10,0 mm
40-337-30	30,0 mm

Hohlmeißel
Gouges
Gubias
Sgorbie

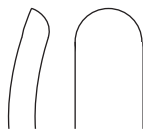

40-339-09	9,0 mm
40-339-15	10,0 mm
40-339-30	30,0 mm

Hohlmeißel
Gouges
Gubias
Sgorbie



WAGNER

40-336-09 - 40-339-30 34,0 cm, 13 1/2 "



40-340-01

Meißel
Chisel
Cinceles
Scalpelli

BRUNETTI

40-340-01 28,0 cm, 11 "



40-340-02

Meißel
Chisel
Cinceles
Scalpelli

BRUNETTI

40-340-02 28,0 cm, 11 "

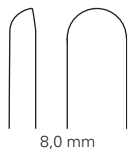

8,0 mm
40-341-01

Spinal Hohlmeißel
Spinal gouge
Gubia espinal
Sgorbie spinali



COBB

40-341-01 27,0 cm, 10 3/4"

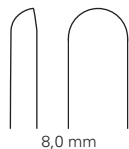

8,0 mm
40-341-02

Spinal Hohlmeißel
Spinal gouge
Gubia espinal
Sgorbie spinali



COBB

40-341-02 27,0 cm, 10 3/4"

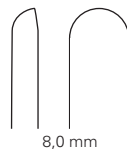

8,0 mm
40-341-03

Spinal Hohlmeißel
Spinal gouge
Gubia espinal
Sgorbie spinali



COBB

40-341-03 27,0 cm, 10 3/4"

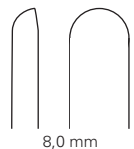

8,0 mm
40-341-04

Spinal Hohlmeißel
Spinal gouge
Gubia espinal
Sgorbie spinali



COBB

40-341-04 27,0 cm, 10 3/4"

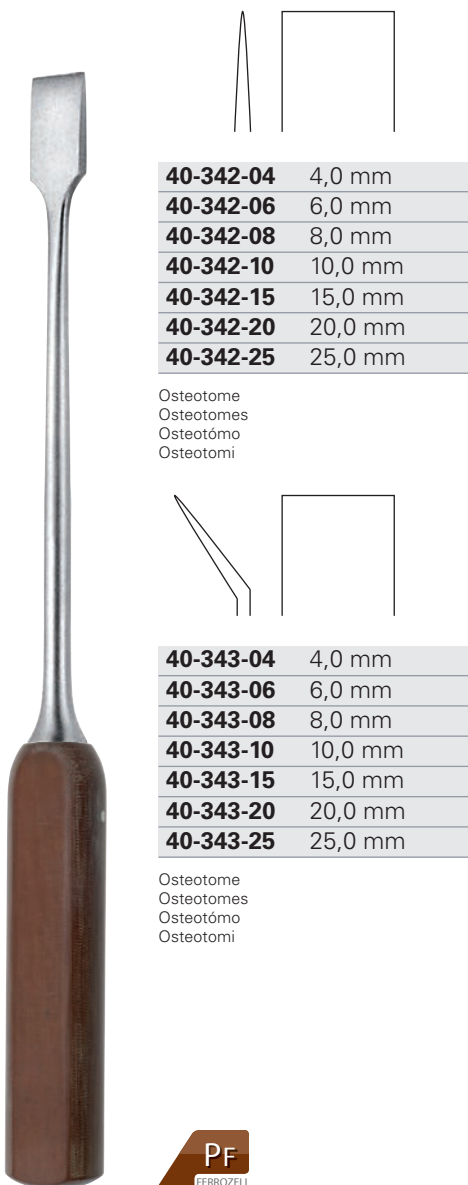

DAHMEN

40-342-04 - 40-343-25 30,0 cm, 11 3/4"

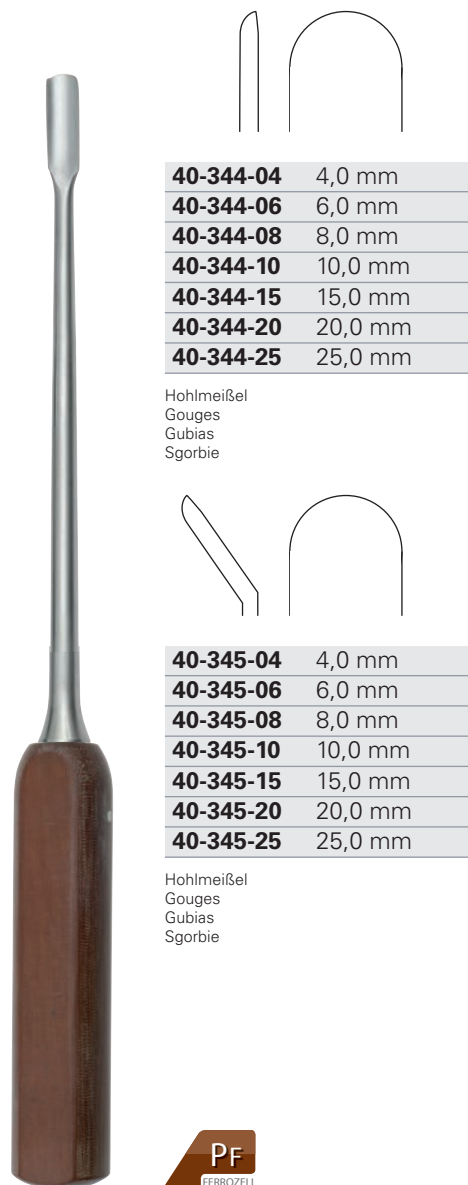

DAHMEN

40-344-04 - 40-345-25 30,0 cm, 11 3/4"

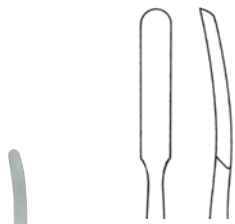

40-348-01

Elevator
Elevator
Elevator
Elevatori



Griff aus Titanium
Titanium handle
Mango de titanio
Manico di titanio



VICKERS

40-348-01 17,0 cm, 6 3/4"



40-348-02

Dissektor
Dissector
Dissectore
Dissettori



Griff aus Titanium
Titanium handle
Mango de titanio
Manico di titanio



VICKERS

40-348-02 17,0 cm, 6 3/4"



40-349-20

Raspatorium
Raspatory
Periostótomo
Periostotomi



6,0 mm

SEWALL

40-349-20 20,0 cm, 8"

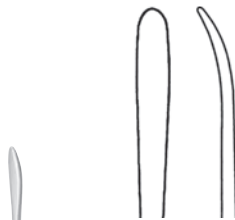

40-350-17

Elevator
Elevator
Elevator
Elevatori



40-350-17 17,0 cm, 6 3/4"



40-351-14

Raspatorium
Raspatory
Periostótomo
Periostotomi



4,0 mm

PARTSCH-LANGE

40-351-14 14,5 cm, 5 3/4"



40-353-01

Elevator
Elevator
Elevator
Elevatori



4,5 mm

KOENIG

40-353-01 - 40-353-02 15,5 cm, 6 1/8"



40-353-02

Elevator
Elevator
Elevator
Elevatori

4,5 mm

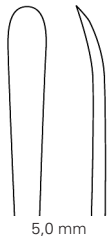

5,0 mm

40-353-15

Raspatorium
Raspatory
Periostótomos
Periostotomi



KOENIG

40-353-15 15,5 cm, 6 1/8"



8,0 mm

40-354-15

Raspatorium
Raspatory
Periostótomos
Periostotomi



TRELAT

40-354-15 15,0 cm, 6"

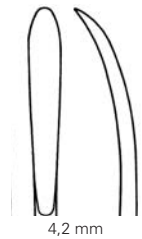

4,2 mm

40-355-14

Raspatorium
Raspatory
Periostótomos
Periostotomi



WILLIGER

40-355-14 13,0 cm, 5 1/8"



3,0 mm

40-355-15

Raspatorium
Raspatory
Periostótomos
Periostotomi



6,0 mm

40-355-16

Raspatorium
Raspatory
Periostótomos
Periostotomi



8,0 mm

40-355-17

Raspatorium
Raspatory
Periostótomos
Periostotomi



WILLIGER

40-355-15 - 40-355-17 16,0 cm, 6 1/4"



4,0 mm

40-356-17

Raspatorium
Raspatory
Periostótomos
Periostotomi



JOSEPH

40-356-17 17,0 cm, 6 3/4"

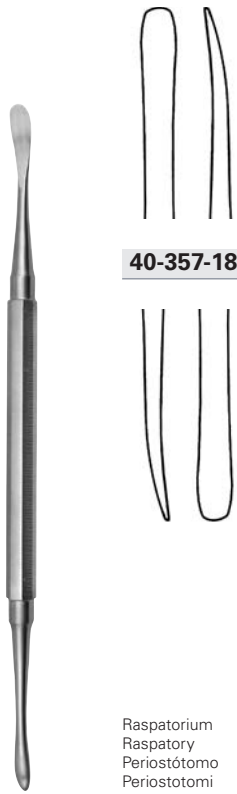

40-357-18

Raspatorium
Raspatory
Periostótomo
Periostotomi

MOLT

40-357-18 18,0 cm, 7"



6,0 mm

40-358-19

stumpf
blunt
romo
smusso

Elevator
Elevator
Elevator
Elevatori

FREER

40-358-19 19,0 cm, 7 1/2"

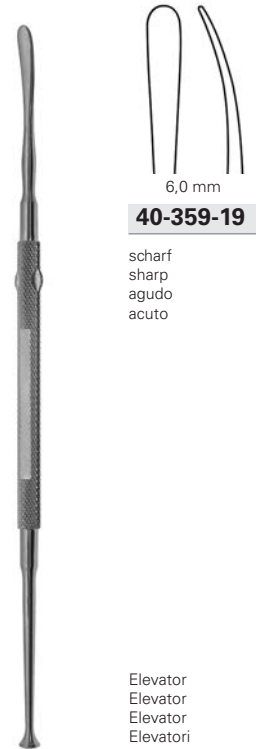

6,0 mm

40-359-19

scharf
sharp
agudo
acuto

Elevator
Elevator
Elevator
Elevatori

FREER

40-359-19 19,0 cm, 7 1/2"



3,2 mm

40-361-16

Raspatorium
Raspatory
Periostótomo
Periostotomi

WULLSTEIN

40-361-16 16,0 cm, 6 1/4"



2,2 mm

40-361-17

Raspatorium
Raspatory
Periostótomo
Periostotomi

WULLSTEIN

40-361-17 16,0 cm, 6 1/4"



7,0 mm

40-362-16

Raspatorium
Raspatory
Periostótomo
Periostotomi

LEMPERT

40-362-16 16,0 cm, 6 1/4"



3,0 mm

40-362-19

Raspatorium
Raspatory
Periostótomo
Periostotomi

LEMPERT

40-362-19 16,0 cm, 6 1/4"

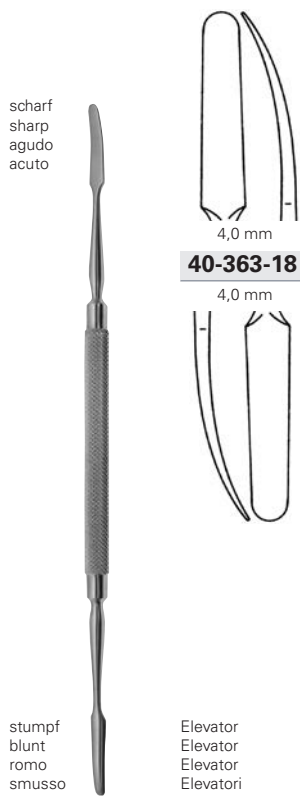

KILLIAN

40-363-18 18,0 cm, 7 "

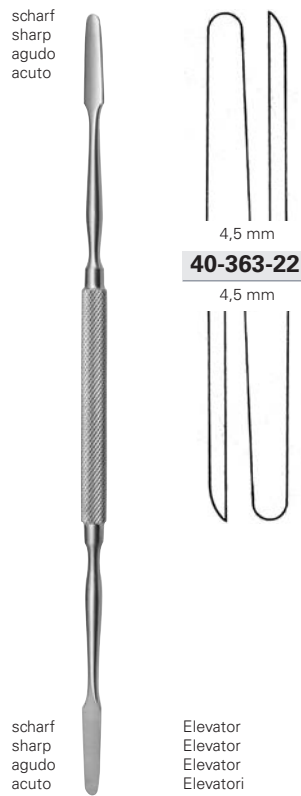

KILLIAN

40-363-22 22,0 cm, 8 3/4 "

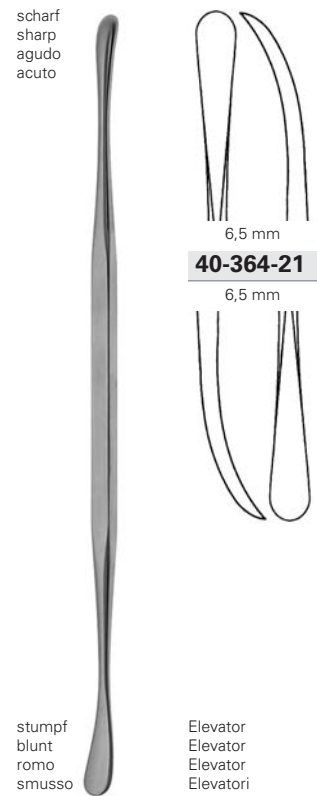

ADLERDYCE

40-364-21 21,0 cm, 8 1/4 "

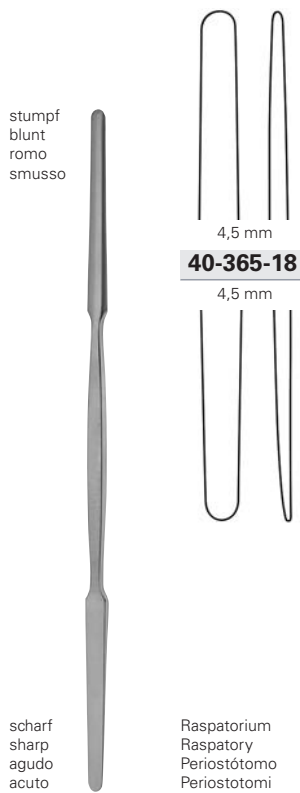

KILLIAN

40-365-18 18,0 cm, 7 "

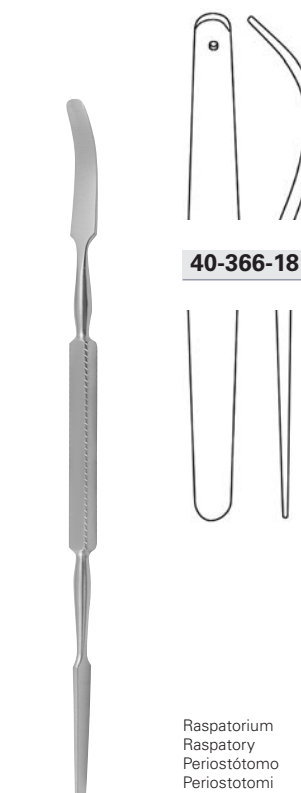

MC DONALD

40-366-18 18,5 cm, 7 1/4 "

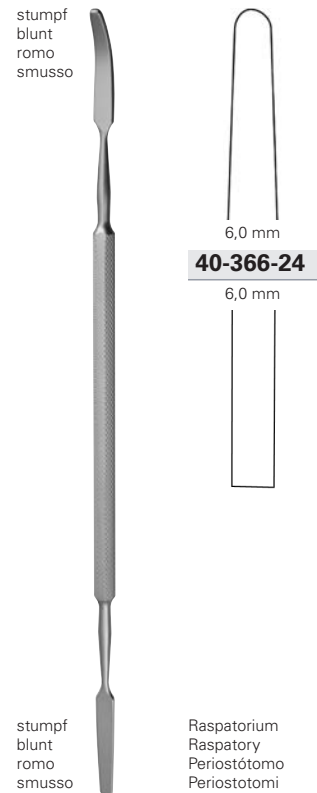

COHEN

40-366-24 24,0 cm, 9 1/2 "

stumpf
blunt
romo
smusso

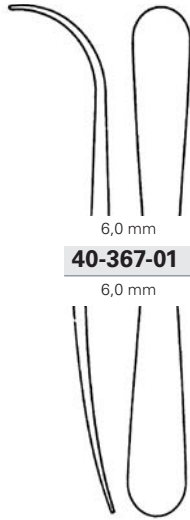

40-367-01

6,0 mm

6,0 mm

stumpf
blunt
romo
smusso

Elevator
Elevator
Elevator
Elevatori

OBWEGESER

40-367-01 21,0 cm, 8 ¼"

stumpf
blunt
romo
smusso

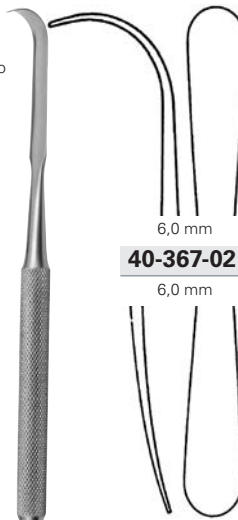

40-367-02

6,0 mm

6,0 mm

scharf
sharp
agudo
acuto

Elevator
Elevator
Elevator
Elevatori

OBWEGESER

40-367-02 21,0 cm, 8 ¼"

2,0 mm

40-371-13

2,5 mm



Dissektor
Dissector
Disectore
Dissettori

WATSON-CHEYNE

40-371-13 13,0 cm, 5 ⅛"

2,0 mm

40-371-19

2,7 mm



Dissektor
Dissector
Disectore
Dissettori

WATSON-CHEYNE

40-371-19 19,0 cm, 7 ½"

9,5 mm

40-372-17

10,5 mm



Dissektor
Dissector
Disectore
Dissettori

WATSON-CHEYNE

40-372-17 17,0 cm, 6 ¾"



40-369-18

Unterkieferkörperhaken
 Mandibular body retractor
 Separador para el cuerpo mandibular
 Separatore per il corpo mandibulare

HARGIS

40-369-18 18,0 cm, 7"



40-369-19

Vorderrandstripper
 Anterior border stripper
 Separador para el borde anterior
 Separatore per il bordo anteriore

HARGIS

40-369-19 19,0 cm, 7 1/2"

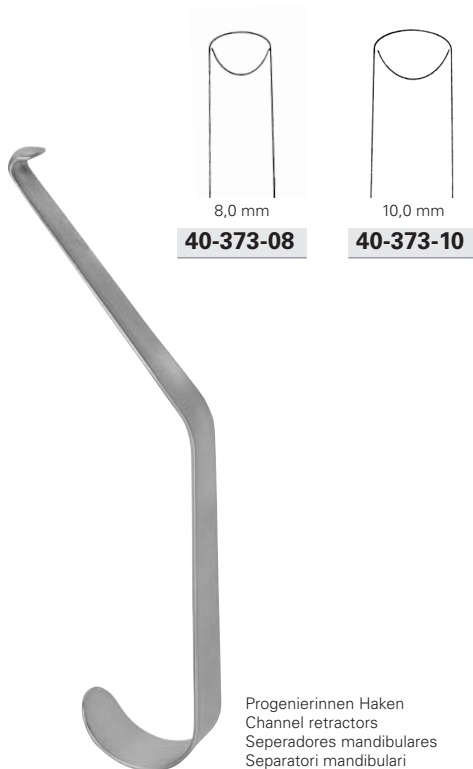

40-373-08

8,0 mm

40-373-10

10,0 mm

Progenierinnen Haken
 Channel retractors
 Separadores mandibulares
 Separatori mandibulari

OBWEGESER

40-373-08 - 40-373-10 16,5 cm, 6 1/2"



OBWEGESER

40-373-16 16,5 cm, 6 1/2"

Kinnhalter
 Chin retractor
 Gancho de mentón
 Guancio per mento



40-374-01

OBWEGESER

40-374-01 17,5 cm, 7 "



40-374-02

OBWEGESER

40-374-02 17,5 cm, 7 "

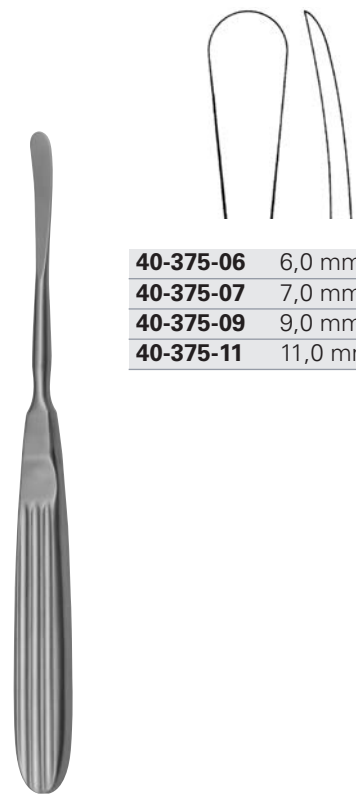

40-375-06	6,0 mm
40-375-07	7,0 mm
40-375-09	9,0 mm
40-375-11	11,0 mm

OBWEGESER

40-375-06 - 40-375-11 17,5 cm, 7 "



40-376-01

TESSIER

40-376-01 18,5 cm, 7 ¼ "



40-376-02

TESSIER

40-376-02 18,5 cm, 7 ¼ "

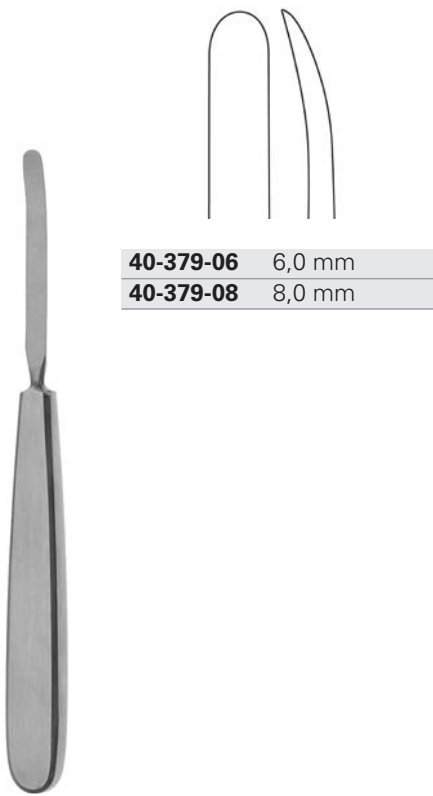

40-379-06 6,0 mm
40-379-08 8,0 mm

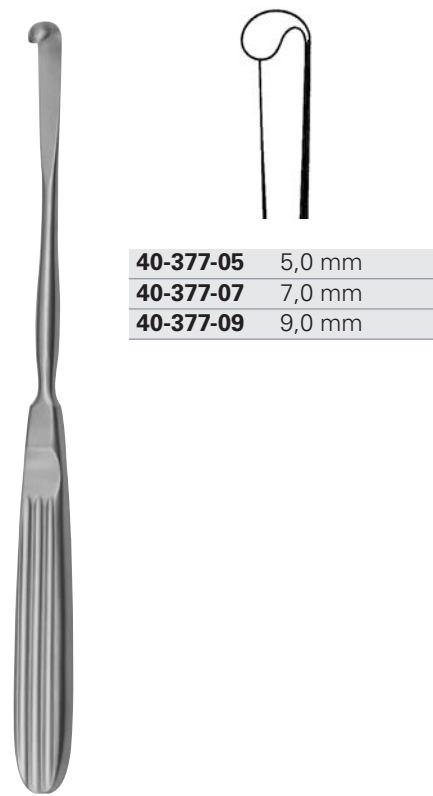

40-377-05 5,0 mm
40-377-07 7,0 mm
40-377-09 9,0 mm

OBWEGESER

40-379-06 - 40-379-08 17,0 cm, 6 3/4 "

40-377-05 - 40-377-09 20,5 cm, 8 "

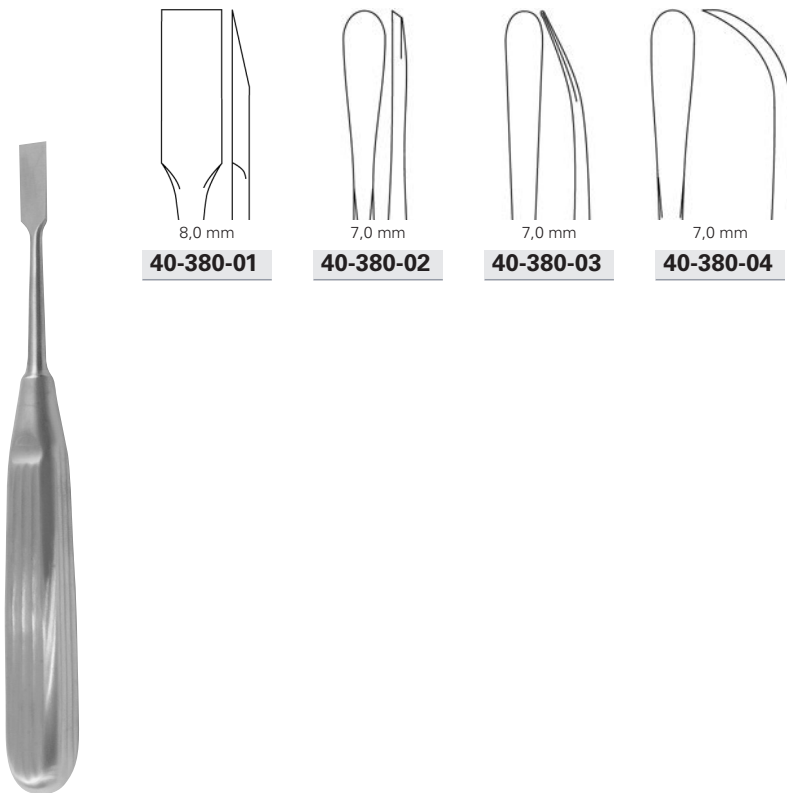

40-380-01 8,0 mm

40-380-02 7,0 mm

40-380-03 7,0 mm

40-380-04 7,0 mm

ADSON

40-380-01 - 40-380-04 17,0 cm, 6 3/4 "



40-381-19

SEWALL

40-381-19 19,0 cm, 7 1/2"



40-382-19

COTTLE

40-382-19 19,0 cm, 7 1/2"



40-383-09

JANSEN

40-383-09 19,5 cm, 7 3/4"



40-383-14

JANSEN

40-383-14 19,5 cm, 7 3/4"



40-385-03 3,0 mm

40-385-06 6,0 mm

40-385-03 - 40-385-06 17,0 cm, 6 3/4"

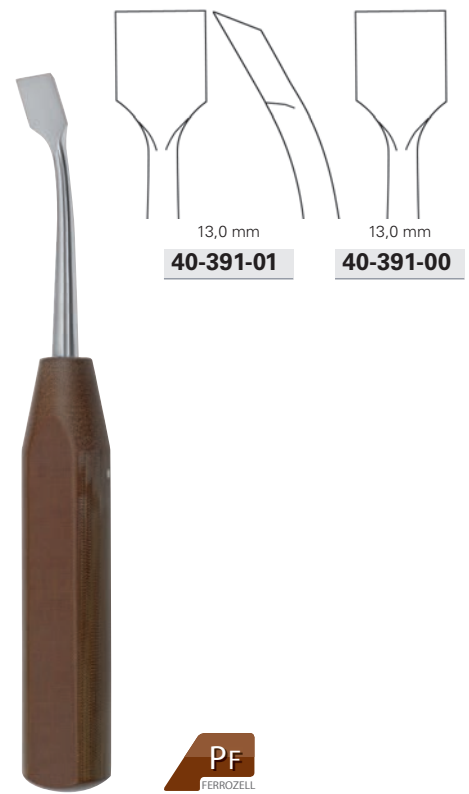
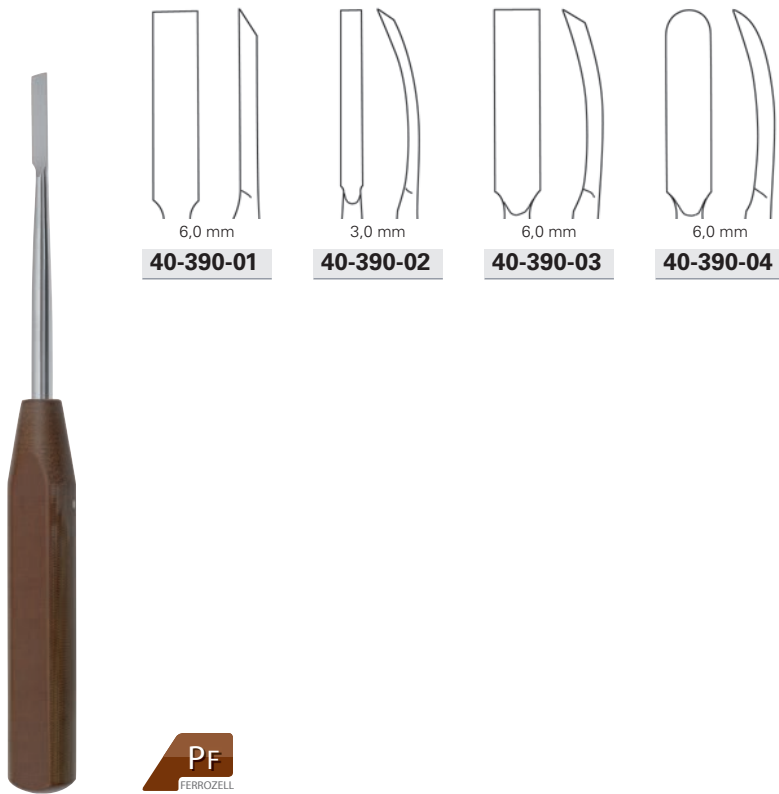

40-390-01 - 40-390-04 19,0 cm, 7 ½"

40-391-00 - 40-391-01 19,0 cm, 7 ½"

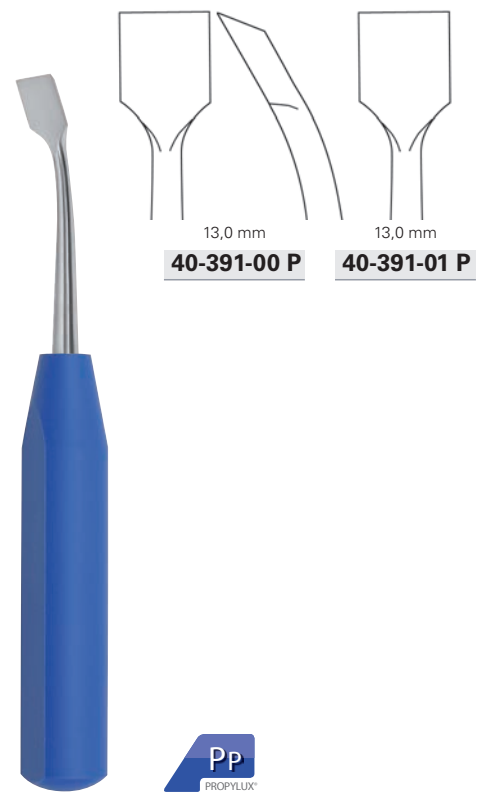
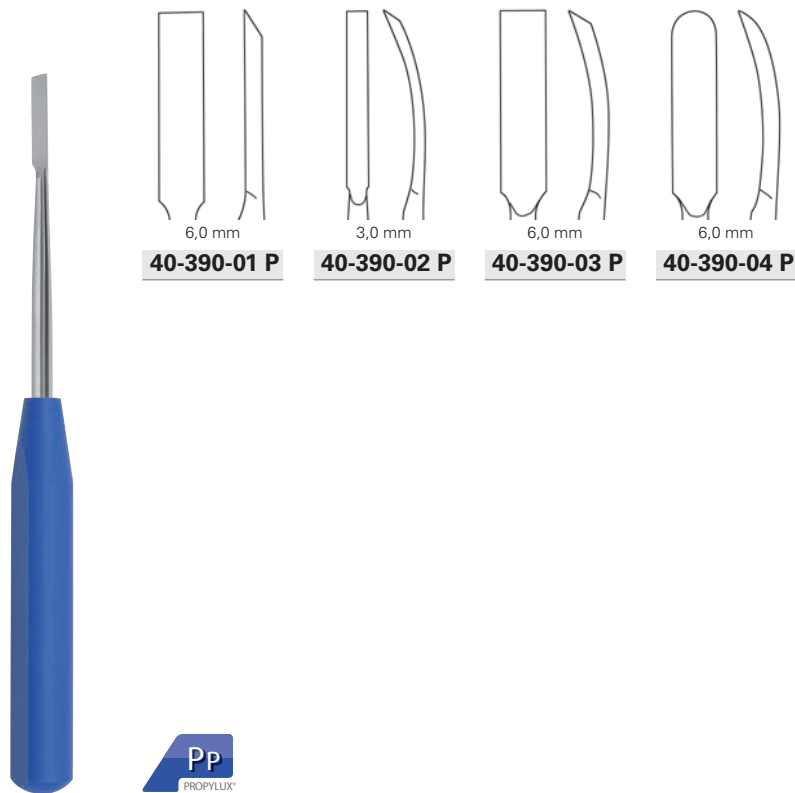

40-390-01 P - 40-390-04 P 19,0 cm, 7 ½"

40-391-00 P - 40-391-01 P 23,0 cm, 9"

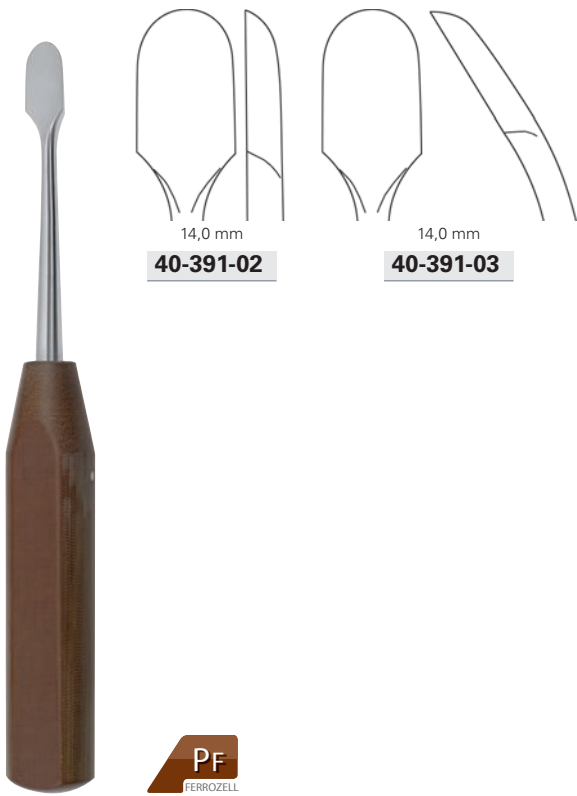

40-391-02 - 40-391-03 20,0 cm, 8 "

40-391-04 20,5 cm, 8 "

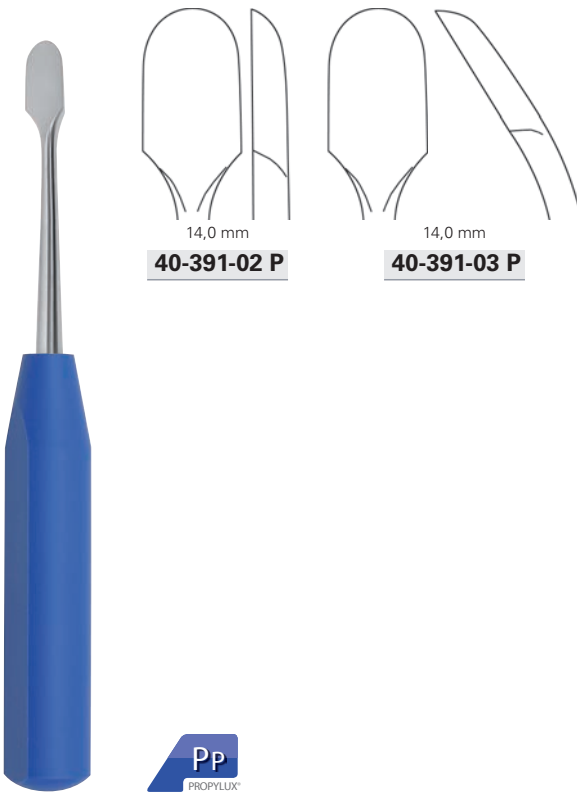

40-391-02 P - 40-391-03 P 19,0 cm, 7 ½ "

40-391-04 P 20,5 cm, 8 "



12,5 mm
40-392-14

FARABEUF

40-392-14 15,0 cm, 6 "



12,5 mm
40-393-14

FARABEUF

40-393-14 15,0 cm, 6 "



11,0 mm
40-394-16

FARABEUF-COLLIN

40-394-16 16,0 cm, 6 3/4 "



11,0 mm
40-395-16

FARABEUF-COLLIN

40-395-16 16,0 cm, 6 3/4 "



18,0 mm
40-396-18

SEDILLOT

40-396-18 18,5 cm, 7 1/4 "



10,0 mm
40-397-01

KRAEMER

40-397-01 18,5 cm, 7 1/4 "



10,0 mm
40-397-02

KRAEMER

40-397-02 19,0 cm, 7 1/2 "



9,5 mm
40-398-19

BUECHS

40-398-19 19,0 cm, 7 1/2 "

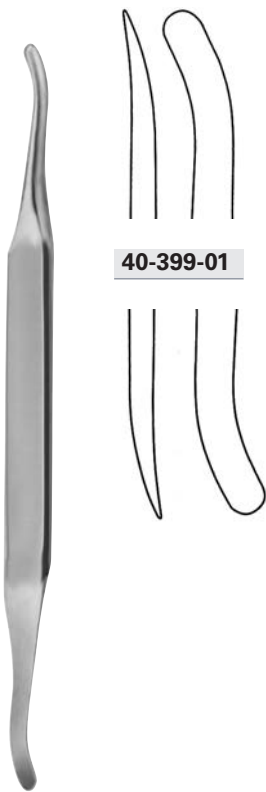

40-399-01

SELDIN

40-399-01 19,5 cm, 7 3/4"

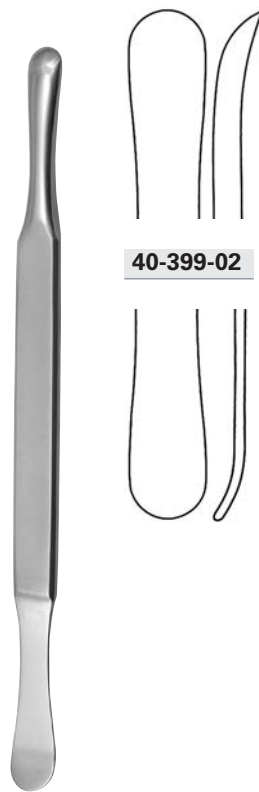

40-399-02

SELDIN

40-399-02 19,5 cm, 7 3/4"



40-400-16

JANSEN

40-400-16 16,5 cm, 6 1/2"



40-401-01

LANGENBECK

40-401-01 18,0 cm, 7"



40-401-02

LANGENBECK

40-401-02 19,0 cm, 7 1/2"



40-402-01

SCHNEIDER

40-402-01 17,5 cm, 7"

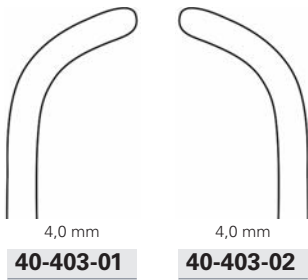

40-403-01

40-403-02

40-403-01 - 40-403-02 14,0 cm, 5 ½"



40-405-05 5,0 mm

40-405-10 10,0 mm

40-405-15 15,0 mm

40-405-20 20,0 mm

40-405-25 25,0 mm

LAMBOTTE

40-405-05 - 40-405-25 21,0 cm, 8 ¼"



40-402-02

SCHNEIDER-SAUERBRUCH

40-402-02 19,0 cm, 7 ½"



40-404-21

SEDILLOT

40-404-21 21,0 cm, 8 ¼"

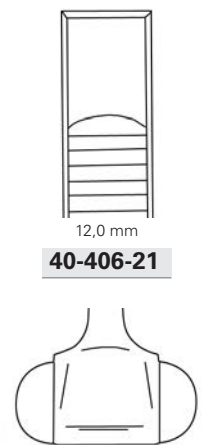

40-406-21

ALEXANDER

40-406-21 21,0 cm, 8 ¼"



SEMB

40-408-01 - 40-408-03	19,0 cm, 7 1/2 "
40-408-02 - 40-408-04	22,0 cm, 8 3/4 "
40-408-05 - 40-408-07	23,0 cm, 9 "

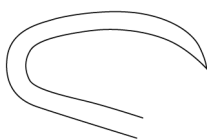

40-409-01

für Kinder, links
for children, left
para niños, izquierda
per bambini, sinistra

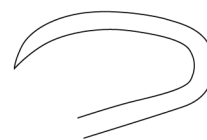

40-409-02

für Kinder, rechts
for children, right
para niños, derecha
per bambini, destra

DOYEN

40-409-01	17,0 cm, 6 3/4 "
------------------	------------------

DOYEN

40-409-02	17,0 cm, 6 3/4 "
------------------	------------------



40-410-01

für Erwachsene, links
for adults, left
para adultos, izquierda
per adultii, sinistra

DOYEN

40-410-01 17,0 cm, 6 $\frac{3}{4}$ "



40-410-02

für Erwachsene, rechts
for adults, right
para adultos, derecha
per adultii, destra

DOYEN

40-410-02 17,0 cm, 6 $\frac{3}{4}$ "



40-411-01

für Erwachsene, links
for adults, left
para adultos, izquierda
per adultii, sinistra

DOYEN

40-411-01 24,0 cm, 9 $\frac{1}{2}$ "



40-411-02

für Erwachsene, rechts
for adults, right
para adultos, derecha
per adultii, destra

DOYEN

40-411-02 24,0 cm, 9 $\frac{1}{2}$ "



40-412-09	9,0 mm
40-412-11	11,0 mm
40-412-13	13,0 mm
40-412-15	15,0 mm
40-412-17	17,0 mm

MC GLAMRY

40-412-09 - 40-412-17 17,0 cm, 6 3/4"



40-413-16



HOEN

40-413-16 16,0 cm, 6 1/4"



40-413-18	15,0 mm
40-413-19	20,0 mm



HOEN

40-413-18 - 40-413-19 19,0 cm, 7 1/2"



40-414-06	6,0 mm
------------------	--------

40-414-10	10,0 mm
------------------	---------

40-414-13	13,0 mm
------------------	---------

40-414-19	19,0 mm
------------------	---------

40-414-25	25,0 mm
------------------	---------

KEY

40-414-06	18,0 cm, 7"
40-414-10 - 40-414-13	19,0 cm, 7 1/2"
40-414-19	20,0 cm, 8"
40-414-25	21,0 cm, 8 1/4"



20,0 mm
40-415-27

PF
FERROZELL

40-415-27 27,0 cm, 10 ³/₄ "



20,0 mm
40-415-27 P

PP
PROPYLUX

40-415-27 P 27,0 cm, 10 ³/₄ "

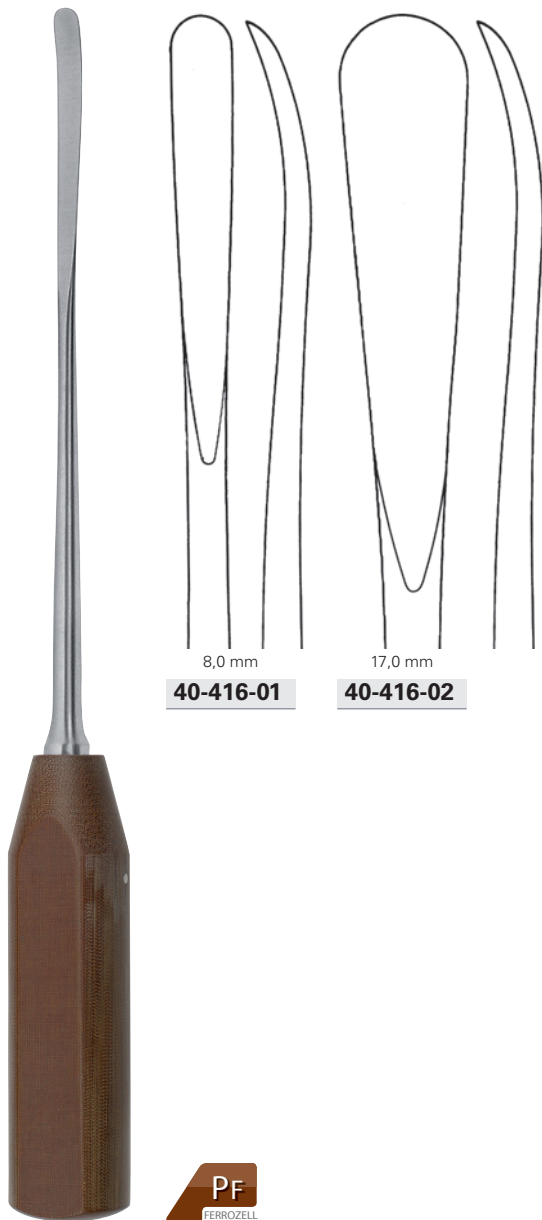

WAGNER

40-416-01 - 40-416-02 33,0 cm, 13"

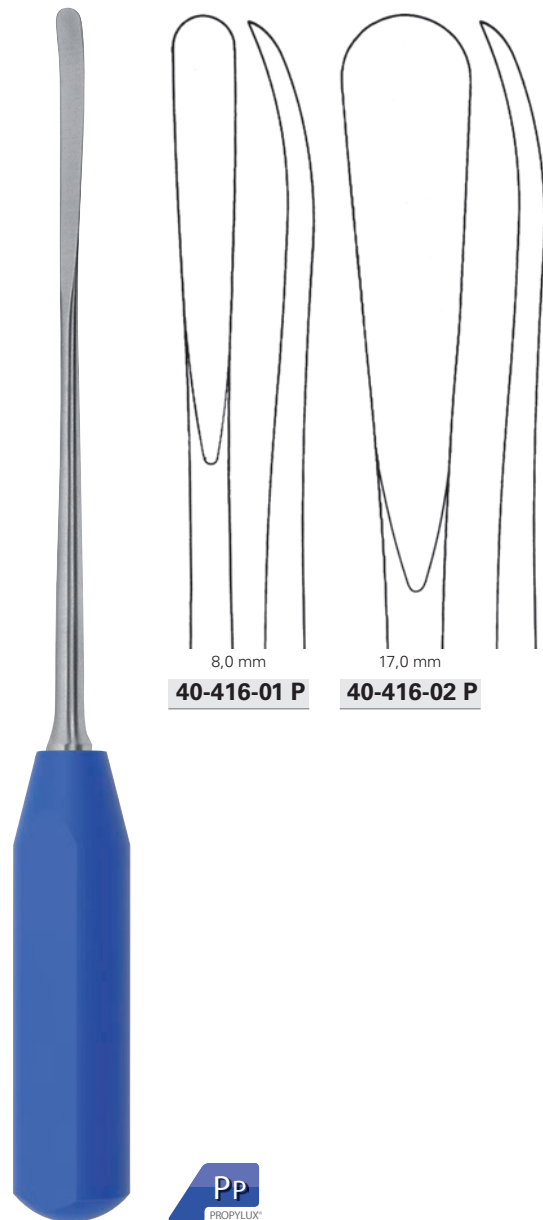

WAGNER

40-416-01 P - 40-416-02 P 33,0 cm, 13"

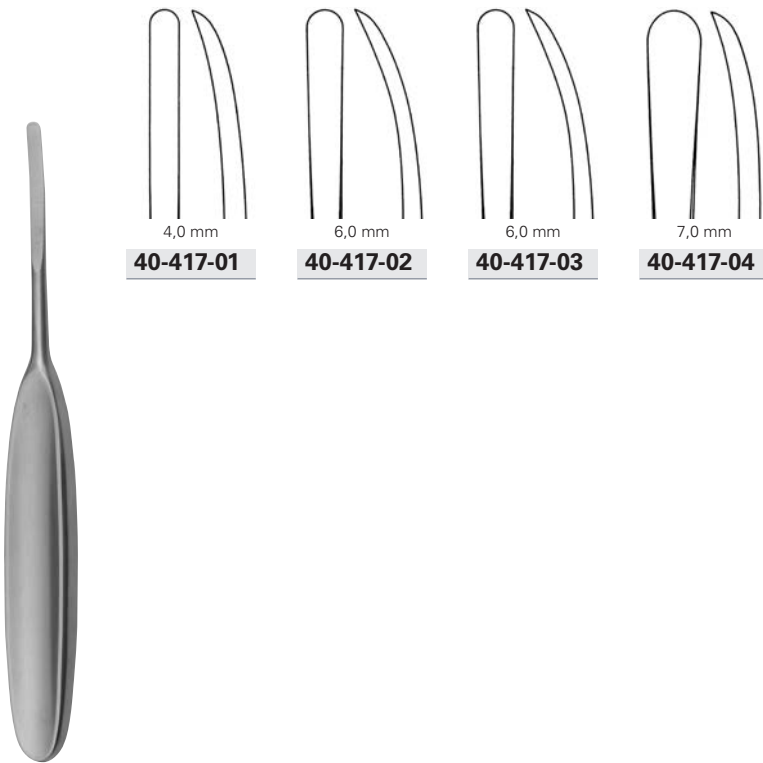

4,0 mm
40-417-01

6,0 mm
40-417-02

6,0 mm
40-417-03

7,0 mm
40-417-04



8,0 mm
40-417-05

MARTIN-CUSHING

40-417-01 - 40-417-02 17,0 cm, 6 3/4 "
40-417-03 - 40-417-04 19,5 cm, 7 3/4 "

MARTIN-CUSHING

40-417-05 17,0 cm, 6 3/4 "

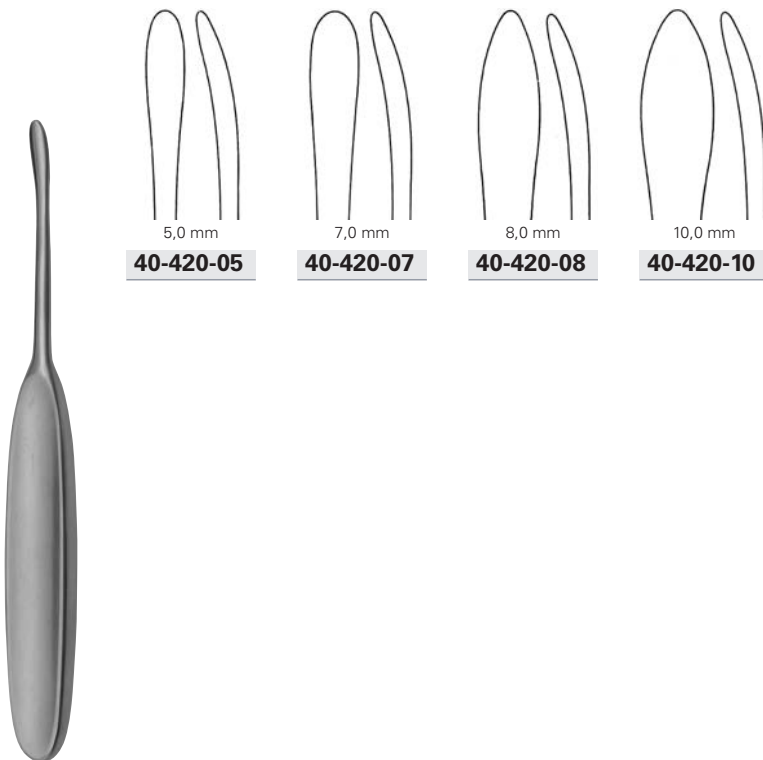

5,0 mm
40-420-05

7,0 mm
40-420-07

8,0 mm
40-420-08

10,0 mm
40-420-10

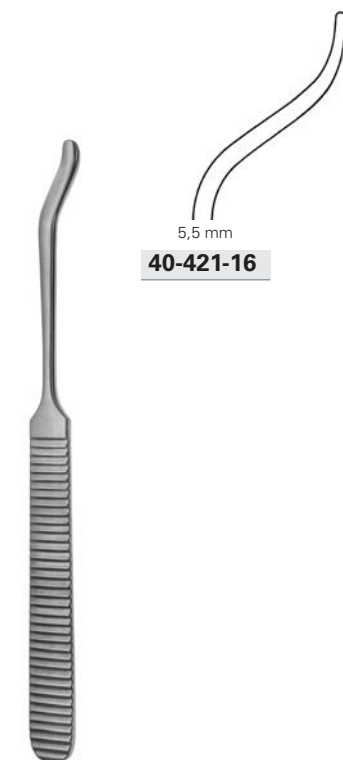

5,5 mm
40-421-16

MARTIN-LANGENBECK

40-420-05 - 40-420-08 17,0 cm, 6 3/4 "
40-420-10 19,5 cm, 7 3/4 "

40-421-16 16,0 cm, 6 1/4 "



Fig. 1 | 10,0 mm

40-418-01



Fig. 2 | 13,0 mm

40-418-02



Fig. 3 | 19,0 mm

40-418-03

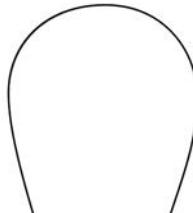

Fig. 4 | 25,0 mm

40-418-04

COBB

40-418-01 - 40-418-04 28,0 cm, 11 "



COBB

40-419-10 - 40-419-25 25,0 cm, 10"

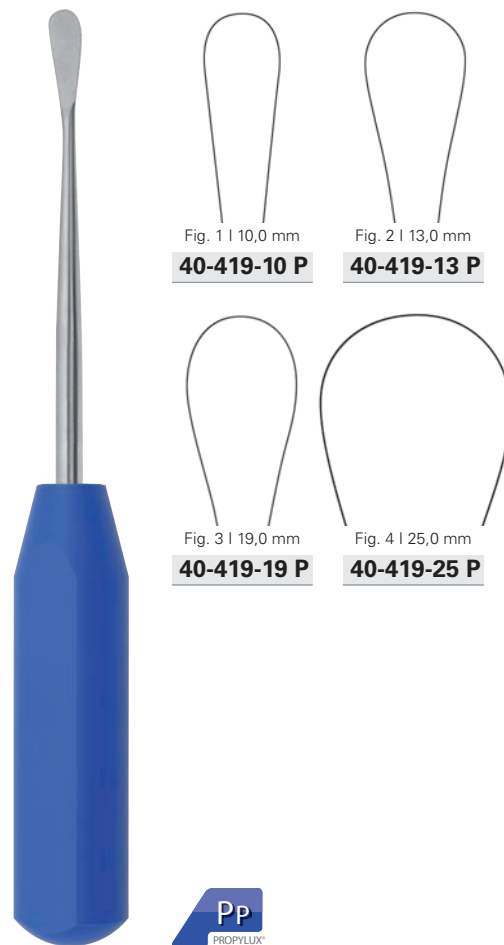

COBB

40-419-10 P - 40-419-25 P 25,0 cm, 10"

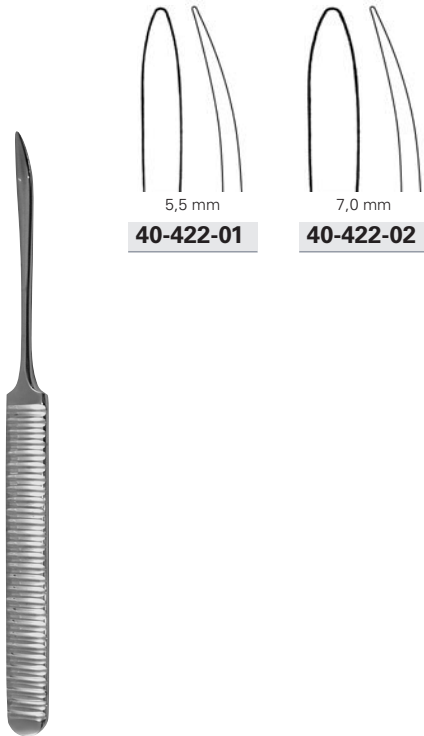

WILLIGER

40-422-01 16,0 cm, 6 1/4"
40-422-02 17,0 cm, 6 3/4"



SEBILEAU

40-423-01 17,0 cm, 6 3/4"



QUERVAIN

40-423-02 19,5 cm, 7 3/4"

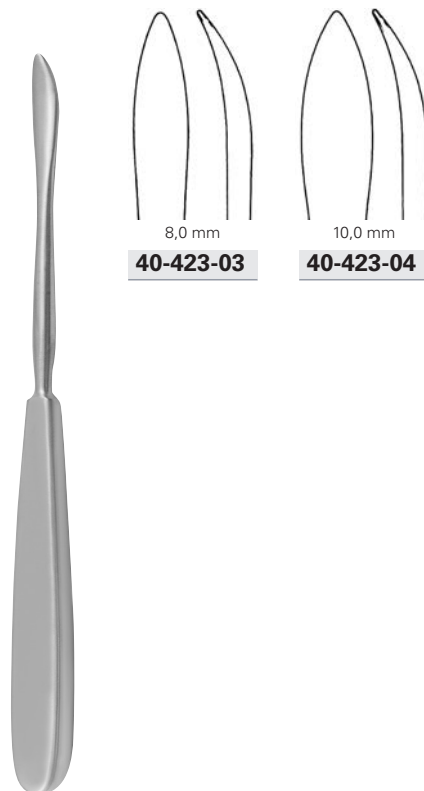

LANGENBECK

40-423-03 - 40-423-04 19,5 cm, 7 3/4"



LANGENBECK

40-423-05 23,0 cm, 9"

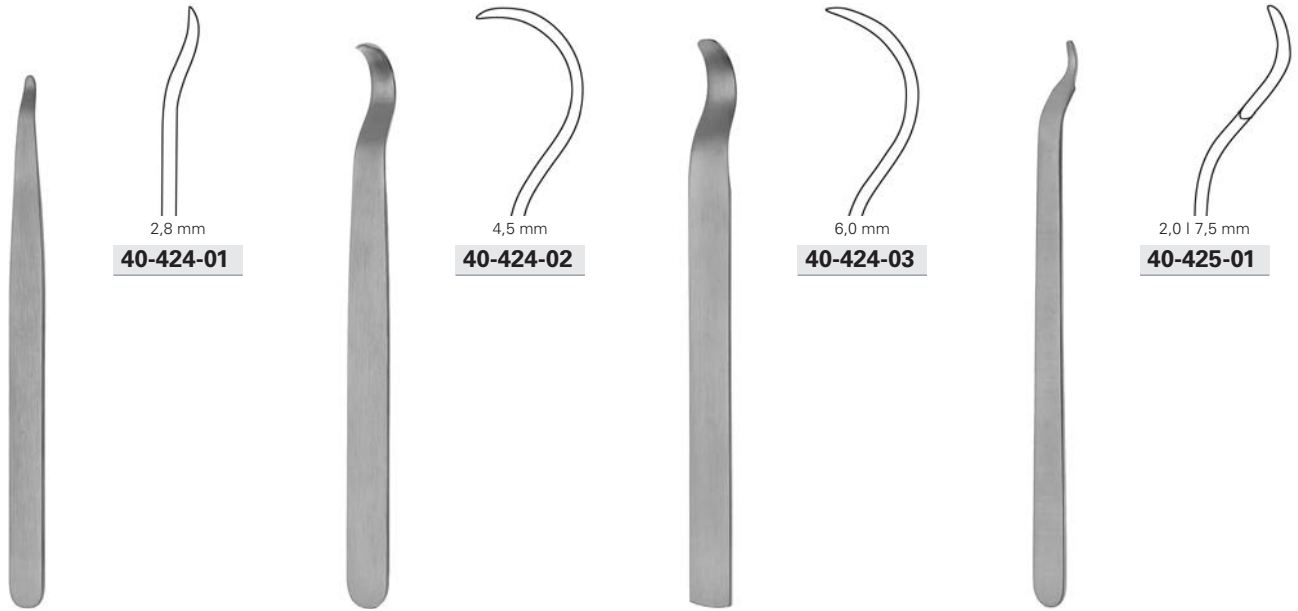

BUCK-GRAMCKO

40-424-01 14,0 cm, 5 ½" **40-424-02** 15,0 cm, 6" **40-424-03** 15,0 cm, 6" **40-425-01** 15,0 cm, 6"

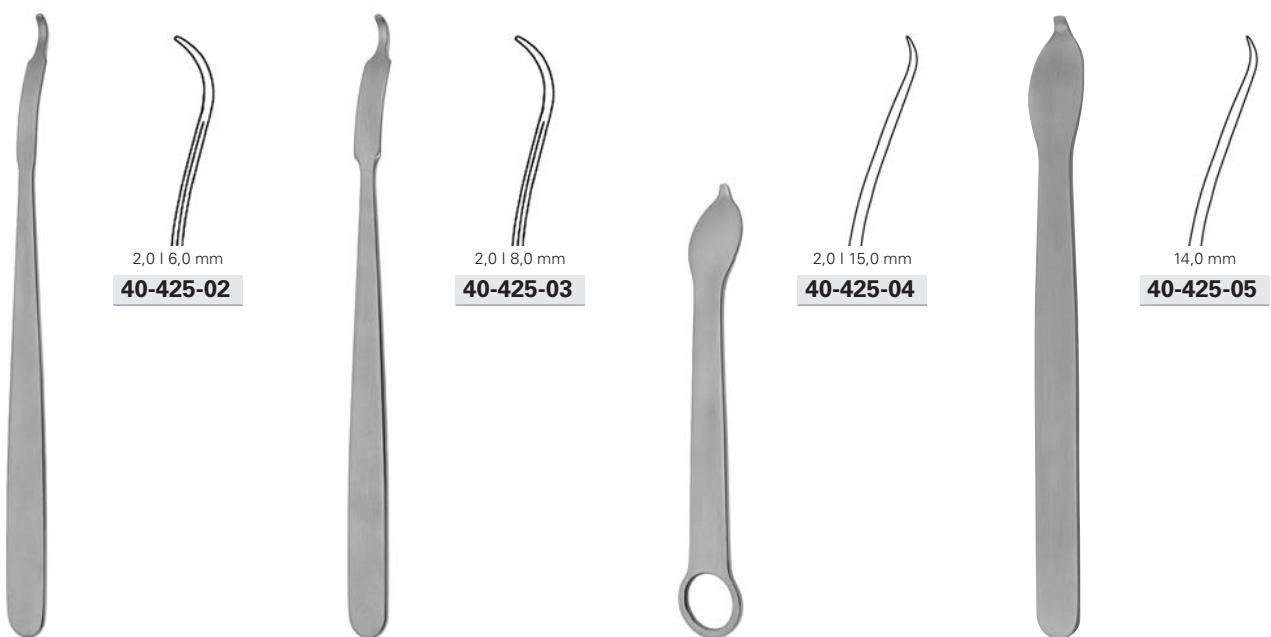

MINI-HOHMANN

MINI-HOHMANN

40-425-02 16,0 cm, 6 ¼" **40-425-03** 16,0 cm, 6 ¼" **40-425-04** 12,0 cm, 4 ¾" **40-425-05** 16,0 cm, 6 ¼"



LANE-TRETHOWAN

40-426-21 21,5 cm, 8 ½ "



LANE

40-426-26 25,5 cm, 10 "



WATSON-JONES

40-426-28 28,0 cm, 11 "



40-426-28



WAGNER

40-427-33 33,0 cm, 13 "



40-427-33



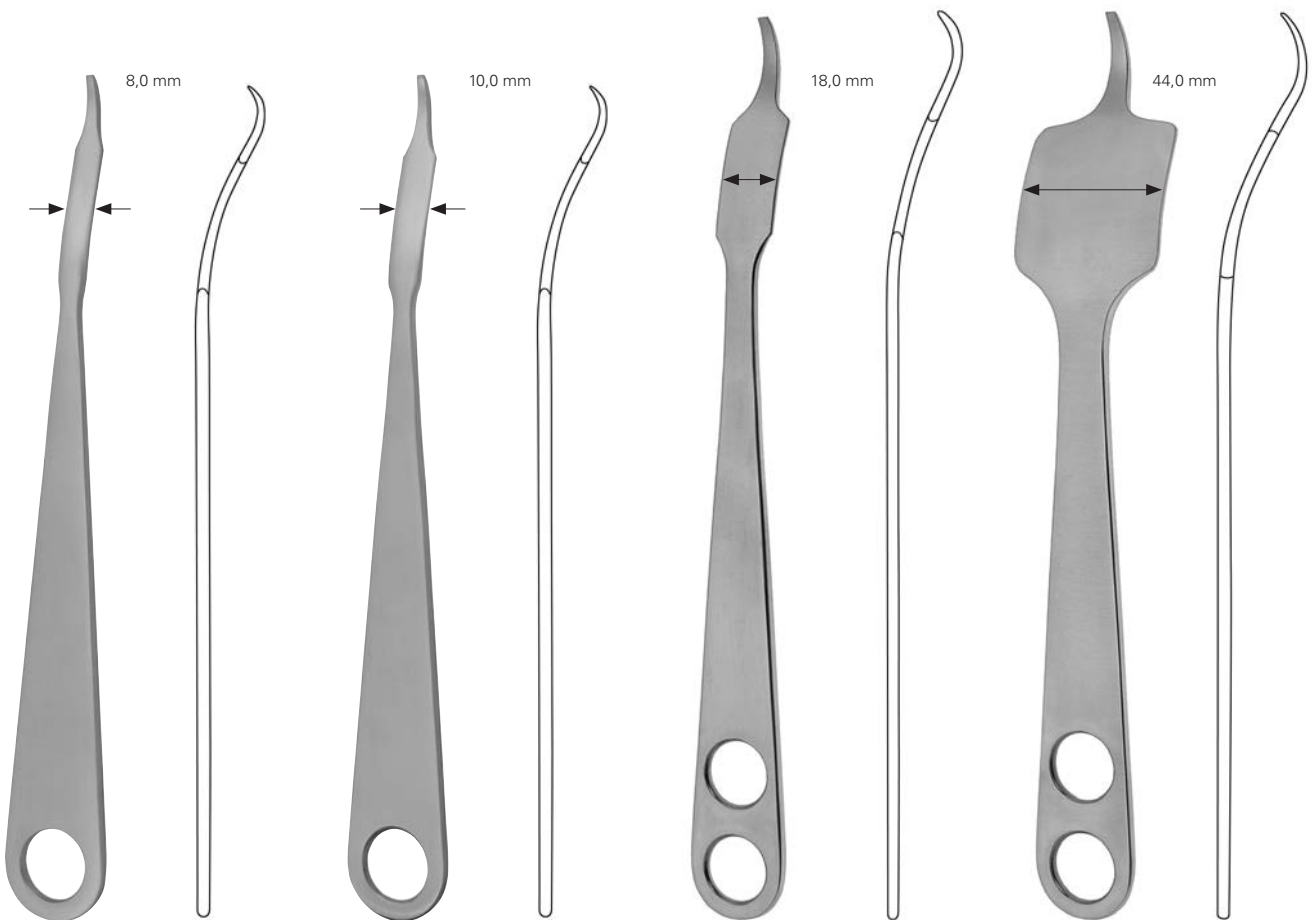

HOHMANN

40-428-00 22,0 cm, 8 3/4 "

HOHMANN

40-428-01 22,0 cm, 8 3/4 "

HOHMANN

40-428-02 24,0 cm, 9 1/2 "

HOHMANN

40-428-03 24,0 cm, 9 1/2 "



HOHMANN

40-428-04 25,5 cm, 10 "

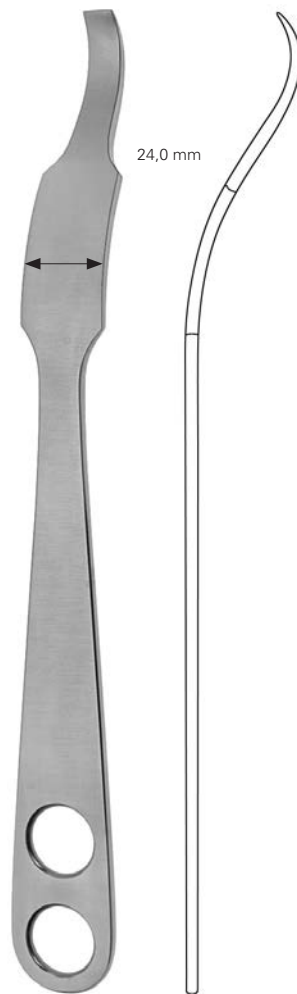

HOHMANN

40-428-06 26,0 cm, 10 ¼ "



HOHMANN

40-428-07 28,5 cm, 11 ¼ "

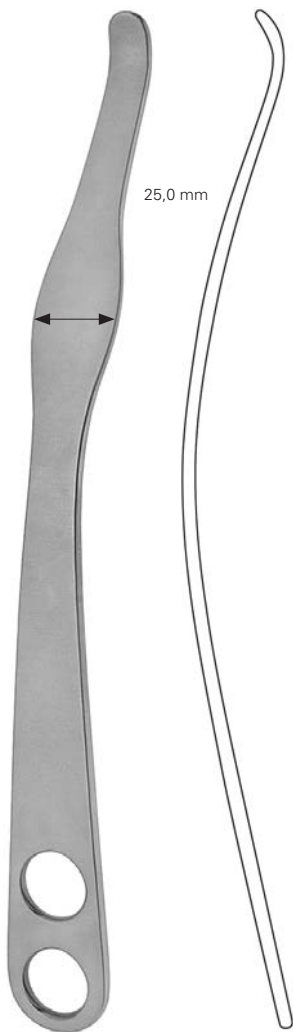

HOHMANN

40-428-08 27,0 cm, 10 ³/₄ "



LANGE-HOHMANN

40-428-09 25,0 cm, 10 "



HOHMANN

40-428-10 23,5 cm, 9 ¹/₄ "



LANGE-HOHMANN

40-429-01 26,5 cm, 10 ½ "



LANGE-HOHMANN

40-429-02 28,0 cm, 11 "

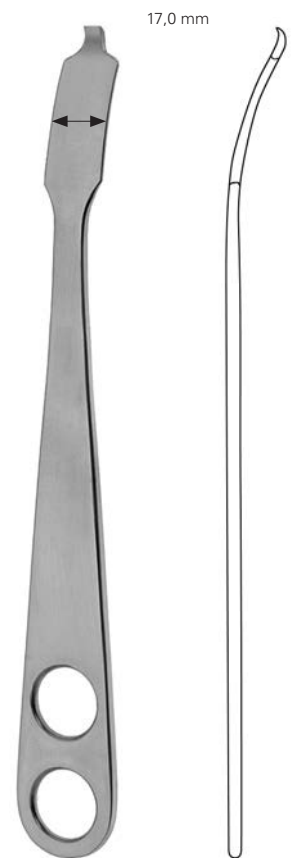

WAGNER

40-430-01 22,0 cm, 8 ¾ "

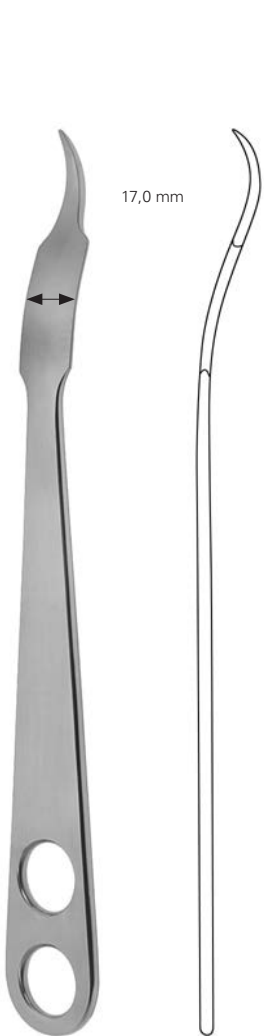

WAGNER

40-430-02 24,0 cm, 9 1/2"



40-430-03 27,0 cm, 10 3/4"

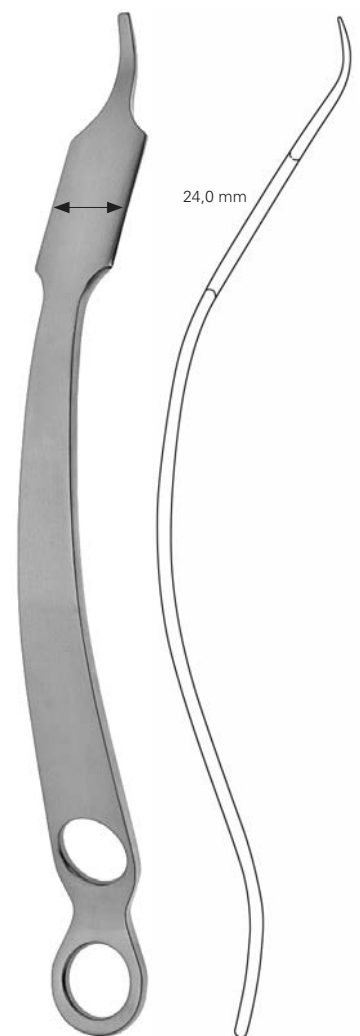

ALDINGER

40-431-27 27,0 cm, 10 3/4"

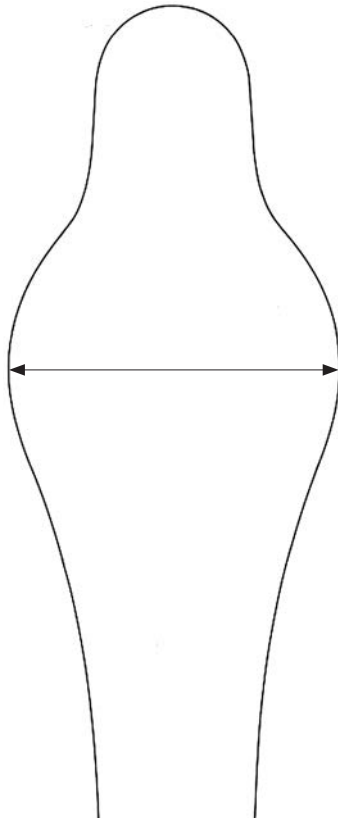

25,0 | 43,0 mm
40-434-23

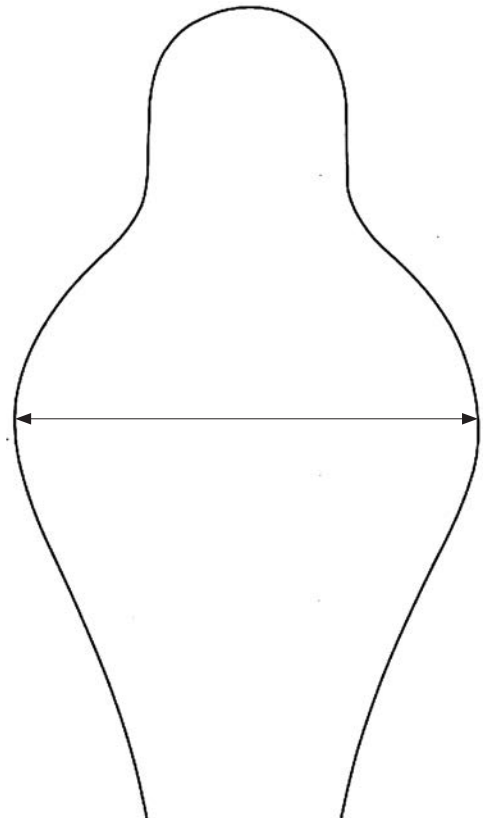

25,0 | 63,0 mm
40-434-24

BENNET

40-434-23 - 40-434-24 24,0 cm, 9 ½"

Luxationshebel
 Luxation lever
 Elevador para luxación
 Leva per lussazione

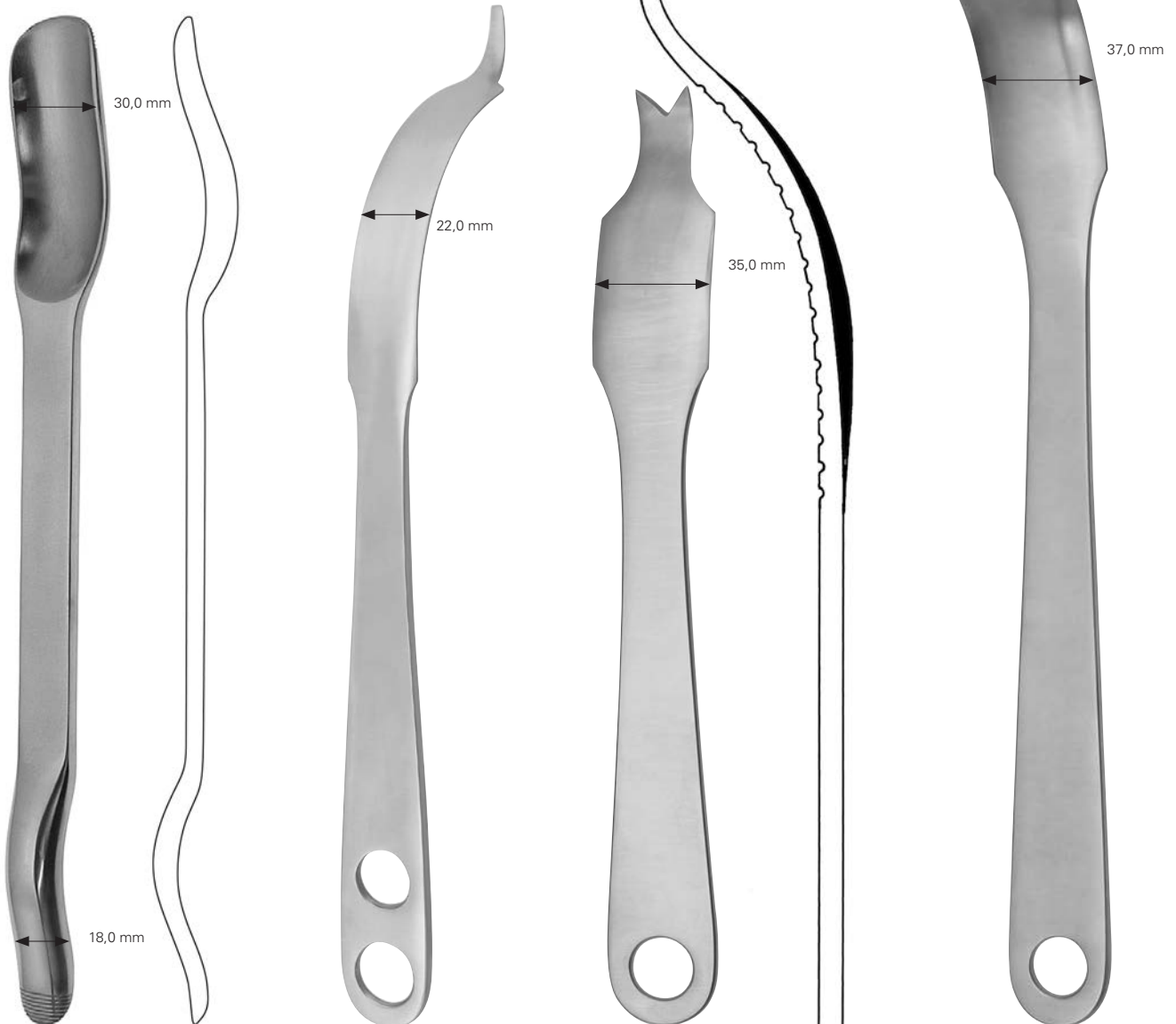

MURPHY-LANE

40-435-34 30,0 cm, 13 1/8"

40-436-24 30,0 cm, 13 1/8"

40-437-28 28,0 cm, 11"

40-437-35 35,0 cm, 13 3/4"



8,0 mm

40-440-01

fein
fine
fina
fina



9,0 mm

40-440-02

grob
coarse
gruesa
grossa

JOSEPH

40-440-01 - 40-440-02 16,5 cm, 6 1/2 "

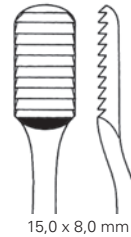

15,0 x 8,0 mm

40-441-01

fein
fine
fina
fina

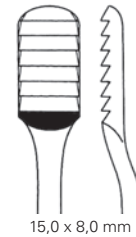

15,0 x 8,0 mm

40-441-02

grob
coarse
gruesa
grossa

LEWIS

40-441-01 - 40-441-02 18,0 cm, 7 "

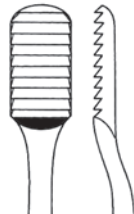

15,0 x 8,0 mm

40-441-11

fein
fine
fina
fina

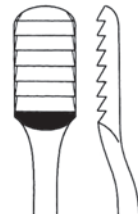

15,0 x 8,0 mm

40-441-12

grob
coarse
gruesa
grossa



LEWIS

40-441-11 - 40-441-12 18,0 cm, 7 "

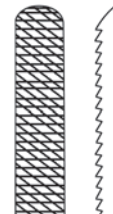

30,0 x 8,0 mm

40-441-21

fein
fine
fina
fina



COTTLE

40-441-21 21,0 cm, 8 1/4 "

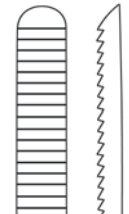

30,0 x 8,0 mm

40-442-21

auf Zug schneidend
downwards stroke
cortante a tracción
tagliante a trazione

COTTLE

40-442-21 21,0 cm, 8 1/4 "

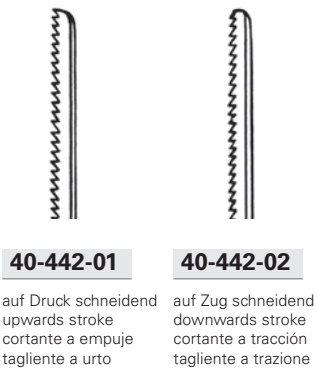

40-442-01

auf Druck schneidend
 upwards stroke
 cortante a empuje
 tagliente a urto

40-442-02

auf Zug schneidend
 downwards stroke
 cortante a tracción
 tagliente a trazione



40,0 x 9,0 mm

40-442-18

auf Zug schneidend
 downwards stroke
 cortante a tracción
 tagliente a trazione



MALTZ

40-442-01 - 40-442-02 17,5 cm, 7 "

MALTZ

40-442-18 18,0 cm, 7 "

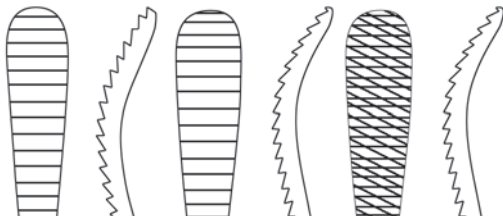

32,0 x 9,0 mm

40-443-01

auf Druck schneidend
 upwards stroke
 cortante a empuje
 tagliente a urto

32,0 x 9,0 mm

40-443-02

auf Zug schneidend
 downwards stroke
 cortante a tracción
 tagliente a trazione

32,0 x 9,0 mm

40-443-03

auf Druck schneidend
 upwards stroke
 cortante a empuje
 tagliente a urto

auf Zug schneidend
 downwards stroke
 cortante a tracción
 tagliente a trazione



45,0 x 6,0 mm

40-444-01



45,0 x 6,0 mm

40-444-02



45,0 x 6,0 mm

40-444-03



AUFRIEHT

40-443-01 - 40-443-03 21,0 cm, 8 ¼ "

GALLAHER

40-444-01 - 40-444-03 17,0 cm, 6 ¾ "

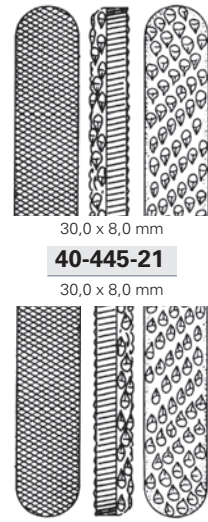
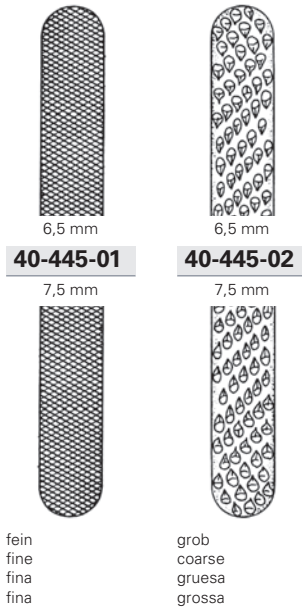

FOMON

40-445-01 - 40-445-02 21,0 cm, 8 ¼ "

FOMON

40-445-21 21,0 cm, 8 ¼ "

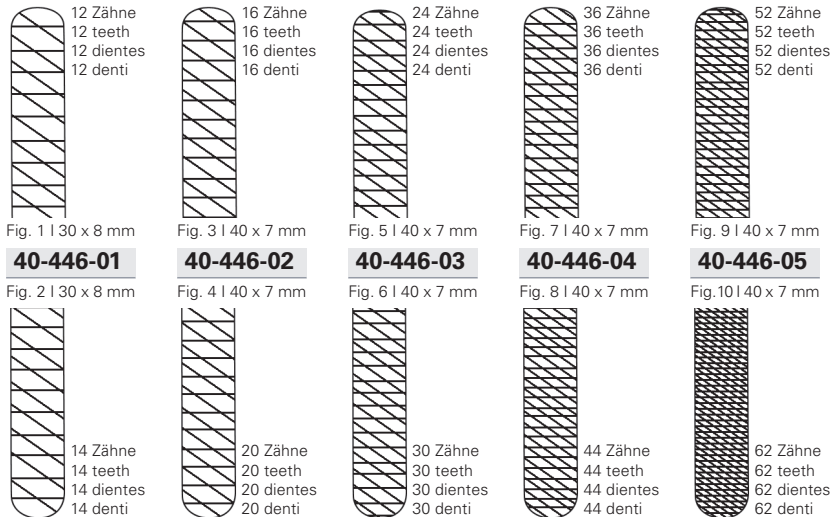

40-446-01 - 40-446-05 20,5 cm, 8 "



40-446-11	Fig. 1 12 T
40-446-12	Fig. 2 14 T
40-446-13	Fig. 3 16 T
40-446-14	Fig. 4 20 T
40-446-15	Fig. 5 24 T
40-446-16	Fig. 6 30 T
40-446-17	Fig. 7 36 T
40-446-18	Fig. 8 44 T
40-446-19	Fig. 9 52 T
40-446-20	Fig. 10 62 T

T = Zähne
 T = teeth
 T = dientes
 T = denti



PARKS

40-446-11 - 40-446-20 21,0 cm, 8 ¼"



40-446-21	Fig. 1 12 T
40-446-22	Fig. 2 14 T
40-446-23	Fig. 3 16 T
40-446-24	Fig. 4 20 T
40-446-25	Fig. 5 24 T
40-446-26	Fig. 6 30 T
40-446-27	Fig. 7 36 T
40-446-28	Fig. 8 44 T
40-446-29	Fig. 9 52 T
40-446-30	Fig. 10 62 T

T = Zähne
 T = teeth
 T = dientes
 T = denti



MALTZ

40-446-21 - 40-446-30 17,0 cm, 6 ¾"

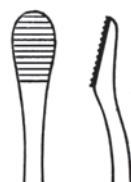

12,0 x 5,0 mm

40-446-50

15,0 x 7,0 mm



12,0 x 5,0 mm

40-446-51

15,0 x 7,0 mm

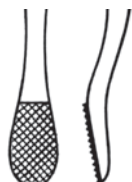
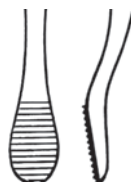

MILLER

40-446-50 - 40-446-51 19,0 cm, 7 ½"

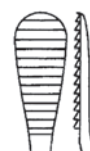

40-447-01

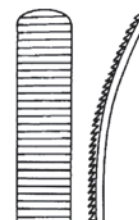

40-447-02

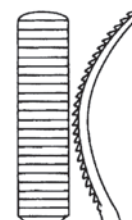

40-447-03

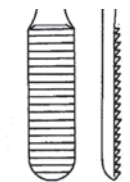

MILLER

40-447-01 - 40-447-03 18,0 cm, 7"

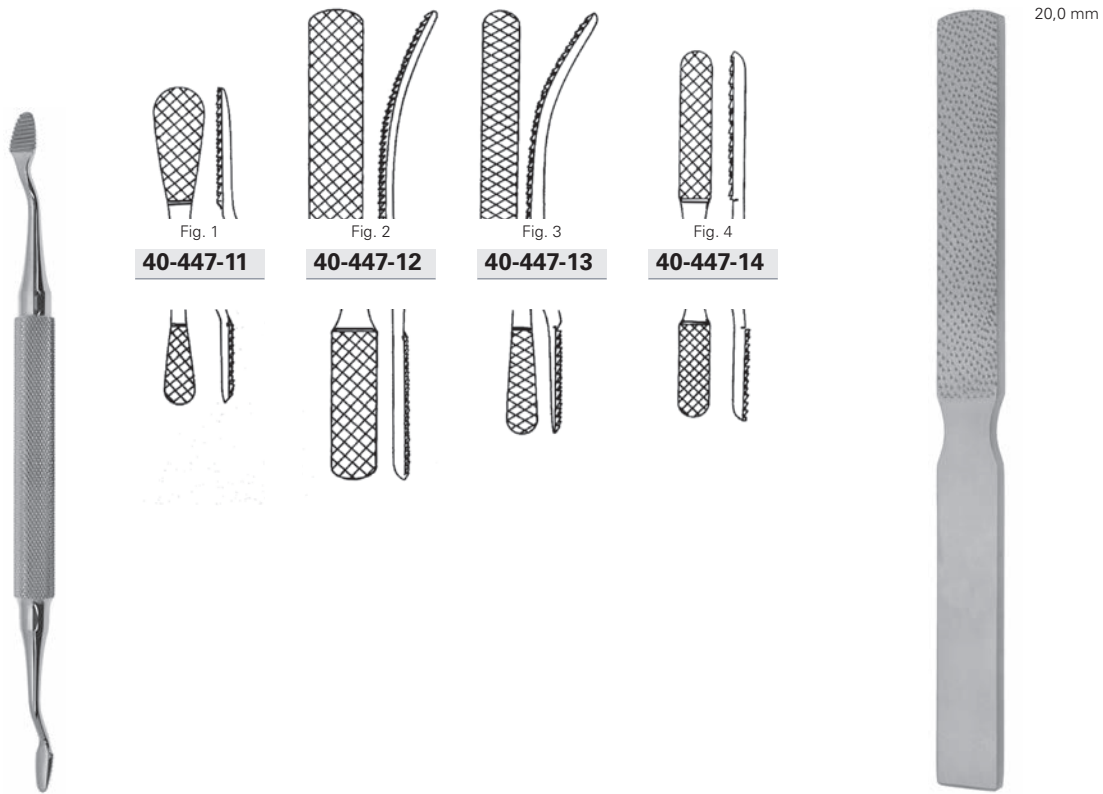

MILLER-COLBURN

40-447-11 - 40-447-14 18,0 cm, 7"

40-448-22 22,0 cm, 8 3/4"

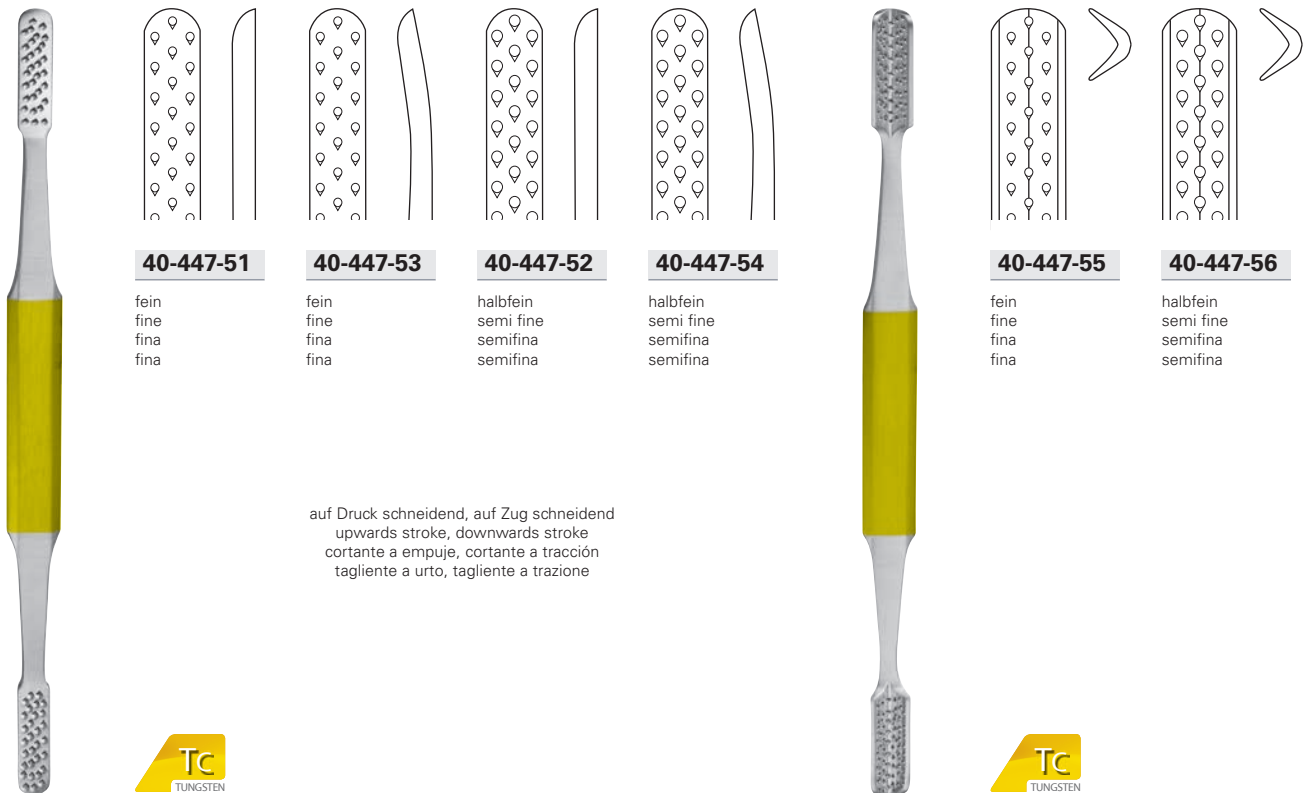

OBWEGESER

40-447-51 - 40-447-54 19,5 cm, 7 3/4"

OBWEGESER

40-447-55 - 40-447-56 19,5 cm, 7 3/4"



13,0 mm

40-449-24 24,0 cm, 9 1/2 "



20,0 mm

40-449-28 28,0 cm, 11 "



20,0 mm

18,0 mm

PUTTI

40-451-27 27,0 cm, 10 3/4 "



10,0 mm

16,0 mm

PUTTI

40-451-30 30,0 cm, 11 3/4 "

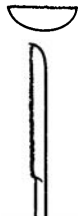

40-452-01



40-452-02



40-452-03



40-452-04

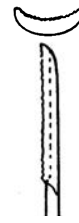

40-452-05



40-452-06



mit Diamantaufgabe
with diamond jaw
con la quijada del diamante
con la mascella del diamante

40-452-01 - 40-452-06 19,0 cm, 7 1/2"



40-453-20



mit Diamantaufgabe
with diamond jaw
con la quijada del diamante
con la mascella del diamante

AUFRICHT

40-453-20 20,0 cm, 8"



40-454-21



mit Diamantaufgabe
with diamond jaw
con la quijada del diamante
con la mascella del diamante

FOMON

40-454-21 21,0 cm, 8 1/4"



40-448-04	Ø 4,0 mm
40-448-05	Ø 5,0 mm
40-448-07	Ø 7,0 mm
40-448-10	Ø 10,0 mm

MOD. SCHWEDEN

40-448-04 - 40-448-10 19,5 cm, 7 3/4 "



40-459-01

2,8 mm



40-459-02

3,2 mm



LUCAS

40-459-01 - 40-459-02 18,0 cm, 7 "



40-460-00



40-460-01

Fig. 0010



40-460-02

Fig. 011



40-460-03

Fig. 112



40-460-05



JACOBSON

40-460-00 14,0 cm, 5 1/2 "

MARTINI

40-460-01 - 40-460-03 14,0 cm, 5 1/2 "

JANSEN

40-460-05 16,0 cm, 6 1/4 "

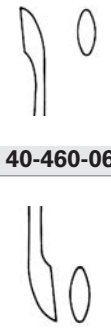

40-460-06

BARTH

40-460-06 18,0 cm, 7 "



40-460-07

40-460-07 21,0 cm, 8 ¼ "



40-461-01
40-461-02
40-461-03
40-461-04

VOLKMANN

40-461-01 13,0 cm, 5 ⅛ "
40-461-02 14,0 cm, 5 ½ "
40-461-03 17,0 cm, 6 ¾ "
40-461-04 20,0 cm, 8 "

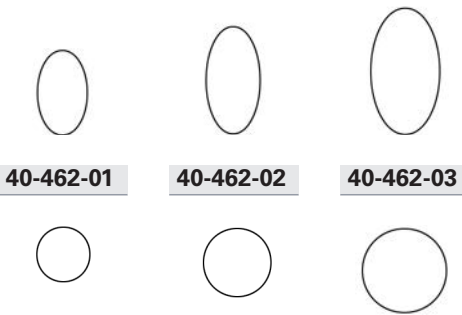

40-462-01

40-462-02

40-462-03

VOLKMANN

40-462-01 13,0 cm, 5 ⅛ "
40-462-02 16,0 cm, 6 ¼ "
40-462-03 20,0 cm, 8 "

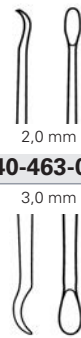

40-463-01

MILLER

40-463-01 18,0 cm, 7 "



40-463-02

JANSEN

40-463-02 16,0 cm, 6 ¼ "

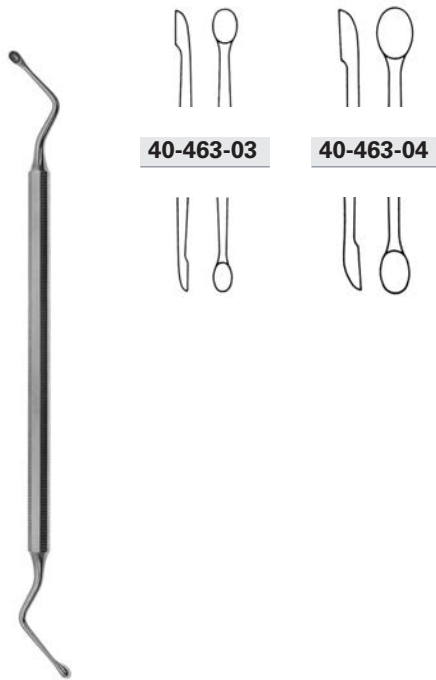

40-463-03

40-463-04

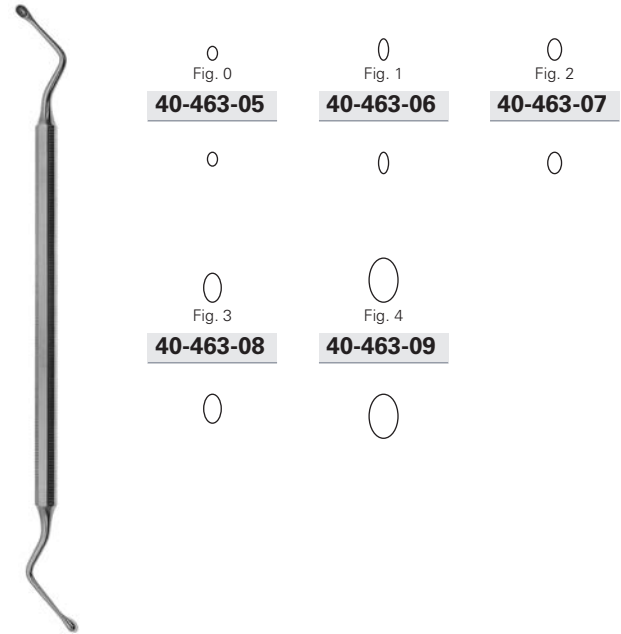

40-463-05

40-463-06

40-463-07

40-463-08

40-463-09

HEMINGWAY

40-463-03 - 40-463-04 17,0 cm, 6 3/4 "

HEMINGWAY

40-463-05 - 40-463-09 17,0 cm, 6 3/4 "

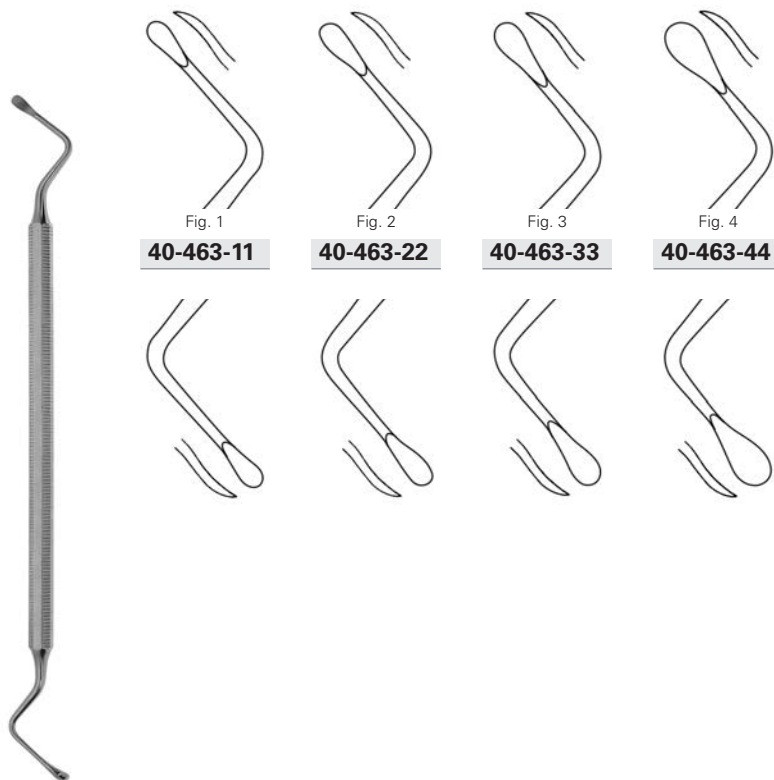

40-463-11

40-463-22

40-463-33

40-463-44

HEMINGWAY

40-463-11 - 40-463-44 18,0 cm, 7 "

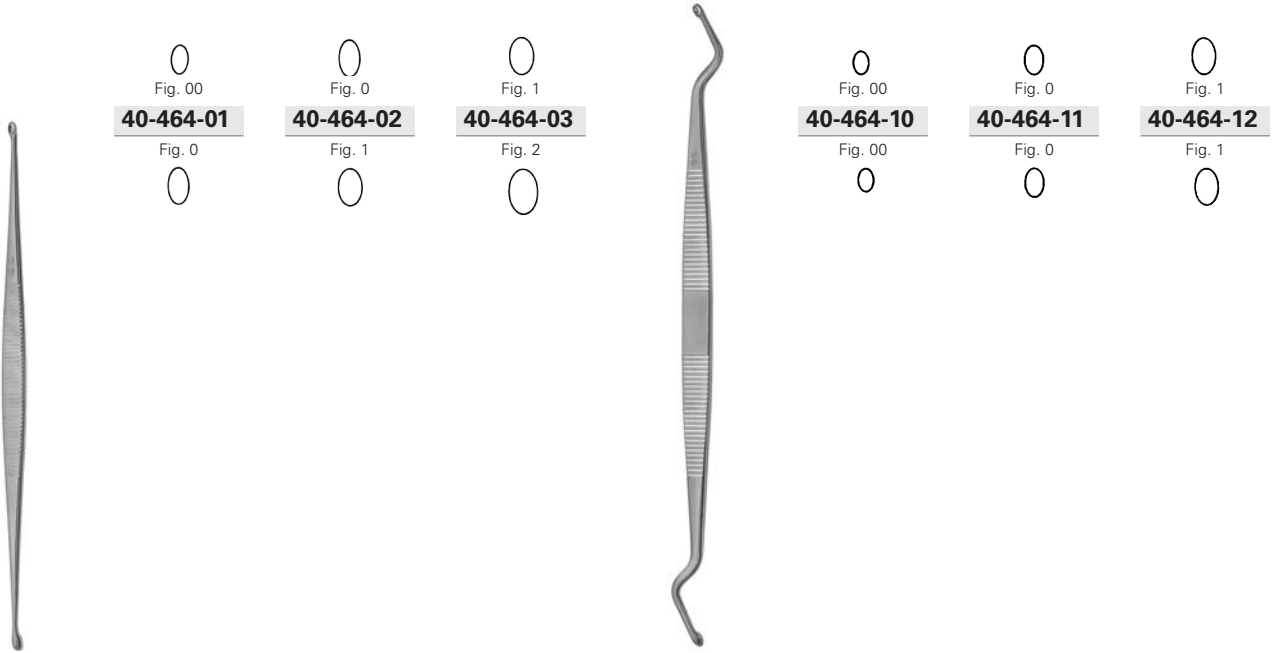

WILLIGER

40-464-01 - 40-464-03 13,0 cm, 5 1/8"

WILLIGER

40-464-10 - 40-464-12 17,0 cm, 6 3/4"

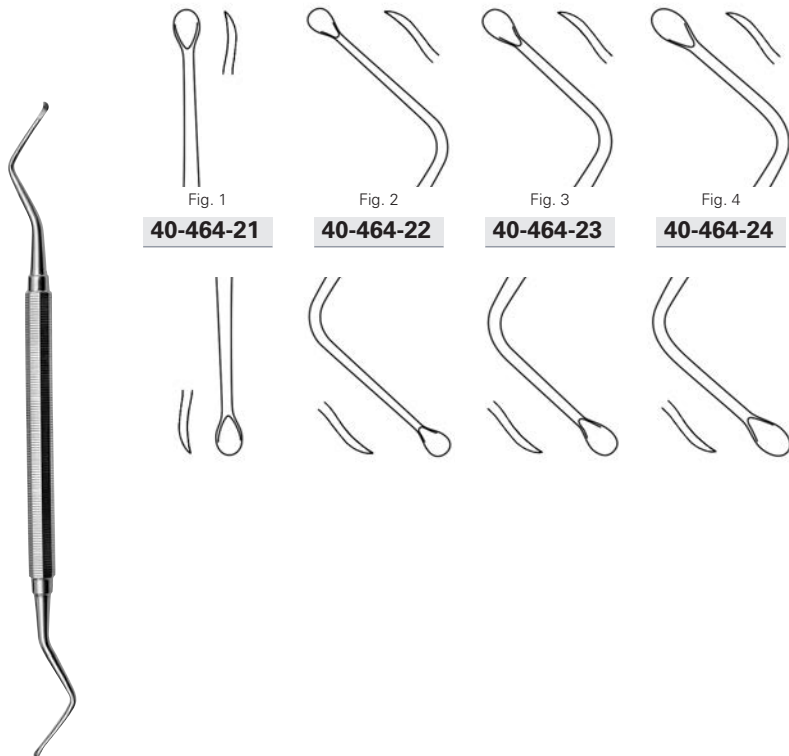

MILLER-COLBURN

40-464-21 - 40-464-24 17,0 cm, 6 3/4"

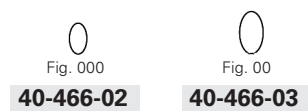
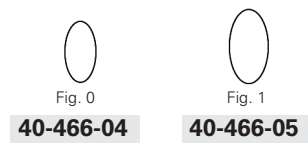
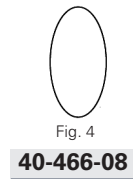
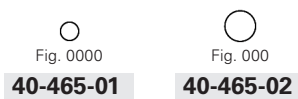
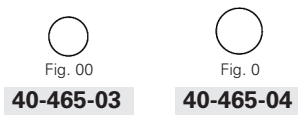
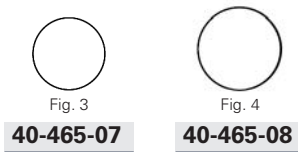

BRUNS

40-465-01 - 40-465-10 17,0 cm, 6 3/4"



SCHEDE

40-466-02 - 40-466-08 17,0 cm, 6 3/4"





Fig. 5

40-467-09



Fig. 6

40-467-10



Fig. 3

40-467-07



Fig. 4

40-467-08



Fig. 1

40-467-05



Fig. 2

40-467-06



Fig. 00

40-467-03



Fig. 0

40-467-04



Fig. 1 | 3,4 mm

40-466-13



Fig. 2 | 5,2 mm

40-466-15

WILLIGER

40-466-13 - 40-466-15 17,0 cm, 6 3/4"



Fig. 0000

40-467-01



Fig. 000

40-467-02

VOLKMANN

40-467-01 - 40-467-10 17,0 cm, 6 3/4"

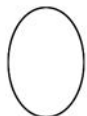

Fig. 5

40-468-09



Fig. 6

40-468-10



Fig. 5

40-468-18



Fig. 6

40-468-19



Fig. 3

40-468-07

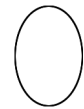

Fig. 4

40-468-08



Fig. 3

40-468-16



Fig. 4

40-468-17



Fig. 1

40-468-05



Fig. 2

40-468-06



Fig. 1

40-468-14



Fig. 2

40-468-15



Fig. 00

40-468-03



Fig. 0

40-468-04



Fig. 00

40-468-12



Fig. 0

40-468-13



Fig. 0000

40-468-01



Fig. 000

40-468-02



Fig. 000

40-468-11



SPRATT

40-468-01 - 40-468-10 17,0 cm, 6 3/4"



SPRATT

40-468-11 - 40-468-19 20,0 cm, 8"





3,3 mm

40-469-06



2,7 mm

40-469-04



3,0 mm

40-469-05



2,0 mm

40-469-02



2,4 mm

40-469-03



1,0 mm

40-469-00



1,7 mm

40-469-01



LEMPERT

40-469-00 - 40-469-06 21,0 cm, 8 ¼"



Fig. 3 | 6,0 mm

40-470-03



Fig. 1 | 4,0 mm

40-470-01



Fig. 2 | 5,0 mm

40-470-02







biegsam
malleable
maleable
malleabile





HALLE

40-470-01 - 40-470-03 21,0 cm, 8 ¼"



- | | |
|---|---|
| 
4,4 mm
40-471-05 | 
5,2 mm
40-471-06 |
| 
2,8 mm
40-471-03 | 
3,6 mm
40-471-04 |



- | | |
|---|---|
| 
5,2 mm
40-472-04 | 
6,8 mm
40-472-05 |
| 
3,6 mm
40-472-02 | 
4,4 mm
40-472-03 |

DAUBENSPECK

40-471-03 - 40-471-06 20,0 cm, 8 "

40-472-02 - 40-472-05 25,0 cm, 9 3/4 "



40-473-02 - 40-473-05 25,0 cm, 9 3/4"

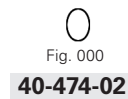
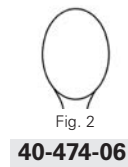
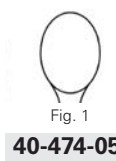
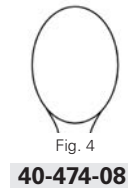
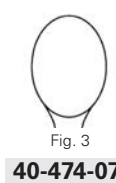

SIMON

40-474-01 - 40-474-10 24,0 cm, 9 1/2"



CASPAR

40-475-02 - 40-475-04 22,0 cm, 8 3/4 "



CASPAR

40-475-02 P - 40-475-04 P 22,0 cm, 8 3/4 "





CASPAR

40-476-02 - 40-476-04 22,0 cm, 8 3/4"



CASPAR

40-476-02 P - 40-476-04 P 22,0 cm, 8 3/4"

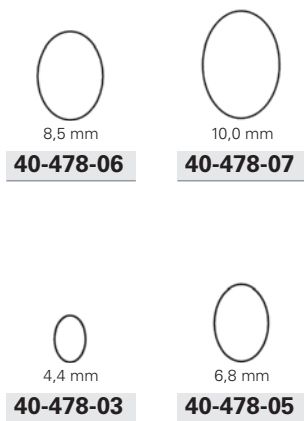

CASPAR

40-478-03 - 40-478-07 27,0 cm, 10 3/4"

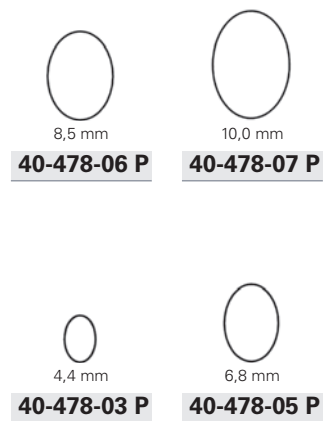

CASPAR

40-478-03 P - 40-478-07 P 27,0 cm, 10 3/4"





Fig. 5

40-479-09

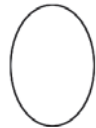

Fig. 6

40-479-10



Fig. 5

40-479-09 P



Fig. 6

40-479-10 P



Fig. 3

40-479-07



Fig. 4

40-479-08



Fig. 3

40-479-07 P



Fig. 4

40-479-08 P



Fig. 1

40-479-05



Fig. 2

40-479-06



Fig. 1

40-479-05 P



Fig. 2

40-479-06 P



Fig. 00

40-479-03



Fig. 0

40-479-04



Fig. 00

40-479-03 P



Fig. 0

40-479-04 P



Fig. 0000

40-479-01



Fig. 000

40-479-02



Fig. 0000

40-479-01 P



Fig. 000

40-479-02 P



VOLKMANN

40-479-01 - 40-479-10 18,5 cm, 7 1/4 "



VOLKMANN

40-479-01 P - 40-479-10 P 18,5 cm, 7 1/4 "



VOLKMANN

40-480-04 - 40-480-09 27,5 cm, 10 3/4"

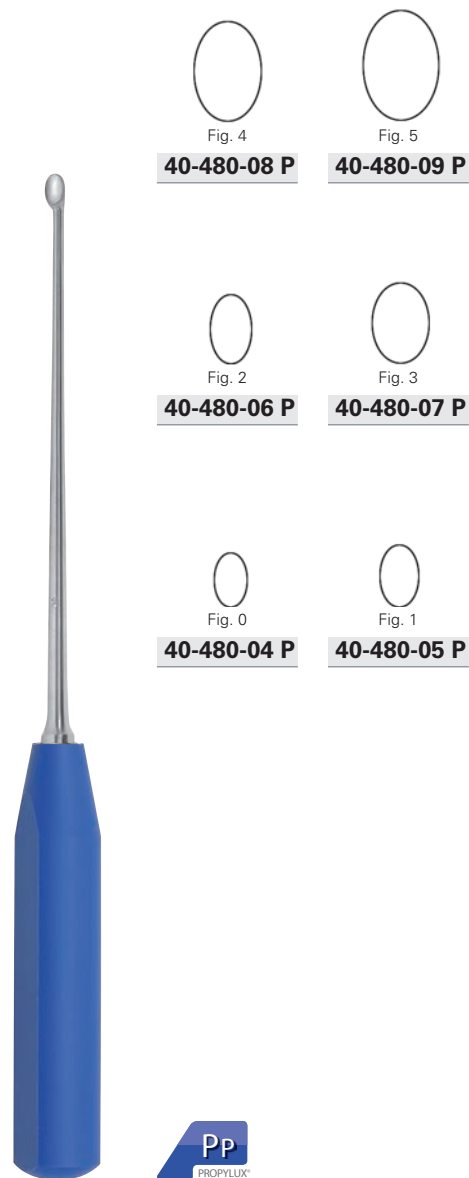

VOLKMANN

40-480-04 P - 40-480-09 P 27,5 cm, 10 3/4"

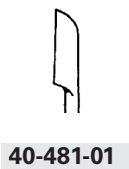

SCOVILLE

40-481-01 - 40-481-03 25,0 cm, 9 3/4"

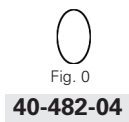
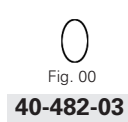
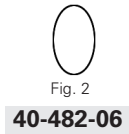
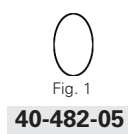
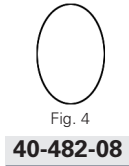
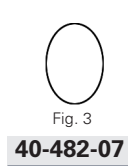
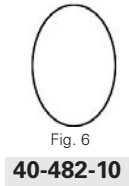
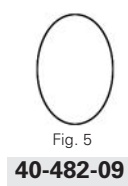

BRUNS

40-482-01 - 40-482-10 23,0 cm, 9"

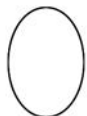

Fig. 5

40-482-19



Fig. 6

40-482-20



Fig. 5

40-483-09



Fig. 6

40-483-10



Fig. 3

40-482-17



Fig. 4

40-482-18



Fig. 3

40-483-07



Fig. 4

40-483-08



Fig. 1

40-482-15



Fig. 2

40-482-16



Fig. 1

40-483-05



Fig. 2

40-483-06



Fig. 00

40-482-13



Fig. 0

40-482-14



Fig. 0000

40-482-11



Fig. 000

40-482-12



Fig. 00

40-483-03



Fig. 0

40-483-04



Fig. 0000

40-483-01



Fig. 000

40-483-02

BRUNS

40-482-11 - 40-482-20 23,0 cm, 9"

BRUNS

40-483-01 - 40-483-10 23,0 cm, 9"





Fig. 1

40-484-01



Fig. 2

40-484-02



Fig. 3

40-484-03



Fig. 4

40-484-04



Fig. 5

40-484-05



Fig. 6

40-484-06

MOD. USA

40-484-01 - 40-484-06 16,0 cm, 6 ¼"



Fig. 5

40-485-05



Fig. 6

40-485-06



Fig. 3

40-485-03



Fig. 4

40-485-04



Fig. 5

40-486-05



Fig. 6

40-486-06



Fig. 3

40-486-03



Fig. 4

40-486-04



Fig. 1

40-485-01



Fig. 2

40-485-02



MOD. USA

40-485-01 - 40-485-06 16,0 cm, 6 ¼"



Fig. 1

40-486-01



Fig. 2

40-486-02



MOD. USA

40-486-01 - 40-486-06 16,0 cm, 6 ¼"



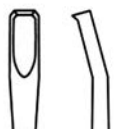

4,0 mm

40-490-04

gezahnt
serrated
dentado
dentellato



5,0 mm

40-490-05

gezahnt
serrated
dentado
dentellato

Küretten
Curettes
Curetas
Curette

CASPAR

40-490-04 - 40-490-05 25,0 cm, 10 "



3,0 mm

40-491-03

gezahnt
serrated
dentado
dentellato



4,0 mm

40-491-04

gezahnt
serrated
dentado
dentellato

Küretten
Curettes
Curetas
Curette

CASPAR

40-491-03 - 40-491-04 27,0 cm, 10 3/4 "



Ø 9,0 mm

40-492-09



Ø 4,0 mm

40-492-04



Ø 7,0 mm

40-492-07

Ringküretten
Ring curettes
Curetas anulares
Curette anulari

CONE

40-492-04 - 40-492-09 23,0 cm, 9"



Ø 9,0 mm

40-492-19



Ø 4,0 mm

40-492-14



Ø 7,0 mm

40-492-17

Ringküretten
Ring curettes
Curetas anulares
Curette anulari

CONE

40-492-14 - 40-492-19 23,0 cm, 9"



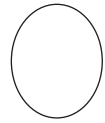

12,2 x 15,2 mm
40-494-09



10,5 x 16,8 mm
40-494-18

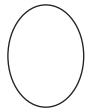

10,2 x 13,7 mm
40-494-07

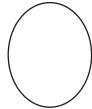

11,2 x 14,0 mm
40-494-08



8,5 x 12,5 mm
40-494-16



9,5 x 14,5 mm
40-494-17



8,1 x 10,2 mm
40-494-05



9,1 x 11,4 mm
40-494-06



6,0 x 9,0 mm
40-494-14



7,0 x 11,0 mm
40-494-15



6,1 x 7,6 mm
40-494-03



7,1 x 8,9 mm
40-494-04



4,5 x 6,4 mm
40-494-12



5,0 x 8,0 mm
40-494-13



4,0 x 5,0 mm
40-494-01



5,0 x 6,4 mm
40-494-02



3,0 x 5,0 mm
40-494-10



3,5 x 5,5 mm
40-494-11



Küretten
Curettes
Curetas
Curette

COBB

40-494-01 - 40-494-09 28,0 cm, 11 "



Scharfe Löffel
Bone curettes
Cucharillas cortantes
Curette per ossa

HATFIELD

40-494-10 - 40-494-18 23,0 cm, 9 "

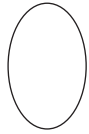

10,5 x 16,8 mm

40-494-28

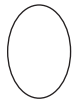

8,5 x 12,5 mm

40-494-26

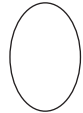

9,5 x 14,5 mm

40-494-27



6,0 x 9,0 mm

40-494-24



7,0 x 11,0 mm

40-494-25



4,5 x 6,4 mm

40-494-22



5,0 x 8,0 mm

40-494-23



3,0 x 5,0 mm

40-494-20



3,5 x 5,5 mm

40-494-21



5,0 mm

40-498-03



3,0 mm

40-498-01



4,0 mm

40-498-02



Scharfe Löffel
 Bone cures
 Cucharillas cortantes
 Curette per ossa



Scharfe Löffel
 Bone cures
 Cucharillas cortantes
 Curette per ossa

HATFIELD

40-494-20 - 40-494-28 28,0 cm, 11 "

BUSHE

40-498-01 - 40-498-03 25,0 cm, 10 "





40-495-01

UFFENORDE

40-495-01 17,0 cm, 6 3/4"



40-495-02

UFFENORDE

40-495-02 17,0 cm, 6 3/4"



40-496-01



40-496-02

KERPEL

40-496-01 - 40-496-02 14,5 cm, 5 3/4"



40-497-01



40-497-02

KERPEL

40-497-01 - 40-497-02 14,5 cm, 5 3/4"



40-501-01

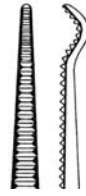

40-502-14



40-501-01 9,5 cm, 3 3/4"



40-502-14 14,0 cm, 5 1/2"



40-503-13 13,5 cm, 5 1/4"

für Kieferrepositionen
 for maxillary reposition
 para la reducción maxilar
 per riposizione mascellare



40-506-12

für Unterkieferfrakturen
 for mandibular fractures
 para fracturas del mandibulo
 per fratture mandibulare



40-505-13 13,5 cm, 5 1/4"



40-506-12 12,0 cm, 4 3/4"



HAASE

40-507-16 16,5 cm, 4 3/4"



LEWIN

40-508-17 17,5 cm, 7"



REILL

40-511-17 17,0 cm, 6 3/4"



40-513-20 20,5 cm, 8"



MEYER

40-515-01 17,0 cm, 6 3/4"



MEYER

40-515-02 20,5 cm, 8"



40-516-18
40-516-21

Patellazangen
 Patella forceps
 Pinza para rotula
 Pinza per rotula

40-516-18 18,5 cm, 7 ¼"
40-516-21 21,0 cm, 8 ¼"



40-518-21

Knöchelfasszange
 Malleolar forceps
 Pinza para el maleolo
 Pinza per malleolo

40-518-21 21,0 cm, 8 ¼"



Knochenhaltezange
 Bone holding forceps
 Pinza para huesos
 Tenaglie per ossa

40-519-18 18,0 cm, 7"

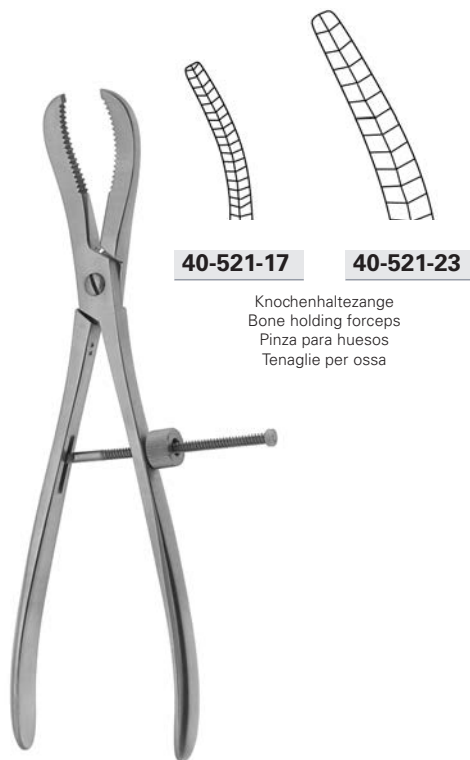

40-521-17

40-521-23

Knochenhaltezange
 Bone holding forceps
 Pinza para huesos
 Tenaglie per ossa

40-521-17 17,0 cm, 6 ¾"
40-521-23 23,5 cm, 9 ¼"



40-523-18

Knochenhaltezange
 Bone holding forceps
 Pinza para huesos
 Tenaglie per ossa

DINGMANN

40-523-18 18,5 cm, 7 ¼"



40-523-19

Knochenhaltezange
 Bone holding forceps
 Pinza para huesos
 Tenaglie per ossa

DINGMANN MODIF.

40-523-19 18,5 cm, 7 ¼"



Sequesterzangen
Sequestrum forceps
Pinzas para secuestro
Pinze per frammento osseo

40-524-20 20,0 cm, 8"



Sequesterzangen
Sequestrum forceps
Pinzas para secuestro
Pinze per frammento osseo

40-525-20 20,0 cm, 8"



Sequesterzangen
Sequestrum forceps
Pinzas para secuestro
Pinze per frammento osseo

VAN BUREN

40-527-23 23,0 cm, 9"

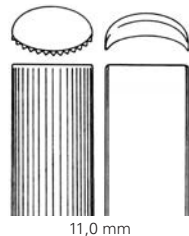

11,0 mm

40-526-22

Knochenformzange
Bone contouring forceps
Pinza para formar huesos
Pinza per formare osso

TESSIER

40-526-22 22,0 cm, 8 3/4"



5,0 mm

40-528-20

Knochenhaltezange
Bone holding forceps
Pinza para huesos
Tenaglie per ossa

LANGENBECK

40-528-20 20,0 cm, 8"

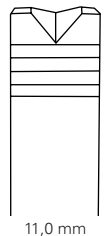

11,0 mm

40-530-20

Knochenhaltezange
Bone holding forceps
Pinza para huesos
Tenaglie per ossa

LANGENBECK

40-530-20 20,0 cm, 8"



12,0 mm
40-532-20

FERGUSSON

40-532-20 20,5 cm, 8 "



8,0 mm
40-533-19

SEMB

40-533-19 19,0 cm, 7 ½ "



8,0 mm
40-535-19

SEMB

40-535-19 19,0 cm, 7 ½ "

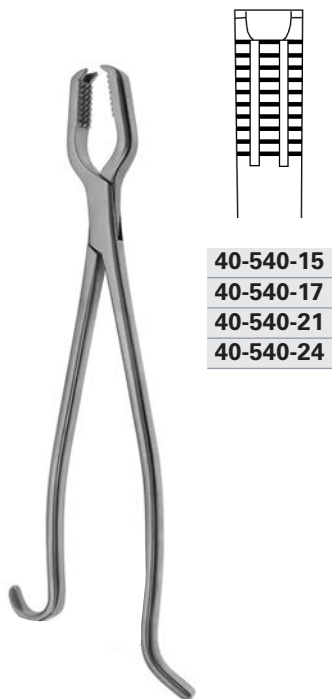

40-540-15
40-540-17
40-540-21
40-540-24

KERN-LANE

40-540-15 15,0 cm, 6 "
40-540-17 17,0 cm, 6 ¾ "
40-540-21 21,0 cm, 8 ¼ "
40-540-24 24,0 cm, 9 ½ "

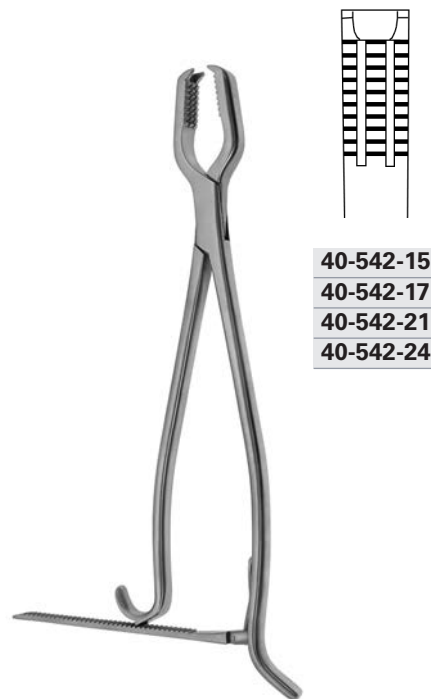

40-542-15
40-542-17
40-542-21
40-542-24

KERN-LANE

40-542-15 15,0 cm, 6 "
40-542-17 17,0 cm, 6 ¾ "
40-542-21 21,0 cm, 8 ¼ "
40-542-24 24,0 cm, 9 ½ "

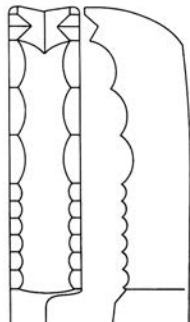

40-536-23	9,0 mm
40-536-25	11,0 mm

verstellbar
adjustable
ajustable
regolabili

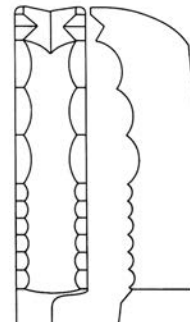

11,0 mm
40-538-25

verstellbar
adjustable
ajustable
regolabili

FARABEU F

40-536-23	23,0 cm, 9"
40-536-25	25,5 cm, 10"

FARABEU F-LAMBOTTE

40-538-25	25,5 cm, 10"
------------------	--------------

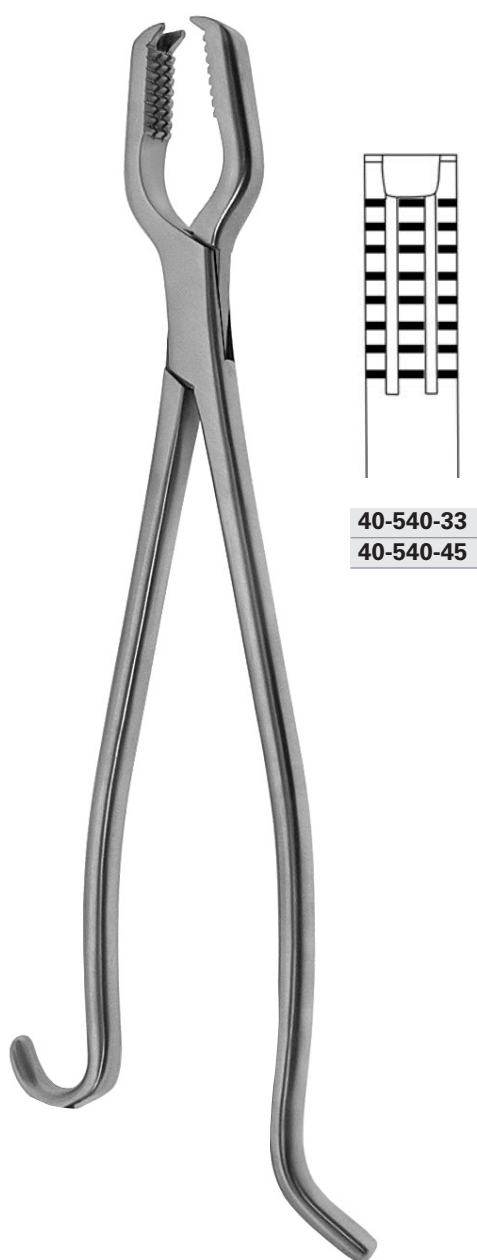

40-540-33
40-540-45

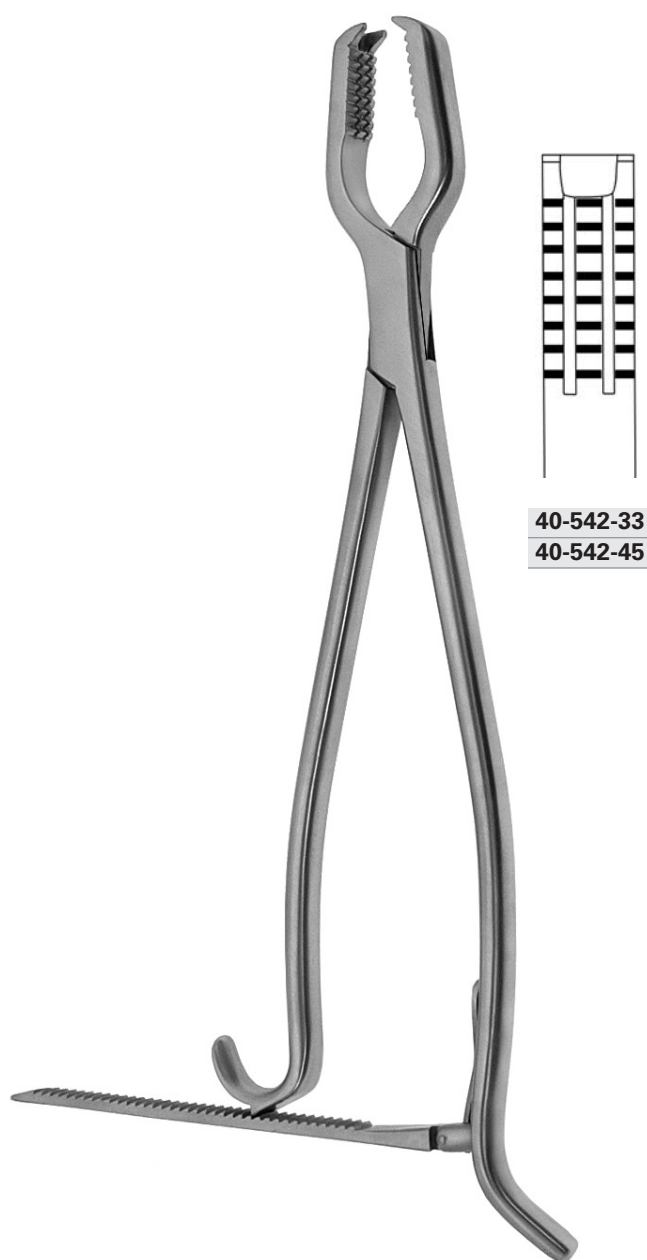

40-542-33
40-542-45

KERN-LANE

40-540-33	33,0 cm, 13 "
40-540-45	45,0 cm, 17 3/4 "

KERN-LANE

40-542-33	33,0 cm, 13 "
40-542-45	45,0 cm, 17 3/4 "

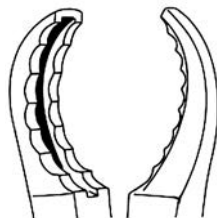

40-546-18
40-546-23
40-546-25
40-546-28

ULRICH

40-546-18	18,0 cm, 7 "
40-546-23	23,0 cm, 9 "
40-546-25	25,0 cm, 9 3/4 "
40-546-28	28,0 cm, 11 "

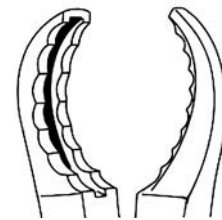

40-547-22
40-547-24
40-547-28

ULRICH

40-547-22	22,0 cm, 8 3/4 "
40-547-24	24,0 cm, 9 1/2 "
40-547-28	28,0 cm, 11 "

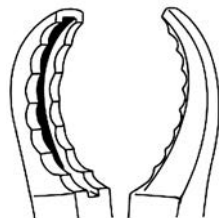
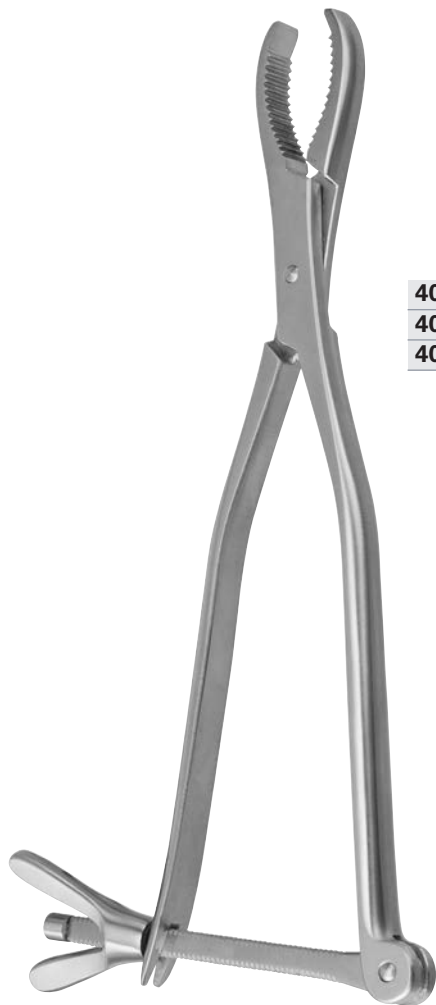

40-548-21	6,5 mm
40-548-27	7,5 mm
40-548-30	8,5 mm

HEY-GROVES

40-548-21	21,0 cm, 8 1/4 "
40-548-27	27,0 cm, 10 3/4 "
40-548-30	30,5 cm, 12 "



40-549-15
40-549-19
40-549-24
40-549-26
40-549-28

selbstzentrierend
 self-centering
 autocentrante
 autocentranti

40-549-15	15,0 cm, 6 "
40-549-19	19,0 cm, 7 1/2 "
40-549-24	24,0 cm, 9 1/2 "
40-549-26	26,0 cm, 10 1/2 "
40-549-28	28,0 cm, 11 "

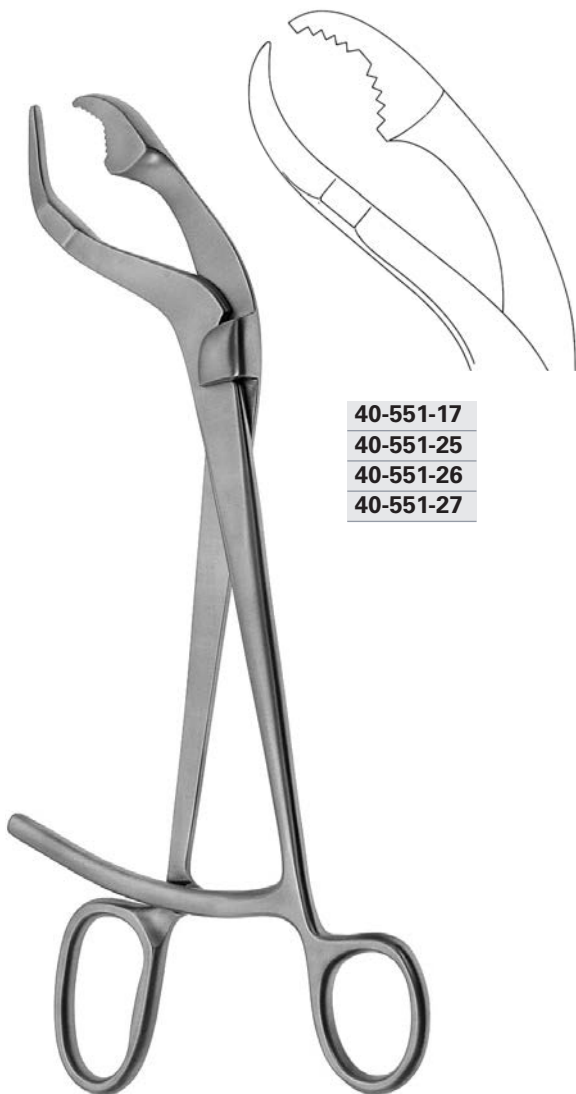

40-551-17
40-551-25
40-551-26
40-551-27

VERBRUGGE

40-551-17	17,0 cm, 6 3/4"
40-551-25	25,0 cm, 10"
40-551-26	26,0 cm, 10 1/2"
40-551-27	27,0 cm, 10 3/4"



verstellbar
adjustable
ajustable
regolabili

LAMBOTTE

40-552-22	22,0 cm, 8 3/4"
40-552-27	27,0 cm, 10 3/4"
40-552-30	30,0 cm, 12"



LAMBOTTE

40-554-22	22,0 cm, 8 ³ / ₄ "
40-554-26	26,0 cm, 10 ¹ / ₄ "
40-554-33	33,0 cm, 13 "



verstellbar
adjustable
ajustable
regolabili

LAMBOTTE

40-555-19	19,0 cm, 7 ¹ / ₂ "
40-555-23	23,0 cm, 9 "
40-555-26	26,0 cm, 10 ¹ / ₄ "



LOWMAN

40-561-12	12,0 cm, 4 3/4"
40-561-18	18,0 cm, 7"
40-561-20	20,0 cm, 8"
40-561-22	22,0 cm, 8 3/4"



LOWMAN-HOGLUND

40-563-12	12,0 cm, 4 3/4"
40-563-18	18,0 cm, 7"
40-563-20	20,0 cm, 8"

Distraktionsklammer für Knochenhalteklammern
Traction bar for bone clamps
Barra de tracción para pinzas porta-huesos
Barra di trazione per tenaglie per ossa



GERSTER

40-564-00	15,0 cm, 6"
------------------	-------------



40-601-01



40-601-02



40-601-01 - 40-601-02 13,0 cm, 5 1/8"



40-603-01



40-603-02



40-603-01 - 40-603-02 13,0 cm, 5 1/8"



40-603-14



KLEINERT-KUTZ

40-603-14 14,0 cm, 5 ½"



40-604-01



HEANLEY

40-604-01 18,0 cm, 7"



40-605-01



STELLBRINK

40-605-01 17,5 cm, 8"

40-605-02 16,5 cm, 6 ½"

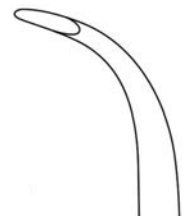

40-605-02



40-607-12



FRIEDMANN-MINI

40-607-12 12,5 cm, 5"



40-607-14



LUER-FRIEDMANN

40-607-14 14,5 cm, 5 ¾"



40-608-14



FRIEDMANN-VICKERS

40-608-14 14,0 cm, 5 ½"



40-609-14



40-609-14 14,0 cm, 5 1/2"



40-611-01

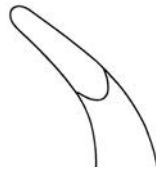

40-611-02

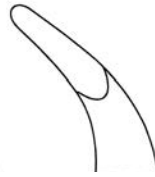

40-611-03



40-611-01 - 40-611-03 15,0 cm, 6"



40-613-14



40-613-14 14,0 cm, 5 1/2"

LUER

CLEVLAND



40-613-17



CLEVLAND

40-613-17 17,0 cm, 6 3/4"



40-615-01



40-615-02



40-615-03



BLUMENTHAL

40-615-01 - 40-615-03 15,5 cm, 6 1/8"



40-616-17



HAKANSSON

40-616-17 17,0 cm, 6 3/4"

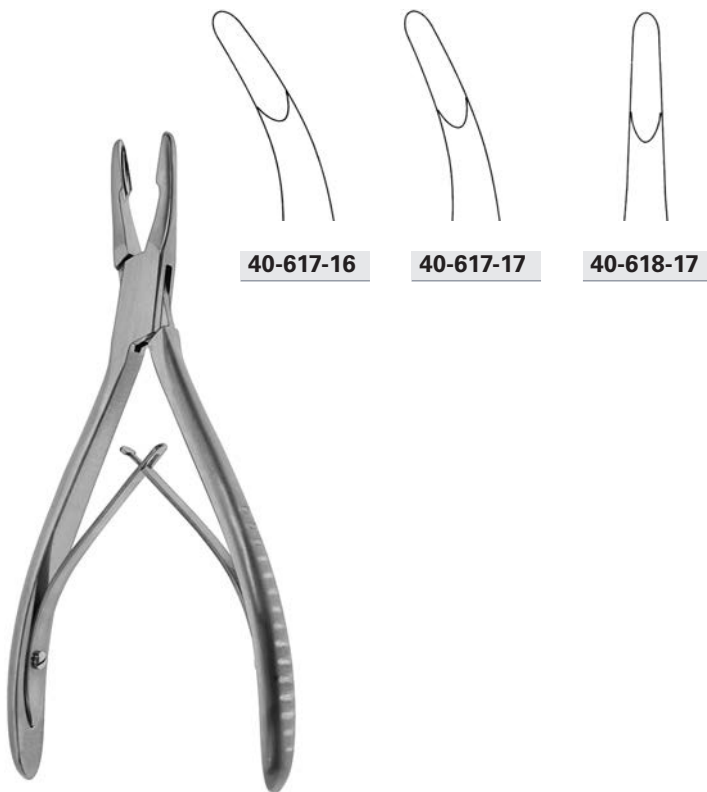

40-617-16

40-617-17

40-618-17

JANSEN

40-617-16 - 40-618-17 17,5 cm, 6 3/4"



40-617-19

JANSEN

40-617-19 19,0 cm, 7 1/2"



40-619-17

HARTMANN

40-619-17 17,0 cm, 6 3/4"



40-621-19

BACON

40-621-19 19,5 cm, 7 3/4"



40-622-16
40-622-20



40-623-16
40-623-20

LEMPERT

40-622-16 - 40-623-16 16,0 cm, 6 1/4"
40-622-20 - 40-623-20 20,0 cm, 8"



40-625-18



BEYER

40-625-18 18,0 cm, 7"



40-627-01



40-627-02



MEAD

40-627-01 - 40-627-02 16,5 cm, 6 1/2"



40-628-17



40-629-17

LUER

40-628-17 - 40-629-17 17,5 cm, 7"

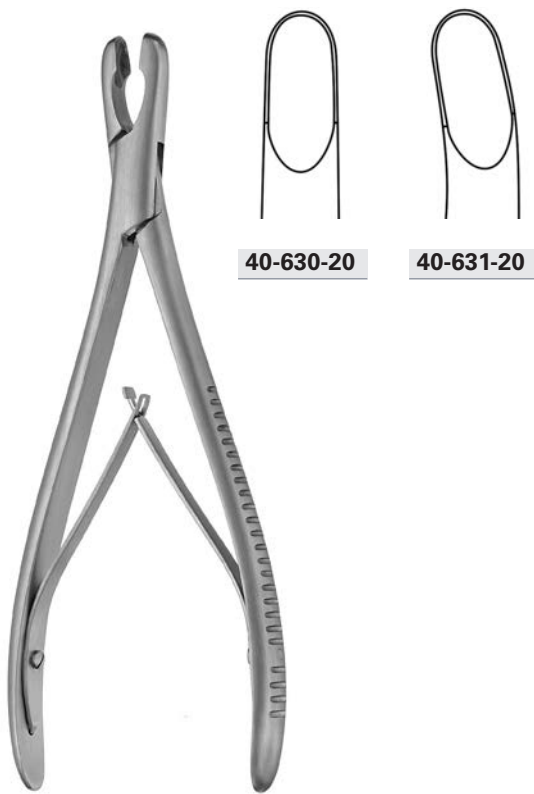

40-630-20

40-631-20

ADSON

40-630-20 - 40-631-20 20,0 cm, 8"

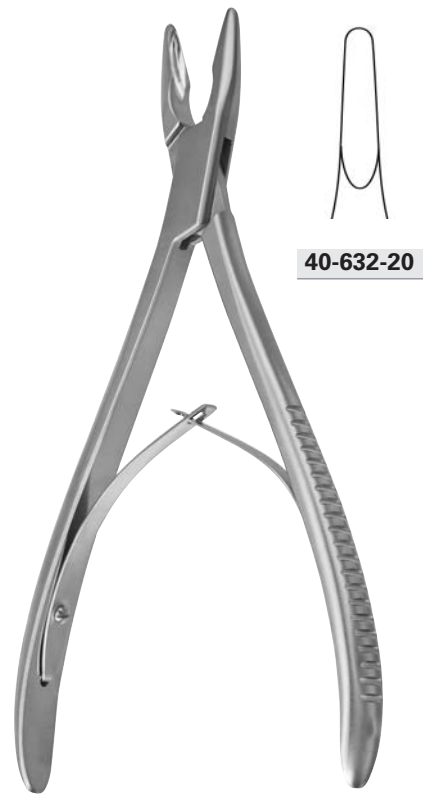

40-632-20

PENNYBACKER

40-632-20 20,5 cm, 8"

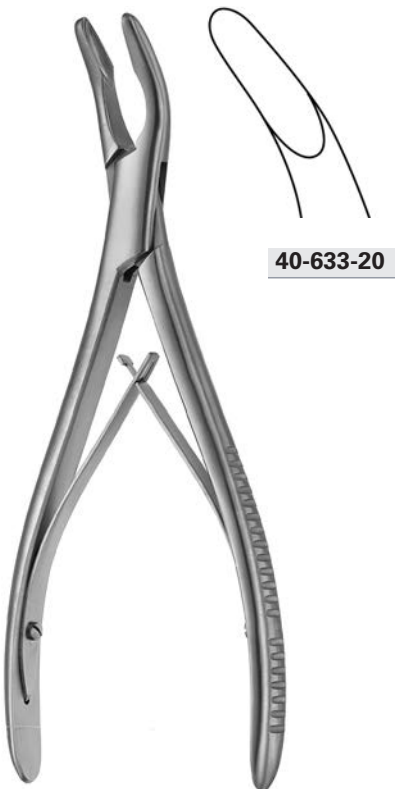

40-633-20

OLIVECRONA

40-633-20 20,0 cm, 8"



40-635-20

GULEKE

40-635-20 20,5 cm, 8"



40-640-02	2,0 mm
40-640-03	3,0 mm
40-640-04	4,0 mm
40-640-05	5,0 mm

40-641-02	2,0 mm
40-641-03	3,0 mm
40-641-04	4,0 mm
40-641-05	5,0 mm

40-641-15



BOEHLER

40-640-02 - 40-641-05 15,5 cm, 6 1/8"

BOEHLER

40-641-15 15,5 cm, 6 1/8"



40-643-01

40-643-02

40-645-17



KLEINERT-KUTZ

40-643-01 - 40-643-02 14,0 cm, 5 1/2"

MAYFIELD

40-645-17 18,0 cm, 7"



40-647-20

MARQUARDT

40-647-20 20,0 cm, 8 "



40-649-18

BEYER

40-649-18 18,0 cm, 7 "



40-651-18

ZAUFAL-JANSEN

40-651-18 18,0 cm, 7 "



40-652-04	4,0 mm
40-652-05	5,0 mm
40-652-06	6,0 mm
40-652-07	7,0 mm

40-653-04	4,0 mm
40-653-05	5,0 mm
40-653-06	6,0 mm
40-653-07	7,0 mm

RUSKIN

40-652-04 - 40-653-07 18,0 cm, 7 "



3,0 mm

40-657-24



3,0 mm

40-657-23



40-655-05	5,0 mm
40-655-06	6,0 mm
40-655-07	7,0 mm



ROETTGEN-RUSKIN

40-655-05 - 40-655-07 24,0 cm, 9 ½"



3,0 mm

40-656-24



SMITH-PETERSEN

40-656-24 - 40-657-24 24,0 cm, 9 ½"

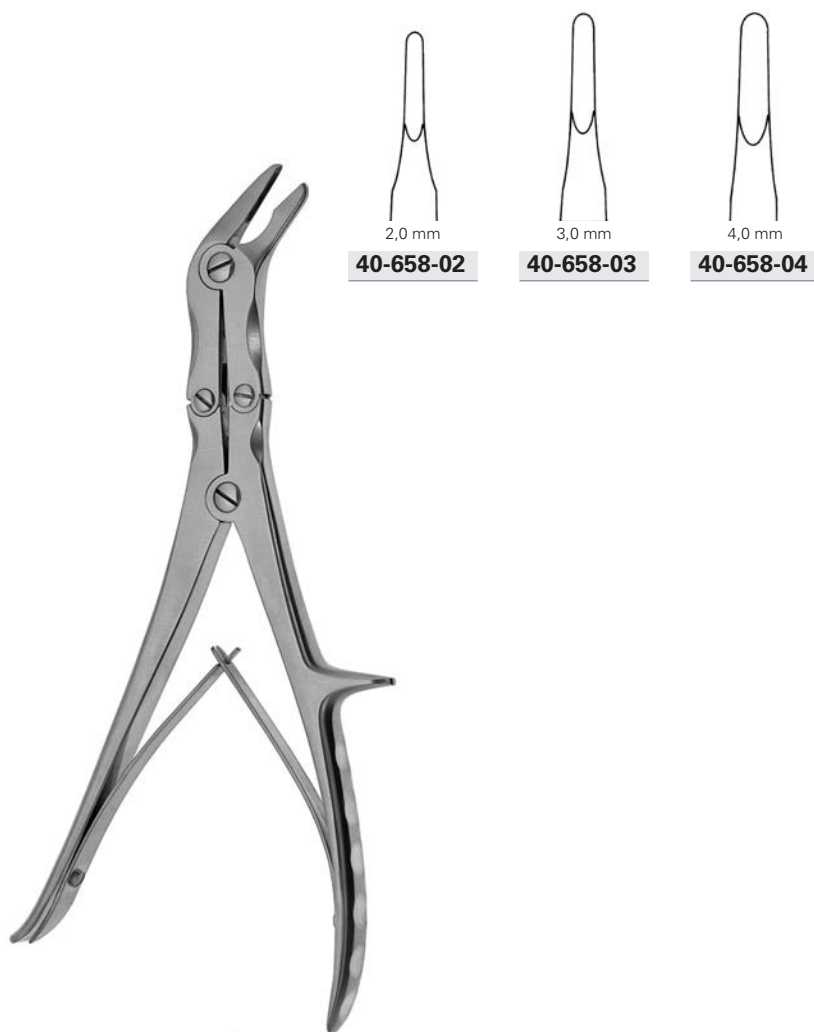

ECHLIN

40-658-02 - 40-658-04 23,0 cm, 9"



FRYKHOLM

40-659-24 24,0 cm, 9 ½"



STILLE

40-660-06 23,0 cm, 9"



40-662-03	3,0 mm
40-662-04	4,0 mm
40-662-05	5,0 mm
40-662-06	6,0 mm
40-662-07	7,0 mm
40-662-08	8,0 mm

LEKSELL-STILLE

40-662-03 - 40-662-08 24,0 cm, 9 1/2"



40-662-13	3,0 mm
40-662-14	4,0 mm
40-662-15	5,0 mm
40-662-16	6,0 mm
40-662-17	7,0 mm
40-662-18	8,0 mm

LEKSELL

40-662-13 - 40-662-18 24,0 cm, 9 1/2"



STILLE-RUSKIN

40-663-24 23,0 cm, 9"

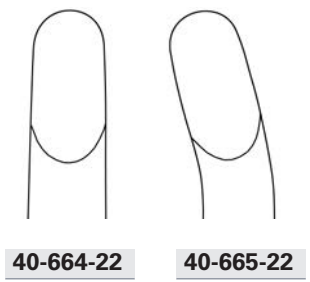

LUER-STILLE

40-664-22 - 40-665-22 22,0 cm, 8 3/4"

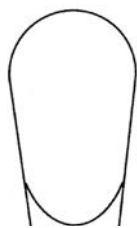

40-664-23
40-666-27



40-665-23
40-667-27



40-669-19



40-669-24



LUER-STILLE

40-664-23 - 40-665-23 23,0 cm, 9 "
40-666-27 - 40-667-27 27,0 cm, 10³/₄ "

MARKWALDER

40-669-19 19,0 cm, 7 1/2 "

SEMB

40-669-24 24,0 cm, 9 1/2 "

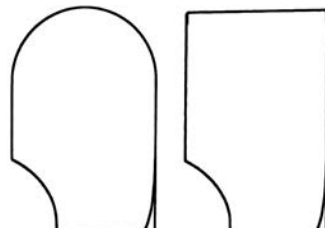

40-670-01

40-670-02

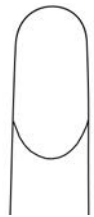
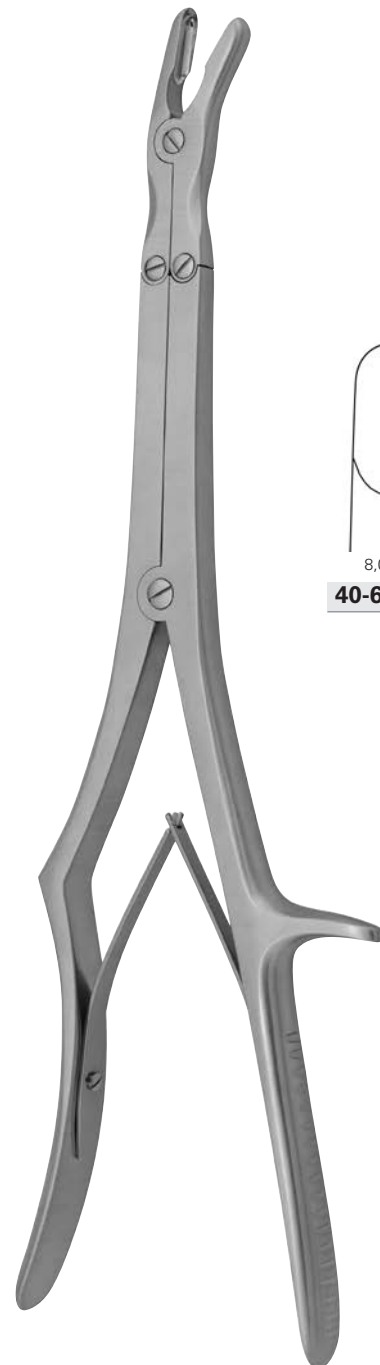

8,0 mm

40-672-08

SAUERBRUCH-CORYLLOS

40-670-01 - 40-670-02 31,0 cm, 12 ¼"

SYPERT

40-672-08 36,0 cm, 14 ½"



40-701-15

CLEVELAND

40-701-15 15,0 cm, 6 "



40-701-17

CLEVELAND

40-701-17 17,0 cm, 6 3/4 "

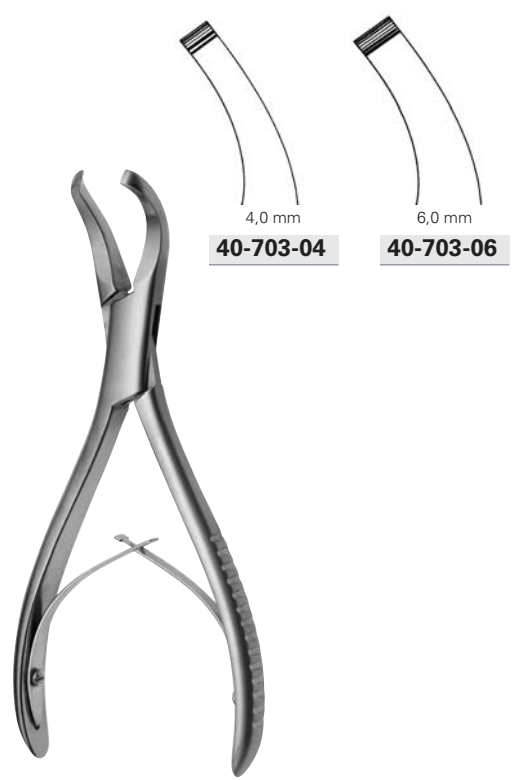

40-703-04

40-703-06

GARDNER

40-703-04 - 40-703-06 16,0 cm, 6 1/4 "



40-704-19

COTTLE-KAZANJIAN

40-704-19 19,0 cm, 7 1/4 "



LISTON

40-706-14 - 40-707-14 14,0 cm, 5 1/2 "
 40-706-17 - 40-707-17 17,0 cm, 6 3/4 "
 40-706-20 - 40-707-19 20,0 cm, 8 "
 40-706-22 - 40-707-22 22,0 cm, 8 3/4 "

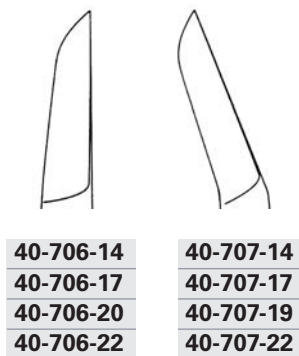

40-706-14

40-706-17

40-706-20

40-706-22

40-707-14

40-707-17

40-707-19

40-707-22



40-708-15



40-709-15



40-710-17



BOEHLER

43-708-15 - 40-709-15 14,5 cm, 5 3/4"

40-710-17 17,0 cm, 6 3/4"

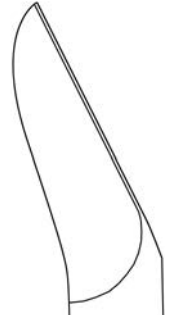

40-715-24



40-712-19



40-713-19



40-711-18



RUSKIN-LISTON

40-712-19 - 40-713-19 19,0 cm, 7 1/2"

MC INDOE

40-711-18 17,5 cm, 7"

LISTON

40-715-24 24,0 cm, 9 1/2"

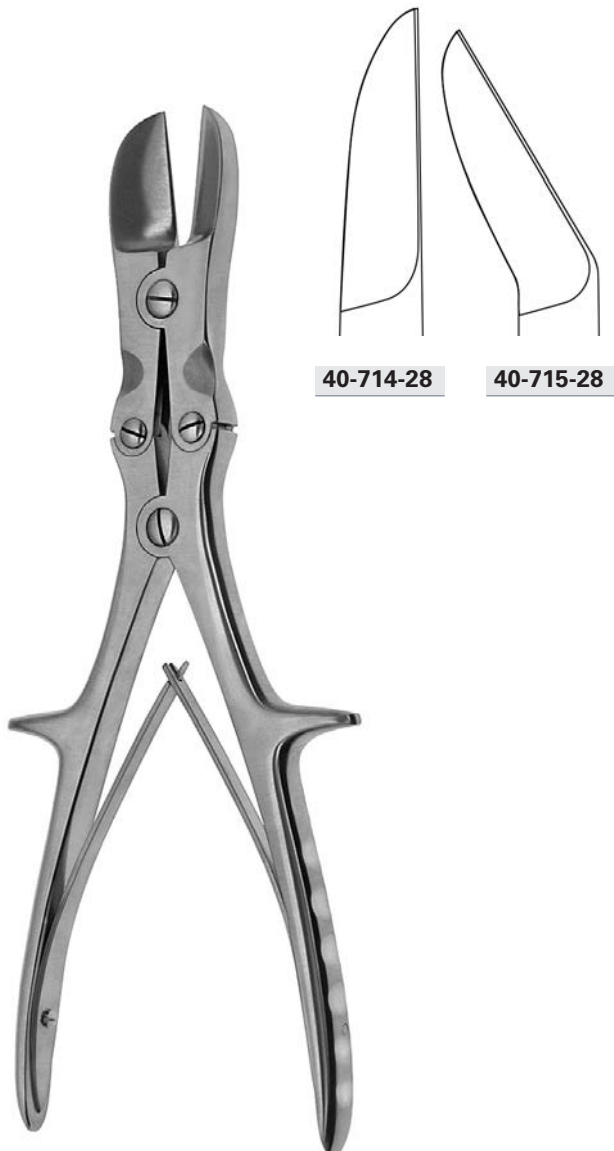

40-714-28

40-715-28

LISTON

40-714-28 - 40-715-28 28,0 cm, 11 "



40-717-27

LISTON-STILLE

40-717-27 27,0 cm, 10³/₄ "



40-719-27

LISTON-KEY

40-719-27 25,5 cm, 10 "



40-721-24

SEMB

40-721-24 24,0 cm, 9 ½ "

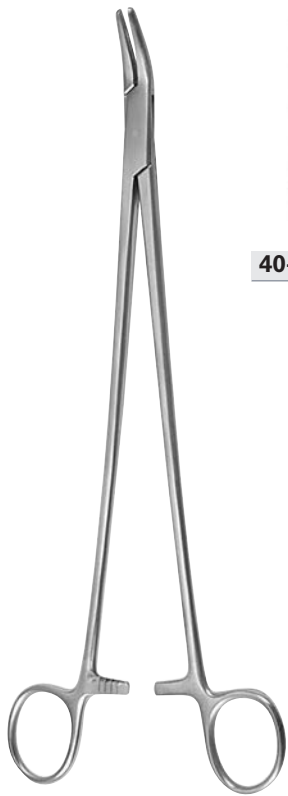

40-731-23



40-733-23

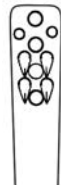

40-734-20



40-735-20

HERZ

40-731-23 23,0 cm, 9"

JAEGER

40-733-23 23,5 cm, 9 1/4"

BIRCHER

40-734-20 - 40-735-20 20,0 cm, 8"



40-737-20



40-739-19

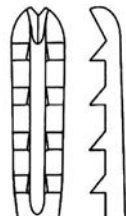

40-738-20

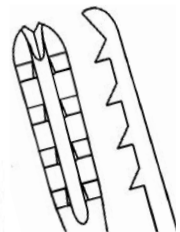
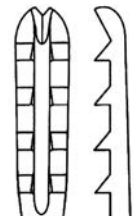

40-739-20

WELLER

40-737-20 20,0 cm, 8"

BIRCHER-GANSKE

40-739-19 20,0 cm, 8"

BIRCHER-GANSKE

40-738-20 - 40-739-20 20,0 cm, 8"



40-739-21

BIRCHER-GANSKE

40-739-21 20,0 cm, 8"



40-740-20

MARTIN

40-740-20 20,0 cm, 8"



40-741-14

40-741-14 14,5 cm, 5 1/2"



40-747-01

NEFF

40-747-01 21,5 cm, 8 1/2"



40-747-02

NEFF

40-747-02 21,5 cm, 8 1/2"



40-751-01

SALENIUS

40-751-01 22,0 cm, 8 3/4"



40-751-02

SALENIUS

40-751-02 22,0 cm, 8 3/4"



40-754-01

BIRCHER

40-754-01 19,0 cm, 7 1/2"



40-754-02

BIRCHER

40-754-02 19,0 cm, 7 1/2"



40-755-01

SMILLIE

40-755-01 - 40-755-03 17,0 cm, 6 3/4"

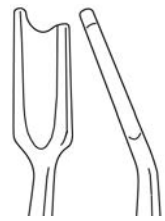
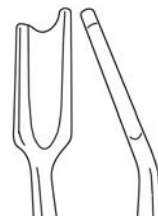

40-755-02

40-755-03



40-757-01

CANAD. MODELL

40-757-01 20,0 cm, 8"



40-757-02

CANAD. MODELL

40-757-02 20,0 cm, 8"





40-759-00 100 x 30 mm
40-759-75 75 x 30 mm

TAYLOR

40-759-00 - 40-759-75 16,5 cm, 6 1/4"

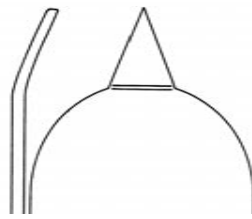

39,0 x 9,0 mm
40-761-22

BIRCHER

40-761-22 22,5 cm, 9"

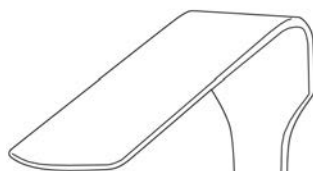

40-760-01 32 x 19 mm
40-760-02 48 x 19 mm
40-760-03 57 x 19 mm

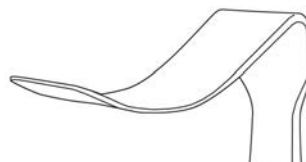

40-760-04 52 x 13 mm



40-760-05 12 x 13 mm
40-760-06 13 x 25 mm



SMILLIE

40-760-01 - 40-760-06 14,0 cm, 5 1/2"

SMILLIE

40-760-00 SET

komplett, bestehend aus: 40-760-01 - 40-760-06
complete, consisting of: 40-760-01 - 40-760-06
completo, compuesto de: 40-760-01 - 40-760-06
completo, composto da: 40-760-01 - 40-760-06



40,0 x 4,0 mm
40-762-17

56,0 x 10,0 mm
40-763-17

BLOUNT

BLOUNT

BLOUNT

40-762-17 17,5 cm, 7 "

40-762-26 26,0 cm, 10 ¼ "

40-762-27 26,0 cm, 10 ¼ "

40-763-17 17,0 cm, 6 ¾ "

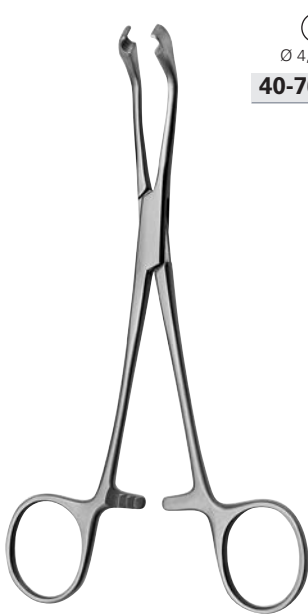

Ø 4,0 mm
40-767-04

Ø 5,0 mm
40-767-05

HERZ

40-767-04 - 40-767-05 15,5 cm, 6 "



40-768-15
4 x 5 Zähne
4 x 5 teeth
4 x 5 dientes
4 x 5 denti

JACKSON

40-768-15 15,0 cm, 6 "



40-770-15



40-771-15

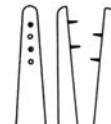

40-772-12



40-770-15 - 40-771-15 15,0 cm, 6 "



40-772-12 12,0 cm, 4 ¾ "



40-774-20

1 x 2 Zähne
 1 x 2 teeth
 1 x 2 dientes
 1 x 2 denti



40-775-20

1 x 2 Zähne
 1 x 2 teeth
 1 x 2 dientes
 1 x 2 denti



CAROLL

40-774-20 - 40-775-20 20,5 cm, 8"

40-777-11 11,0 cm, 4 3/8"



40-776-27 Ø 2,3 mm

flexibel
 flexible
 flexibles
 flessibili

mit Rohrschaft
 with tubular shaft
 con vástago tubular
 con asta tubolare

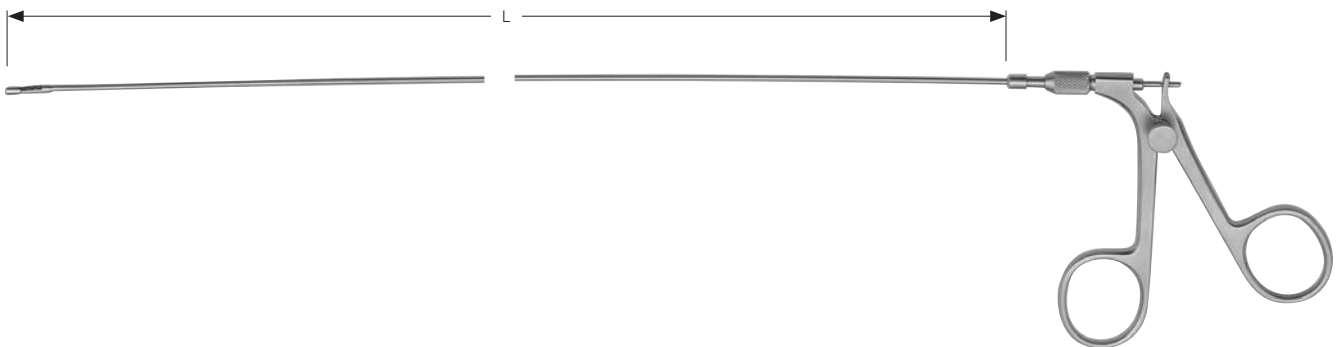

JAEGER

40-776-27 27,5 cm, 10 3/4"





40-778-15



40-778-18

BRAND

40-778-15	15,0 cm, 6 "
40-778-18	18,5 cm, 7 ¼ "



40-779-15



40-779-18

BRAND

40-779-15	15,0 cm, 6 "
40-779-18	18,5 cm, 7 ¼ "



40-780-20



Ø 2,0 mm
1 x 2 Zähne
1 x 2 teeth
1 x 2 dientes
1 x 2 denti

KLEINERT-KUTZ

40-780-20	20,5 cm, 8 "
------------------	--------------



40-788-03	Ø 3,5 mm
40-788-04	Ø 4,0 mm
40-788-05	Ø 5,0 mm
40-788-06	Ø 6,0 mm
40-788-09	Ø 9,0 mm

Sehenschäler
Tendon stripper
Mondador de tendones
Enucleatore per tendine

BUNNELL

40-788-03 - 40-788-09	15,0 cm, 6 "
------------------------------	--------------



40-789-40	Ø 4,0 mm
40-789-45	Ø 4,5 mm
40-789-55	Ø 5,5 mm

Sehenschäler, flexibler Schaft
Tendon stripper, flexible shaft
Mondador de tendones, vástago flexible
Enucleatore per tendine, gambo malleabile

40-789-40 - 40-789-55	23,0 cm, 9 "
------------------------------	--------------



Ø 5,0 mm
40-786-23
 biegsam
 malleable
 maleable
 malleabile



Ø 4,0 mm
40-782-31
 stumpf
 blunt
 romo
 smusso



Ø 3,0 mm
40-784-29



Ø 5,5 mm
40-790-00

BUNNELL

40-786-23 23,0 cm, 9"

FISCHER

40-782-31 31,0 cm, 12 ¼"

40-784-29 50,0 cm, 19 ¾"

40-790-00 33,5 cm, 13 ¼"

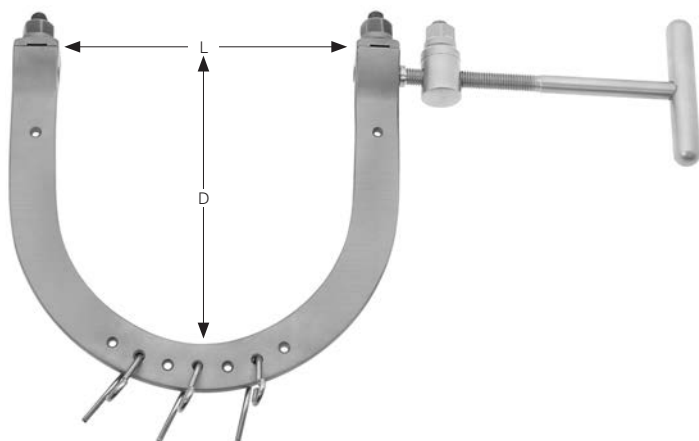

KIRSCHNER

40-801-00	60 x 60 mm
40-801-01	95 x 70 mm
40-801-02	95 x 110 mm
40-801-03	105 x 100 mm
40-801-04	120 x 120 mm
40-801-05	135 x 130 mm
40-801-06	155 x 155 mm
40-801-07	200 x 155 mm



KIRSCHNER

40-802-01	40 - 140 mm
40-802-03	60 - 220 mm



KIRSCHNER

40-803-01	0 - 130 mm
40-803-02	0 - 185 mm
40-803-03	0 - 220 mm

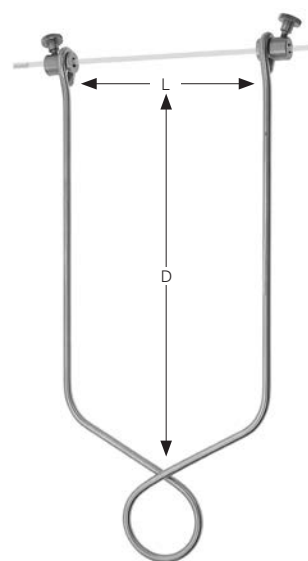

KIRSCHNER

40-804-01	90 x 160 mm
40-804-02	110 x 210 mm
40-804-03	150 x 210 mm

Spannschlüssel für 40-801-00 – 07
Wrench for 40-801-00 – 07
Tensor de taladros para 40-801-00 – 07
Chiave per mandrino per 40-801-00 – 07



40-805-00

Spannschlüssel
Wrench
Tensor de taladros
Chiave per mandrino



40-806-00 SW 14 | 17

Zughaken, groß
Traction hook, large
Gancho de tracción, grande
Ganci di trazione, grande



40-807-00

Zughaken, klein
Traction hook, small
Gancho de tracción, pequeño
Ganci di trazione, piccola



40-808-00

Fixierscheiben, paar
Fixation discs, pair
Discos fijadores, par
Dischi fissaggio, paio



40-809-00

Begrenzungsplatte
Fixation disc
Disco fijador
Disco fissaggio



40-810-00

Fig. 1

40-811-01

Drahtgeflecht, klein
Wire mesh, small
Malla de alambre, pequeño
Maglia metallica, piccola

Fig. 2

40-811-02

Drahtgeflecht, mittel
Wire mesh, medium
Malla de alambre, mediano
Maglia metallica, mezzo

Fig. 3

40-811-03

Drahtgeflecht, groß
Wire mesh, large
Malla de alambre, grande
Maglia metallica, grande



40-811-01 - 40-811-03 23,0 cm, 9"

Handbohrfutter und Spannschlüssel
40-816-97, längsdurchbohrt Ø 4,5 mm
Drilling chuck and key 40-816-97,
cannulated Ø 4,5 mm
Mandril de tres mordazas con clave
40-816-97, barrenado oblongo Ø 4,5 mm
Trapano con mandrino e chiave
40-816-97, tubolare Ø 4,5 mm

Handbohrfutter und Spannschlüssel
40-816-99, längsdurchbohrt Ø 6,0 mm
Drilling chuck and key 40-816-99,
cannulated Ø 6,0 mm
Mandril de tres mordazas con clave
40-816-99, barrenado oblongo Ø 6,0 mm
Trapano con mandrino e chiave
40-816-99, tubolare Ø 6,0 mm

Ø 0,8 - 1,6 mm



VICKERS

40-812-00 14,0 cm, 5 1/2"



40-813-00 Ø 0,5 - 7,0 mm



40-816-00 Ø 0,5 - 7,0 mm

AO Dreibackenspannfutter und
Spannschlüssel 40-816-99
AO Three jaw chuck and key 40-816-99
AO Tres de sujeción del portabrocas con
clave 40-816-99
AO Mandrino a tre ganasce e chiave
40-816-98

AO Dreibackenspannfutter und
Spannschlüssel 40-918-99
AO Three jaw chuck and key 40-918-99
AO Tres de sujeción del portabrocas con
clave 40-918-99
AO Mandrino a tre ganasce e chiave
40-918-98

AO Dreibackenspannfutter und
Spannschlüssel 40-816-99
AO Three jaw chuck and key 40-816-99
AO Tres de sujeción del portabrocas con
clave 40-816-99
AO Mandrino a tre ganasce e chiave
40-816-98



40-817-00 Ø 0,5 - 7,0 mm



40-817-01 Ø 0,0 - 4,0 mm



40-818-00 Ø 0,5 - 7,0 mm



T - Handbohrfutter, längsdurchbohrt Ø 6,0 mm
 T - drilling chuck, cannulated Ø 6,0 mm
 T - mandril de tres mordazas, barrenado oblongo Ø 6,0 mm
 T - trapano con mandrino, tubolare Ø 6,0 mm

T - Handbohrfutter, verriegelbar, längsdurchbohrt Ø 6,0 mm
 T - drilling chuck, lockable, cannulated Ø 6,0 mm
 T - mandril de tres mordazas, bloqueado, barrenado oblongo Ø 6,0 mm
 T - trapano con mandrino, bloccato, tubolare Ø 6,0 mm

T - Handbohrfutter, verriegelbar, längsdurchbohrt Ø 6,0 mm
 T - drilling chuck, lockable, cannulated Ø 6,0 mm
 T - mandril de tres mordazas, bloqueado, barrenado oblongo Ø 6,0 mm
 T - trapano con mandrino, bloccato, tubolare Ø 6,0 mm



40-819-00 Ø 1,0 - 6,0 mm



40-820-00 Ø 1,0 - 6,0 mm



40-820-10 Ø 1,0 - 6,0 mm



Cerlage Draht, weich, 10m
 Bone wire, soft, 10 m
 Hilos de cerlaje, blando, 10 m
 Filo per ossa, malleabile, 10 m



Cerlage Draht, weich, 10m
 Bone wire, soft, 10 m
 Hilos de cerlaje, blando, 10 m
 Filo per ossa, malleabile, 10 m



Durchmesser Diameter Diámetro Diámetro	
Ø 0,2 mm	40-821-02
Ø 0,3 mm	40-821-03
Ø 0,4 mm	40-821-04
Ø 0,5 mm	40-821-05
Ø 0,6 mm	40-821-06
Ø 0,7 mm	40-821-07
Ø 0,8 mm	40-821-08
Ø 0,9 mm	40-821-09
Ø 1,0 mm	40-821-10
Ø 1,2 mm	40-821-12
Ø 1,5 mm	40-821-15
Ø 1,8 mm	40-821-18
Ø 2,0 mm	40-821-20

Durchmesser Diameter Diámetro Diámetro	
Ø 0,2 mm	
Ø 0,3 mm	
Ø 0,4 mm	
Ø 0,5 mm	
Ø 0,6 mm	
Ø 0,7 mm	
Ø 0,8 mm	40-821-08 T
Ø 0,9 mm	
Ø 1,0 mm	40-821-10 T
Ø 1,2 mm	40-821-12 T
Ø 1,5 mm	40-821-15 T
Ø 1,8 mm	
Ø 2,0 mm	



LOUTE

40-822-22 21,5 cm, 8 ½"



DEMEL

40-824-27 27,0 cm, 10 ¾"



40-824-09 9,0 cm, 3 ½"



DEMEL

40-825-01 27,5 cm, 10 ¾"
40-825-02 28,5 cm, 11 ¼"
40-825-03 30,5 cm, 12"

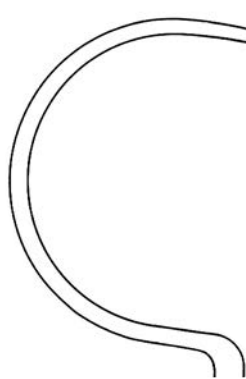

40-825-01

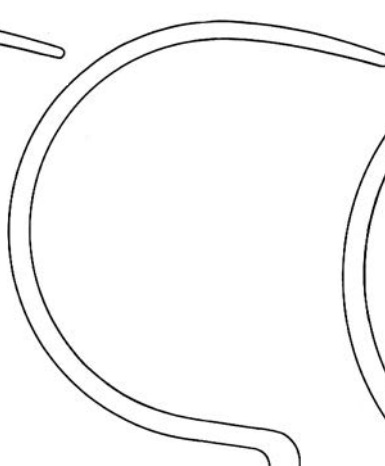

40-825-02

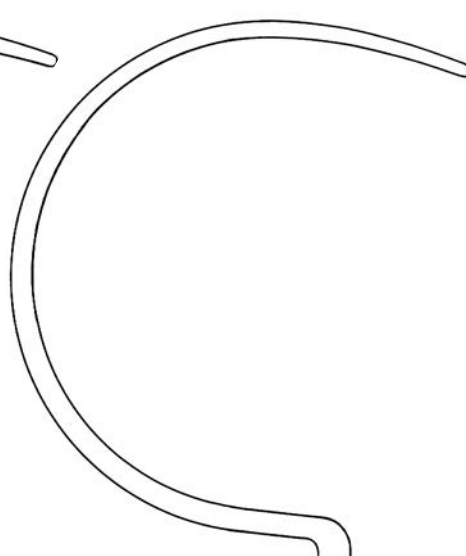

40-825-03



40-826-01

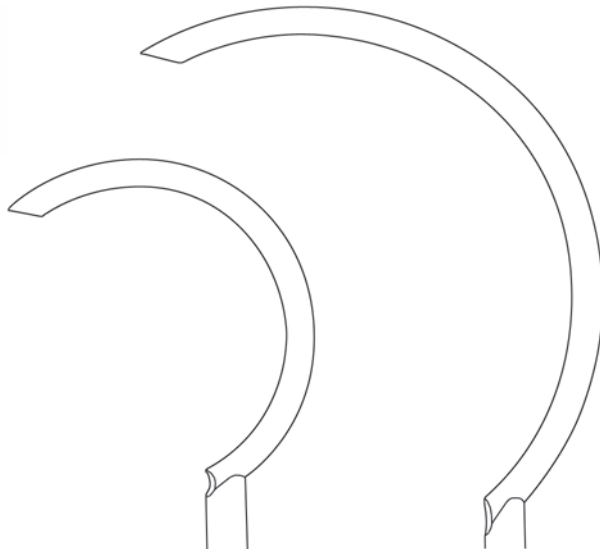

40-826-02



40-827-01

40-826-01 24,0 cm, 9 1/2 "
 40-826-02 27,0 cm, 10 3/4 "

40-827-01 22,5 cm, 9 "



40-828-20



40-830-15



40-830-18



BAUMGARTNER

40-828-20 20,0 cm, 8 "

40-830-15 15,0 cm, 6 "

40-830-18 18,0 cm, 7 "

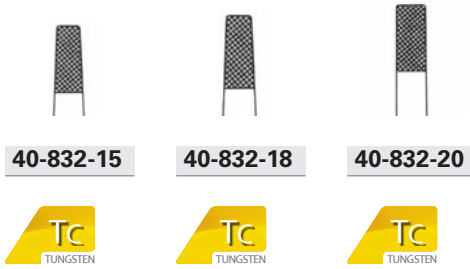
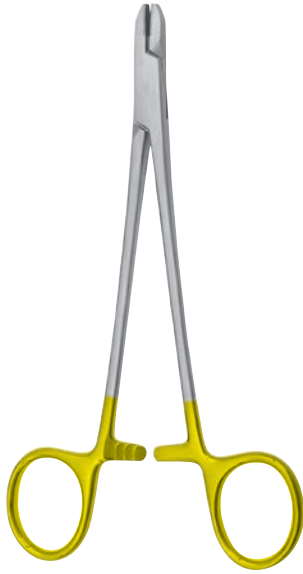

40-832-15

40-832-18

40-832-20



40-832-15	15,0 cm, 6"
40-832-18	18,0 cm, 7"
40-832-20	20,0 cm, 8"

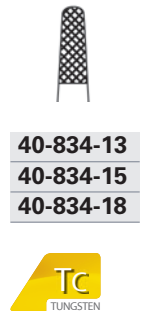
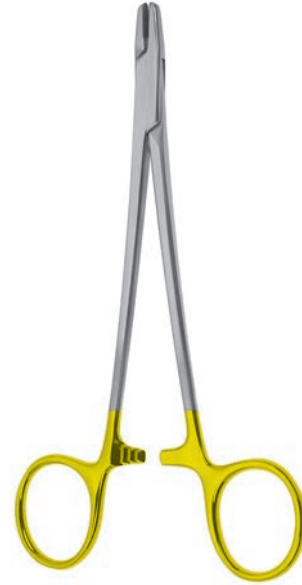

40-834-13
40-834-15
40-834-18



40-834-13	15,0 cm, 5 1/8"
40-834-15	15,0 cm, 6"
40-834-18	18,0 cm, 7"

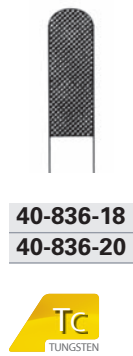

40-836-18
40-836-20



40-836-18	18,5 cm, 7 1/4"
40-836-20	20,0 cm, 8"

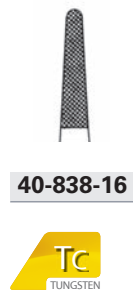

40-838-16



CORWIN

40-838-16	16,0 cm, 6 1/4"
-----------	-----------------

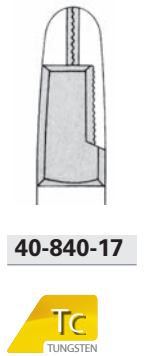

40-840-17



40-840-17	17,0 cm, 6 3/4"
-----------	-----------------



40-850-14



40-850-14 14,0 cm, 5 1/2"

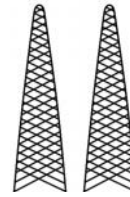

40-851-01

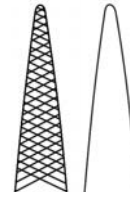

40-851-02

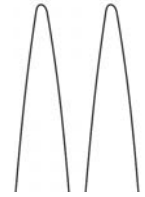

40-851-03



40-851-01 - 40-851-03 14,0 cm, 5 1/2"

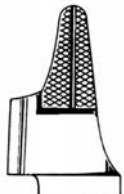

40-852-15



40-852-15 15,0 cm, 6"



40-852-16



40-852-16 16,0 cm, 6 1/4"



40-854-01



40-854-02



40-854-01 - 40-854-02 17,0 cm, 6 3/4"

HACKSTOCK



40-854-03

40-854-03 19,0 cm, 7 1/2"



40-856-17

40-856-17 17,0 cm, 6 3/4"



40-858-17 18,0 cm, 8"



40-858-18 18,0 cm, 7"
40-858-20 20,0 cm, 8"
40-858-24 24,0 cm, 9 1/2"



40-860-13 13,0 cm, 5 1/8"
40-860-18 18,0 cm, 8"



40-862-01
40-862-11

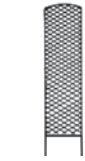

40-862-02



40-862-03



40-864-18

40-862-01 14,5 cm, 5 3/4 "
40-862-02 - 40-862-11 18,0 cm, 7 "

40-864-18 18,0 cm, 7 "



40-863-01



40-863-02



40-863-03



40-863-01 - 40-863-03 18,0 cm, 7 "

40-865-00 < Ø 1,8 mm



1,0 mm 1,5 mm
40-868-14



40-868-14 14,0 cm, 5 1/2"



1,0 mm 1,5 mm
40-870-15



40-870-15 15,0 cm, 6"



1,2 mm 1,5 mm
40-872-16



40-872-16 16,0 cm, 6 1/4"



1,7 mm 2,0 mm
40-873-16
40-873-18



40-873-16 16,0 cm, 6 1/4"
40-873-18 18,0 cm, 7"

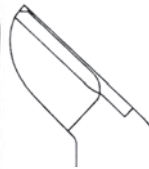

2,2 mm 3,0 mm
40-873-22



40-873-22 22,0 cm, 8 3/4"



1,5 mm 2,0 mm
40-874-17



REILL

40-874-17 17,5 cm, 7"

Drahtkniefzangen
Wire cutting forceps
Alicates corta-alambres
Tenaglie tagliafili

max. Ø

harte Drähte
hard wires
alambres duros
fili duri

max. Ø

weiche Drähte
soft wires
alambres blandos
fili molli



40

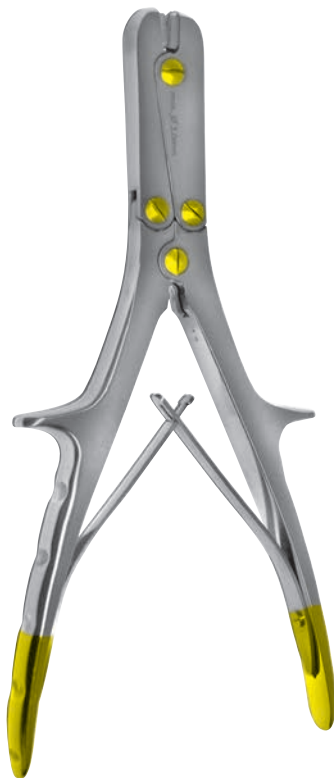

3,0 mm 3,0 mm
40-873-25



Kunststoffbacken halten den Draht nach dem Durchtrennen in der Zange fest.

Plastic inserts hold wire piece after being cut.

Mordazas de plástico retienen el alambre después del corte.

Le guance di plastica sostengono il filo nel morso della pinza dopo il taglio.



2,2 mm
40-875-18



40-873-25 25,0 cm, 9 3/4 "

40-875-18 18,0 cm, 7 "



3,0 mm
40-875-23



4,0 mm
40-875-28



Ersatzteilset
Spare part set
Juego de pieza de repuesto
Set di pezzo di ricambio



40-875-88 => 40-875-18
40-875-89 => 40-875-23
40-875-90 => 40-875-28

Ersatzteilset für 40-875-18 - 28
Spare part set for 40-875-18 - 28
Juego de pieza de repuesto 40-875-18 - 28
Set di pezzo di ricambio 40-875-18 - 28



40-875-23 23,0 cm, 9 "

40-875-28 28,0 cm, 11 "

40-875-91 SET



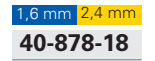
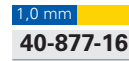
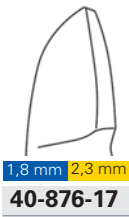

längsdurchbohrt
cannulated
barrenado oblongo
tubolare

40-876-17 17,0 cm, 6 3/4"
40-876-23 23,5 cm, 9 1/4"

40-877-16 16,0 cm, 6 1/4"

40-878-18 18,0 cm, 7"

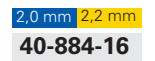
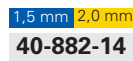

40-880-14 14,5 cm, 5 3/4"

40-882-14 14,5 cm, 5 3/4"

40-884-16 16,0 cm, 6 1/4"

Drahtkneifzangen
Wire cutting forceps
Alicates corta-alambres
Tenaglie tagliafili

max. Ø

harte Drähte
hard wires
alambres duros
fili duri

max. Ø

weiche Drähte
soft wires
alambres blandos
fili molli



40



1,5 mm 2,0 mm
40-886-18

Tc
TUNGSTEN

40-886-18 18,0 cm, 7 "



1,6 mm
40-887-18

Tc
TUNGSTEN

40-887-18 18,0 cm, 7 "

Ersatzteilset
Spare part set
Juego de pieza de repuesto
Set di pezzo di ricambio



40-887-90 => 40-887-18



2,0 mm 3,0 mm
40-888-22

Tc
TUNGSTEN

40-888-22 22,0 cm, 8 ¾ "



3,0 mm 3,0 mm
40-889-02

Tc
TUNGSTEN

40-889-02 17,0 cm, 6 ¾ "

Ersatzteilset
Spare part set
Juego de pieza de repuesto
Set di pezzo di ricambio



40-889-98 => 40-889-02

Ersatzteilset
Spare part set
Juego de pieza de repuesto
Set di pezzo di ricambio



40-889-99 => 40-889-02



40-890-23 23,0 cm, 9"



6,0 mm
40-890-47
40-890-54



6,0 mm
40-890-58



6,0 mm
40-890-48



Griffe abnehmbar
Removable handles
Mangos desmontables
Manici smontabili

6,0 mm
40-890-57

Griffe abnehmbar
Removable handles
Mangos desmontables
Manici smontabili

40-890-47 47,0 cm, 18 1/4"
40-890-54 56,0 cm, 22"
40-890-58 58,0 cm, 23"

40-890-48 48,0 cm, 18 3/4"
40-890-57 57,0 cm, 22 1/2"

Drahtkneifzangen
Wire cutting forceps
Alicates corta-alambres
Tenaglie tagliafili

max. Ø

harte Drähte
hard wires
alambres duros
fili duri

max. Ø

weiche Drähte
soft wires
alambres blandos
fili molli



40

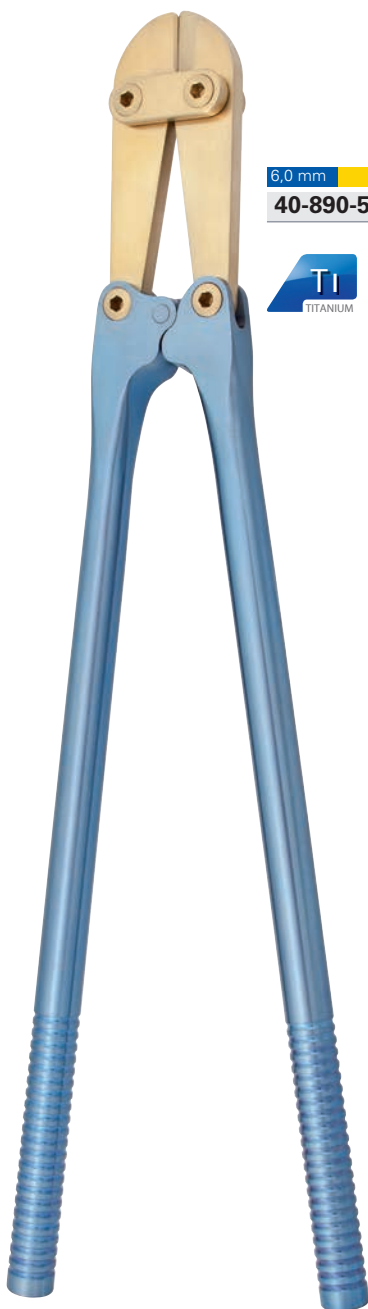

6,0 mm

40-890-54 T



2,5 mm 3,2 mm

40-891-26

3,2 mm 4,0 mm

40-891-38



3,2 mm 4,7 mm

40-891-39



40-890-54 T 54,0 cm, 21 1/2"

40-891-26 26,0 cm, 10 3/8"

40-891-38 38,0 cm, 15"

40-891-39 38,0 cm, 15"



www.AMNOTEC.de

1169

max. Ø

harte Drähte
 hard wires
 alambres duros
 fili duri

max. Ø

weiche Drähte
 soft wires
 alambres blandos
 fili molli

3,0 mm

40-892-32



< Ø 3,0 mm



< Ø 3,0 mm



< Ø 2,7 mm



PF
 FERROZELL

PP
 PROPYLUX

WAGNER

WAGNER

40-892-32 32,0 cm, 12 3/4"

40-894-12 12,0 cm, 4 3/4"

40-896-30 30,0 cm, 11 3/4"

40-896-30 P 30,0 cm, 11 3/4"

komplett, mit einem Satz Bohrer 40-910-01
complete, with a set of drills 40-910-01
completo, con un juego de brocas 40-910-01
completo, con una serie di punte 40-910-01



MOORE

40-910-00 27,5 cm, 10 7/8"

40-910-01 SET

komplett, mit einerm Satz Bohrer 40-911-01 - 03
complete, with a set of drills 40-911-01 - 03
completo, con un juego de brocas 40-911-01 - 03
completo, con una serie di punte 40-911-01 - 03



STILLE-SHERMAN

40-911-00 25,0 cm, 9 7/8"

40-911-01

40-911-02

komplett, mit einem Satz Bohrer 40-912-10 - 18
complete, with a set of drills 40-912-10 - 18
completo, con un juego de brocas 40-912-10 - 18
completo, con una serie di punte 40-912-10 - 18



STILLE

40-912-00 20,0 cm, 8"

Handbohrapparat
Hand drill
Perforador de mano
Trapano a mano per ossa

40-912-01

Ø 2,5 mm

40-912-10

Ø 3,0 mm

40-912-11

Ø 3,5 mm

40-912-12

Ø 4,0 mm

40-912-13

Ø 10,0 mm

40-912-14

Ø 5,0 mm

40-912-15

Ø 8,0 mm

40-912-16

Ø 12,0 mm

40-912-17

Ø 16,0 mm

40-912-18

komplett, mit einem Satz Bohrer 40-916-01 - 04 | 09
complete, with a set of drills 40-916-01 - 04 | 09
completo, con un juego de brocas 40-916-01 - 04 | 09
completo, con una serie di punte 40-916-01 - 04 | 09

Verlängerungsstück
Extension Piece
Pieza de prolongación
Giunto di prolungamento



HUDSON

40-916-00 28,0 cm, 11 "

Handbohrapparat
Hand drill
Perforador de mano
Trapano a mano per ossa

40-916-10



40-916-09



Ø 9,0 mm

40-916-01



Ø 14,0 mm

40-916-02



Ø 16,0 mm

40-916-03



Ø 22,0 mm

40-916-04



Ø 13,0 mm

40-916-05



Ø 2,4 mm

40-916-06



Ø 13,0 mm

40-916-07



Ø 15,0 mm

40-916-08

Handbohrapparat und Spannschlüssel 40-918-99
Hand drill and key 40-918-99
Perforador de mano con llave 40-918-99
Trapano a mano per ossa e chiave 40-918-99



BUNNELL

40-918-00

Handbohrapparat und Spannschlüssel 40-816-99
Hand drill and key 40-816-99
Perforador de mano con llave 40-816-99
Trapano a mano per ossa e chiave 40-816-99



RALK

40-919-00

Handbohrapparat und Spannschlüssel 40-816-99
Hand drill and key 40-816-99
Perforador de mano con llave 40-816-99
Trapano a mano per ossa e chiave 40-816-99

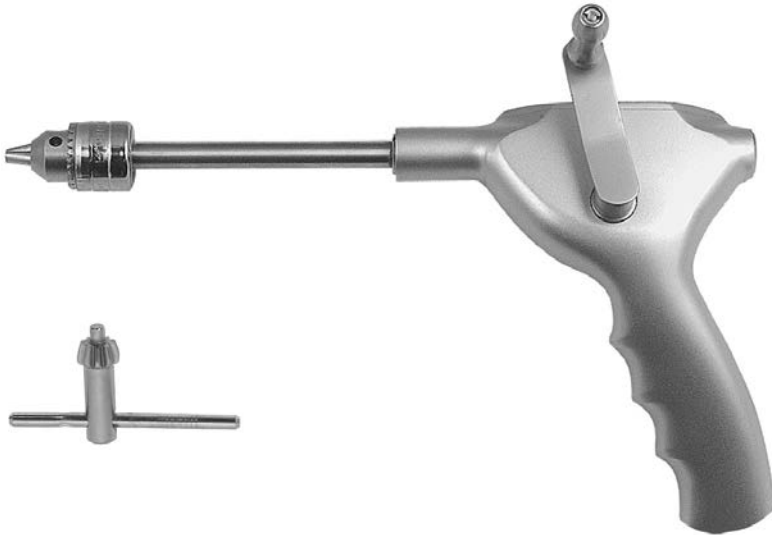

RALK

40-919-01

Handbohrapparat und Spannschlüssel 40-816-98
Hand drill and key 40-816-98
Perforador de mano con llave 40-816-98
Trapano a mano per ossa e chiave 40-816-98



40-920-00



42/43/44

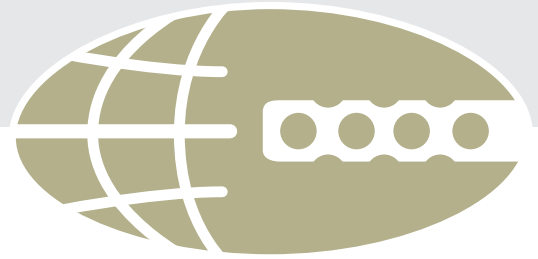

Osteosythese

Osteosynthesis

Osteosíntesis

Osteosintesi

Fordern Sie unser Spezialprospekt an
Please ask for our special catalogue
No duden pedirnos más catálogos especiales
Chiedete i nostri cataloghi speciali



47



Hand- und Fuß Chirurgie

Hand and foot Surgery

Cirugía de mano y pie

Chirurgia della mano e piede



47-001-13

MANNERFELT

47-001-13 13,5 cm, 5 1/4"



47-001-15

MANNERFELT

47-001-15 15,5 cm, 6 1/8"



3,5 x 12,0 mm
47-003-15

MANNERFELT

47-003-15 15,5 cm, 6 1/8"

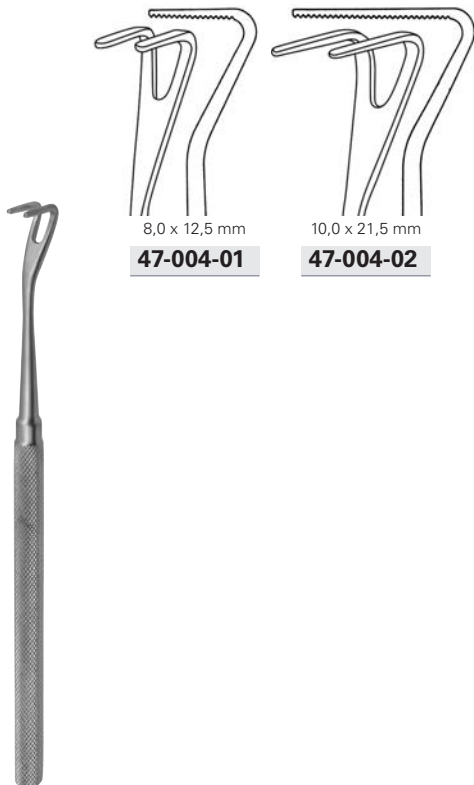

8,0 x 12,5 mm
47-004-01

10,0 x 21,5 mm
47-004-02

MANNERFELT

47-004-01 - 47-004-02 15,5 cm, 6 1/8"

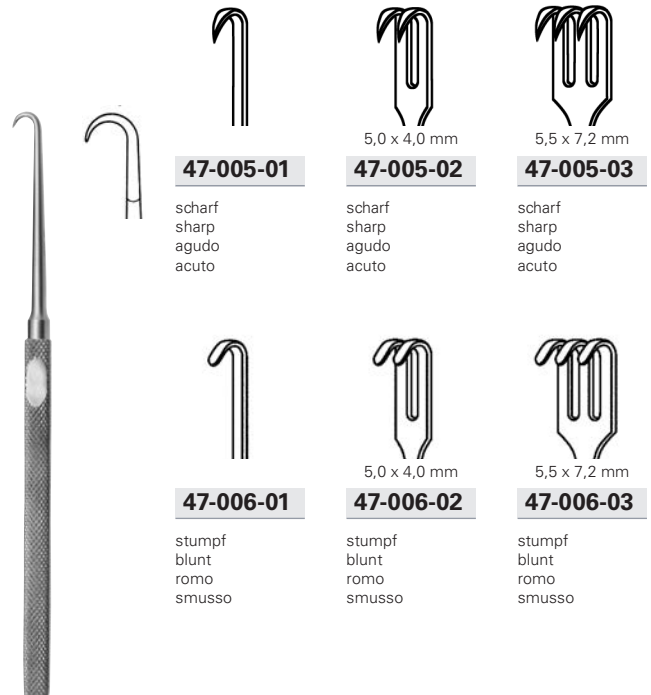

47-005-01

scharf
sharp
agudo
acuto

47-005-02

scharf
sharp
agudo
acuto

47-005-03

scharf
sharp
agudo
acuto

47-006-01

stumpf
blunt
romo
smusso

47-006-02

stumpf
blunt
romo
smusso

47-006-03

stumpf
blunt
romo
smusso

MANNERFELT

47-005-01 - 47-006-03 15,5 cm, 6 1/8"

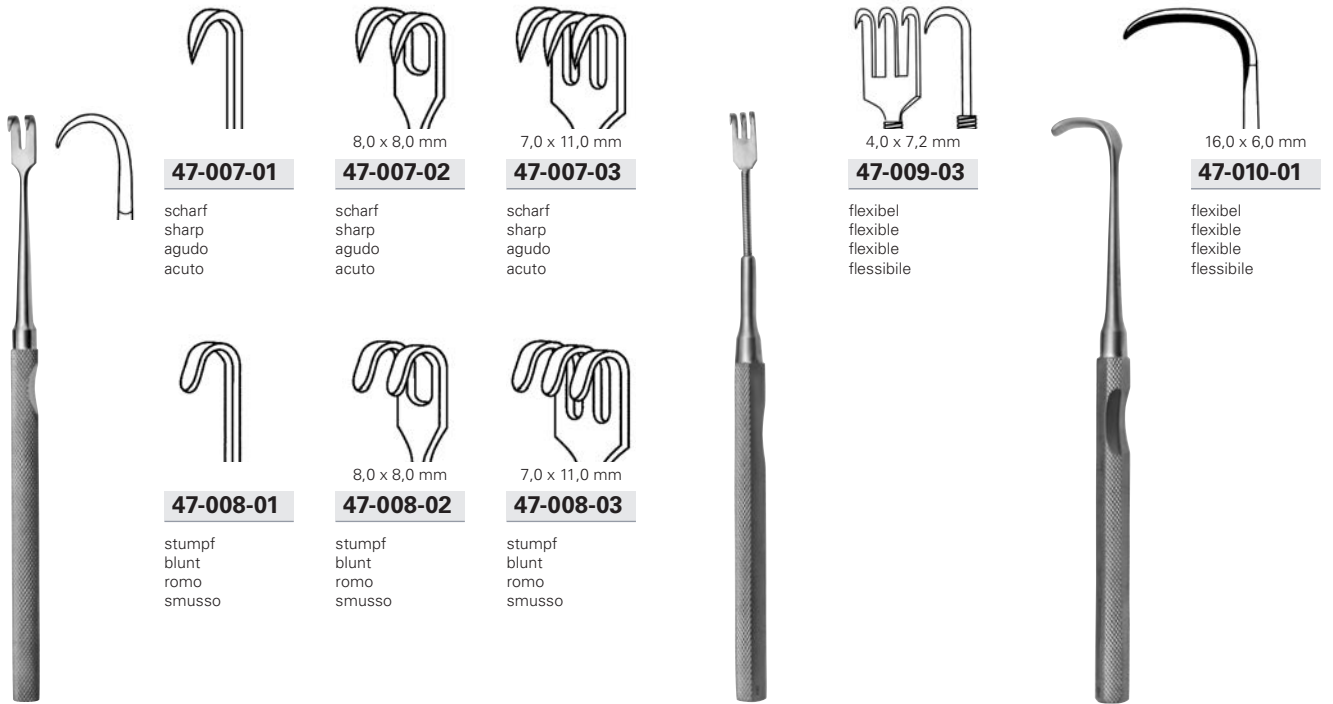

MANNERFELT

47-007-01 - 47-008-03 15,5 cm, 6 1/8"

MANNERFELT

47-009-03 15,5 cm, 6 1/8"

MANNERFELT

47-010-01 15,5 cm, 6 1/8"

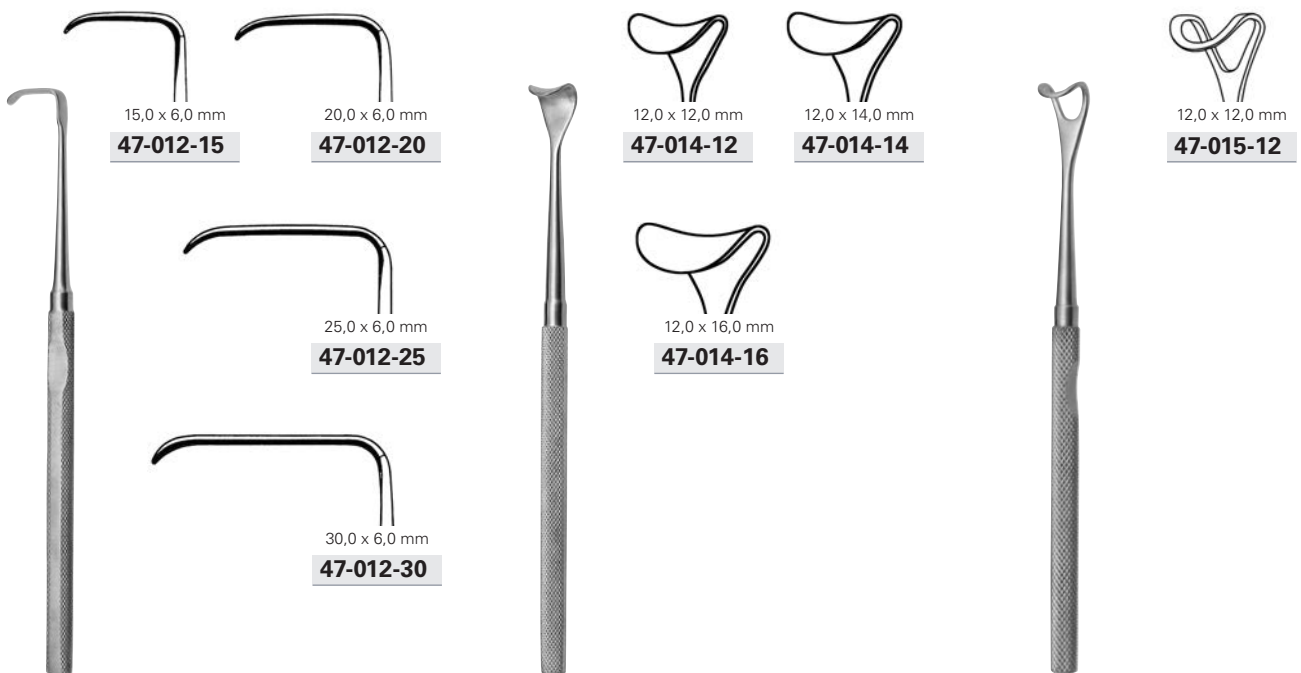

MANNERFELT

47-012-15 - 47-012-30 15,5 cm, 6 1/8"

MANNERFELT

47-014-12 - 47-014-16 15,5 cm, 6 1/8"

MANNERFELT

47-015-12 15,5 cm, 6 1/8"

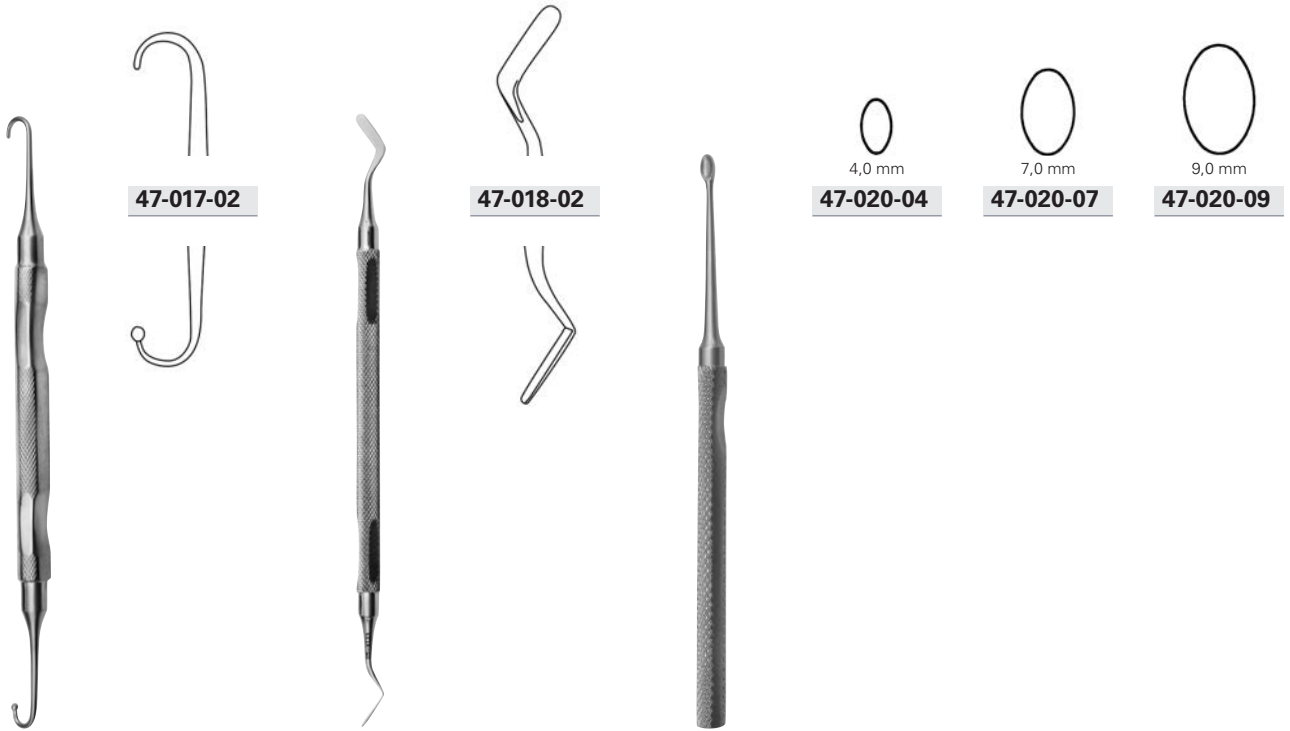

MANNERFELT

47-017-02 16,0 cm, 6 1/4"

MANNERFELT

47-018-02 16,0 cm, 6 1/4"

MANNERFELT

47-020-04 - 47-020-09 15,5 cm, 6 1/8"

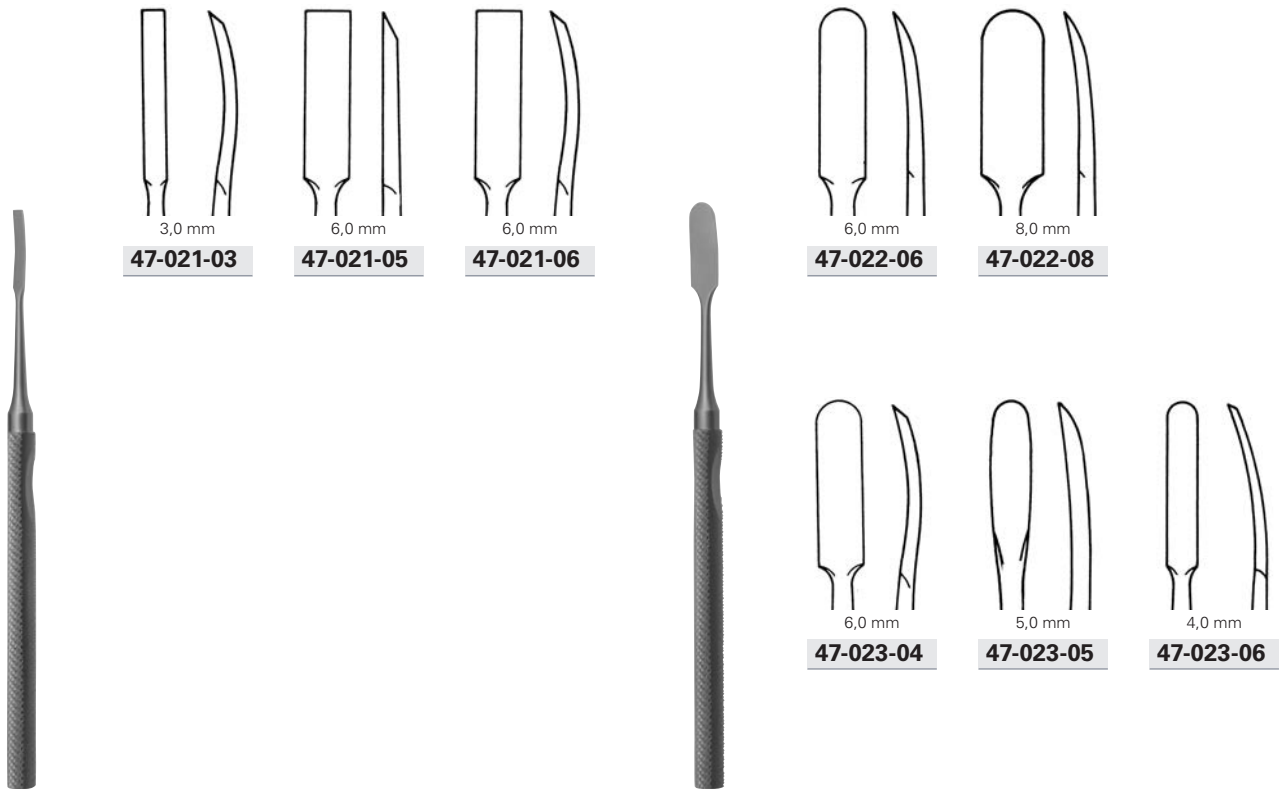

MANNERFELT

47-021-03 - 47-021-06 15,5 cm, 6 1/8"

MANNERFELT

47-022-06 - 47-023-06 15,5 cm, 6 1/8"

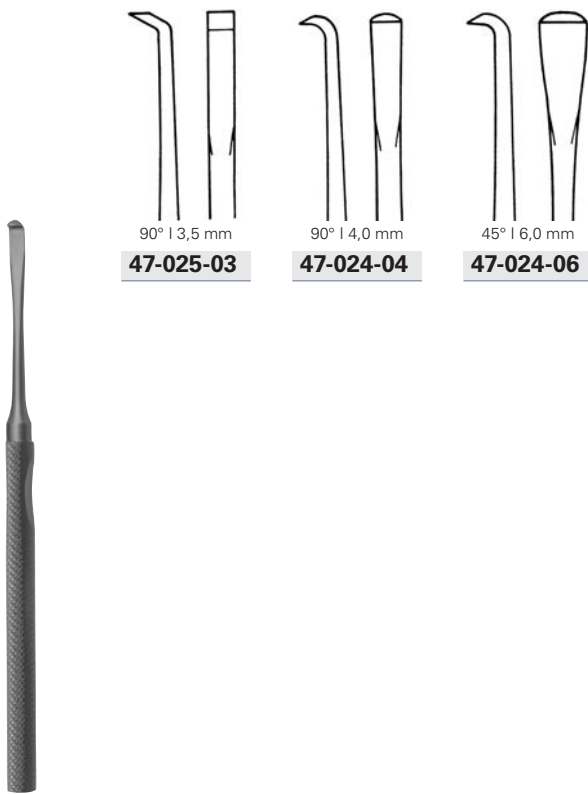

90° | 3,5 mm
47-025-03

90° | 4,0 mm
47-024-04

45° | 6,0 mm
47-024-06

MANNERFELT

47-024-04 - 27-025-03 15,5 cm, 6 1/8"

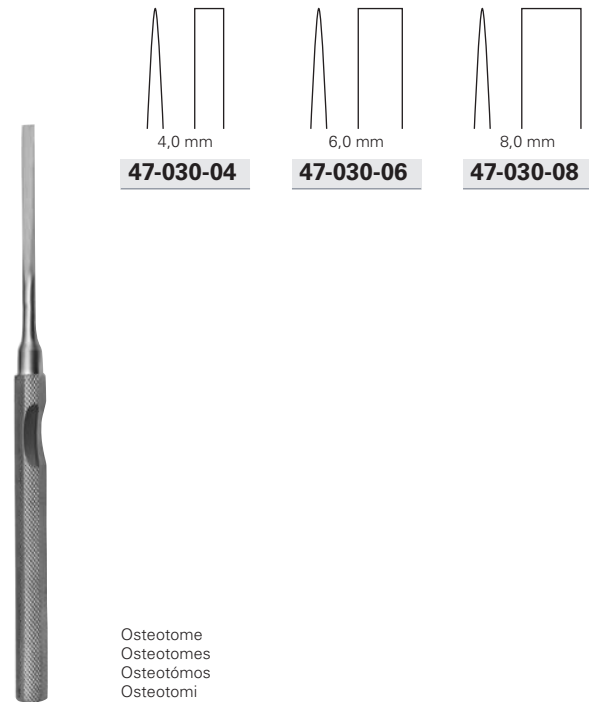

4,0 mm
47-030-04

6,0 mm
47-030-06

8,0 mm
47-030-08

Osteotome
 Osteotomes
 Osteótomos
 Osteotomi

MANNERFELT

47-030-04 - 47-030-08 15,5 cm, 6 1/8"



3,0 mm
47-032-03

Hohlmeißel
 Gouge
 Gubias
 Sgorbie

MANNERFELT

47-032-03 15,5 cm, 6 1/8"



Kompressorium
 Tourniquet
 Compresor
 Compressorio

FELDHEIM

47-210-00 10,0 cm, 4"



47-212-00 37,0 cm, 14 1/2 "

für Erwachsene
for adults
para adultos
per adulti

47-214-00 24,5 cm, 9 2/3 "

für Kinder
for children
para niños
per bambini

Bleihände: Durch Umbiegen der Lappen werden Hand und Finger in Operationslage festgehalten und durch das Gewicht der Bleihand zusätzlich immobilisiert.

Lead hands: Hand and fingers are secured by bending the lateral fixation process and further fixed by weight of lead hand.

Manos de plomo: Doblando los lóbulos se sujeta la mano y los dedos en posición para operar, y se queda también inmóvil por el peso de la mano de plomo.

Mano di piombo: Legando i lobi, la mano e le dita si assestano in posizione da poter operare grazie al peso della mano di piombo.

Gummiring
Rubber ring
Anillos de goma
Anelli di gomma



47-212-99 Ø 30,0 mm



VICKERS

47-216-00 25,0 cm, 10 "

Handhalter: Schnelles und sicheres Fixieren von Hand, Daumen und Fingern. Finger können seitlich nicht entweichen. Mehrfache Halterungen für Gummiband-Retraktoren.

Hand restrainer: Rapid application and release hand, thumb and individual fingers. Digits cannot escape sideways. Multipoint rubber band anchorages for varied postures.

Sujetador de mano: Aplicación rápida y segura de la mano, del pulgar y de los dedos. Los dedos no se pueden escapar lateralmente. Fijadores múltiples para retractores de cintas elásticas.

Supporto-mano: Di rapida applicazione e di sollievo per la mano, pollice e dita individuali. Le dita non possono andare lateralmente munito di varie fasce di gomma per l'ancoraggio in diverse posizioni.

Hand- und Karpaltunnel-Wundspreizer,
mit Mittelvalve 10 x 18 mm 47-224-01

Hand and carpal tunnel retractor,
with central valve 10 x 18 mm 47-224-01

Separador de mano y túnel de carpo,
con valva central 10 x 18 mm 47-224-01

Divaricatore per la mano con condotto
carpale, con valva centrale 10 x 18 mm
47-224-01



VICKERS

47-221-00 7,5 cm, 3"

Hand- und Unterarm-Wundspreizer,
mit Mittelvalve 10 x 18 mm 47-224-01

Deep hand and forearm retractor,
with central valve 10 x 18 mm 47-224-01

Separador profundo para mano y antebra-
zo, con valva central 10 x 18 mm 47-224-01

Divaricatore per la mano e l'avambraccio,
con valva centrale 10 x 18 mm 47-224-01



VICKERS

47-222-00 9,0 cm, 3 1/8"

Schnellender Finger- und Schnitt-
Wundspreizer, mit Mittelvalve 10 x 18 mm
47-224-01

Trigger finger and small wound retractor,
with central valve 10 x 18 mm 47-224-01

Separador para dedos y pequeñas heridas,
con valva central 10 x 18 mm 47-224-01

Impugnatura a molla per dita e piccolo
divaricatore per ferite, con valva centrale
10 x 18 mm 47-224-01



VICKERS

47-223-00 7,5 cm, 3"

Mittelvalve
Central valve
Valva central
Valva centrale

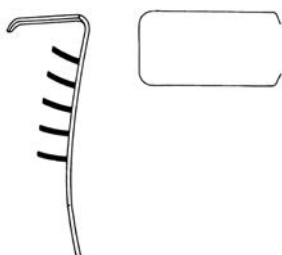

VICKERS

47-224-01 10 x 18 mm

Mittelvalve
Central valve
Valva central
Valva centrale

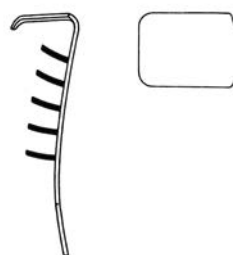

VICKERS

47-224-02 10 x 12 mm

Finger-Wundspreizer
Finger retractor
Separador para dedos
Divaricatore per dita



VICKERS

47-225-00 5,0 cm, 2"

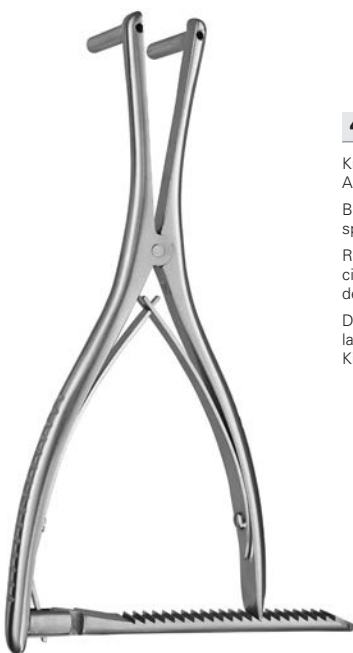

HINTERMANN

47-250-17 17,0 cm, 6 3/4 "



< Ø 2,0 mm

47-250-17

Knochen- und Gelenkspreizer zum
Aufspreizen über Kirschner Drähte
Bone and joint spreader for
spreading over Kirschner wires
Retradores de huesos y articula-
ciones para la separación a través
de agujas de Kirschner
Divaricatore per ossa e artico-
lazione da utilizzare con filo di
Kirschner



HINTERMANN

47-250-25 25,0 cm, 9 3/4 "



< Ø 2,0 mm

47-250-25

Knochen- und Gelenkspreizer zum
Aufspreizen über Kirschner Drähte
Bone and joint spreader for
spreading over Kirschner wires
Retradores de huesos y articula-
ciones para la separación a través
de agujas de Kirschner
Divaricatore per ossa e artico-
lazione da utilizzare con filo di
Kirschner



48



Gips- und
Verbandinstrumente

Plaster and
Dressing Instruments

Instrumentos para
vendajes y yeso

Strumenti per
bendaggi e gessature



SMITH

48-000-20	20,0 cm, 8 "
48-000-23	23,0 cm, 9 "



48-001-31	31,0 cm, 12 ¼ "
------------------	-----------------



LANGE

48-002-18	18,0 cm, 7 "
------------------	--------------

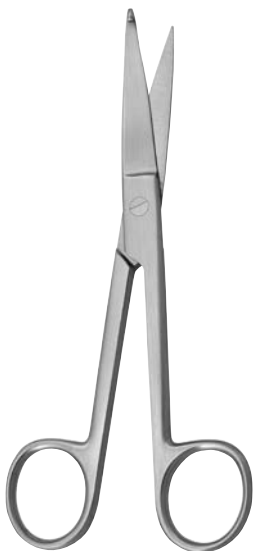

KNOWLES

48-005-14	14,0 cm, 5 ½ "
------------------	----------------



KNOWLES

48-006-14	14,0 cm, 5 ½ "
------------------	----------------

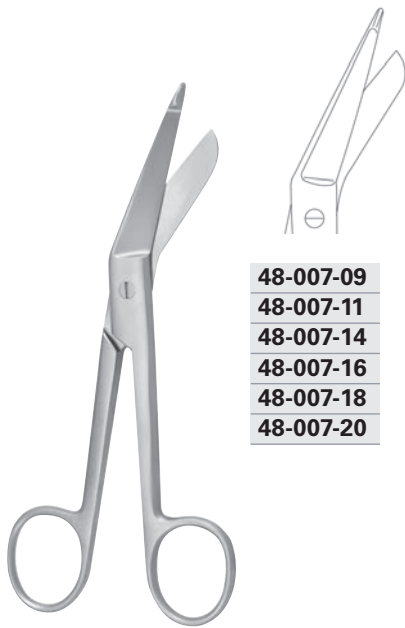

48-007-09
48-007-11
48-007-14
48-007-16
48-007-18
48-007-20



48-007-14 L
48-007-18 L
48-007-20 L

für die linke Hand
 left handed
 para la mano izquierda
 per la mano sinistra



48-007-14 SC
48-007-18 SC
48-007-20 SC



LISTER

48-007-09	9,0 cm, 3 1/2 "
48-007-11	11,0 cm, 3 3/8 "
48-007-14	14,0 cm, 5 1/2 "
48-007-16	16,0 cm, 6 1/4 "
48-007-18	18,0 cm, 7 "
48-007-20	20,0 cm, 8 "

LISTER

48-007-14 L	14,0 cm, 5 1/2 "
48-007-18 L	18,0 cm, 7 "
48-007-20 L	20,0 cm, 8 "

LISTER

48-007-14 SC	14,0 cm, 5 1/2 "
48-007-18 SC	18,0 cm, 7 "
48-007-20 SC	20,0 cm, 8 "

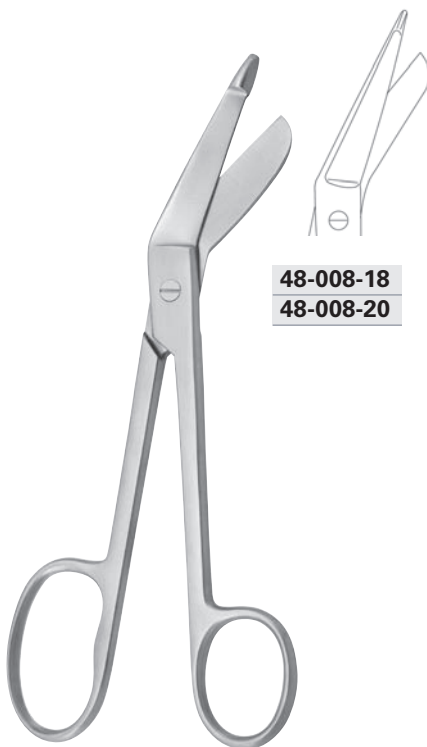

48-008-18
48-008-20



48-008-20 SC



48-009-14
48-009-18
48-009-20



LISTER

48-008-18	18,0 cm, 7 "
48-008-20	20,0 cm, 8 "

LISTER

48-008-20 SC	20,0 cm, 8 "
---------------------	--------------

LISTER

48-009-14	14,0 cm, 5 1/2 "
48-009-18	18,0 cm, 7 "
48-009-20	20,0 cm, 8 "

MICK Verband- und Gipsscheren
MICK Bandage and plaster scissors
MICK Tijeras para vendajes y Cizallas para escayolas
MICK Forbici per bendaggi e gessi

Frauenmodell
Female pattern
Modelo femenino
Modello da donna



Gipsschere nach MICK

In Zusammenarbeit mit dem langjährig erfahrenen Gipspfleger Friedrich MICK haben wir eine Gipsschere für den Einsatz mit den heute gängigen Gips- und Kunststoffmaterialien entwickelt. Die besondere Ergonomie der Schere ist geeignet für ein ermüdungsfreies Arbeiten im Dauereinsatz. Durch die Unterteilung in ein Männer- und ein Frauenmodell ist die Gipsschere nach Mick für jeden Handtyp bestens geeignet.

Besondere Merkmale der Gipsschere nach MICK:

- Hervorragende Kraftübertragung durch aktiven Einsatz aller Finger einer Hand
- Spezialvergütete Schnittfläche (Super Cut Schliff)
- Ergonomische Anpassung der Griffform
- Reinigungsfreundliche Hochglanzoberfläche
- Speziell angepasste Varianten für Männer- bzw. Frauenhand ermöglichen einen ermüdungsfreien Einsatz

MICK Cast Scissors

In cooperation with Friedrich MICK, a male nurse with many years of experience in the care of orthopedic casts, we have developed cast scissors for use with plaster and plastic materials common today. Continuous, fatigue-free use is made possible by the special ergonomics of the scissors. Due to the classification into a men's and women's pattern, the MICK Cast Scissors are ideal for any type of hand.

Special characteristics of the MICK Cast Scissors:

- Excellent power transfer by actively using all fingers of one hand
- Specially hardened and tempered cutting surface (Super Cut)
- Shape of the handle ergonomically designed
- Easy-to-clean highly-polished surface
- Specially adapted pattern for men's and women's hands considerably reduce fatigue for medical staff

Tijeras para cortar yeso según MICK

Trabajando en colaboración con el experimentado experto en escayolas Friedrich MICK, hemos desarrollado unas tijeras concebidas para los materiales sintéticos y de escayola que se utilizan hoy en día. La perfecta ergonomía de estas tijeras permite trabajar de forma continua con ellas sin sentir fatiga. Además, como existe un modelo para hombres y uno para mujeres, las tijeras para cortar yeso según Mick se adaptan a la anatomía de cualquier mano.

Características especiales de las tijeras para cortar yeso según MICK:

- Magnífica transferencia de fuerza gracias al uso activo de todos los dedos de una mano.
- Superficie de corte con un tratamiento especial (afilado Supercut)
- Adaptación ergonómica de la forma del mango
- Superficie de alto brillo fáciles de limpiar
- Las variantes especialmente adaptadas a las manos masculinas y femeninas reducen la fatiga durante el uso

Forbici per gessi di MICK

Grazie alla collaborazione di Friedrich MICK, un gessista che vanta una lunga esperienza, abbiamo sviluppato una forbice per gessi adatta ai materiali sintetici ai gessi utilizzati attualmente.

La particolare ergonomia delle forbici rende più semplice l'utilizzo prolungato. Grazie ai due modelli per uomo e donna, le forbici per gesso di Mick si adattano perfettamente a ogni tipo di mano.

Particolari caratteristiche delle cesoie per gesso di MICK:

- Eccellente trasmissione della forza mediante l'impiego di tutte le dita di una mano
- Superficie di taglio ottimizzata (Super Cut Schliff)
- Impugnatura ergonomica
- Superficie lucida per facilitare la pulizia
- Modelli speciali adatti per le mani di uomini e donne consentono un utilizzo semplice

MICK

48-010-17 F 17,5 cm, 6 ³/₄ "

Männermodell
Male pattern
Modelo masculino
Modello da uomo



MICK

48-010-17 M 17,5 cm, 6 ³/₄ "

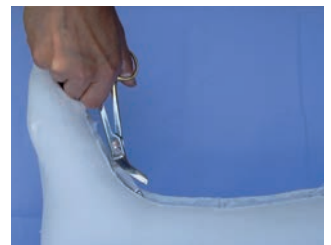

Fuss-Verbandschere nach MICK

Speziell für schwer zugängliche Stellen, z.B. Fußsrücken, Ellenbogen und Handrücken wurde von Friedrich MICK die stark abgerundete Verbandschere für den Gipspsalt entwickelt. Die ergonomisch angepasste Biegung der Fuss-Verbandschere nach MICK in Verbindung mit dem SUPERCUT Schliff, ermöglicht ein problemloses Durchtrennen der Unterpolsterung bis zur letzten Faser.

Besondere Merkmale der Fuss-Verbandschere nach MICK:

- Spezialvergütete Schnittfläche (Super Cut Schliff)
- Reinigungsfreundliche Hochglanzoberfläche
- Die spezielle Form der Fuss-Verbandschere n. MICK ermöglicht ein sicheres durchgleiten zwischen Haut und Unterpolsterung.

MICK Foot Plaster Scissors

This strongly curved plaster scissors was especially developed from Friedrich MICK to reach hard accessible areas as such as dorsum of foot, elbow and back of the hand. The ergonomically curve of this MICK foot-plaster scissors in combination with the SUPERCUT feature allows the easy cut through of the full cushion.

Special characteristics of the MICK Foot Plaster Scissors:

- Specially hardened and tempered cutting surface (Super Cut)
- Easy-to-clean highly-polished surface
- The very special design of the MICK Foot-Plaster Scissors allows a totally safe sliding between skin and cushion

Tijeras para vendajes según MICK

Friedrich MICK ha desarrollado unas tijeras para vendajes fuertemente redondeadas que están concebidas específicamente para cortar escayolas en puntos de difícil acceso, como el dorso del pie, el codo y el dorso de la mano. La flexión ergonómicamente adaptada de la tijera para vendajes según MICK, en combinación con el afilado Supercut, permite cortar hasta la última fibra del relleno interior de la escayola.

Características especiales de las tijeras para vendajes según MICK:

- Superficie de corte con un tratamiento especial (afilado Supercut)
- Superficie de alto brillo fácil de limpiar
- La forma especial de las tijeras para vendajes según MICK permite un deslizamiento seguro entre la piel y el relleno interior.

Forbici di MICK per bendaggi del piede

Sviluppate da Friedrich MICK in modo particolare per punti difficilmente accessibili, per esempio, il dorso del piede, il gomito e il dorso della mano, queste forbici per bendaggi sono molto smussate. La curvatura ergonomica della forcibice di MICK per bendaggi del piede, insieme a al SUPERCUT Schliff, consentono il taglio dei materiali fino all'ultima fibra.

Particolari caratteristiche delle forbici di MICK per bendaggi del piede:

- Superficie di taglio ottimizzata (Super Cut Schliff)
- Superficie lucida per facilitare la pulizia
- La forma speciale della forcibice di MICK per bendaggi del piede consentono lo scivolamento sicuro tra pelle e bendaggi.



MICK

48-010-16 16,0 cm, 6 1/4"

Verbandschere nach MICK

Um das Scherenprogramm für den Gipsraum abzurunden haben wir mit Friedrich MICK eine spezielle Verbandschere entwickelt, die dem Anforderungsprofil der Anwender in Klinik und Praxis gerecht wird. Die langjährige Erfahrung von Friedrich MICK spiegelt sich besonders in der Ergonomie dieses Produkts, im Bereich der Griffe, des Handlings (Länge & Gewicht) und dem angepassten Verletzungsschutz am Ende des unteren Schneideblattes wieder.

Besondere Merkmale der Verbandschere nach MICK:

- Spezialvergütete Schnittfläche (Super Cut Schliff)
- Reinigungsfreundliche Hochglanzoberfläche
- Ergonomische Anpassung der Griffform

MICK Plaster Scissors

To complete the range of scissors for the plaster room, we have developed a special plaster scissors with Friedrich MICK, which fully meets the requirements of the user in hospitals and clinical practice. Friedrich MICK's long term experience is reflected in the ergonomics of this product, mainly at the handles, during usage (length & weight) and the aligned protection tip at the end of the lower blade.

Special characteristics of the MICK Plaster Scissors:

- Specially hardened and tempered cutting surface (Super Cut)
- Easy-to-clean highly-polished surface
- Shape of the handle ergonomically designed

Tijeras para vendajes MICK

Y, para completar la línea de tijeras, hemos desarrollado junto con Friedrich MICK unas tijeras para vendajes especiales que cumplen todos los requisitos del usuario, tanto en la clínica como en la práctica. La larga experiencia de Friedrich MICK se refleja de forma especial en la ergonomía de este producto en el mango o la manipulación (longitud y peso) y en la protección frente a daños adaptada que se incorpora al final de la hoja de corte inferior.

Características especiales de las tijeras para vendajes según MICK:

- Superficie de corte con un tratamiento especial (afilado Supercut)
- Superficie de alto brillo fácil de limpiar
- Adaptación ergonómica de la forma del mango

Forbici di MICK per bendaggi

Per completare la dotazione delle forbici per la sala gessi, abbiamo realizzato insieme a Friedrich MICK speciali forbici per bendaggi, che soddisfano le esigenze dell'operatore in ambito clinico e ambulatoriale. La lunga esperienza di Friedrich MICK si rispecchia in particolare nell'ergonomia di questo prodotto, nel manico, nell'impugnatura (lunghezza e peso) e nel design specificamente pensato per evitare eventuali lesioni che potrebbero verificarsi dopo aver tagliato gli strati inferiori.

Particolari caratteristiche delle forbici per bendaggi di MICK:

- Superficie di taglio ottimizzata (Super Cut Schliff)
- Superficie lucida per facilitare la pulizia
- Impugnatura ergonomica



MICK

48-010-18 18,0 cm, 7"



48-011-16
48-011-19



LISTER

48-011-16 16,0 cm, 6 1/4"
48-011-19 19,0 cm, 7 1/2"



48-012-16



48-012-16 16,0 cm, 6 1/4"



48-013-20
48-013-23

ESMARCH

48-013-20 20,0 cm, 8"
48-013-23 23,0 cm, 9"



BERGMANN

48-015-23 23,0 cm, 9"



LORENZ

48-016-23 23,0 cm, 9"



BRUNS

48-017-23 23,5 cm, 9 1/4"

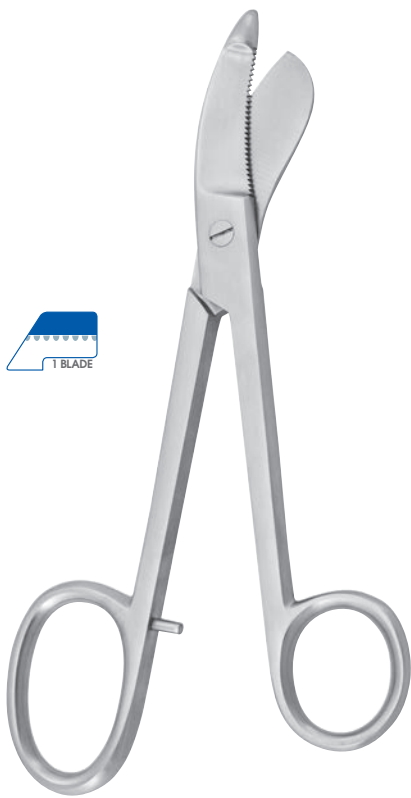

BRUNS

48-017-24 24,0 cm, 9 ¼"



BRUNS

48-019-23 23,0 cm, 9"



48-030-20 20,0 cm, 8"



UNIVERSAL

48-021-15 - 48-029-15 15,0 cm, 6"
48-021-18 - 48-029-18 18,0 cm, 7"



SEUTIN

48-030-23 23,0 cm, 9"



STILLE

48-032-24 24,0 cm, 9 ½"



STILLE

48-033-20	20,0 cm, 8"
48-033-23	23,0 cm, 9"
48-033-26	26,0 cm, 10 ¼"
48-033-37	37,0 cm, 14 ½"



HAGLUND-STILLE

48-039-48 28,0 cm, 11 "



HENNIG

48-040-28 28,0 cm, 11 "



BEESON

48-042-30 30,0 cm, 11 ¾ "



QUATTRO

48-043-23 23,0 cm, 9"



MOD. USA

48-044-23 23,0 cm, 9"



WOLFF

48-045-18 18,0 cm, 7"
48-045-24 24,0 cm, 9 1/2"



ENGEL

48-046-14 14,0 cm, 4 ½"



BERGMANN

48-046-18 18,0 cm, 7"



WIGMORE

48-047-19 19,0 cm, 7 ½"



HOPKINS

48-048-20 20,0 cm, 8"



ESMARCH

48-050-18 18,0 cm, 7"



REINER

48-052-18 18,5 cm, 7 ¼"



MARTIN

48-054-21 21,0 cm, 8 ¼"



- Robuste Konstruktion
- Hohe Belastbarkeit im Dauerbetrieb
- Vibrationsarm
- Eingebauter Überlastungsschutz
- Construcción robusta
- Alta capacidad de carga también en régimen continuo
- Amortiguación de la vibración
- Protección incorporada contra sobrecarga
- Robust construction
- Maximum capacity also in permanent service
- Low vibration
- Built-in overload protection
- Construzione robusta
- Alta capacità di carica a regime continuo
- Vibrazioni attenuate al minimo
- Protezione di sovraccarico incorporata

ELECTRO POWER

48-100-00	230 V 50 Hz
48-100-01	120 V 60 Hz

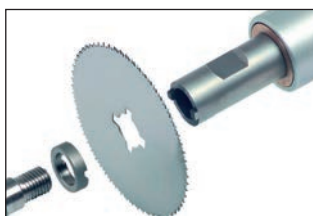

Komplett, bestehend aus:

1 Oszillierende Gipssäge	
1 Sägeblatt, Ø 50 mm	48-110-50
1 Sägeblatt, Ø 65 mm	48-110-65
1 Gabelschlüssel, paar	48-110-01

Complete, consisting of:

1 Oscillating plaster saw	
1 Saw blade, Ø 50 mm	48-110-50
1 Saw blade, Ø 65 mm	48-110-65
1 Wrench, pair	48-110-01

Completo, compuesto de:

1 Sierra eléctrica oscilante yeso	
1 Hoja de sierra, Ø 50 mm	48-110-50
1 Hoja de sierra, Ø 65 mm	48-110-65
1 Llaves de boca, par	48-110-01

Completo, composto da:

1 Segha elettriche oscillante gesso	
1 Segha, Ø 50 mm	48-110-50
1 Segha, Ø 65 mm	48-110-65
1 Chiavi fisse, paio	48-110-01

Technische Daten

Anschlußspannung 230 V~, 50 Hz / 110 V~, 60 Hz
Leistung 500 Watt
Schwingungen 3.500 bis 24.000 Schwingungen / Minute stufenlos regulierbar
Anschlußkabel 5 Meter-Kabel mit Euro-Flachstecker (230 V)
3 Meter-Kabel mit USA-Stecker (110 V)
Gewicht: 1,3 kg (1,5 kg mit Kabel)

Technical data

Supply voltage 230 V~, 50 Hz / 110 V~, 60 Hz
Power 500 Watt
Oscillations 3.500 to 24.000 oscillations / minute steplessly adjustable
Connection cable 5 meter cable with Euro-plug (230 V)
3 meter cable with USA-plug (110 V)
Weight: 1,3 kg (1,5 kg with cable)

Datos técnicos

Tensión de alimentación 230 V~, 50 Hz / 110 V~, 60 Hz
Potencia absorbida 500 Watt
Oscilaciones de 3.500 a 24.000 oscilaciones por minuto regulación progresiva.
Cable de alimentación: Cable de 5 metros con enchufe plano para Europa (230 V) Cable de 3 metros con enchufe para EE.UU. (110 V)
Peso: 1,3 kg (1,5 kg con cable)

Dati tecnici

Tensione di collegamento 230 V~, 50 Hz / 110 V~, 60 Hz
Potenza assorbita 500 Watt
Oscillazioni da 3.500 a 24.000 oscillazioni al minuto, con regolazione continua
Cavo di collegamento: Cavo da 5 metri con spina piatta europea (230 V)
Cavo di 3 metri con spina USA (110 V)
Peso 1,3 kg (1,5 kg con cavo)



- Geringes Gewicht
- Geräuscharm
- Permanentmagnetmotor
- Low weight
- Noise reduced
- Permanent magnet engine
- Peso bajo
- Ruido reducido
- Motor permanente del imán
- Peso ridotto
- Rumore ridotto
- Motore permanente del magnete

BLUE POWER

48-106-00	230 V 50 Hz
48-106-01	110 V 60 Hz



Komplett, bestehend aus:	Complete, consisting of:
1 Oszillierende Gipssäge	1 Oscillating plaster saw
1 Sägeblatt, Ø 50 mm 48-110-50	1 Saw blade, Ø 50 mm 48-110-50
1 Sägeblatt, Ø 65 mm 48-110-65	1 Saw blade, Ø 65 mm 48-110-65
1 Gabelschlüssel, paar 48-110-01	1 Wrench, pair 48-110-01

Completo, compuesto de:	Completo, composto da:
1 Sierra eléctrica oscilante yeso	1 Sega elettriche oscillante gesso
1 Hoja de sierra, Ø 50 mm 48-110-50	1 Sega, Ø 50 mm 48-110-50
1 Hoja de sierra, Ø 65 mm 48-110-65	1 Sega, Ø 65 mm 48-110-65
1 Llaves de boca, par 48-110-01	1 Chiavi fisse, paio 48-110-01

Technische Daten

Anschlußspannung 230/240 V~, 50/60 Hz / 110/115 V~, 60 Hz
 Leistung 210 Watt
 10.000 bis 19.000 Schwingungen / Minute stufenlos regulierbar.
 Anschlußkabel 3 Meter-Kabel mit Euro-Flachstecker (230/240 V)
 3 Meter-Kabel mit USA-Stecker (110/115 V)
 Gewicht: 0,97 kg (1,16 kg mit Kabel)

Technical data

Supply voltage 230/240 V~, 50/60 Hz / 110/115 V~, 60 Hz
 Power 210 Watt
 10.000 to 19.000 oscillations / minute steplessly adjustable
 Connection cable 3 meter cable with Euro-plug (230/240 V)
 3 meter cable with USA-plug (110/115 V)
 Weight: 0,97 kg (1,16 kg with cable)

Datos técnicos

Tensión de alimentación 230/240 V~, 50/60 Hz / 110/115 V~, 60 Hz
 Potencia absorbida 210 Watt
 10.000 a 19.000 oscilaciones por minuto regulación progresiva.
 Cable de alimentación: Cable de 5 metros con enchufe plano para Europa (230/240 V)
 Cable de 3 metros con enchufe para EE.UU. (110/115 V)
 Peso: 0,97 kg (1,16 kg con cable)

Dati tecnici

Tensione di collagamento 230/240 V~, 50/60 Hz / 110/115 V~, 60 Hz
 Potenza assorbita 210 Watt
 10.000 a 19.000 oscillazioni al minuto, con regolazione continua
 Cavo di collegamento: Cavo da 3 metri con spina piatta europea (230/240 V)
 Cavo di 3 metri con spina USA (110/115 V)
 Peso 0,97 kg (1,16 kg con cavo)



komplett mit Säge
complete with saw
completo con sierra
completo con sega

ELECTRO POWER

48-105-00 230 V | 50 Hz

Komplett, bestehend aus:

1 Oszillierende Gipssäge	48-100-00
1 Sägeblatt, Ø 50 mm	48-110-50
1 Sägeblatt, Ø 65 mm	48-110-65
1 Gabelschlüssel, paar	48-110-01
1 Staubsauger inkl. Schlauch und Ständer	
1 Ablageschale für Gipssäge	
1 Saugdüse für die Befestigung des Schlauches an der Gipssäge	
1 Filter und Papiersäcke	

Complete, consisting of:

1 Oscillating plaster saw	48-110-00
1 Saw blade, Ø 50 mm	48-110-50
1 Saw blade, Ø 65 mm	48-110-65
1 Wrench, pair	48-110-01
1 Vacuum cleaner incl. suction tube and support device for tube	
1 Support plate for plaster saw	
1 Suction nozzle to connect the suction tube to the plaster saw	
1 Filters and paper bags	

Completo, compuesto de:

1 Sierra eléctrica oscilante	48-100-00
1 Hoja de sierra, Ø 50 mm	48-110-50
1 Hoja de sierra, Ø 65 mm	48-110-65
1 Llaves de boca, par	48-110-01
1 Aspirador incl. manguera de aspiración y soporte	
1 Bandeja para depositar la sierra de yeso	
1 Tobera aspiradora para la fijación de la manguera de aspiración a la sierra de yeso	
1 Filtros y saco de papel	

Completo, composto da:

1 Segha elettriche oscillante	48-100-00
1 Segha, Ø 50 mm	48-110-50
1 Segha, Ø 65 mm	48-110-65
1 Chiavi fisse, paio	48-110-01
1 Aspiratore incl. tubo di aspirazione e supporto	
1 Appoggio per sega gessi	
1 Ugello per l'applicazione del tubo d' aspirazione alla sega	
1 Filtri e sacchetto di carta	

Technische Daten

Anschlußspannung 230 V~, 50 Hz
Dauerleistung 400 - 750 Watt
Spitzenleistung 900 Watt
Filtrierung HEPA Filter 99,97 % (0,3 micron)
Tankinhalt 20 l
Luftstrom 52 l/s
Geräuschpegel 65 - 80 db (+-5)

Technical data

Supply voltage 230 V~, 50 Hz
Permanent power 400 - 750 Watt
Top power 900 Watt
Filtration HEPA Filter 99,97 % (0,3 micron)
Tank capacity 20 l
Air volume 52 l/s
Noise level 65 - 80 db (+-5)

Datos técnicos

Tensión de alimentación 230 V~, 50 Hz
Redimiento continuo 400 - 750 watio
Redimiento máximo 900 watio
Filtración HEPA Filter 99,97 % (0,3 micron)
Capacidad del tanque 20 l
Corriente atmosférica 52 l/s
Nivel de ruido 65 - 80 db (+-5)

Dati tecnici

Tensione di collagamento 230 V~, 50 Hz
Alimentazione permanente 400 - 750 Watt
Alimentazione superiore 900 Watt
Filtrazione HEPA Filter 99,97 % (0,3 micron)
Capacità del cassone 20 l
Volume di aria 52 l/s
Livello del rumore 65 - 80 db (+-5)

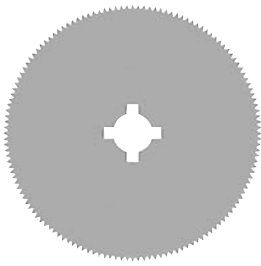

48-110-45 Ø 45,0 mm

48-110-50 Ø 50,0 mm

48-110-65 Ø 65,0 mm

Sägeblatt für Naturgipsverbände
 Saw blade for normal plaster
 Hoja de sierra para vendaje de yeso
 Sega per bendaggi in gesso naturale

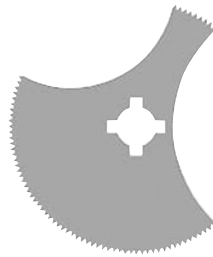

48-130-65 Ø 65,0 mm

Sägeblatt Autopsie für Naturgipsverbände
 Autopsy saw blade for normal plaster
 Hoja de sierra de autopsia para vendaje de yeso
 Sega autopsia per bendaggi in gesso naturale

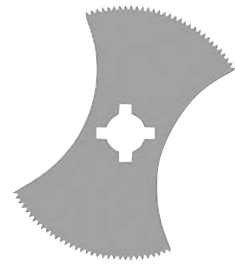

48-150-65 Ø 65,0 mm

Sägeblatt Segment für Naturgipsverbände
 Segmented saw blade for normal plaster
 Hoja de sierra de segmentos para vendaje de yeso
 Sega segmento per bendaggi in gesso naturale

48-120-45 Ø 45,0 mm

48-120-50 Ø 50,0 mm

48-120-65 Ø 65,0 mm

Sägeblatt für synthetische Hartverbände
 Saw blade for synthetic casts
 Hoja de sierra de profundidad para vendajes sintéticos rígidos
 Sega per bendaggi duri sintetici

48-140-65 Ø 65,0 mm

Sägeblatt Autopsie für synthetische Hartverbände
 Autopsy saw blade for synthetic casts
 Hoja de sierra de autopsia para vendajes sintéticos rígidos
 Sega autopsia per bendaggi duri sintetici

48-160-65 Ø 65,0 mm

Sägeblatt Segment für synthetische Hartverbände
 Segmented saw blade for synthetic casts
 Hoja de sierra de segmentos para vendajes sintéticos rígidos
 Sega segmento per bendaggi duri sintetici

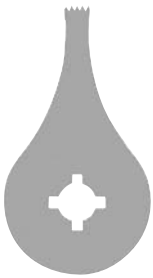

48-170-08 8,0 mm

48-170-20 20,0 mm

Tiefensägeblatt für Naturgipsverbände
 Deep saw blade for normal plaster
 Hoja de sierra de profundidad para vendaje de yeso
 Sega a taglio di profondità per bendaggi in gesso naturale

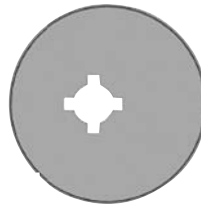

48-190-99 Ø 65,0 mm

Exzentrische Begrenzungsscheibe für Tiefenbegrenzung
 Excentric disc to limit depth of cut
 Disco de tope excéntrico para tope de profundidad
 Disco di limitazione eccentrico per limitazione della profondità



48-110-01

Gabelschlüssel für Sägeblattwechsel, Paar
 Wrenches for exchange of saw blades, pair
 Llaves de boca para cambiar la hoja de sierra, par
 Chiavi per cambiare la lama per sega, paio

48-180-08 8,0 mm

48-180-20 20,0 mm

Tiefensägeblatt für synthetische Hartverbände
 Deep saw blade for synthetic casts
 Hoja de sierra de profundidad para vendaje sintéticos rígidos
 Sega a taglio di profondità per bendaggi duri sintetici



48-110-02

Transportkoffer, blau, inklusive Formeinlage für BLUE oder ELEKTRO POWER
 Transport case, blue, including inlay for BLUE or ELECTRO POWER
 Transporte valija, azul, inclusive pieza postiza per BLUE o ELECTRO POWER
 Cargo valigetta, blu, incluso inserto per BLUE o ELECTRO POWER



49



Arthroskopie Instrumente

Arthroscopy Instruments

Instrumentos para Artroscopia

Strumenti per Artroscopia

Fordern Sie unser Spezialprospekt an
Please ask for our special catalogue
No duden pedirnos más catálogos especiales
Chiedete i nostri cataloghi speciali



50



Stationsinstrumente

Ward Instruments

Instrumentos para enfermería

Strumenti per medicazione



50-005-08 8,5 cm, 3 1/3"



50-006-09 9,0 cm, 3 1/2"
50-006-10 10,0 cm, 4"



50-007-09 9,0 cm, 3 1/2"
50-007-10 10,0 cm, 4"



50-008-09 9,0 cm, 3 1/2"
50-008-10 10,5 cm, 4 1/4"



50-009-09 9,0 cm, 3 1/2"
50-009-10 10,5 cm, 4 1/4"



50-014-09 9,5 cm, 3 3/4"



50-015-09 9,5 cm, 3 3/4"



50-017-13 13,0 cm, 5 1/8"

SYSTRUNK



50-018-02



50-021-11



50-022-12 12,0 cm, 4 3/4"

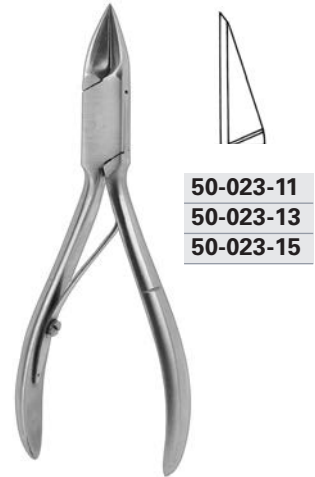

50-023-11
 50-023-13
 50-023-15

50-018-02 10,5 cm, 4 1/4"

50-021-11 11,0 cm, 4 3/8"

50-023-11 11,5 cm, 4 1/2"
 50-023-13 13,0 cm, 5 1/8"
 50-023-15 15,0 cm, 6"



TURNBULL

50-024-11 11,5 cm, 4 1/2"
 50-024-13 13,0 cm, 5 1/8"



50-024-14 14,0 cm, 5 1/2"



50-025-14 14,0 cm, 5 1/2"



50-026-14 14,0 cm, 5 1/2"

Nagelzangen, Nagelfeilen
 Nail nippers, Nail files
 Pinzas para cortar uñas, Limas para uñas
 Tronchesini per unghie, Lime per unghie



50-027-14 14,0 cm, 5 1/2"
50-027-16 16,0 cm, 6 1/4"



50-028-15 15,0 cm, 6"



ANVIL
50-029-13 13,5 cm, 5 1/4"

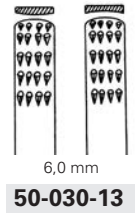

RADOLF
50-030-13 13,0 cm, 5 1/8"



50-031-11 11,0 cm, 4 3/8"



50-032-10 10,0 cm, 4"
50-032-12 12,0 cm, 4 3/4"



50-032-16 16,0 cm, 6 1/4"





Schwesterngarnitur
Set for nurses
Surtido para enfermeras
Nexessario per infermiera

50-040-00 SET



0,99 mm

50-034-01

Bohrer, allein
Drill, only
Brocas, sueltas
Trapano, solo

1,40 mm

50-034-02

Bohrer, allein
Drill, only
Brocas, sueltas
Trapano, solo

2,28 mm

50-034-03

Bohrer, allein
Drill, only
Brocas, sueltas
Trapano, solo

Nagelbohrer, komplett
Finger nail drill, complete
Taladro para uñas, completo
Ghiaccia unghie, completo

50-034-00 SET

Schwesterngarnitur
Set for nurses
Surtido para enfermeras
Nexessario per infermiera



50-040-01 SET

Hornhauthobel, nicht sterilisierbar
Callosity Plane, not autoclavable
Cuchillas corta-callos, no esterilizables
Lima per cute ispessita, non sterilizzabile



CREDO

50-050-00 14,0 cm, 5 1/2 "



Verpackungseinheit: 10 St.
Packing unit: 10 pieces
Unidad: 10 piezas
Confezione: 10 pezzi

Rasierklingen, brechbar
Razor blades, breakable
Hojas de afeitár, rompibles
Lamette di rasoio, per rompere,



50-050-01

STEEL
STAINLESS



50-054-15



RALK

50-054-15 15,0 cm, 6"

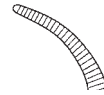

50-055-11



PEET

50-055-11 11,0 cm, 4 3/8"

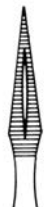

50-056-13



50-057-13



STIEGLITZ

50-056-13 - 50-057-13 13,5 cm, 5 1/4"

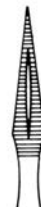

50-058-13



50-059-13



STIEGLITZ

50-058-13 - 50-059-13 13,5 cm, 5 1/4"



DAVIS

50-060-16	16,0 cm, 6 ¼"
50-060-20	20,0 cm, 8"
50-060-24	24,0 cm, 9 ½"



CHEATTLE

50-061-28	28,0 cm, 11"
------------------	--------------

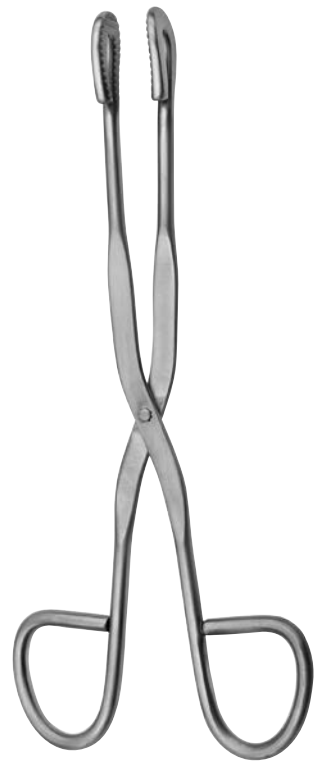

UNIVERSAL

50-062-20	20,0 cm, 8"
50-062-30	30,0 cm, 11 ¾"



UNIVERSAL

50-063-20	20,0 cm, 8"
50-063-30	30,0 cm, 11 ¾"



UNIVERSAL

50-064-20	20,0 cm, 8"
50-064-30	30,0 cm, 11 ¾"

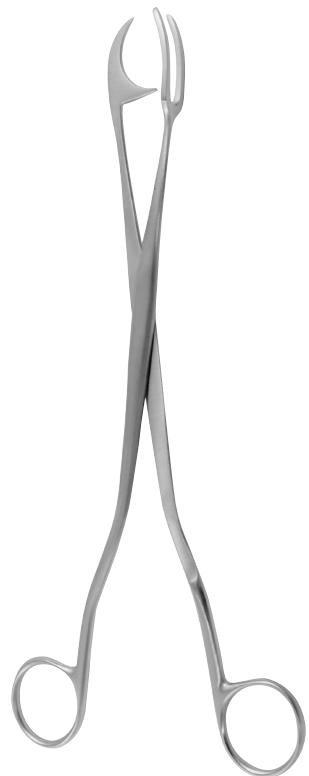

ROGGE

50-066-23	23,0 cm, 9"
------------------	-------------



51



Behälter, Gefäße

Stainless Steel Holloware

Recipientes

Recipienti

Nierenschalen
Kidney Dishes
Riñoneras
Bacinelle reniformi



51-100-17	170 x 100 x 35 mm
51-100-25	250 x 140 x 40 mm
51-100-27	270 x 150 x 45 mm

Runde Schalen
Round Bowls
Cubetas redondas
Scodelle rotonde



51-101-14	140 x 55 mm	0,50 l
51-101-16	150 x 75 mm	0,75 l
51-101-17	160 x 75 mm	1,00 l
51-101-22	220 x 75 mm	2,00 l
51-101-23	225 x 90 mm	2,50 l
51-101-24	240 x 95 mm	3,00 l
51-101-25	255 x 115 mm	3,50 l
51-101-27	260 x 120 mm	4,50 l
51-101-29	290 x 125 mm	6,00 l
51-101-31	300 x 115 mm	6,00 l
51-101-34	320 x 140 mm	8,50 l
51-101-38	380 x 130 mm	11,00 l
51-101-41	400 x 155 mm	14,00 l

Runde Schalen
Round Bowls
Cubetas redondas
Scodelle rotonde



51-103-04	Ø 40 x 19 mm	0,05 l
51-103-06	Ø 61 x 30 mm	0,07 l
51-103-08	Ø 80 x 40 mm	0,14 l
51-103-11	Ø 116 x 50 mm	0,35 l
51-103-12	Ø 128 x 55 mm	0,45 l
51-103-14	Ø 147 x 65 mm	0,70 l
51-103-16	Ø 210 x 90 mm	2,50 l

Runde Schalen
Round Bowls
Cubetas redondas
Scodelle rotonde



51-105-11	Ø 116 x 35 mm	0,30 l
51-105-12	Ø 128 x 38 mm	0,40 l
51-105-14	Ø 147 x 40 mm	0,50 l
51-105-15	Ø 157 x 45 mm	0,75 l
51-105-18	Ø 187 x 45 mm	1,00 l

Lösungsschalen
Solution bowls
Cubetas para soluciones
Arcelle



51-106-04	Ø 50 x 45 mm	0,05 l
51-106-05	Ø 60 x 52 mm	0,07 l

Lösungsschalen
Solution bowls
Cubetas para soluciones
Arcelle



51-106-10	Ø 75 x 103 mm	0,25 l
------------------	---------------	--------

Standgefäße
Jars
Recipientes
Recipienti



51-107-01	Ø 30 x 90 mm
51-107-02	Ø 50 x 100 mm
51-107-03	Ø 50 x 130 mm
51-107-04	Ø 50 x 175 mm
51-107-05	Ø 75 x 100 mm
51-107-06	Ø 75 x 130 mm
51-107-07	Ø 75 x 175 mm
51-107-08	Ø 85 x 175 mm
51-107-09	Ø 95 x 200 mm

Medizinlöffel, innen graduert
Medicine spoon, graduated inside
Cuchara medicinal, graduado interiormente
Cucchiaio per medicine, graduato all'interno



51-109-00 110 x 30 mm 12,5 ml

Medizinbecher, innen graduert
Medicine cup, graduated inside
Vaso medicinal, graduado interiormente
Bicchieri per medicinale, graduato all'interno



51-109-01 50 x 25 mm 25,0 ml

Medizinbecher, innen graduert
Medicine cup, graduated inside
Vaso medicinal, graduado interiormente
Bicchieri per medicinale, graduato all'interno



51-109-02 Ø 53 x 45 mm 50,0 ml

Messbecher, innen graduert
Measuring cup, graduated inside
Vaso-medidas, graduado interiormente
Bicchieri graduati, graduato all'interno



51-109-03	0,25 l
51-109-04	0,50 l
51-109-05	1,00 l
51-109-06	2,00 l

Messbecher, innen graduert
Measuring cup, graduated inside
Vaso-medidas, graduado interiormente
Bicchieri graduati, graduato all'interno



51-110-00 100,0 ml

Dosen, mit Knopfdeckel
Dish, lid with knob
Recipientes, tapa con botón
Recipienti con coperchio a bottone



51-111-01	Ø 75 x 60 mm
51-111-02	Ø 75 x 75 mm
51-111-03	Ø 100 x 60 mm
51-111-04	Ø 100 x 100 mm
51-111-05	Ø 125 x 80 mm
51-111-06	Ø 125 x 125 mm
51-111-07	Ø 150 x 150 mm

Sputumbecher
Sputum cup
Escupidera
Sputacchiera



51-112-09 Ø 75 x 75 mm 0,30 l

Mundbecher
Metal cup
Vaso metalico
Bicchiere metallico



51-112-90 Ø 90 x 90 mm

Runde Schale
Round bowl
Cubetas redondas
Scodelle rotonde



51-113-15 Ø 110 x 28 mm 0,15 l

Petrishale
Petri dish
Cápsulas de Petri
Scodella di Petri



51-116-00 SET

Schale, allein
Dish, only
Cápsulas, suelta
Scodella, solo

51-116-01 Ø 96 x 20 mm

Deckel, allein
Lid, only
Tapa, suelta
Coperchio, solo

51-116-02 Ø 100 x 20 mm

Irrigatoren
Irrigators
Irrigadores
Irrigatori



51-119-01	Ø 100 x 160 mm	1,00 l
51-119-02	Ø 130 x 170 mm	1,50 l
51-119-03	Ø 130 x 190 mm	2,00 l

Stechbecken
Bed Pans
Stilletas
Padelle



51-120-00	Ø 310 x 80 mm
51-120-01	Ø 230 x 70 mm

Instrumentenschalen
Instrument trays
Bandejas para instrumentos
Bacinelle per strumenti



51-120-23	230 x 155 x 30 mm
51-120-30	300 x 175 x 30 mm
51-120-31	300 x 175 x 40 mm
51-120-35	350 x 240 x 40 mm
51-120-40	400 x 300 x 50 mm

Instrumentenschalen
Instrument trays
Bandejas para instrumentos
Bacinelle per strumenti



51-131-23	235 x 190 x 40 mm
------------------	-------------------

Urinal, weiblich
Urinal, female
Orinal, mujer
Urinale, donna



51-121-01 220 x 140 mm

Urinal, männlich
Urinal, male
Orinal, hombre
Urinale, uomo



51-121-02 215 x 120 mm

Instrumentenschalen
Instrument trays
Bandejas para instrumentos
Bacinelle per strumenti



51-130-01 210 x 160 x 10 mm
51-130-02 240 x 180 x 10 mm
51-130-03 310 x 150 x 10 mm
51-130-04 310 x 210 x 10 mm
51-130-05 350 x 240 x 10 mm
51-130-06 400 x 270 x 20 mm
51-130-07 420 x 280 x 10 mm

Instrumentenkästen
Instrument boxes
Cajas para instrumentos
Scatole per strumenti



51-140-01 100 x 60 x 40 mm
51-140-02 120 x 80 x 40 mm
51-140-03 160 x 100 x 30 mm
51-140-04 180 x 120 x 50 mm
51-140-05 200 x 100 x 50 mm
51-140-06 220 x 150 x 50 mm
51-140-07 260 x 150 x 50 mm
51-140-08 300 x 200 x 50 mm
51-140-09 400 x 200 x 80 mm
51-140-11 500 x 270 x 70 mm

Instrumentenkästen
Instrument boxes
Cajas para instrumentos
Scatole per strumenti



51-142-01	170 x 90 x 35 mm
51-142-02	200 x 100 x 50 mm
51-142-03	220 x 150 x 50 mm
51-142-04	260 x 150 x 50 mm
51-142-05	310 x 210 x 50 mm

Instrumentenkästen
Instrument boxes
Cajas para instrumentos
Scatole per strumenti



51-143-18	180 x 80 x 40 mm
51-143-20	200 x 100 x 60 mm
51-143-22	220 x 120 x 60 mm
51-143-25	250 x 120 x 60 mm
51-143-30	300 x 125 x 60 mm
51-143-32	320 x 150 x 60 mm
51-143-50	500 x 200 x 120 mm

Wattespender, mit Deckel
Cotton dispenser, with lid
Dispensadores de algodón, con tapa
Distributori di cotone, con coperchio



51-145-01 Ø 50 x 75 mm

Wattespender, ohne Deckel
Cotton dispenser, without lid
Dispensadores de algodón, sin tapa
Distributori di cotone, senza coperchio



51-145-02 Ø 50 x 75 mm

Wattespender
Cotton dispenser
Dispensadores de algodón
Distributori di cotone



51-146-01 Ø 50 x 75 mm

Einsatz für 51-146-01
Insert for 51-146-01
Injerto para 51-146-01
Inserito per 51-146-01



51-146-02 Ø 45 x 55 mm



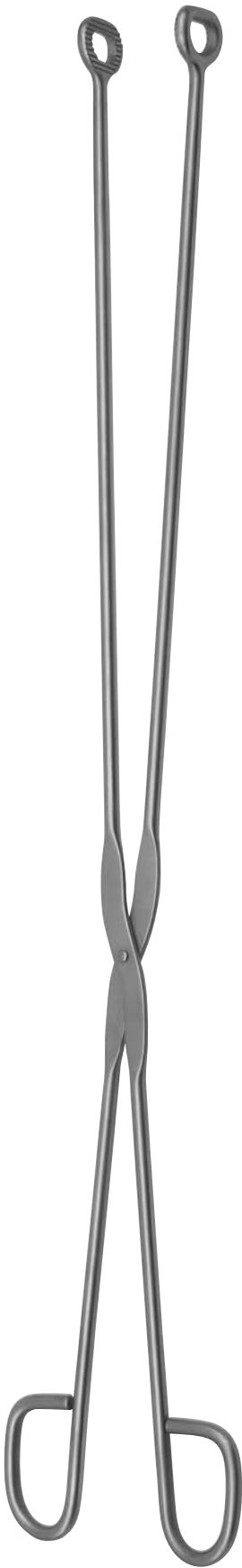

MARTIN

51-470-58 58,0 cm, 22 3/4"



SAUERBRUCH

51-474-55 55,0 cm, 21 1/2"



55



Container Systeme

Container Systems

Sistema de Contenedores

Sistema di Contenitori

Fordern Sie unser Spezialprospekt an
Please ask for our special catalogue
No duden pedirnos más catálogos especiales
Chiedete i nostri cataloghi speciali



Sterilisation

Sterilization

Esterilización

Sterilizzazione

komplett mit perforierter Innendose
complete with perforated inner box
completo con caja interior perforada
completo con scatola interna perforada



56-100-00 Ø 65 x 15 mm

Innendose, allein
Inner box, only
Caja interior, suelta
Scatola interna, solo



56-100-65 Ø 62 x 13 mm



56-102-50 50 x 25 x 4,5 mm

56-102-65 65 x 42 x 8,0 mm

56-102-75 75 x 25 x 4,5 mm



56-110-02 150 x 95 x 13 mm



56-112-01 150 x 95 x 13 mm



56-112-02 150 x 95 x 13 mm



SAUERBRUCH

56-120-00 210 x 125 x 17 mm



SAUERBRUCH

56-120-01 210 x 125 x 17 mm

Nadel-Sterilisationsgestell
Suture needle sterilizing rack
Soporte para esterilizar las agujas de suture
Telaio per sterilizzare aghi per sutura



56-130-00 13,0 cm, 5 1/8 "



SCHIMMELBUSCH

56-152-08 - 56-179-59

56-152-08 Ø 125 x 80 mm
56-152-10 Ø 125 x 100 mm
56-152-12 Ø 125 x 125 mm

56-155-08 Ø 150 x 80 mm
56-155-10 Ø 150 x 100 mm
56-155-13 Ø 150 x 130 mm
56-155-15 Ø 150 x 150 mm
56-155-19 Ø 150 x 190 mm

56-159-14 Ø 190 x 145 mm
56-159-16 Ø 190 x 165 mm
56-159-19 Ø 190 x 190 mm
56-159-24 Ø 190 x 240 mm

56-164-14 Ø 240 x 145 mm
56-164-16 Ø 240 x 165 mm
56-164-19 Ø 240 x 190 mm
56-164-24 Ø 240 x 240 mm
56-164-29 Ø 240 x 290 mm
56-164-34 Ø 240 x 340 mm
56-164-39 Ø 240 x 390 mm

56-169-14 Ø 290 x 145 mm
56-169-16 Ø 290 x 165 mm
56-169-19 Ø 290 x 190 mm
56-169-24 Ø 290 x 240 mm
56-169-29 Ø 290 x 290 mm
56-169-34 Ø 290 x 340 mm
56-169-39 Ø 290 x 390 mm

56-174-14 Ø 340 x 145 mm
56-174-16 Ø 340 x 165 mm
56-174-19 Ø 340 x 190 mm
56-174-24 Ø 340 x 240 mm
56-174-29 Ø 340 x 290 mm
56-174-34 Ø 340 x 340 mm
56-174-39 Ø 340 x 390 mm

56-179-14 Ø 390 x 145 mm
56-179-16 Ø 390 x 165 mm
56-179-19 Ø 390 x 190 mm
56-179-24 Ø 390 x 240 mm
56-179-29 Ø 390 x 290 mm
56-179-34 Ø 390 x 340 mm
56-179-39 Ø 390 x 390 mm
56-179-49 Ø 390 x 490 mm
56-179-59 Ø 390 x 590 mm

56-210-00

Textilfilter (Paar)
Textile filters (pair)
Filtros de tejido (par)
Filtri di tessuti (paio)



KONRICH

56-182-08 - 56-209-59

56-182-08 Ø 125 x 80 mm
56-182-10 Ø 125 x 100 mm
56-182-12 Ø 125 x 125 mm

56-185-08 Ø 150 x 80 mm
56-185-10 Ø 150 x 100 mm
56-185-13 Ø 150 x 130 mm
56-185-15 Ø 150 x 150 mm
56-185-19 Ø 150 x 190 mm

56-189-14 Ø 190 x 145 mm
56-189-16 Ø 190 x 165 mm
56-189-19 Ø 190 x 190 mm
56-189-24 Ø 190 x 240 mm

56-194-14 Ø 240 x 145 mm
56-194-16 Ø 240 x 165 mm
56-194-19 Ø 240 x 190 mm
56-194-24 Ø 240 x 240 mm
56-194-29 Ø 240 x 290 mm
56-194-34 Ø 240 x 340 mm
56-194-39 Ø 240 x 390 mm

56-199-14 Ø 290 x 145 mm
56-199-16 Ø 290 x 165 mm
56-199-19 Ø 290 x 190 mm
56-199-24 Ø 290 x 240 mm
56-199-29 Ø 290 x 290 mm
56-199-34 Ø 290 x 340 mm
56-199-39 Ø 290 x 390 mm

56-204-14 Ø 340 x 145 mm
56-204-16 Ø 340 x 165 mm
56-204-19 Ø 340 x 190 mm
56-204-24 Ø 340 x 240 mm
56-204-29 Ø 340 x 290 mm
56-204-34 Ø 340 x 340 mm
56-204-39 Ø 340 x 390 mm

56-209-14 Ø 390 x 145 mm
56-209-16 Ø 390 x 165 mm
56-209-19 Ø 390 x 190 mm
56-209-24 Ø 390 x 240 mm
56-209-29 Ø 390 x 290 mm
56-209-34 Ø 390 x 340 mm
56-209-39 Ø 390 x 390 mm
56-209-49 Ø 390 x 490 mm
56-209-59 Ø 390 x 590 mm

56-304-01	230 x 130 mm
56-304-02	260 x 150 mm
56-304-03	275 x 325 mm
56-304-04	300 x 200 mm
56-304-05	325 x 275 mm
56-304-06	475 x 175 mm

Ersatz-Textilfilter (10 Stück)
 Spare textile filters (10 pcs.)
 Filtros de tejido de recambio (10 p.)
 Filtri di tessuto di ricambio (10 pezzi)



Deckel gelocht | Boden gelocht
 Lid perforated | Bottom perforated
 Tapa perforado | Fondo perforado
 Coperchio perforato | Fondo perforato

56-300-01 - 56-302-06

56-300-01	230 x 130 x 50 mm
56-300-02	260 x 150 x 50 mm
56-300-03	275 x 325 x 50 mm
56-300-04	300 x 200 x 50 mm
56-300-05	325 x 275 x 50 mm
56-300-06	420 x 175 x 50 mm

56-302-01	230 x 130 x 75 mm
56-302-02	260 x 150 x 75 mm
56-302-04	300 x 200 x 75 mm
56-302-05	325 x 275 x 75 mm
56-302-06	420 x 175 x 75 mm



56-220-25	25,0 cm, 9 3/4"
56-220-32	32,0 cm, 12 1/2"



56-306-20	200 x 100 x 25 mm
56-306-23	230 x 130 x 25 mm

Sterilisier- und Lagerungsgestell, für 8 Mikro-Rundgriff-Instrumente bis 17 cm Länge.
 Rack for sterilisation and storage, for 8 micro surgery instruments up to 17 cm long with round handles.
 Bastidor para esterilizar y conservar, para 8 micro instrumentos con mangos redondos hasta 17 cm de largo.
 Supporto per sterilizzazione e conservazione, per 8 microstrumenti con manico rotondo fino a 17 cm di lunghezza.

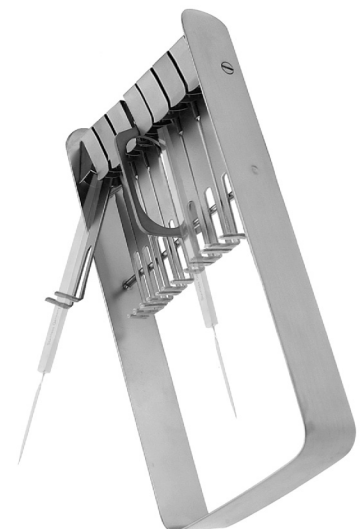

56-322-08	190 x 96 x 30 mm
------------------	------------------



56-900-00 SET

komplett, mit 9 Aufsätzen 56-900-01 – 56-900-09, 1 m Druckschlauch
complete, with 9 tips 56-900-01 – 56-900-09, 1 m pressure tube
completo, con 9 toberas 56-900-01 – 56-900-09, 1 m tubo de presión
completa, con 9 raccordi 56-900-01 – 56-900-09. 1 m tubo ad alta pressione

56-900-20

Wasserstrahl-Reinigungspistole, allein
Water jet pistol, only
Pistola-lavatoria de chorro de agua, suelta
Pistola lavatrice a getto d'acqua, solo

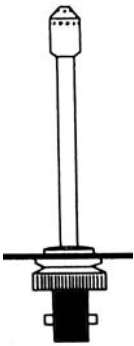

56-900-01

für Flaschen
for bottles
para botellas
per bottiglie



56-900-02

für Record Spritzen
for Record syringes
para jeringas Record
per siringhe Record



56-900-03

für Katheter
for catheters
para catéteres
per cateteri



56-900-04

für Drainageschläuche
for drainage tubes
para tubos de drenaje
per tubi di drenaggio



56-900-05

für Hohlgefäße
for receptacles
para recipientes
per recipienti



56-900-06

für Record Kanülen
for needles with Record-cone
para agujas con cono Record
per aghi con cono Record



56-900-07

für Luer Kanülen
for needles with Luer-cone
para agujas con cono Luer
per aghi con cono Luer



56-900-08

für Pipetten
for pipettes
para pipetas
per pipette

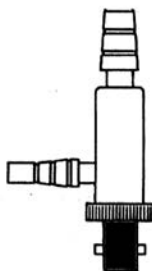

56-900-09

für feine Pipetten
for fine pipettes
para pipetas finas
per pipette fini



56-900-10

für Reinigungsaufsatz
for cleaning tip
para tobera de limpieza
per lavaggio

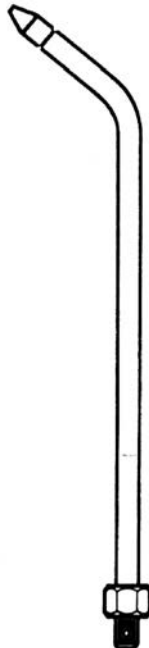

56-900-11

für Reinigungsaufsatz
for cleaning tip
para tobera de limpieza
per lavaggio



56-900-12

Überwurfmutter 1/2 " Coupling 1/2 "
Tuerca-hembra 1/2 " Dado premistoppa 1/2 "



56-900-13

Überwurfmutter 3/4 " Coupling 3/4 "
Tuerca-hembra 3/4 " Dado premistoppa 3/4 "

Handwaschbürste, sterilisierbar
Nailbrush, autoclavable
Cepillo de uñas, sterilizable
Spazzola per unghie, sterilizzabile

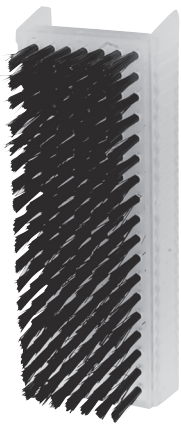

56-911-01



Reinigungsbürste
Cleaning brush
Cepillo de limpieza
Spazzole per pulire

56-912-95 210 x 95 mm



56-915-00 500 ml

Instrumenten Pflegemittel
Instrument care lubricant
Detergente para instrumentos
Detergente per strumenti



56-920-00 1 x 5 l

56-920-01 4 x 5 l



60



Motorensysteme

Motor Systems

Sistema de motor

Sistema di motore

Fordern Sie unser Spezialprospekt an
Please ask for our special catalogue
No duden pedirnos más catálogos especiales
Chiedete i nostri cataloghi speciali



70



Hochfrequenz Chirurgie
High Frequency Surgery

Fordern Sie unser Spezialprospekt an
Please ask for our special catalogue
No duden pedirnos más catálogos especiales
Chiedete i nostri cataloghi speciali



72



Endoskope

Endoscopes

Endoscopios

Endoscopi

Fordern Sie unser Spezialprospekt an
Please ask for our special catalogue
No duden pedirnos más catálogos especiales
Chiedete i nostri cataloghi speciali



Inhaltsverzeichnis

Index of contents

Índice alfabético

Indice alfabetico

A			
Abfallzangen	1218	Atriumhaken	816
ABRAHAM Tonsillenfasszangen	621	AUFRICHT Nasenhaken	687
ABRAHAM Tonsillennmesser	57	AUFRICHT Nasenraspeln	1085, 1090
Absaugküretten	914	AUFRICHT Scheren für die plastische Chirurgie	115
Abszessmesser	57	Autopsie-Besteck	1021
Abziehstein	58	AUVARD Scheidenspekulas	895
ADLERDYCE Elevatorien	1055	AYRE Konisationsmesser	56
ADLERKREUTZ Gefäß- und Tumorpinzetten	214	B	
ADSON Saugrohre	78	BABCOCK Darm- und Gewebefäßzangen	362, 363
ADSON Anatomische Pinzetten	198, 199	BABINSKY Perkussionshammer	17
ADSON Anatomische TC Pinzetten	232	BABY-ADSON Präparier- und Ligaturklemmen	269
ADSON Arterienklemmen	245, 256	BABY-ALLIS Darm- und Gewebefäßzangen	363
ADSON Bohrführungsinstrumente	1012	BABY-COLLIN Bauchdeckenhalter	466
ADSON Chirurgische Pinzetten	209, 210	BABY-CRILE Arterienklemmen	248, 257
ADSON Chirurgische TC Pinzetten	234	BABY-CRILE-WOOD TC Nadelhalter	523
ADSON Durahaken	554, 555	BABY-KOCHER Darmklemmen	844
ADSON Hohlmeißelzangen	1131	BABY-MIKULICZ Peritoneumklemmen	277
ADSON Nadelhalter	489	BABY-MIXTER Präparier- und Ligaturklemmen	270
ADSON Raspatorien	1059	BABY-MOSQUITO Arterienklemmen	251
ADSON Reibahlen	1012	BABY-OVERHOLT Präparier- und Ligaturklemmen	270
ADSON Wundspreizer, selbsthaltend	453, 455, 458-461	BABY-ROUX Wundhaken	416
ADSON-BIEMER-MICRO Chirurgische Pinzetten	211	BABY-SATINSKY Vena-Cava-Klemmen	347
ADSON-BROWN Chirurgische Pinzetten	217	BABY-TISCHLER Uterus-Biopsiezangen	921
ADSON-BROWN Chirurgische TC Pinzetten	235	BABY-YANKAUER Saugrohre	81
ADSON-DE BAKEY Atraumatische Pinzetten	218	BACKHAUS Tuchklemmen	367
ADSON-GRAEFE Chirurgische Pinzetten	217	BACKHAUS-KOCHER Tuchklemmen	367
ADSON-MICRO Anatomische Pinzetten	199	BACON Hohlmeißelzangen	1129
ADSON-MICRO Anatomische TC Pinzetten	232	BAGDLEY Laminektomie-Wundsperrerr	559
ADSON-MICRO Chirurgische Pinzetten	210, 211	BAILEY Laminektomie-Zangen	1007
ADSON-MICRO Chirurgische TC Pinzetten	234	BAILEY-GIBBON Rippenkontraktoren	800
ADSON-MINI Chirurgische Pinzetten	210	BAINBRIDGE Arterienklemmen	246
AGNEW Parazentesenadel	736	BAINBRIDGE Atraumatische Gefäßklemmen	314
ALAN-PARKS Analspreizer	865	BAKES Gallenkanaldilatatoren	872
ALDINGER Knochenheber	1081	BALFOUR Bauchdeckenhalter	470
ALEXANDER Flachmeißel	1030	BALFOUR USA Bauchdeckenhalter	471
ALEXANDER Hohlmeißel	1030	BALFOUR Wundhaken	485
ALEXANDER Raspatorien	1065	BALFOUR-BABY Bauchdeckenhalter	469
ALEXANDER Uterus-Biopsiezangen	920	BALL & SOCKET Tuchklemmen	368
Algesimeter (Nervrädchen)	20	BALLENGER Schwingmesser	679
Algesimeter mit Nadel und Pinsel	20	BALLENGER Septum-Hohlmeißel	679
ALLEN Darmklemmen	844	BALLENGER Tonsillenfasszangen	621
ALLIS Darm- und Gewebefäßzangen	363, 364	BALLENGER-HAJEK Septum-elevatorien	676
ALLIS-ADAIR Darm- und Gewebefäßzangen	365	BARANY Lärmtrommel	716
ALLISON Lungenspatel	800	BARBARA Mikro-Nadel	748, 749
ALM Wundspreizer, selbsthaltend	446	BARNES Saugrohre	88
ALY Algesimeter	20	BARNHILL Ringmesser	629
Aminoskope	864	BARON Saugrohre	88
Amniotom	903	BARR Analspreizer	861
Amputations- und Resektionssägen	1009, 1010	BARRAQUER Cilienpinzetten	223
Amputationsmesser	52	BARRAQUER Mikro-Scheren	140
Amputationsretraktoren	1008	BARRON Hämorrhoidal-Ligatoren	867
Analsonden	866	BARSKY Wundhaken	442
Analspreizer	861, 864-866	BARTH Ohrküretten	730
Anastomoseklemmen	845	BARTH Scharfe Löffel	1092
Anatomische Pinzetten	194-204	Batterie-ladegerät	42
Anatomische Skalpelle	51	Bauch- und Darmspatel	421
ANDERSON-ADSON Wundspreizer, selbsthaltend	453	Bauchdeckenhalter	465-477
ANESTOPHONE Stethoskop	19	Bauchdeckenscheren	97, 98
ANKENEY Rippenspererr	774, 783	BAUMGARTNER Drahtzangen	1159
Anlegezange für Bulldogklemmen	293, 296	BAYHA Skalpellgriffe	44
Antrumhäkchen	747	BAYONET-KERRISON Laminektomie-Stanzen	968-975
Antrumstanzen	693-695	BEACHAM Amniotom	903
Anuskope	862, 863	BEALE Häkchen	748
ANVIL Nagelzangen	1206	BEALES Sehnenmesser	745
Aorta-Dilatatoren	810	BECK Laminektomie-Zangen	994
Aortahaken	816, 817	Beckenzirkel	931
Aortastanzen	811	BECKMANN Nasenspekulas	662
ARKANSAS Abziehstein	58	BECKMANN Ringmesser	628
Arm-System	478, 479	BECKMANN Wundspreizer, selbsthaltend	459
ARRUGA Nadelhalter	496	BECKMANN-ADSON Wundspreizer, selbsthaltend	462
ARRUGA TC Nadelhalter	531	BECKMANN-EATON Wundspreizer, selbsthaltend	463
Arterienklemmen	238-260	BEEBEE Drahtscheren	148
Abdominal KIT II	481	BEER Cilienpinzetten	223
ASCH Sekretlöffel	911	BEESON Gipsspreizer	1193
ASH Septumzangen	698	Behälter	1212-1217
Ästhesiometer	20	Beinhautmesser	53
Atraumatische Gefäßklemmen	299-346	BELLUCCI Mikro-Ohrscherchen	740
Atraumatische Pinzetten	218-220	BENNETT Knochenheber	1082
Atrial Blatt Einführungs-zange	820	BENGOLEA Arterienklemmen	243, 255
Atrial Blätter	820	BENSAUDE Anuskope	862
Atrial Blatthalter	820	BENSON Darmklemmen	852
Atrial Haken	792, 797, 824	Bereitschaftskästen	1225
		BERGER Uterus-Biopsiezangen	920



BERGMANN Anatomische Skalpelle	51	BROWN Gewebefasspinzetten	217
BERGMANN Gipssägen	1195	BROWN Nadelhalter	490
BERGMANN Hämmer	1015	BRUENINGS Broncho-Oesophagoskopiezangen	637
BERGMANN Verband- und Gipsscheren	1190	BRUENINGS Ohrclupen	727
BERGMANN Wundhaken	434	BRUENINGS Septummesser	672
BERLIN Biopsieküretten	913	BRUENINGS Septumzangen	697
BERLIN Schlauchklemmen	370	BRUENINGS Tonsillennmesser	57
BERLINER Perkussionshämmer	16	BRUENINGS Tonsillenschnürer	623
BERNHARD Tuchklemmen	368	BRUENINGS Verlängerungsrohre	636
Bertilon Messzirkel	20	BRUENINGS Zungenspatel	600
Beschneidungsinstrumente	956	BRUENINGS-BRUNK Nasenhaken	687
BETHUNE Rippenscheren	765	BRUENINGS-LUCAS Flachmeißel	1029
BEYER Hohlmeißelzangen	1130, 1133	BRUENINGS-LUCAS Hohlmeißel	1029
Biegeinstrumente	1170	BRUNETTI Meißel	1049
BIEMER Gefäßspreizer	827	BRUNNER Führungshohlsonden	509, 511
BILL Zughebel	936	BRUNNER Rektum-Anastomoseklemmen	855
BILLEAU Ohrschlingen	729	BRUNNER Rippenscheren	768
Biopsieküretten	912-914	BRUNNER Unterbindungsnadeln	502, 509
Biopsienasenzangen	755	BRUNNER Wundhaken	396-398, 415
BIRCHER Meniskus- und Knorpelfaßzangen	1145	BRUNS Scharfe Löffel	1095, 1106, 1107
BIRCHER Meniskusmesser	1147	BRUNS Verband- und Gipsscheren	1190, 1191
BIRCHER Wund- und Meniskushaken	1148	Bruststütze	638
BIRCHER-GANSKE Meniskus- und Knorpelfaßzangen	1145, 1146	Bruststütze für alle Mundsperrer	617
BIRKETT Arterienklemmen	249	BRYANT Kornzangen	352
BLAKE Gallensteinzangen	877	BUCHWALD Zungenspatel	600
BLAKESLEY Nasenzangen	757	BUCK Fremdkörperzängchen	731
BLAKESLEY-WIGAND Nasenzangen	991	BUCK Ligaturscheren	147
Blasenhalsspreizer	953	BUCK Myringotom	735
Blasenspatel	953	BUCK Ohrküretten	728
Blasenwundspreizer	952	BUCK Perkussionshammer	16
Blattosteotome	1035	BUCK-GRAMCKO Knochenhebel	1075
Bleihände	1182	BUECHS Raspatorien	1063
BLOHMKE Tonsillenfasszangen	621	BUELAU Trokare	70
BLOUNT Wund- und Meniskushaken	1149	Bulldogklemmen	288-297
BLUMENTHAL Hohlmeißelzangen	1128	BUMM Polypen und Ovarienzangen	356
Blutdruckmessgeräte	24-25	BUMM Uterusküretten	928, 929
Blutschnäpper	29	BUNNELL Handbohraparate	1172
BOEHLER Hohlmeißelzangen	1132	BUNNELL Sehnenschäler	1152, 1153
BOEHLER Knochensplitterzangen	1142	BUNT Sterilisierklammern	372
BOERMA Geburtszangen	934	BURFORD Rippensperrer	775-777
BOETTCHER Tonsillenscheren	116	BURKE Uterus-Biopsiezangen	920
Bohrführungsinstrumente	1012	BUSCH Nabelschnurschere	102
Bohrhandgriffe	1156, 1157	BUSHE Scharfe Löffel	1113
BOIES Nasenfraktur Elevatorien	698	C	
BONACCOLTO Nahtpinzetten	198	CAIRNS Arterienklemmen	251
BONN Feine chirurgische Scheren	129	CANADIAN Meniskusmesser	1147
BONN Mikropinzetten	227	CAPLAN Septumscheren	700
BONNEY Anatomische Pinzetten	203	CARDIOBASE Rippensperrer	798, 799
BONNEY Anatomische TC Pinzetten	233	CARDIOPHONE Stethoskop	19
BONNEY Chirurgische Pinzetten	215	CARMALT Splitterpinzetten	225
BONNEY Chirurgische TC Pinzetten	235	CAROLL Finger-Goniometer	20
BONNEY Darm- und Gewebefaßzangen	360	CAROLL Sehnendurchziehungen	1151
BOROWSKI Aortahaken	817	CARPENTER Tonsillendissektoren	622
BOSE Trachealhäkchen	655	CARPENTER Tonsillennmesser und Enukeleator	622
BOSE Wundspreizer, selbsthaltend	445	CARREL Arterienklemmen	251
BOUCHERON Ohrspekulas	723	CASPAR Cervicale Wirbelkörperdistractionssystem	560, 561
BOWLES Stethoskop	18	CASPAR Dissektor	832, 833
BOWMAN Tränenkanalsonden	62	CASPAR Explorations- & Koagulationshäkchen	834
BOYNTON Nadelhalter	497	CASPAR Fadengabel	828
BOYS-ALLIS Darm- und Gewebefaßzangen	365	CASPAR Küretten	1110
BOZEMANN Gefäßschere	131	CASPAR Laminektomie-Spreizer	564-567
BOZEMANN Nadelhalter	493	CASPAR Laminektomie-Zangen	987, 1000-1004
BOZEMANN Tamponzangen	353	CASPAR Laminektomie-Zangen, zerlegbar	1002, 1003
BOZEMANN TC Nadelhalter	526	CASPAR Messschieber	559
BOZEMANN-DOUGLAS Tamponzangen	353	CASPAR Nervwurzelhaken	552
BRAND Sehnendurchziehungen	1152	CASPAR Raspatorien	562, 563
BRAUN Dekapitationshaken	937	CASPAR Scharfe Löffel	1101-1103
BRAUN Hakenzangen	901, 908	CASPAR Skalpellgriffe	825
BRAUN Kranioklast	938	CASPAR Spekulas für lumbale Bandscheibenoperationen	585
BRAUN Scheidenspekulas	892	CASPAR Stößel	1024
BRAUN Uterus-Depressor	900	CASPAR Wundhaken	388
BRAUN-STADLER Damm Scheren	101	CASPAR Wundspreizer für die cervicale Wirbelsäule	568-579
BRAUN-STADLER Episiotomie Scheren	101	CASPAR Wundspreizer für die lumbale Wirbelsäule	582, 584
BREISKY Scheidenspekulas	894	CASTANEDA Neonatal-Gefäßklemmen	298-299
BREISKY WIENER Scheidenspekulas	894	CASTANEDA Rippensperrer	773, 774
BRIDGE Präparier- und Ligaturklemmen	264	CARSTENS Trokare	70
BRODIE Hohlsonden	64	CASTROVIEJO Klängenbrecher	47
BROM Wundhaken	431	CASTROVIEJO Klängenhalter	47
Broncho-Oesophagoskopiezangen	636	CASTROVIEJO Mikropinzetten	226
Bronchoskopie	658, 659	CASTROVIEJO Mikro-Scheren	138, 139
Bronchusklemmen	802	CASTROVIEJO Tränenkanalsonden	63
BROPHY Anatomische Pinzetten	202	CATLIN Amputationsmesser	52
BROPHY Chirurgische Pinzetten	214	CAWOOD-MINNESOTA Lippen- und Wangenhalter	618

Cerclage-Instrumente	1158	CORWIN Drahtzangen	1160
Cerlage Draht	1157	CORYLLOS Rippenscheren	766
Cervicales Wirbelkörperdistractionssystem	560, 561	CORYLLOS Wundhaken	395
CHADWICK Feine chirurgische Scheren	123	COTTLE Columellapinzette	686
CHAPUT Darm- und Gewebefäßzangen	366	COTTLE Fixierpinzette	686
CHARNLEY Bauchdeckenhalter	475	COTTLE Flachmeißel	680, 681
CHARRIÈRE Amputations- und Resektionssägen	1009	COTTLE Hämmer	1013
CHEATTLE Sterilisierzangen	1209	COTTLE Knorpelquetsche	686
CHELSEA Proktoskope	862	COTTLE Nasenflügelhäkchen	688, 689
CHERON Tupferzangen	354	COTTLE Nasenhaken	690
CHEVALIER Rippensperrer	781	COTTLE Nasenplastikmesser	673
CHEVALIER-JACKSON Tracheal-Kanülen	655	COTTLE Nasenraspeln	1084
CHILDE Wundklammerpinzetten	517	COTTLE Nasenscheren	120, 122
Chirurgische Nadeln	514-516	COTTLE Nasenspekulas	666-668
Chirurgische Pinzetten	205-218	COTTLE Osteotome	680, 1031
Chirurgische Scheren	91-97, 103-105, 151-153	COTTLE Raspatorien	1060
Chirurgische SCT Scheren	186, 187	COTTLE Septumlevatorien	677, 678
Chirurgische TC Scheren	162, 165, 167	COTTLE TC Tonsillenscheren	174
CHURCH Gefäßscheren	132	COTTLE-KAZANJIAN Knochensplitterzangen	1141
Cilienpinzetten	223	COTTLE-KNAPP Nasenscheren	122
CINELLI Osteotome	683	COTTLE-MASING Nasenscheren	122
CITELLI Laminektomie-Stanzen	958	COTTLE-NEIVERT Nasenflügelhäkchen	689
CITELLI-BEYER Laminektomie-Stanzen	958	COTTLE-WALSHAM Septumzangen	698, 699
CLAR Stirnlampen	26	COUPLAND Saugrohre	82
CLASSON Gefäßscheren	132	CRAFOORD Gynäkologische Scheren	101
CLAUS V. EICKEN Tonsillennadel	626	CRAFOORD Präparier- und Ligaturklemmen	266
CLEVELAND Hohlmeißelzangen	1128	CRAFOORD-SELLORS Präparier- und Ligaturklemmen	266
CLEVELAND Knochensplitterzangen	1141	CRAIG Septumzangen	696
CLOVER Tonsillenfasszangen	620	CREDO Hornhauthobel	1207
CLOWARD Laminektomie-Zangen	1006	CRILE Arterienklemmen	248, 258
CLOWARD Nervwurzelhaken	553	CRILE Nadelhalter	497
CLOWARD Wirbelkörperspreizer	592, 593	CRILE Wundhaken	419, 430
CLOWARD Wundspreizer für die cervicale Wirbelsäule	580, 581	CRILE-MURRAY Nadelhalter	490
COAKLEY Kieferhöhlenküretten	690-692	CRILE-RANKIN Arterienklemmen	246, 257
COAKLEY Kieferhöhlentroker	71	CRILE-WOOD Nadelhalter	490
COBB Elevatorien	1072, 1073	CRILE-WOOD TC Nadelhalter	522
COBB Küretten	1112	CRUTCHFIELD Schädelhalter	548
COBB Spinal Hohlmeißel	1050	CUSCO Scheidenspekulas	880-882
COBETT Dermatome	59	CUSHING Anatomische Pinzetten	202
COBRA Atraumatische Gefäßklemmen	318	CUSHING Anatomische TC Pinzetten	233
COEN Uterus Känule	915	CUSHING Chirurgische Pinzetten	213
COHEN Raspatorien	1055	CUSHING Durahaken	555
COLCLOUGH Laminektomie-Stanzen	984	CUSHING Hirnspatel	543
COLLER Arterienklemmen	246	CUSHING Laminektomie-Zangen	995, 998
COLLIER Nadelhalter	492	CUSHING Wundhaken	430, 437, 441, 444
COLLIN Bauchdeckenhalter	466, 467	CUSHING-BROWN Chirurgische Pinzetten	216
COLLIN Beckenzirkel	931	CUSHING-KOCHER Wundhaken	437
COLLIN Darm- und Gewebefäßzangen	361	CUSHING-LANDOLT Spekulas für Hypophysektomie	702
COLLIN Dynamometer	20	CUZZI Plazenta- und Abortuslöffel	942
COLLIN Hämmer	1016	CZERNY Analspreizer	861
COLLIN Kornzangen	354	CZERNY Hakenzangen	906
COLLIN Nabelschnurklemmen	937	CZERNY Wundhaken	420
COLLIN Organfasszangen	358	D	
COLLIN Scheidenspekulas	880	DAHLGREN Schädelzangen	549
COLLIN Skalpgriffe	47	DAHMEN Hohlmeißel	1051
COLLIN Uterusfaßzangen	910	DAHMEN Osteotome	1051
COLLIN Wundhaken	420	DALE Atraumatische Gefäßklemmen	329
COLLIN Wundklammerzangen	518	Damm Scheren	101, 102, 152
COLLIN Zungenzangen	618	Damm TC Scheren	162
COLLIN-DUVAL Fasspinzette	204	DANDY Arterienklemmen	249, 258
COLLIN-HARTMANN Wundhaken	416	DANDY Durahaken	554
COLLIN-LOKTITE Bauchdeckenhalter	467	DANDY Gefäßscheren	132
COLLYER Beckenzirkel	931	DARDIK Atraumatische Gefäßklemmen	346
Columellapinzette	686	DARLING Wundspreizer, selbsthaltend	452
CONE Ringküretten	1111	Darm- und Gewebefäßzangen	360-366
CONE Schädelzangen	549	Darm- und Magenklemmen	860
CONVERSE Nasenflügelhäkchen	688	Darmklemmen	844-854
CONVERSE Nasenhaken	687	Darmscheren	103
CONVERSE Nasenplastikmesser	673	DARTIGUES Uterusfaßzangen	909
CONVERSE Osteotome	682	DAUBENSPECK Scharfe Löffel	1099
COOLEY Aorta-Dilatatoren	810	DAUTREY-MUNRO Osteotome	1034
COOLEY Atraumatische Gefäßklemmen	304, 305, 326, 330, 335-339, 342-345	DAVIDSON Wundhaken	411
COOLEY Atraumatische Pinzetten	219, 220	DAVIS Intimaspatel	813
COOLEY Atrial Haken	797	DAVIS Sterilisierzangen	1209
COOLEY Atriumhaken	816	DAVIS-BOYLE Mundsperrer	608-612
COOLEY Gefäßdilatatoren	808	DAVIS-BOYLE Zungendrucker	616
COOLEY Rippensperrer	769-771, 788, 789	DAVIS-MEYER Mundsperrer	607
COOLEY Saugrohre	83	DAVIS-MEYER Zungendrucker	616
COOLEY-BECK Atraumatische Gefäßklemmen	340	DAY Ohrhäkchen	731
COOLEY-LEITZ Atraumatische Gefäßklemmen	340	DE BAKEY Atraumatische Gefäßklemmen	300-303, 309-311, 313, 314, 316, 317, 321, 322, 325, 328, 330
COOPER Unterbindungsnadeln	502	DE BAKEY Atraumatische Pinzetten	219, 220
COPE Wundhaken	440	DE BAKEY Atraumatische TC Pinzetten	236
CORDES Broncho-Oesophagoskopiezangen	637		



DE BAKEY Bulldogklemmen	288, 289	DOYEN Polypen und Ovarienzangen	356
DE BAKEY Gefäßdilatoren	809	DOYEN Raspatorien	1066, 1067
DE BAKEY Gefäßscheren	134, 135	DOYEN Scheidenspekulas	893
DE BAKEY Präparierscheren	115	DOYEN Tuchklemmen	368
DE BAKEY Rippensperr	786, 787	DOYEN Wundhaken	402
DE BAKEY Saugrohre	84	DOYEN Zungendrücker	602
DE BAKEY TC Gefäßscheren	179	DOYEN-CHILD Bauchdeckenhalter	480
DE BAKEY TC Nadelhalter	522, 523	DOYEN-COLLIN Mundsperr	603
DE BAKEY Wundspreizer, selbsthaltend	464	DOYEN-JANSEN Mundsperr	603
DE BAKEY-BAHNSON Atraumatische Gefäßklemmen	310	DOYEN-STILLE Wundhaken	408
DE BAKEY-BECK Atraumatische Gefäßklemmen	305	DRAFFIN Halterahmen für Mundsperr	617
DE BAKEY-CAROTIS Bulldogklemmen	297	Drahtgeflecht	1155
DE BAKEY-DIETHRICH Bulldogklemmen	294	Drahtkneifzangen	1164-1170
DE BAKEY-MIXTER Atraumatische Gefäßklemmen	300	Drahtsägen	1010
DE BAKEY-MOSQUITO Atraumatische Gefäßklemmen	307	Drahtscheren	148
DE BAKEY-PEAN Atraumatische Gefäßklemmen	306	Drahtumführungsadeln	1158, 1159
DE BAKEY-RANKIN Atraumatische Gefäßklemmen	307	Drahtzangen	1159-1163
DE BAKEY-RUMEL Atraumatische Gefäßklemmen	300	DUBOIS Kephalotomieschere	100
DE BAKEY-SATINSKY Atraumatische Gefäßklemmen	331	DUEHRSEN Anatomische Pinzetten	203
DE BAKEY-SATINSKY Bulldogklemmen	297	DUEHRSEN Chirurgische Pinzetten	215
DE LEE Geburtszangen	932	DUKE Trokare	71
DE MARTEL Einführungsinstrumente	549	DUNN-DAUTREY Osteotome	1026
DE MARTEL-WOLFSON Anastomoseklemmen	845	DUPLAY Hakenzangen	902
DE MARTEL-WOLFSON Klemmenhalter	845	DUPLAY Kornzangen	351, 352
DE MARTEL-WOLFSON Klemmenschießzange	845	DUPLEX Stethoskope	18
DE VILBISS Schädelzangen	549	DUPUY-WEISS Unterbindungsadeln	626
DEAN TC Tonsillenscheren	174	Dura-Dissektoren	550, 551, 812, 813
DEAN Tonsillenscheren	116	Durahaken	554, 555
DEAVER Chirurgische Scheren	96	Duramesser	57, 58, 553
DEAVER Wundhaken	426, 427, 485	DURANTE Gefäß- und Tumorpinzetten	218
DECKER Laminektomie-Zangen	1006	DUVAL Darm- und Gewebefäßzangen	360, 361
Deckglaspinzetten	226	DUVAL Fasspinzetten	204
DEJERINE Perkussionshämmer	16	DUVAL-COLLIN Darm- und Gewebefäßzangen	361
Dekapitationshaken	937	Dynamometer	20
DEMEL Cerclage-Instrumente	1158	E	
DEMEL Drahtumführungsadeln	1158	ECHLIN Hohlmeißelzangen	1135
DENHARDT Mundsperr	603	EDER Watteträger	66
DENNIS-BROWNE Bauchdeckenhalter	471	EICKEN Kieferhöhlenspülkanülen	88
DENNIS-BROWNE Gewebefasspinzetten	204	Einführungsinstrumente	549
DERF (WRIGHT) Nadelhalter	491	Einführungszängchen für Teflonprothesen	742
DERF TC Nadelhalter	525	Einmal-Skalpelle	49
DERF-CONVERSE Nadelhalter	492	EISELSBERG Ligaturscheren	147
DERF-CONVERSE TC Nadelhalter	525	EISELSBERG Nadelhalter	497
Dermatologie	60, 61	Elevatoren	737, 840, 1052-1056, 1072-1074
Dermatome	59	ELSAESSER Nierenfistelzangen	876
DERRA Atraumatische Gefäßklemmen	304	EMMET Kornzangen	354
DESCHAMPS Unterbindungsadeln	503-508	EMMET Wundhaken	436
DESJARDINS Gallensteinlöffel	873	Empyema Trokar	70
DESJARDINS Gallensteinsonden	872	Endolaryngeale Mikrochirurgie	642-651
DESJARDINS Gallensteinzangen	878	Endospekulas	896
DESJARDINS Nierenstielklemmen	282	ENGEL Gips sägen	1195
DESMARRES Wundhaken	436	Enukleatoren	705
Diagnostik Bestecke	30-35	Epikardial Retraktoren	817
DICK Hysterektomie klemmen	276	Episiotomie Scheren	101, 102, 152
DIEFFENBACH Bulldogklemmen	292	Episiotomie TC Scheren	162
DIETER Hammerkopfstangen	744	EPENDORF Uterus-Biopsiezangen	920, 922
DIETRICH Bulldogklemmen	291	ESMARCH Gipsmesser	1195
DIETRICH Atraumatische Gefäßklemmen	334	ESMARCH Verband- und Gips scheren	1190
DIETRICH-VASCULAR TC Nadelhalter	532	EVES Tonsillenschnürer	623
Dilatationsbougies	949, 950	EWALD Anatomische Pinzetten	198
DINGMANN Knochenhalte zange	1117	EWALD Chirurgische Pinzetten	209
DINGMANN Mundsperr	606	Exkavator	747
DINGMANN Zungendrücker	615	Explorations- & Koagulationshäkchen	834
DIPLOMAT Blutdruckmessgeräte	25	Extensionsbügel	1154, 1155
Dissektomie-Spreizer	594	F	
Dissektoren	703, 708, 753, 831, 832, 835, 840, 1052, 1056	Face-lift Scheren	117
Distractionsklammer für Knochenhalteklammern	1126	Face-lift SCT Scheren	190
Diszisionsmesser	745	Face-lift TC Scheren	175, 176
DITTEL Katheterspanner	947	Fadenfänger	513, 627, 815, 822
DIXON-LOVELACE Arterienklemmen	247, 257	Fadenführer	829
DOCKHORN Wundhaken	387	Fadengabeln	513, 827, 828
Doppelsonden	827	FAHLBUSCH Kürette	707
Dosen	1214	FAHLBUSCH Löffel	707
DOUAY Uterus-Biopsiezangen	920	FAHLBUSCH Mikro-Schere	651
DOUGHTY Zungendrücker	615	FANSLER Anuskope	862
DOUGLAS Cilienpinzetten	223	FARABEUF Knochenhalte zange	1120
DOUGLAS Kieferhöhlentroker	71	FARABEUF Raspatorien	1063
DOYEN Bauchdeckenhalter	480	FARABEUF Wundhaken	417
DOYEN Bauchdeckenscheren	97, 98	FARABEUF-COLLIN Raspatorien	1063
DOYEN Darmklemmen	844-847	FARABEUF-LAMBOTTE Knochenhalte zange	1120
DOYEN Hohlsonden	63	FARRELL Watteträger	65
DOYEN Myomheber	908	FARRIOR Ohrspekulas	720, 724
DOYEN Nadelhalter	492	Fasspinzetten	204



FAULKNER Kieferhöhlenküretten	690	Fremdkörperheber	731
FAURE Hysterektomieklappen	272	Fremdkörperinstrumente	731
FAURE Peritoneumklappen	278	Fremdkörperzangchen	731
FAURE Uterus-Biopsiezangen	916	Fremdkörperzangen	948
FAVALORO Gefäßscheren	134	FRENZEL Zungenspatel	600
FAVALORO Rippensperrerr	775	FRIEDMANN-JOLL Vulvaspreizer	896
FEHLAND Rektum-Anastomoseklappen	856	FRIEDMANN-MINI Hohlmeißelzangen	1127
FEILCHENFELD Splitterpinzetten	225	FRIEDMANN-VICKERS Hohlmeißelzangen	1127
FEIN Watteträger	633	FRITSCH Wundhaken	403
Feine chirurgische Scheren	123-130, 156-157	FRY Nasenzangen	990
Feine chirurgische SCT Scheren	190	FRYKHOLM Hohlmeißelzangen	1136
Feine chirurgische TC Scheren	177, 178	FUCHSIG Arterienklappen	247
FELDHEIM Kompressorium	1181	Führungsgabeln	747, 752
Fenestrierhäkchen	747	Führungshohlsonden	509-513
FERGUSON Chirurgische Scheren	97	Führungsnadeln	66-68
FERGUSON Darmklappen	853	FULLER Einführungsängchen für Teflonprothesen	742
FERGUSON Gallensteinlöffel	874	Furunkelmesser	735
FERGUSON Knochenhaltezeuge	1119	G	
FERGUSON Rektum-Anastomoseklappen	855	Galeahaken	545
FERGUSON Saugrohre	78, 79	GALLAHER Nasenraspeln	1085
FERGUSON-ACKLAND Mundsperrerr	603	Gallenblasenlöffel	873
FERRIS-SMITH Chirurgische Pinzetten	215	Gallenblasentroker	71
FERRIS-SMITH Chirurgische TC Pinzetten	235	Gallenkanaldilatatore	872
FERRIS-SMITH-CUSHING Laminektomie-Zangen	979-983	Gallensteinlöffel	873, 874
FERRIS-SMITH-CUSHING Laminektomie-Zangen, zerlegbar	981, 983	Gallensteinsonden	872, 873
FERRIS-SMITH-KERRISON Laminektomie-Stanzen	960-967, 978	Gallensteinzangen	877, 878
FICKLING Präparier- und Ligaturklappen	269	GARDNER Knochensplitterzangen	1141
FILIFORM Dilatationsbougies	949	GARRETT Gefäßdilatatore	809
Finger-Goniometer	20	GAST Zungendrucker	615
Fingerringhäkchen	689	Gaummennadeln	626
Fingerringssägen	1011	Gaumensegelhalter	627
Fingerschutz	619	GAUSS Kopfschwartzange	936
Finger-Wundspreizer	1183	Geburtslöffel	936
FINOCHIETTO Nadelhalter	494	Geburtszangen	932-935
FINOCHIETTO Präparier- und Ligaturklappen	280	Gefäß Spülkanülen	73
FINOCHIETTO Rippensperrerr	771-773, 784, 785	Gefäß- und Tumorzangen	214, 216, 218
FINOCHIETTO TC Nadelhalter	527	Gefäßdilatatore	808, 809, 827
FINSSEN Wundspreizer, selbsthaltend	445	Gefäßdissektore	814
FINSTERER Saugrohre	84	Gefäße	1212-1217
FISCHER Sehnenschäler	1153	Gefäßmesser	827, 838
FISCHER Tonsillennmesser	623	Gefäßscheren	115, 117, 131-137, 158
Fistelmesser	56	Gefäßspreizer	827
Fixationsklappen	946	GELFOAM Septumzange	701
Fixierpinzette	686	GELLHORN Uterus-Biopsiezangen	919
Flachmeißel	680-682, 751	GELPI Wundhaken	485
Flachmeißel	1025-1051	GELPI-LOKTITE Wundspreizer, selbsthaltend	456, 457
Flexibles Naso-Pharyngo-Laryngofiberskop	598	GELPI-SEILETZ Wundspreizer, selbsthaltend	457
FOERSTER Schwammzangen	359	GEMINI Präparier- und Ligaturklappen	265
FOERSTER-BALLENGER Schwammzangen	359	GERALD Anatomische Pinzetten	202
Foetal-Stethoskope	17	GERALD Anatomische TC Pinzetten	233
FOMON Fingerringhäkchen	689	GERALD Chirurgische Pinzetten	214
FOMON Nasenflügelhäkchen	688, 689	GERALD Chirurgische TC Pinzetten	235
FOMON Nasenplastikmesser	672	GERALD Ohr- und Nasenpinzetten	222
FOMON Nasenraspeln	1086, 1090	GERALD-BROWN Chirurgische Pinzetten	216
FOMON Nasenscheren	118, 119, 121	GERSTER Distraktionsklammer für Knochenhalteklappen	1126
FOMON Osteotome	683	GERZOG Hämmer	1017
FOMON SCT Nasenscheren	189	GERZOG-SEXTON Parazentesenadel	735
FOMON TC Tonsillenscheren	174	Gewebefasspinzetten	203, 204, 209, 217
FORD-DIXON Hämorrhoidal-Ligatore	868	Gewebekralle	830
FORMBY Zerumenlöffel und Häkchen	730	GIERTZ-STILLE Rippenscheren	767
FOSTER-GILLIES TC Nadelhalter	528	GIGLI Drahtsägen	1010
FOWLER Tonsillennmesser	57	GIGLI Handgriff für Drahtsägen	1010
FOX Lupusküretten	60	GILLIES Anatomische Pinzetten	199
FRAENKEL Broncho-Oesophagoskopiezangen	637	GILLIES Chirurgische Pinzetten	211
FRAENKEL Kehlkopfpolypezangen	634, 635	GILLIES Chirurgische TC Pinzetten	234
FRANCKE Blutschnäpper	29	GILLIES Nadelhalter mit Schere	495
FRANZ Bauchdeckenhalter	474	GILLIES Osteotome	1026
FRASER-KELLY Arterienklappen	248	GILLIES TC Nadelhalter	528
FRAZIER Dura-Dissektore	551	GILLIES Wundhaken	442
FRAZIER Durahaken	555	GILLIES-MINI TC Nadelhalter	528
FRAZIER Hirnventrikelpunktionskanüle	80	GILL-VERNET Wundhaken	438
FRAZIER Saugrohre	77	Gipsmesser	1195
FREEMAN-GORNEY Face-lift TC Scheren	176	Gipssägen	1195
FREEMAN-KAYE Face-lift TC Scheren	176	Gipsspreizer	1193, 1194
FREER Elevatorien	1054	GLASSMANN Atraumatische Pinzetten	218
FREER Flachmeißel	1025	GLOVER Atraumatische Gefäßklappen	303, 315, 316
FREER Hohlmeißel	1025	GLOVER Bulldogklappen	290, 296
FREER Mukosamesser	673	GLUCK Rippenscheren	764
FREER Septumelevatorien	674, 675	GOLDMANN Nasenfraktur Elevatorien	698
FREER Wundhaken	443	GOLDMANN-FOX TC Zahnfleischscheren	177
FREER-GORNEY Saugelevator	674	GOLDMANN-FOX Zahnfleischscheren	125
FREER-JOSEPH Septumelevatorien	675	GOELET Wundhaken	418
FREER-YASARGIL Septumelevatorien	674	GOMEL Mikro-Schere	143



GOOD Tonsillenscheren	117	HARTMANN Arterienklemmen	250
GOOD-SCHWEKENDIECK Tonsillenscheren	117	HARTMANN Darmklemmen	846
GORNEY Face-lift TC Scheren	175	HARTMANN Hohlmeißelzangen	1129
GORNEY Präparierscheren	113	HARTMANN Nasenspekulas	661, 662
GORNEY-FREEMAN Face-lift TC Scheren	176	HARTMANN Nasenzangen	992
GOSSET Bauchdeckenhalter	469	HARTMANN Ohrhäkchen	731
GOSSET-BABY Bauchdeckenhalter	469	HARTMANN Ohrkatheter	716
GOURDET Uteruslöffel	924	HARTMANN Ohrpolypenzangen	732
GRAEFE Anatomische Skalpelle	51	HARTMANN Ohrspekulas	721-723
GRAEFE Feine chirurgische Scheren	129	HARTMANN Ohrzängchen	732, 733
GRAEFE Gewebefasspinzetten	209	HARTMANN Stimmgabeln	713-715
GRAEFE Hautfasspinzette	686	HARTMANN Tampon- und Polypenzangen	669, 670
GRAEFE Irispinzetten	197, 208	HARTMANN Watteträger	633
GRAEFE Wundhaken	429, 431	HARTMANN Zungendrucker	601
GRAHAM Durahaken	554	HARTMANN-HALLE Nasenspekulas	661
GRAVE Scheidenspekulas	883, 884, 886, 887	HARTMANN-HOFFMANN Ohrzängchen	733
GRAY Präparier- und Ligaturklemmen	280	HARTMANN-NOYES Ohrzängchen	733
GREEN-ARMYTAGE Uterusklemmzange	936	HARTMANN-WEINGAERTNER Ohrzängchen	733
GREGORY Atraumatische Gefäßklemmen	326	HARTMANN-WULLSTEIN Ohrzängchen	732
GREGORY Face-lift SCT Scheren	190	HARVEY Drahtscheren	148
GREGORY Face-lift TC Scheren	175	HARVEY-JACKSON Wundspreizer, selbsthaltend	463
GREGORY-SOFT Bulldogklemmen	297	HASLINGER Gaumensegelhalter	627
GREVEN Mikro-Drahtbiegezängchen	741	HASOBUCCHI Gabel	706
GREY-TURNER Arterienklemmen	256	HATFIELD Scharfe Löffel	1112, 1113
GRONINGEN Durahaken	554	Hautfasspinzette	686
GROSS Kornzangen	350, 351	Hauttrephine	60, 61
GROSS Ohrschlingen	730	HAYES Rektum-Anastomoseklemmen	857
GROSS-MAIER Kornzangen	349, 350	HEANEY Hysterektomieklappen	274
GRUBER Ohrspekulas	725	HEANEY Nadelhalter	492
GRUENWALD Nasenzangen	757	HEANEY TC Nadelhalter	526
GRUENWALD Zerstäuber	761	HEANEY-RAZAK Hysterektomieklappen	274
GRUENWALD-HENKE Nasenzangen	991	HEANLEY Hohlmeißelzangen	1127
GRUENWALD-JANSEN Ohr- und Nasenpinzetten	222	HEART-GATE Atrial Blatt Einführungszange	820
GUILLEN Saugelatorien	678	HEART-GATE Atrial Blätter	820
GUILFORD-WRIGHT Drahtscheren	148	HEART-GATE Atrial Blatthalter	820
GULEKE Hohlmeißelzangen	1131	HEART-GATE Atrial Haken	792, 793
GUNAR-HEY Schlauchklemmen	371	HEART-GATE Fadenfänger	822
GUSTELLA Osteotome	684	HEART-GATE Instrumente für minimalinvasive Chirurgie	818-823
GUTHRIE Wundhaken	432	HEART-GATE Kardioplegie-Kanüle	823
GUYON Dilatationsbougies	949	HEART-GATE Magnetstab	822
GUYON Katheterspanner	947	HEART-GATE Naht Lineal	823
GUYON Nierenstielklemmen	282-284	HEART-GATE Nerv- und Gefäßhaken	822
GWYNE-EVANS Tonsillendissektoren	623	HEART-GATE Rippensperrerr	791, 792
Gynäkologische Scheren	98-102	HEART-GATE Skalpelgriff	823
Gynäkologische TC Scheren	162	HEATH Hämmer	1015
H		HEATH Ligaturscheren	147
HABERER Bauch- und Darmspatel	421	HEGAR Nadelhalter	488
HACKSTOCK Drahtzangen	1161	HEGAR TC Nadelhalter	521
HAGLUND-STILLE Gipsspreizer	1193	HEGAR Uterus-Dilatatoren	897, 898
HAIGHT Rippensperrerr	781	HEGAR-BAUMGARTNER Nadelhalter	490
HAJEK Hämmer	1013	HEGAR-BAUMGARTNER TC Nadelhalter	524
HAJEK Nasenzangen	991	HEGAR-VASCULAR TC Nadelhalter	532
HAJEK Saugrohre	87	HEGEMANN-DIETRICH Gefäßscheren	137, 158
HAJEK-CLAUS Laminektomie-Stanzen	958	HEGEMANN-DIETRICH SCT Gefäßscheren	191
HAJEK-KOFLER Laminektomie-Stanzen	959	HEGEMANN-DIETRICH TC Gefäßscheren	180
HAKANSSON Hohlmeißelzangen	1128	HEGENBARTH Wundklammerpinzetten	517
Häkchen	706, 708, 747, 748, 750, 752, 753, 831, 832, 841	HEIFETZ Hirnspatel	543
Hakenzangen	901-908	HEIMING Nierenfistelzangen	874
HALLE Duramesser	553	HEISS Arterienklemmen	244, 256
HALLE Scharfe Löffel	1098	HEISTER Mundsperrerr	603
HALLE Septumelevatorien	674	HELFERICH-BIER Amputations- und Resektionssägen	1009
HALSEY Nadelhalter	491	HEMINGWAY Scharfe Löffel	1093
HALSEY TC Nadelhalter	524	HENDERSON Wundspreizer, selbsthaltend	449
HALSTED-MOSQUITO Arterienklemmen	244, 250, 256, 258, 259	HENKE Tonsillendissektoren	622
Halterahmen für Mundsperrerr	617	HENLEY Atraumatische Gefäßklemmen	331
Hämmer	751, 1013-1020	HENLEY Wundspreizer, selbsthaltend	450, 451
Hammerkopfstanzen	742, 744	HENNIG Gipsspreizer	1193
Hämorrhoidal-Ligatoren	866-868	Heparinnadeln	73
Handbohrapparate	1171-1173	HEPP-SCHIEDL Mikro-Scheren	143
Handgriff für Drahtsägen	1010	HERBERHOLD Zungendrucker	616
Handhalter	1182	HERMANN Flachmeißel	751
Handwaschbürsten	1227	HERMANN Hammer	751
HARDY Enukleatoren	705	HERMANN Hohlmeißel	751
HARDY Implantationsgabel	705	HERRICK Nierenstielklemmen	283
HARDY Kürette	707	HERTZLER Rippensperrerr	780
HARDY-FAHLBUSCH Dissektoren	703	HERZ Meniskus- und Knorpelfaßzangen	1145
HARGIS Unterkieferkörperhaken	1057	HERZ Sehnendurchziehungen	1150
HARGIS Vorderrandstripper	1057	HESS Bulldogklemmen	292
HARKEN Atraumatische Gefäßklemmen	334	HEY-GROVES Knochenhaltezege	1123
HARKEN Vena-Cava-Klemmen	348	HEYMANN Nasenscheren	120, 156
HARRINGTON Wundhaken	409, 485	HEYMANN SCT Nasenscheren	190
HARRINGTON-PEMBERTON Wundhaken	409	HEYMANN Septumzangen	696
HARTMANN (FRENCH) Stimmgabeln	713	HEYMANN-KNIGHT Tampon- und Polypenzangen	670



HEYWOOD-SMITH Polypen und Ovarienzangen	357	JAEGER Sehnendurchziehungen	1151
HIBBS Flachmeißel	1038	JAMESON Messzirkel	22
HIBBS Hohlmeißel	1039	JAMESON Nadelhalter	492
HIBBS Osteotome	1038	JAMESON Präparierscheren	114, 155
Hirnmesser	55	JAMESON SCT Präparierscheren	189
Hirnspatel	543, 544	JAMESON TC Präparierscheren	172
Hirnventrikelpunktionskanülen	80	JANET Spritzen	75, 76
HIRSCHMANN Anuskope	863	JANSEN Hohlmeißelzangen	1129, 1130
HOEN Dura-Dissektoren	551	JANSEN Ohr- und Nasenpinzetten	222
HOEN Laminektomie-Zangen	1007	JANSEN Ohrküretten	730
HOEN Raspatorien	1068	JANSEN Raspatorien	1060, 1064
HOEN V. EICKEN Fadenfänger	627	JANSEN Scharfe Löffel	1091, 1092
HOESEL TC Nadelhalter	530	JANSEN Stirnlampen	27
HOESEL Wundhaken	408	JANSEN Wundspreizer, selbsthaltend	446
HOFF Tuchklemmen	369	JATHO Nasenrachenzangen	631
Hohlmeißel	751, 1025-1051	JAVID Atraumatische Gefäßklemmen	326, 327
Hohlmeißelzangen	1126-1140	JENNINGS Mundsperrer	605
Hohlsonden	63	JIKEI Nasenzangen	759, 760
HOHMANN Knochenhebel	1077-1079	JOBSON-ZANGE Watteträger	65
HOKE Osteotome	1037	JOHN-HOPKINS Anlegezange für Bulldogklemmen	293
HOLINGER Operationslaryngoskope	641	JOHN-HOPKINS Bulldogklemmen	292, 293
HOLSHER Nervwurzelhaken	553	JOHNS-HOPKINS Präparier- und Ligaturklemmen	281
HOLZBACH Arterienklemmen	258	JONES Tuchklemmen	369
HOLZBACH Bauchdeckenhalter	475	JORGENSON Gefäßscheren	132
HOLZHEIMER Wundspreizer, selbsthaltend	445	JOSEPH Feine chirurgische Scheren	123
HOPKINS Gipsmesser	1195	JOSEPH Feine chirurgische SCT Scheren	190
Hornhauthobel	1207	JOSEPH Feine chirurgische TC Scheren	177
HORSLEY Nervwurzelhaken	552	JOSEPH Nasenplastikmesser	672, 673
HOUSE Mikro-Nadel	748	JOSEPH Nasenraspeln	1084
HOUSE Raspatorium	747	JOSEPH Nasensägen	685
HOUSE Saugrohre	86	JOSEPH Raspatorien	1053
HOUSE Scharfe Löffel	751	JOSEPH Septumelevatoren	677
HOUSE Trachealhäkchen	656	JOSEPH Septummesser	673
HOUSE-DIETER Hammerkopfstützen	742	JOSEPH TC Präparierscheren	172
HOWARTH Septumelevatoren	678	JOSEPH Wundhaken	443
HUBER Universalgriff	636, 923	JOSEPH-MASING Septumelevatoren	677
HUDSON Handbohrapparate	1172	JUDD-ALLIS Darm- und Gewebefaßzangen	365
HUGHES Steigbügelhäkchen	747	JUDD-MASSON Blasenwundspreizer	952
HUMBY Dermatome	59	JUERS Mikro-Drahtbiegezängchen	742
HUNTER Splitterpinzetten	225	JURASZ Kehlkopfpolypenzangen	634
HURD Gaumennadeln	626	JURASZ Nasenrachenzangen	631
HURD Tonsillendissektoren	622	K	
HUSFELDT Atraumatische Gefäßklemmen	327	KABIERSKE Pulverbläser	718
Hysterektomieklappen	271-276, 286	KADER Wundhaken	425
I		KAHN Face-lift Scheren	117
I.M.A. Mammaria Sperrer	794-797	KALLMORGEN Scheidenspekulas	891
Implantationsgabel	705	KALT Nadelhalter	497
INGE Wirbelkörperspreizer	592	KANE Nabelschnurklemmen	937
Injektionskanüle	72	KANTROWITZ Präparier- und Ligaturklemmen	266
Instrument für die Entfernung von Spiralen	911	Kapselzangen	955
Instrumente für minimalinvasive Chirurgie	818-823	Kapselscheren	105
Instrumente für schlagende Herzchirurgie	824	Kardioplegie-Kanülen	823
Instrumenten Pflegemittel	1227	KARLIN-CRANK Laminektomie-Spreizer	588
Instrumentenkästen	1216, 1217	Katheter-Einführungsinstrument	947
Instrumentenschalen	1215, 1216	Katheter-Einführungszangen	944
Insufflationskanülen	73	Katheterspanner	947
Interdentale Osteotome	1036	KATSCH Komedoneninstrument	61
Intimaspatel	813, 814	KATZIN Mikro-Scheren	142
Intubationsrohre	653	KATZIN-BARRAQUER Mikro-Scheren	142
IOWA Hakenzangen	905	KAYE Face-lift Scheren	118
IOWA Injektionskanülen	72	KAYE Face-lift TC Scheren	175
IRIS Feine chirurgische Scheren	127-129, 157	KAYE-MILLARD Wundhaken	444
IRIS Feine chirurgische SCT Scheren	191	Kehlkopfdeckelhalter	633
IRIS Feine chirurgische TC Scheren	178	Kehlkopfpolypenzangen	634, 635
Irispinzetten	197, 208	Kehlkopfspiegel	632
Irrigatoren	1215	Kehlkopf-Spritze	76
IRWIN Wundspreizer, selbsthaltend	456	Keilosteotome	1035
ISRAEL Wundhaken	380	KELLY Arterienklemmen	249
ITERSON Trachealhäkchen	655	KELLY Feine chirurgische Scheren	123, 156
IVES-FANSLER Anuskope	863	KELLY Feine chirurgische SCT Scheren	190
J		KELLY Feine chirurgische TC Scheren	177
JABALEY Feine chirurgische Scheren	130, 157	KELLY Polypen und Ovarienzangen	356
JACKSON Scheidenspekulas	893	KELLY Präparier- und Ligaturklemmen	270
JACKSON Sehnendurchziehungen	1150	KELLY Sphinkteroskope	863
JACKSON Trachealhäkchen	656	KELLY Wundhaken	406, 412, 413, 485
JACKSON-BURROWS Wundspreizer, selbsthaltend	457	KELLY-RANKIN Arterienklemmen	247
JACOBS Hakenzangen	906	KELMAN-MC PHERSON Mikropinzetten	227
JACOBSON Doppelsonde	827	Kephalotomieschere	100
JACOBSON Fadengabel	827, 828	KERN-LANE Knochenhaltezeuge	1119, 1121
JACOBSON Gefäßmesser	827, 838	KERPEL Scharfe Löffel	1114
JACOBSON Knopfsonde	827, 828	KERRISON Laminektomie-Stanzen	958, 976, 977
JACOBSON Scharfe Löffel	1091	KERSTING Rektum-Anastomoseklemmen	858
JAEGER Meniskus- und Knorpelfaßzangen	1145	KEVORKIAN Biopsieküretten	912



KEVORKIAN Uterus-Biopsiezangen	920, 922	Komedoneninstrument	61
KEVORKIAN-PACIFIC Uterus-Biopsiezangen	921	Kompressorium	1181
KEY Raspatorien	1068	Komprimeter	29
KEYES Hauttrephine	60	Konisationsmesser	56
Kieferhöhlenküretten	690-692	KONRICH Verbandstofftrommeln	1224
Kieferhöhlenlöffel	691, 692	KOOS Gefäßmesser	838
Kieferhöhlenpunktionskanüle	87	Kopfschwartzange	936
Kieferhöhlenraspeln	693	Kornzangen	349-352, 354, 355
Kieferhöhlenspülkanülen	88	KRAEMER Raspatorien	1063
Kieferhöhlentrokar	69, 70, 87	KRAEMER Wundhaken	388
KIELLAND Geburtszangen	933	Krampfaderbesteck	806, 807
KILLIAN Elevatorien	1055	Krampfaderinstrumente	815
KILLIAN Nasenspekulas	663-666	Kranioklast	938
KILLIAN Raspatorien	1055	KRAUS Gefäßmesser	838
KILLIAN Septumlevatorien	678	KRAUSE Broncho-Oesophagoskopiezangen	637
KILLIAN Septum-Hohlmeißel	679	KRAUSE Kieferhöhlentrokar	71
KILLIAN Septumscheren	700	KRAUSE Ohrpolypenschnürer	738
KILLIAN Tampon- und Polypenzangen	670	KRAUSE Polypenschnürer	671
KILLIAN Watteträger	633	KRAUSE-VOSS Ohrpolypenschnürer	738
KILLIAN-CLAUS Septum-Hohlmeißel	679	KRAUSE-VOSS Polypenschnürer	671
KILLIAN-RUDERT Nasenspekulas	665	KRAYENBUEHL Nerv- und Gefäßhaken	829
KILNER (RAGNELL) Präparierscheren	113, 155	KRESSNER Septumzangen	699
KILNER Feine chirurgische Scheren	126	KRISTELLER Scheidenspekulas	889-890
KILNER Nadelhalter	491	KRISTELLER WIENER Scheidenspekulas	891
KILNER Nasenflügelhäkchen	688	KROENLEIN Arterienklemmen	251
KILNER TC Nadelhalter	525	KRONECKER Unterbindungsnadeln	502
KILNER TC Präparierscheren	172	Kropffasszange	657
KILNER Wundhaken	419, 439, 442	Kropffonden	657
KILNER-DOUGHTY Mundsperrer	613	KUEHNE Deckglaspinzetten	226
Kinnhalter	383, 1057	KUEMMEL Wundhaken	401, 424
KIRK Hämmer	1017	KUESTNER Hakenzangen	904
KIRKLIN Wundhaken	438	Kugeldissektoren	840
KIRSCH Wundhaken	388	Küretten	703, 704, 706-708, 1110-1112
KIRSCHNER Bauchdeckenhalter	472, 473	L	
KIRSCHNER Extensionsbügel	1154, 1155	LA FORCE Tonsillotome	630
KIRSCHNER Führungshohlsonden	510, 511	LA GRANGE Zahnfleischschere	124
Klammeranlagezangen ETHICON	518	LABORDE Trachealdilatator	654
Klammerinstrumentarium	546, 547	LACK Zungendrücker	601
KLAPP Wundhaken	433	LAHEY Hakenzangen	908
KLEINERT-KUTZ Hohlmeißelzangen	1127, 1132	LAHEY Kropffasszange	657
KLEINERT-KUTZ Sehnendurchziehungen	1152	LAHEY Präparier- und Ligaturklemmen	280, 281
KLEINERT-KUTZ Wundhaken	444	LAHEY Wundhaken	438
KLEINSCHMIDT Darmklemmen	852	LAMBERT-KAY Atraumatische Gefäßklemmen	330
Klemmenhalter	845	LAMBOTTE Knochenhaltezeuge	1124, 1125
Klemmschließzange	845	LAMBOTTE Osteotome	1034
KLIMA-ROSEGGER Sternalpunktionkanüle	73	LAMBOTTE Raspatorien	1065
Klingenbrecher	47	LAMBOTTE Wundhaken	378
Klingenhalter	47	Laminektomie-Spreizer	564-567, 586-591
KLINKENBERGH-LOTH Gefäßscheren	131	Laminektomie-Stanzen	958-978, 984, 985
KNAPP Wundhaken	432	Laminektomie-Stanzen, zerlegbar	962, 966
KNIGHT Nasenscheren	121	Laminektomie-Wundsperrer	556-559
KNIGHT Septumzangen	696	Laminektomie-Zangen	979-983, 985-987, 994-1007
KNIGHTON Wirbelkörperspreizer	593	LANDAU Scheidenspekulas	893
Knöchelfasszangen	1117	LANDAU Trokare	71
Knochen- und Gelenkspreizer	1184	LANDOLT Eukleatoren	706
Knochenformzange	1118	LANDOLT Häkchen	706
Knochenhalteklammern	1126	LANDOLT Kürette	706
Knochenhaltezeuge	1117-1125	LANDOLT Laminektomie-Zangen	1005
Knochenhebel	1075-1083	LANDOLT Löffel	706
Knochensplitterzangen	1141-1144	LANDOLT Nasenscheren	121
Knopfsonden	62, 827, 828	LANDOLT Raspatorien	562
Knorpelmesser	53, 54	LANDOLT Skalpellgriffe	826
Knorpelquetsche	686	LANDOLT Spreizzange für Spekulas	702
Knorpelritzmesser	672	LANDOLT-REULEN Dissektoren	708
Knorpelscheren	115, 116	LANDOLT-REULEN Kürette	708
KNOWLES Verbandsscheren	1186	LANDOLT-REULEN Raspatorium	708
Koagulations Saugrohre	87	LANDON Scheidenspekulas	892
KOCHER Arterienklemmen	254, 255	LANE Chirurgische Pinzetten	215
KOCHER Blasenspatel	953	LANE Darmklemmen	853
KOCHER Darmklemmen	846, 848	LANE Knochenhebel	1076
KOCHER Kropffonden	657	LANE Tuckklemmen	368
KOCHER Unterbindungsnadeln	502	LANE-TRETHOWAN Knochenhebel	1076
KOCHER Wundhaken	376, 392, 399, 404	LANGE Broncho-Oesophagoskopiezangen	637
KOCHER-LANGENBECK Wundhaken	389, 390	LANGE Verbandsscheren	1186
KOCHER-WAGNER Wundhaken	405	LANGE Wundhaken	436
KOELNER Kopfhautklammern	546	LANGE-HOHMANN Knochenhebel	1079, 1080
KOENIG Elevatorien	1052	LANGENBECK Amputations- und Resektionssägen	1010
KOENIG Führungshohlsonden	512	LANGENBECK Amputationsmesser	52
KOENIG Raspatorien	1053	LANGENBECK Elevatorien	1074
KOENIG Stimmgabeln	714	LANGENBECK Fingerschutz	619
KOENIG Wundhaken	437	LANGENBECK Knochenhaltezeuge	1118
KOERTE Wundhaken	379, 424	LANGENBECK Ohrschlingen	728
KOGAN Endospekulas	896	LANGENBECK Raspatorien	1064

LANGENBECK Resektionsmesser	53	LOVE Gaumensegelhalter	627
LANGENBECK TC Nadelhalter	531	LOVE Nervwurzelhaken	551, 552, 553
LANGENBECK Wundhaken	381-383	LOVE-GRUENWALD Laminektomie-Zangen	996
LANGENBECK-RYDER TC Nadelhalter	534	LOVELACE Lungenfaßzangen	801
LANGE-WILDE Ohrpolypenschnürer	738	LOWER Präparier- und Ligaturklammern	281
LANGE-WILDE Polypenschnürer	671	LOWMAN Knochenhalteklammern	1126
LANG-STEVENSON Darmklammern	852	LOWMAN-HOGLUND Knochenhalteklammern	1126
Lanzettenmesser	747, 752, 837	LUBET-BARBON Tampon- und Polypenzangen	669
Lappenmesser	745	LUC Septumzangen	697
Lärmtrommeln	716	LUCAE Hämmer	1016
Laryngealschnürer	652	LUCAE Ohr- und Nasenpinzetten	221, 222
Laryngologie	652, 653	LUCAE Parazentesenadeln	737
Laryngoskope Batteriegriffe	42-43	LUCAE Stimmgabeln	713, 714
Laryngoskope mit Kaltlicht und Zubehör	40-41, 43	LUCAE Wundhaken	429
Laryngoskope und Zubehör	36-43	LUCAS Scharfe Löffel	1091
LAWRENCE Präparier- und Ligaturklammern	264	LUER Darm- und Gewebefaßzangen	366
Leberblindpunktionskanülen	74	LUER Hohlmeißelzangen	1128, 1130
LEBSCHKE Einführungsinstrumente	549	LUER Spritzen	74
LEBSCHKE Sternmeißel	764	LUER Tracheal-Kanülen	654
LEES Atraumatische Gefäßklammern	314, 323	LUER Wundhaken	419
LEGUEU Blasenpatel	953	LUER-FRIEDMANN Hohlmeißelzangen	1127
LEGUEU Blasenwundspreizer	952	LUER-KOERTE Gallensteinlöffel	873
LEKSELL Hohlmeißelzangen	1137	LUER-LOCK Spritzen	74, 76
LEKSELL-STILLE Hohlmeißelzangen	1137	LUER-STILLE Hohlmeißelzangen	1138, 1139
LELAND-JONES Atraumatische Gefäßklammern	317-319	Luftbläser	75
LEMPERT Elevatoren	737	Luftduschen	716, 717
LEMPERT Raspatorien	1054	LUIKART-BILL Zangenschloß	936
LEMPERT Saugrohre	80	LUKENS Trachealhäkchen	656
LEMPERT Scharfe Löffel	1098	Lumbales Mikrodiskotomie Retraktor Set	583
LERCHE Chirurgische Pinzetten	218	Lungenfasspinzetten	216
LERICHE Arterienklammern	247, 257	Lungenfaßzangen	801
LERICHE Wundhaken	423	Lungenspatel	800, 801
LEWIN Repositionszangen	1116	LUNIATSCHEK Tamponstopfer	626
LEWIS Nasenraspeln	1084	Lupusküretten	60
LEWKOWITZ Steinzangen	945	Lupusschaber	60
LEXER Flachmeißel	1042	LURZ Gallensteinzangen	877
LEXER Hohlmeißel	1043, 1044, 1048	Luxationshebel	1083
LEXER Osteotome	1043, 1047	M	
LEXER Präparierscheren	112, 155	M.G. HOSPITAL Nadelhalter	489
LEXER SCT Präparierscheren	188	Magenklammern	851
LEXER Spongiosa Hohlmeißel	1045, 1048	MAGILL Katheter-Einführungszangen	944
LEXER TC Präparierscheren	171	MAGILL Saugrohre	79
LEXER-BABY Präparierscheren	112	Magnetstab	822
LEXER-MINI Hohlmeißel	1041	MAINGOTT Hysterektomieklammern	275
LEXER-MINI Osteotome	1041	MALTZ Nasenraspeln	1085, 1087
LEYLA Retraktoren zur Fixation am Schädel	540-542	Mamillenringe	21
LICHTENBERG Nadelhalter	497	Mammoplastik Wundhaken	422
LICHTENBERG TC Nadelhalter	530	Mammaria Sperrer	794-797
LICHTWITZ Kieferhöhlenpunktionskanüle	87	MANNERFELT Hohlmeißel	1181
LICHTWITZ Kieferhöhlenretrokarie	70, 87	MANNERFELT Osteotome	1181
Ligatur-Gummiringe	866	MANNERFELT Raspatorien	1180, 1181
Ligaturinstrumente	627	MANNERFELT Wundhaken	1178-1180
Ligaturscheren	146, 147	MARKWALDER Hohlmeißelzangen	1139
Lippen- und Wangenhalter	618	MARQUARDT Hohlmeißelzangen	1133
LISTER Dilatationsbougies	950	MARSCHIK Tonsillenfasszangen	620
LISTER Sinusklammern	352	MARSCHIK-KRONE Tonsillenfasszangen	621
LISTER Verband- und Gipscheren	1190	MARTIN Abfallzangen	1218
LISTER Verbandscheren	1187	MARTIN Beckenzirkel	931
LISTON Amputationsmesser	52	MARTIN Fingerringssägen	1011
LISTON Knochensplitterzangen	1141-1143	MARTIN Gipsmesser	1195
LISTON-KEY Knochensplitterzangen	1144	MARTIN Knorpelscheren	116
LISTON-STILLE Knochensplitterzangen	1143	MARTIN Kornzangen	351
LITTAUER Cilienpinzetten	223	MARTIN Meniskus- und Knorpelfaßzangen	1146
LITTAUER Ligaturscheren	147	MARTIN Uterussonden	899
LITTAUER Ohrpolypenzangen	732	MARTIN Watteträger	65
LITTAUER Tampon- und Polypenzangen	670	MARTIN Wundhaken	375, 377, 414
LITTLE Wundhaken	438	MARTIN-CUSHING Raspatorien	1071
LITTLER Feine chirurgische Scheren	126	MARTINI Scharfe Löffel	1091
LITTLER Ligaturscheren	147	MARTIN-LANGENBECK Raspatorien	1071
LITTLEWOOD Darm- und Gewebefaßzangen	365	MASING Knorpelritzmesser	672
LLOYD-DAVIES Rektumscheren	106	MASING Nasenhaken	690
LLOYD-DAVIES Rektum-Anastomoseklammern	856	MASING Ohrzängchen	734
LOCKHART-MUMMERY Sonden	64	MASING Septumlevatorien	677
LOCKLIN Gefäßscheren	133	Maßbänder	21
LOCKLIN TC Zahnfleissscheren	178	MASSON Nadelhalter	493
LOCKWOOD Darm- und Gewebefaßzangen	362	MASSON TC Nadelhalter	527
LOCKWOOD-ALLIS Darm- und Gewebefaßzangen	365	MASSON-LUETHY Nadelhalter	494
Löffel	706, 707, 831, 832, 840, 841	Mastdarmspekulas	861, 862
LOPEZ-REINKE Tonsillendissektoren	622	MASTIN Muskelklemme	657
LORENZ Verband- und Gipscheren	1190	MATHIEU Analspreizer	861
LORNA (EDNA) Tuckklammern	369	MATHIEU Fremdkörperzangen	948
Lösungsschalen	1212	MATHIEU Nadelhalter	496
LOUTE Cerclage-Instrumente	1158	MATHIEU Scheidenspekulas	892



MATHIEU TC Nadelhalter	528, 529	MICK Verband- und Gipsscheren	1188, 1189
MATHIEU Wundhaken	418	MICRO-ADSON Arterienklemmen	245
MATHIEU-RYDER TC Nadelhalter	534	MICRO-MOSQUITO Arterienklemmen	250, 259
MATZENAUER Scheidenspekulas	892	MICRO-RYDER TC Nadelhalter	532
MAUNDER Mundkeile	619	MICRO-VASCULAR TC Nadelhalter	532
MAXIMUS Blutdruckmessgeräte	24	MIDDELDORPF Wundhaken	400
MAYFIELD Hohlmeißelzangen	1132	MIDDLETON-JANSEN Septumzangen	699
MAYO Chirurgische Scheren	103, 152	Mikro Dissektoren	814
MAYO Chirurgische SCT Scheren	186	Mikro-Drahtbiegezüngchen	741, 742, 744
MAYO Chirurgische TC Scheren	165	Mikro-Faßzangen	642-643, 646, 649-651
MAYO Gallensteinlöffel	874	Mikro-Häkchen	749
MAYO Sterilisierklammern	372	Mikro-Instrumente	745-753, 827-841
MAYO TC Ligaturscheren	181	Mikro-Löffelzüngchen	739, 743
MAYO Zungenspatel	600	Mikro-Löffelzangen	642, 647-651
MAYO-ADAMS Wundspreizer, selbsthaltend	449	Mikro-Messer	745
MAYO-BLAKE Gallensteinzangen	877	Mikro-Nadelhalter	643, 644
MAYO-GUYON Nierenstielklemmen	285	Mikro-Nadeln	748, 749, 752, 753
MAYO-HARRINGTON Chirurgische Scheren	105, 153	Mikro-Ohrscherchen	740, 744
MAYO-HARRINGTON Chirurgische SCT Scheren	186	Mikro-Ohrzüngchen	739, 743
MAYO-HARRINGTON Chirurgische TC Scheren	165	Mikro-Pinzetten	226-228
MAYO-HEGAR Nadelhalter	488, 489	Mikro-Scheren	138-143, 644, 646, 651
MAYO-HEGAR TC Nadelhalter	521	MIKULICZ Peritoneumklemmen	277-279
MAYO-LEXER TC Präparierscheren	171	MIKULICZ Wundhaken	392, 393
MAYO-NOBLE Chirurgische Scheren	105	MILAN Biopsieküretten	914
MAYO-ROBSON Darmklemmen	850	MILIGAN Wundspreizer, selbsthaltend	449
MAYO-RUSSIAN Gewebefasspinzetten	203	MILLARD (COTTLE) Fingerringhäkchen	689
MAYO-STILLE Chirurgische Scheren	104, 153	MILLER Laryngoskope	37
MAYO-STILLE Chirurgische SCT Scheren	187	MILLER Laryngoskope mit Kaltlicht	41
MAYO-STILLE Chirurgische TC Scheren	167	MILLER Nasenraspeln	1087
MC CLINTOCK Plazenta- und Abortuszangen	940	MILLER Scharfe Löffel	1092
MC CLURE Mikro-Scheren	138	MILLER-COLBURN Nasenraspeln	1088
MC CULLOCH Laminektomie-Spreizer	586, 587	MILLER-COLBURN Scharfe Löffel	1094
MC DONALD Raspatorien	1055	MILLIGAN Dura-Dissektoren	550
MC GEE Häkchen	750	MILLIN Blasenhalsspreizer	953
MC GEE Mikro-Drahtbiegezüngchen	741, 744	MILLIN Blasenwundspreizer	952
MC GIVNEY Hämorrhoidal-Ligatoren	868	MILLIN Kapsel-faßzangen	955
MC GLAMRY Raspatorien	1068	MILLS Gefäßscheren	137
MC INDOE Anatomische Pinzetten	199	MINI-HOHMANN Knochenhebel	1075
MC INDOE Anatomische TC Pinzetten	232	MINI-LAMBOTTE Osteotome	1030, 1031
MC INDOE Chirurgische Pinzetten	211	MINI-LANGENBECK Wundhaken	439
MC INDOE Knorpelscheren	115	MINIMUS Blutdruckmessgeräte	24
MC INDOE Osteotome	684	MINI-OLSEN Nadelhalter mit Schere	495
MC INDOE Wundhaken	443	MINI-ROUX Wundhaken	417
MC INTOSH Laryngoskope	38	MINI-TOWNSEND Uterus-Biopsiezangen	922
MC INTOSH Laryngoskope mit Kaltlicht	40	Mini-Transformator	27
MC IVOR Mundsperrerr	614	MINI-VANNAS Mikro-Scheren	138
MC IVOR Zungendrucker	616	MISKIOM Wundspreizer, selbsthaltend	454
MC KENTY Septumelevatorien	676, 677	MIXTER Chirurgische Scheren	97
MC KENZIE Klammerzangen	547	MIXTER Gallensteinzangen	878
MC KENZIE Silberklammern	546	MIXTER Präparier- und Ligaturklemmen	268, 280
MC KENZIE Silberklammernblock	546	MIXTER-O'SHAUGNESSY Präparier- und Ligaturklemmen	281
MC KESSON Mundkeile	619	MKG Wundhaken	1057
MC QUIGG-MIXTER Atraumatische Gefäßklemmen	300	MOCK Heparinnadeln	73
MEAD Hämmer	1013	MOELTGEN Winkelmesser	20
MEAD Hohlmeißelzangen	1130	MOLDENHAUER Ohrhebel	730
Meatotom	948	MOLDESTAD Wundhaken	433
Medizinbecher	1213, 1214	MOLLISON Wundspreizer, selbsthaltend	447
Medizinlöffel	1213	MOLT Mundsperrerr	603
MEEKER Präparier- und Ligaturklemmen	266	MOLT Raspatorien	1054
MEMORY Hirnspatel	544	MOORE Gallenblasenlöffel	873
MENGHINI Leberblindpunktionskanülen	74	MOORE Handbohrapparate	1171
Meniskus- und Knorpelfaßzangen	1145, 1146	MOORFIELD Nahtpinzetten	198
Meniskusmesser	1146, 1147	MORGAN Proktoskope	864
MERCEDES Rippensperrerr	790	MORITZ-SCHMIDT Zungendrucker	601
Messbecher	1213	MORRIS Wundhaken	401
Messschieber	559	MORRIS-DE BAKEY Atraumatische Gefäßklemmen	324
Messstäbe	22	MORSE Rippensperrerr	775, 778, 779
Messzirkel	20, 22	MORSE-FAVALORO Rippensperrerr	778
Metallkatheter	951	MOSHER-BRUENINGS Intubationsrohr	653
METZENBAUM Nadelhalter	489	MOSQUITO-DANDY Arterienklemmen	248
METZENBAUM Präparierscheren	108-111, 154	MOYNIHAN Gallensteinsonden	872
METZENBAUM SCT Präparierscheren	187, 188	MOYNIHAN Hysterektomieklammern	273
METZENBAUM TC Ligaturscheren	181	MUCK Periotmesser	735
METZENBAUM TC Präparierscheren	167-170	MUEHLING Raspatorien	562
METZENBAUM-BABY Präparierscheren	111, 155	MUELLER Rektum-Anastomoseklammern	858
METZENBAUM-LAHEY TC Präparierscheren	173	MUELLER Wundspreizer, selbsthaltend	445
MEYER Repositionszangen	1116	MUENCHEN Biopsieküretten	913
MEYERDING Wundhaken	407, 441, 489	Mukosamesser	673
MEYERDING Wundspreizer, selbsthaltend	452	Mundkeile	619
MICHEL Rhinoskopiepiegel	632	Mundsperrerr	603-614
MICHEL Wundklammern	516	MURPHY Stirnband	35
MICHEL Wundklammerpinzetten	517	MURPHY-LANE Luxationshebel	1083
MICHEL Wundklammerzangen	517	MUSEUX Hakenzangen	905, 906, 908



MUSGROVE Zerummennadel und Watteträger	730	OBWEGESER Unterbindungsadeln	501
Muskelklemmen	657	OBWEGESER Weichteilhaken	384, 385
MYLES Nasenzangen	990	OBWEGESER Weisheitszahnhaken	387
Myomheber	908	OCHSNER Anatomische Pinzetten	203
Myommesser	56	OCHSNER Atraumatische Gefäßklemmen	331
Myringotom	735	OCHSNER Gallenblasentrom	71
Myrtenblattsonden	62	OCHSNER Gallensteinsonden	873
N		OCHSNER-KOCHER Arterienklemmen	252, 253
NABATOFF Krampfaderbesteck	806	O'CONNOR Wundhaken	431
Nabelschnurklemmen	937	Ohr- und Nasenpinzetten	221, 222
Nabelschnurscheren	102	Ohrhäkchen	730, 731
Nadeln	841	Ohrhebel	730
Nadel Dosen	1222, 1223	Ohrkatheter	716
Nadelhalter	488-499	Ohrküretten	728-730
Nadelhalter mit Hartmetalleinlagen	520-535	Ohr Lupen	726, 727
Nadelhalter mit Schere	495	Ohrpolypenschnürer	738
Nadel-Sterilisationsgestelle	1223	Ohrpolypenzangen	732
NAEGELE Geburtszangen	932	Ohrsclingen	728-730
Nagelbohrer	1207	Ohrspekulas	720-726
Nagelfeilen	1206	Ohrspritzen	719
Nagelscheren	1204	Ohrzängchen	732-734
Nagelzangen	1205, 1206	OKONEK-YASARGIL Tumorgabeln	828
NAGER Gaumensegelhalter	627	OLDBERG Laminektomie-Zangen	1005
Naht Lineale	823	OLIVECRONA Drahtsägen	1010
Nahtpinzetten	198	OLIVECRONA Dura-Dissektoren	550
Nasenflügelhäkchen	688, 689	OLIVECRONA Hirnspatel	544
Nasenfraktur Elevatorien	698	OLIVECRONA Hohlmeißelzangen	1131
Nasenhaken	687-690	OLIVECRONA Nasenscheren	120
Nasenplastikmesser	672	OLIVECRONA Trigeminiussmesser	57
Nasenrachenzangen	631	OLIVECRONA-TOENNIS Klammerzangen	547
Nasenraspeln	1084-1090	OLLIER Wundhaken	380
Nasensägen	685	OLSEN-HEGAR Nadelhalter mit Schere	495
Nasenscheren	118-122, 156, 754	OLSEN-HEGAR TC Nadelhalter	527
Nasenspekulas	660-668	OMBREDANNE Hämmer	1015
Nasenzangen	756-760, 988-994	Operationslaryngoskope	638-641
NEFF Meniskusmesser	1146	Organfasszangen	358
NEGUS (GUEDEL) Laryngoskope	36	Organmesser	55
NEGUS Bruststütze für alle Mundsperrler	617	O'SHAUGNESSY Präparier- und Ligaturklemmen	281
NEGUS Nierenstielklemmen	282	Osteotome	680-684, 1021, 1026-1051
NEGUS Ringmesser	629	O'SULLIVAN-O'CONNOR Scheidenspekulas	895
NEIVERT Nadelhalter	491	O'SULLIVAN-O'CONNOR Bauchdeckenhalter	476
NEIVERT Nasenflügelhäkchen	690	Oszillierende elektrische Autopsiesägen	1022, 1023
NEIVERT-ANDERSON Osteotome	683	Oszillierende elektrische Gips sägen	1196-1199
NEIVERT-MASING TC Nadelhalter	524	OTIS Urethrotom	954
NÉLATON Hohlsonden	63	Otoskope	599, 712
NELSON Lungenfasspinzetten	216	OVERHOLT Präparier- und Ligaturklemmen	261, 262
NELSON Trokare	69	OVERHOLT-GEISSENDOERFER Präparier- und Ligaturklemmen	260
Neonatal-Gefäßklemmen	298-299	OVERHOLT-MIXTER Präparier- und Ligaturklemmen	268
Nerv- und Gefäßhaken	822, 829	P	
Nervwurzelhaken	551-553	PACHON Blutdruckmessgeräte	24
NEW ORLEANS TC Nadelhalter	526	PAPAVERO-CASPAR Spekulas für Hypophysektomie	702
NEWS Trachealhäkchen	656	Parazentesenadeln	735-737
NICOLA Kürette	704	PARKER Wundhaken	417
NICOLA Mikro-Löffelzange	651	PARKER-BABY Wundhaken	417
NICOLA Mikro-Schere	651	PARKER-KERR Rektum-Anastomoseklemmen	855
NICOLA Raspatorium	704	PARKER-LANGENBECK Wundhaken	418
NIEDERDELLMANN Osteotome	1038	PARKER-MOTT Wundhaken	418
Nierenfistelzangen	874, 876	PARKS Nasenraspeln	1087
Nierenschalen	1212	PARTSCH Flachmeißel	1027
Nierensteinzangen	875	PARTSCH Hämmer	1017
Nierenstielklemmen	282-284	PARTSCH Hohlmeißel	1028
NISSSEN Arterienklemmen	243	PARTSCH-LANGE Raspatorien	1052
NORFOLK & NORWICH Wundspreizer, selbsthaltend	453	PASSOW Stößel	1024
Notfallkoffer	28	Patellazangen	1117
NOTO Polypen und Ovarienzangen	357	PAUL Wundhaken	444
NOTT Scheidenspekulas	883	PAYR Darmklemmen	854
NOVAK Biopsieküretten	912	PAYR Führungshohlsonden	512
NOYES Mikro-Scheren	140	PEAN Arterienklemmen	238-241
NUBOER Saugrohre	78	PECK-JOSEPH Feine chirurgische Scheren	123
NUSSBAUM Darmklemmen	849	PEDERSON Scheidenspekulas	883, 884
O		PEERS-BERTRAM Tuchklemmen	369
O'BRIEN Feine chirurgische Scheren	128	PEET Splitterzangen	1208
OBWEGESER Blattosteotome	1035	PELMANN Kornzangen	355
OBWEGESER Elevatorien	1056	PELTESON Watteträger	633
OBWEGESER Interdentale Osteotome	1036	PENFIELD Duradissectoren	812
OBWEGESER Keilosteotome	1035	Penisklemmen	946
OBWEGESER Kinnhalter	383, 1057	PENNINGTON Darm- und Gewebefasszangen	362
OBWEGESER Osteotome	1035, 1036	PENNINGTON Septumelevatorien	676
OBWEGESER Progenierinnen	1057	PENNYBACKER Hohlmeißelzangen	1131
OBWEGESER Ramushaken	386	PENNYBACKER Laminektomie-Zangen	1004
OBWEGESER Raspatorien	1058, 1059	PENNYBAKER Duradissectoren	813
OBWEGESER Raspeln	1088	PERCY Amputationsretraktoren	1008
OBWEGESER Spaltungsosteotome	1035	Perforatorien	748, 937



Periostmesser	735	RALK Handbohrapparate	1172, 1173
Peritoneumklappen	277-279	RALK Splitterzangen	1208
PERKINS Wundspreizer, selbsthaltend	448	RAMPLEY Schwammzangen	359
Perkussionshämmer	16, 17	Ramushaken	386
PERTHES Reibahlen	1012	RANDALL Biopsieküretten	912
PESTALLOZZA Plazenta- und Abortuslöffel	942	RANDALL Nierenfistelzangen	876
Petrischalen	1214	RANDALL Nierensteinzangen	875
PETZ Darm- und Magenklappen	860	RANEY Klammerzangen	546
Pflasterspatel	66	RANEY Kopfhautklammern	546
Phalangenmesser	52	Rasierklingen	47, 1207
PHANEUF Hysterektomieklappen	273	Rasierklingen-Brecher und -Halter	825
Phlebodissektor	814	Rasiermesser	58
Phleboextraktor	814	Raspatorien 562, 563, 704, 708, 752, 831, 832, 835, 1052-1055, 1058-1071	1088, 1089
PIERCE Kieferhöhlentroker	70	Raspeln	1088, 1089
PIERCE Septumelevatorien	676	RAY Kürette	703
PINARD Foetal-Stethoskope	17	RECAMIER Uterusküretten	925, 926, 928
Pinzetten	194-229	REDON Führungsadeln	66-68
Pinzetten mit Hartmetalleinsätzen	232-236	Reflexspiegel	35
PIPER Geburtszangen	934	Reibahlen	1012
PITHA Kornzangen	352	REICHERT Kehlkopfdeckelhalter	633
PITHA Mundkeil	619	REILL Drahtkneifzangen	1164
Plazenta- und Abortuslöffel	942	REILL Repositionszangen	1116
Plazenta- und Abortuszangen	939-941	REINER Gipsmesser	1195
PLESTER Antrumhäkchen	747, 748	Reinigungsbürste	1227
PLESTER Exkavator	747	Rektum-Anastomoseklappen	855-859
PLESTER Führungsgabel	747	Rektum-Biopsiezangen	869
PLESTER Häkchen	747	Rektumschere	106, 107
PLESTER Lappenmesser	745	Repositionszangen	1115
PLESTER Saugrohre	77	RESANO Kapselschere	105
PLESTER Schaber	748	RESANO Rektum-Anastomoseklappen	859
PLESTER Sichelmesser	745	Resektionsmesser	53, 54
PLESTER Wundspreizer, selbsthaltend	448	Retraktoren zur Fixation am Schädel	540-542
POLITZER Furunkelmesser	735	REVERDIN Bauch- und Darmspatel	421
POLITZER Luftduschen	716, 717	REVERDIN Unterbindungsnadeln	500
POLITZER Ohrspekulas	721	REYNOLDS Präparierschere	114, 156
POLITZER Parazentesenadeln	736	REYNOLDS SCT Präparierschere	189
POLLOSON Wundhaken	410	REYNOLDS TC Präparierschere	172, 173
Polypen und Ovarienzangen	356, 357	Rhinoplastik-Messer	672, 673
Polypenschnürer	671	Rhinoskopie Spiegel	632
POOLE Saugrohre	82, 83	RHOTON Dissektor	840
POPLITEA Bauchdeckenhalter	465	RHOTON Elevator	840
POTTS Atraumatische Gefäßklappen	307, 308, 315, 319, 320	RHOTON Häkchen	841
POTTS-DE MARTEL Gefäßschere	136	RHOTON Kugeldissektor	840
POTTS-DE MARTEL SCT Gefäßschere	192	RHOTON Löffel	840, 841
POTTS-SMITH Anatomische Pinzetten	201	RHOTON Nadel	841
POTTS-SMITH Anatomische TC Pinzetten	233	RIBBON-IRIS Feine chirurgische Schere	130
POTTS-SMITH Chirurgische Pinzetten	213	RIBBON-STEVENS Feine chirurgische Schere	130
POTTS-SMITH Gefäßschere	117	RICARD Bauchdeckenhalter	468
POTTS-SMITH Gefäßschere	133, 136, 158	RICHARDSON Wundhaken	412
POTTS-SMITH Gefäßschere	136	RICHARDSON-EASTMAN Wundhaken	411
POTTS-SMITH TC Gefäßschere	179	RICHNAU-HOLMGREN Ohrspekulas	726
POZZI Hakenzangen	902	RICHTER Chirurgische Schere	97
Präparier- und Ligaturklappen	260-270, 280-281	RICHTER-HEATH Wundklammerzangen	518
Präparierschere	108-115, 154-156	RIENHOFF Rippensperr	782
PRATT Analspreizer	861	RIGBY Wundspreizer, selbsthaltend	458
PRATT Hakenzangen	907	RING Zungendrucker	616
PRATT Kieferhöhlenküretten	690	Ringküretten	1111
PRATT Peritoneumklappen	277	Ringmesser	628, 629
PRATT Sonden	64	Ringstripper	808
PRECISA Blutdruckmessgeräte	24	Rippenkontraktoren	800
PRINCE Tonsillenschere	116	Rippenschere	764-768
PRINCE-THOMAS Bronchusklappen	802	Rippensperr	769-799
PRINCE-THOMAS Lungenfaßzangen	801	Rippensperr aus Aluminium	769-776
Progenierinnen	1057	RI-RAP Stethoskope	19
Proktoskope	862, 864	RITTER Stirnhöhlen-Dilatatoren	753
Prostatahaken	953	ROBB Gefäßdissektoren	814
PROVIDENCE-HOSPITAL Arterienklappen	249	ROBERTS Präparier- und Ligaturklappen	269
Prüf und Messinstrumente	20-22	ROBIN MASSE Bauchdeckenhalter	465
Pulverbläser	718	ROBIN Tuchklappen	367
PUTTI Raspeln	1089	ROCHARD Bauchdeckenhalter	477
Q		ROCHESTER-CARMALT Arterienklappen	245
QUATTRO Gipspreizer	1194	ROEDER Ligaturinstrument	627
QUERVAIN Elevatorien	1074	ROEDER Tuchklappen	368
QUINBY Zahnfleischschere	124	ROETTGEN-RUSKIN Hohlmeißelzangen	1134
QUINKE Leberblindpunktkanülen	74	ROGER Septumelevatorien	676
QUIRE Fremdkörperheber	731	ROGERS Hysterektomieklappen	275, 276
R		ROGGE Sterilisierzangen	1209
RABINER Perkussionshammer	17	ROLLET Wundhaken	432
Rack für Rhoton Instrumente	839	Rollmesser	746
RADOLF Nagelzangen	1206	ROSCHKE Analspreizer	864
RAGNELL Wundhaken	419	ROSE Wundhaken	419
RAGNELL-DAVIS Wundhaken	440	ROSEN Fenestrierhäkchen	747
RAKE Wundhaken	486	ROSEN Lanzettenmesser	747

ROSEN Löffel	747	Schleimhautmesser	745
ROSEN Mikro-Nadel	748, 749	SCHLESINGER Laminektomie-Zangen	1006
ROSEN Raspatorium	747	Schließklemmen	860
ROSEN Rundschnittmesser	746	SCHMEDEEN Nasenzangen	992
ROSEN Saugrohre	85	SCHMID Gefäß Spülkanülen	73
ROSER-KOENIG Mundsperrler	604	SCHMID Intimaspatel	813
ROSS Aortahaken	816	SCHMIEDEN Führungshohlsonden	511
ROUX Wundhaken	416	SCHMIEDEN Unterbindungsnadeln	502
ROUX-MAGNUS Wundhaken	417	SCHMIEDEN-DICK Unterbindungsnadeln	501
RUBIN Osteotome	681	SCHMIEDEN-PAYR Führungshohlsonden	511
RUBIN Septumzangen	701	SCHMIEDEN-TAYLOR Gefäßscheren	133
RUDD Hämorrhoidal-Ligatoren	867	SCHNEIDER Raspatorien	1064
RUMEL Präparier- und Ligaturklemmen	267	SCHNEIDER-SAUERBRUCH Raspatorien	1065
RUMEL-BELMONT Fadenfänger	815	SCHNIDT Arterienklemmen	244
RUMEL-BELMONT Krampfaderinstrumente	815	SCHNIDT Tonsillenfasszangen	620
Runde Schalen	1212, 1214	Schnüdröhre	624, 652, 671, 738
Rundkopfstanzten	756	SCHOEMAKER Darmklemmen	852
Rundschnittmesser	746, 752, 753	SCHOEMAKER-LOTH Ligaturscheren	147
RUSKIN Hohlmeißelzangen	1133	SCHOENBORN Trachealhäkchen	656
RUSKIN Kieferhöhlentroker	87	SCHROEDER Fistelmesser	56
RUSKIN-LISTON Knochensplitterzangen	1142	SCHROEDER Hakenzangen	901, 903, 907
RUSSEL-DAVIS Zungendrücker	615	SCHROEDER Uteruslöffel	924
RUSSIAN Gewebefasspinzetten	203	SCHUBERT Uterus-Biopsiezangen	916, 917
RUST Amputations- und Resektionssägen	1009	SCHUHKNECHT Biegegerät zum Formen von Drahtprothesen	686
RYDEL-SEIFFER Stimmgabeln	713	SCHUHKNECHT Saugrohre	89
RYDER Nadelhalter	498	SCHUKNECHT Mikro-Drahtbiegezängchen	741
RYDER-VASCULAR TC Nadelhalter	532	SCHUKNECHT Rollmesser	746
S		SCHUKNECHT Sichelmesser	746
SAALFELD Komedoneninstrument	61	SCHUL Diskektomie-Spreizer	594
SACHS Dura-Dissektoren	550, 551	SCHULTZE Salpingograph	915
SACHS Durahaken	554	SCHUMACHER Broncho-Oesophagoskopiezangen	637
SACHSE Meatotom	948	SCHUMACHER Nabelschnurschere	102
SAENGER Plazenta- und Abortuszangen	941	SCHUMACHER Rippenscheren	764
SALENIUS Meniskusmesser	1146	SCHUMACHER Uterus-Biopsiezangen	920
Salpingograph	915	SCHUMACHER-VAN DOREN Uterus-Biopsiezangen	918
SALYER Face-lift Scheren	118	Schwammzangen	359
SAMII Lanzettenmesser	837	SCHWEDEEN Scharfe Löffel	1091
SAMII Tumormesser	836, 837	Schwestern garnitur	1207
SANTULLI Bulldogklemmen	296	Schwingmesser	679
SANVENERO Feine chirurgische Scheren	124	SCOVILLE Laminektomie-Wundsperrler	558
SAROT Nadelhalter	490	SCOVILLE Nervwurzelhaken	552
SAROT Präparier- und Ligaturklemmen	267	SCOVILLE Scharfe Löffel	1106
SAROT TC Nadelhalter	524	SCOVILLE Seitenvulven	557, 558
SATINSKY Atraumatische Gefäßklemmen	332	SCOVILLE Wundhaken	486
SATINSKY Gefäßscheren	131	SCOVILLE-HAVERFIELD Laminektomie-Wundsperrler	557
SATINSKY Vena-Cava-Klemmen	347, 348	SCOVILLE-RICHTER Laminektomie-Wundsperrler	556
SATTERLEE Amputations- und Resektionssägen	1010	SCOVILLE-RICHTER Seitenvulven	565
SAUERBRUCH Abfallzangen	1218	SCT Gefäßscheren	191
SAUERBRUCH Nadeldosen	1223	SCT Nasenscheren	189, 190
SAUERBRUCH Rippenscheren	765	SCT Präparierscheren	187
SAUERBRUCH Wundhaken	382, 394	SCT Uterusscheren	186
SAUERBRUCH-CORYLLOS Hohlmeißelzangen	1140	SCUDDER Magenklemmen	851
SAUERBRUCH-FREY Rippenscheren	767	SEBILEAU Elevatorien	1074
Saug- und Spülinstrumente	86-89	SEDILLOT Raspatorien	1063
Saugelevatorien	674, 678	SEDILLOT Raspatorien	1065
Saughandgriffe	85	SEEMANN-SEIFERT Mundsperrler	605
Saugrohre	77-89	SEGOND Myommesser	56
SAUNDERS Instrument für die Entfernung von Spiralen	911	SEGOND-LANDAU Hysterektomieklammern	273
SAWTELL Tonsillenfasszangen	620	Sehndurchziehungen	1150-1152
SCALP-CONTOUR Wundspreizer, selbsthaltend	446	Sehnenflechtklammern	1150-1152
Schaber	748	Sehnenführer	1153
Schädelhalter	548	Sehnenmesser	745
Schädelspalter	1021	Sehnenmesser	745
Schädelszangen	549	Sehnenmesser	1152, 1153
SCHAEDEL Tuchklemmen	368	SEIDL Scheidenspekulas	887
SCHAMBERG Komedoneninstrument	61	SEIFFERT Broncho-Oesophagoskopiezangen	637
Scharfe Löffel	751	Sekretlöffel	911
Scharfe Löffel	1091-1114	SELDIN Raspatorien	1064
Scharfes Häkchen	830	SELLHEIM Geburtslöffel	936
SCHEDER Scharfe Löffel	1095	SELLORS Rippenkontraktoren	800
SCHIBE Darm- und Gewebefasszangen	362	SELMANN Fasspinzette	204
Scheidenspekulas	880-895	SELVERSTONE Laminektomie-Zangen	998, 999
SCH EINMANN Broncho-Oesophagoskopiezangen	637	SEMB Bronchusklemmen	802
SCHERBACK Scheidenspekulas	894	SEMB Hohlmeißelzangen	1139
Scheren	91-148	SEMB Knochenhaltezeuge	1119
Scheren für die plastische Chirurgie	115	SEMB Knochensplitterzangen	1144
Scheren mit Hartmetallschneiden	160-181	SEMB Raspatorien	1066
SCHIMMELBUSCH Verbandstofftrommeln	1224	SEMKEN Anatomische Pinzetten	199, 200
SCHINDLER Peritoneumklemmen	279	SEMKEN Anatomische TC Pinzetten	232
SCHINK Dermatome	59	SEMKEN Chirurgische Pinzetten	208, 212
SCHINK Spannplatte	59	SEMKEN Chirurgische TC Pinzetten	234, 235
SCHIOETZ Tonometer	23	SEMM Bauchdeckenhalter	474
Schlauchklemmen	370-371	SEMM Scheidenspekulas	882
		SENN-GREEN Wundhaken	438



SENNING TC Nadelhalter	523	SPREADY Laminektomie-Spreizer	589-591
SENN-MILLER Wundhaken	439	Spreizzange für Spekulas	702
Septumelevatoren	674-678	Spritzen	74-76
Septum-Hohlmeißel	679	SPURLING Laminektomie-Zangen	997
Septumkanülen	72	Sputumbecher	1214
Septummesser	672, 673	ST. CLAIR-THOMSON Ringmesser	629
Septumscheren	700	ST. MARKS Wundhaken	420
Septumzangen	696-699, 701	ST. MARKS Analspreizer	866
Sequesterzangen	1118	STACKE Knopfsonden	62
SEUTIN Verband- und Gipsscheren	1191	STANDARD Trokare	69
SEWALL Raspatorien	1052	Standgefäße	1213
SEWALL Raspatorien	1060	Staubinden	29
SEXTON Parazentesenadeln	735	STAUDE-MOORE Hakenzangen	901
SEYFFERT Scheidenspekulas	882	Stechbecken	1215
Seziermesser	54, 55	Steigbügelhäkchen	747
SHAAF Cilienpinzetten	223	STEINBACH Hämmer	1018
SHAMBAUGH Mikro-Häkchen	749	Steinzangen	945
SHAMBOUGH Tonsillotome	630	STELLA Face-lift TC Scheren	175
SHAPLEIGH Ohrschlingen	729	STELLBRINK Hohlmeißelzangen	1127
SHEA Scharfe Löffel	751	STELZNER Rektumscheren	107
SHEEHAN Osteotome	682	Sterilisier- und Lagerungsgestell	1225
Sichelmesser	691, 745, 746, 748, 752	Sterilisierklammern	372
Siebbeinzangen	745	Sterilisierzangen	1209
SIEGLE Ohr lupen	726	Sternalpunktionkanülen	73
Silberklammern	546	STERNBERG Lippen- und Wangenhalter	618
Silberklammernblock	546	Sternnummeißel	764
SILVER Dermatom	59	Stethoskope	17-19
SILVER Osteotome	683	STEVENS Feine chirurgische Scheren	127, 156
SIMON Fistelmesser	56	STEVENS Feine chirurgische SCT Scheren	191
SIMON Scharfe Löffel	1100	STEVENS Irispinzetten	197, 208
SIMON Wundhaken	414	STIEGLITZ Splitterzangen	1208
SIMON Wundhaken	415, 436	Stiellupen	23
SIMPLEX Wangenhalter	619	STILLE Anatomische Pinzetten	197
SIMPSON Geburtszangen	932, 933	STILLE Chirurgische Pinzetten	207
SIMPSON-LUIKART Geburtszangen	934	STILLE Flachmeißel	1032
SIMS Analspreizer	861	STILLE Gallensteinzangen	878
SIMS Mastdarmspekulas	862	STILLE Gipsscheren	1192
SIMS Scheidenspekulas	887	STILLE Handbohrapparate	1171
SIMS SCT Uterusscheren	186	STILLE Hohlmeißel	1033
SIMS TC Uterusscheren	163, 164	STILLE Hohlmeißelzangen	1136
SIMS Uterus-Depressor	900	STILLE Nierenstielklemmen	283, 285
SIMS Uterusküretten	900, 927, 930	STILLE Osteotome	1032
SIMS Uterusscheren	98, 99, 151	STILLE-BARRAYA Gefäß- und Tumorphinzetten	216
SIMS Uterussonden	899	STILLE-RUSKIN Hohlmeißelzangen	1138
SIMS-BODENHAMMER Analspreizer	861	STILLE-SHERMAN Handbohrapparate	1171
SIMS-MAIER Kornzangen	355	Stimmgabeln	713-715
SIMS-SIEBOLD Uterusscheren	100, 152	Stirnband	35
SINGLEY-TUTTLE Gewebefasspinzetten	204	Stirnhöhlen-Dilatatoren	753
Sinusklemmen	352	Stirnhöhlenstanzen	695
Sinuskope	599, 712	Stirnlampen	26-27
Sinuskopie-Instrumente	703-708	STOCKMANN Fixationsklemmen	946
Sinuskopie-Trokare	692	STOCKMANN Penisklemmen	946
Skalpellgriffe	44-47, 50, 823, 825, 826	STONE Chirurgische Pinzetten	218
Skalpellklingen	48, 50	STONE-WATT Darm- und Magenklemmen	860
Skalpellklingen-Entferner	48	STONE-WATT Schließklemme	860
SKENE Hakenzangen	903	Stößel	1024
SLUDER-BALLENGER Tonsillotome	625	STRABISMUS Präparierscheren	112
SMELLIE Dekapitationshaken	937	STRANDELL-STILLE Wundhaken	441
SMELLIE Perforatorien	937	STRASSBURG Chirurgische Pinzetten	212
SMILLIE Meniskussmesser	1147	STRATTE Nadelhalter	492
SMILLIE Wund- und Meniskushaken	1148	STRATTE TC Nadelhalter	526
SMITH TC Drahtscheren	180	STRAUSS Penisklemmen	946
SMITH Verbandscheren	1186	STRONG (COBRA) Atraumatische Gefäßklemmen	318
SMITH-BUIE Analspreizer	864	STRUCK Rippensperrer	782
SMITH-PETERSEN Hohlmeißel	1040	STRUEMPEL Ohrzängchen	734
SMITH-PETERSEN Hohlmeißelzangen	1134	STRULLY Gefäßscheren	131
SMITH-PETERSEN Osteotome	1039	STRUYKEN Nasenzangen	990
SMITHWICK Durahaken	554	SUBRAMANIAN Atraumatische Gefäßklemmen	299
SNELLEN Ohrschlingen	728	SUPERCUT Scheren	150-158
SOMER Uterusfaßzangen	909	SUPERCUT TITAN-NITRIT Scheren	184-192
Sonden	62-64	SWEDISH Dura-Dissektoren	550
Spaltungsosteotome	1035	SWEET Klammerzangen	547
Spannplatte	59	SYPERT Hohlmeißelzangen	1140
Spekula für lumbale Bandscheibenoperationen	585	SYPERT Laminektomie-Stanzen	985
Spekulas für Hypophysektomie	702	SYPERT Laminektomie-Zangen	987
SPENCER-WELLS Arterienklemmen	242	SYSTRUNK Nagelscheren	1204
Spezialkanülen	72-74	T	
Sphinkteroskope	863	TABB Schleimhautmesser	745
Spinal Hohlmeißel	1050	TAKAHASHI Laminektomie-Zangen	994
Splitterpinzetten	224-225	TAKAHASHI Nasenzangen	757
Splitterzangen	1208	Tampon- und Polypenzangen	669, 670
Spongiosa Hohlmeißel	1045	Tamponstopfer	626
SPRATT Scharfe Löffel	1097	Tamponzangen	353

TARNIER Geburtszangen	935	Trokare	69-71
TARNIER Kranioklast	938	TROUSSEAU Trachealdilatator	654
TAYLOR Anatomische Pinzetten	200, 201	TROUTMAN-CHRIS Klingenbrecher	47
TAYLOR Chirurgische Pinzetten	212, 213	TROUTMAN-CHRIS Klingenhalter	47
TAYLOR Perkussionshammer	16	TUBBS Aorta-Dilatatoren	810
TAYLOR Seitenvulven	558	Tuchklemmen	367-369
TAYLOR Wund- und Meniskushaken	1148	TUEBINGEN Gallensteinzangen	878
TAYLOR-BROWN Chirurgische Pinzetten	216	TUEBINGEN Mikropinzetten	227
TC Drahtscheren	180	TUEBINGEN Mikro-Scheren	140
TC Gefäßscheren	179, 180	TUEBINGEN Wundhaken	414
TC Hysterektomiescheren	166	TUEBINGEN Wundspreizer, selbsthaltend	449
TC Ligaturscheren	181	TUFFIER Darm- und Gewebefäßzangen	365
TC Nahtpinzette	236	TUFFIER Rippensperrer	780
TC Nasenscheren	174	TUFFIER Wundhaken	403
TC Präparierscheren	167-173	Tumorgabeln	828
TC Tonsillenscheren	174	Tumormesser	836, 837
TC Uterusscheren	163, 164	Tunneliererset	811
TC Zahnfleischscheren	177, 178	Tupferzangen	349-352, 354, 355
TEALE Hakenzangen	904	TURNBULL Nagelzangen	1205
TERRIER Arterienklemmen	259	TYDING Tonsillenschnürer	624
TESSIER Knochenformzange	1118	TYDING-TIVNEN Tonsillenfasszangen	621
TESSIER Nasenscheren	120	U	
TESSIER Osteotome	1033, 1036, 1037	UCKERMANN Tracheal Trokar	653
TESSIER Raspatorien	1058	UCKERMANN Watteträger	65
THILENIUS Tonsillenabszesszange	623	UFFENORDE Scharfe Löffel	1114
THOMS-ALLIS Darm- und Gewebefäßzangen	364	Uhrmacher Pinzetten	228
THOMS-GAYLOR Uterus-Biopsiezangen	919	ULMER Notfallkoffer	28
THOMSON-WALKER Blasenwundspreizer	952	ULRICH Fistelmesser	56
THOREK Präparierscheren	113	ULRICH Knochenhaltezange	1122
THOREK TC Präparierscheren	171	ULRICH Tupferzangen	349
THUDICHUM Nasenspekulas	660	UNIVERSAL Drahtscheren	148
TIECK-HALLE Nasenspekulas	660, 661	UNIVERSAL Sterilisierzangen	1209
Tiefenmeßsonde	748	UNIVERSAL TC Drahtscheren	180
TILLEY Tampon- und Polypenzangen	669	UNIVERSAL Trokare	69
TILLEY-HENCKEL Nasenzangen	989	UNIVERSAL Verband- und Gipsscheren	1191
TISCHLER Uterus-Biopsiezangen	917	Universalgriff	636, 923
TISCHLER Uterus-Biopsiezangen	921	UNNA Komedoneninstrument	61
TISCHLER-KEVORKIAN Uterus-Biopsiezangen	921	UNNA-VIDAL Komedoneninstrument	61
TISCHLER-MORGAN Uterus-Biopsiezangen	921, 922	Unterbindungsadeln	500-509, 626
TOBOLD Kehlkopfpolypenzangen	634	Unterkieferkörperhaken	1057
TOBOLD Zungendrücker	601	Ureterzangen	945
TOENNIS Arterienklemmen	243, 255	Urethrotom	954
TOENNIS Durahaken	555	Urinale	1216
TOENNIS Duramesser	57, 58	USA Anatomische Pinzetten	196
TOENNIS Intimaspatel	814	USA Chirurgische Pinzetten	206
TOENNIS Nadelhalter	497	USA Gipsspreizer	1194
TOENNIS Präparierscheren	114	USA Nabelschnurschere	102
TOENNIS TC Nadelhalter	531	USA Scharfe Löffel	1108, 1109
TOENNIS-ADSON Präparierscheren	115	Uterus-Kanüle	915
TOENNIS-ADSON SCT Präparierscheren	189	Uterus-Biopsiezangen	916-923
TOENNIS-ADSON TC Präparierscheren	173	Uterus-Depressor	900
TOHOKU Tuchklemmen	369	Uterus-Dilatatoren	897
Tonometer	23	Uterusfaßzangen	909, 910
Tonsillenabszesszange	623	Uterusklemmzange	936
Tonsillendissektoren	622, 623	Uterusküretten	900, 925-930
Tonsillenfasszangen	620	Uteruslöffel	911, 924
Tonsillinkanülen	72	Uterusscheren	98-100, 151, 152
Tonsillennmesser	57, 623	Uterussonden	899
Tonsillennmesser und Enukleator	622	V	
Tonsillennadeln	626	VALLEIX Uterussonden	899
Tonsillenscheren	116, 117	VAN BUREN Dilatationsbougies	950
Tonsillenschnürer	623, 624	VAN BUREN Sequesterzangen	1118
Tonsillotome	625, 630	VAN DOREN Uterus-Biopsiezangen	918, 919
TOWNLEY Messzirkel	22	VANNAS Mikro-Scheren	140
TOYNEE Ohrspekulas	725	VARADY Krampfaderbesteck	807
Tracheal Trokare	653	VARADY Mikro Dissektor	814
Trachealdilatatoren	654	VARADY Phlebo-dissektor	814
Trachealhäkchen	655	VARADY Phleboextraktor	814
Tracheal-Kanülen	654, 655	VASCULAR Nadelhalter	498
Tränenkanalsonden	62, 63	VEDDER Tonsillenschnürer	624
Transformatoren	27, 42-43	VEIDENHEIMER Rektum-Anastomoseklemmen	857
Transplantationsmesser	58	Vena-Cava-Klemmen	347, 348
TRAUBE Perkussionshammer	17	Venenkanülen	72
TRAUTMANN Flachmeißel	1029	Verband- und Gipsscheren	1186-1192
TRAUTMANN Hohlmeißel	1029	Verbandstoffrommeln	1224
TRAVERS Wundspreizer, selbsthaltend	456	VERBRUGGE Knochenhaltezange	1124
TRELAT Raspatorien	1053	VERHOEVEN Saugrohre	89
TRELAT Scheidenspekulas	882	VERRES Insufflationskanüle	73
TREVES Chirurgische Pinzetten	216	VICKERS Bohrhandgriffe	1156
Trigeminusmesser	56, 57	VICKERS Dissektoren	1052
TROELTSCH Ohr- und Nasenpinzetten	221	VICKERS Elevatorien	1052
TROELTSCH-JALASVIRTA Ohr- und Nasenpinzetten	221	VICKERS Finger-Wundspreizer	1183
TROEMMER Perkussionshammer	16	VICKERS Handhalter	1182



VICKERS Wundhaken	428	WIEN Nasenspekulas	662
VICKERS Wundspreizer	1183	WIEN Kieferhöhlenraspeln	693
VIDAL Lupusschaber	60	WIEN MOD. Hysterektomieklappen	274
VIENNA Fadenfänger	513	WIGMORE Gipsmesser	1195
Vigorimeter	21	WIKSTROEM Präparier- und Ligaturklappen	269
VIRCHOW Hirnmesser	55	WILDER Tränenkanalsonden	63
VIRCHOW Schädelspalter	1021	WILLET Kopfschwartzange	936
VIRCHOW Seziermesser	54	WILLET-MARTEL Darm- und Gewebefaßzangen	366
VOLKMANN Scharfe Löffel	1092, 1096, 1104, 1105	WILLIAMS Darm- und Gewebefaßzangen	360
VOLKMANN Wundhaken	374, 378	WILLIAMS Wundspreizer, selbsthaltend	464
VOLLMAR Gefäß Spülkanülen	73	WILLIGER Elevatorien	1074
VOLLMAR Ringstripper	808	WILLIGER Hämmer	1016
VOLTOLINI Nasenspekulas	660	WILLIGER Raspatorien	1053
Vomerzangen	696, 697	WILLIGER Scharfe Löffel	1094, 1096
Vorderrandstripper	1057	WILLIGER Wundhaken	420
Vulvaspreizer	896	WILMER-WALTER Nasenscheren	122
W		WILSON Hakenzangen	904
WACHENFELDT Wundklammerpinzetten	517	Winkelmesser	20
WAGNER Wundhaken	429	WINTER Plazenta- und Abortuszangen	939, 940
WAGNER Biegeinstrumente	1170	Wirbelkörperspreizer	592, 593
WAGNER Feine chirurgische Scheren	125, 126	Wirbelsäulen KIT	482
WAGNER Feine chirurgische TC Scheren	177	WIS-FOREGGER Laryngoskope	39
WAGNER Hämmer	1014	WITTNER Uterus-Biopsiezangen	920
WAGNER Hohlmeißel	1049	WOLFF Gipspreizer	1194
WAGNER Knochenheber	1076, 1080, 1081	WOLFF Lupusküretten	60
WAGNER Laminektomie-Zangen	985, 986	WOODSON Duradisektoren	812
WAGNER Raspatorien	1070	WRIGLEY Geburtszangen	935
WALB Organmesser	55	WUERZBURG Zungendrucker	616
WALDMANN Damm Scheren	101, 152	WULLSTEIN Mikro-Löffelzängchen	739
WALDMANN Damm TC Scheren	162	WULLSTEIN Raspatorien	1054
WALDMANN Episiotomie Scheren	101, 152	WULLSTEIN Saughandgriff	85
WALDMANN Episiotomie TC Scheren	162	WULLSTEIN Saugrohre	77, 86
WALLICH Uteruslöffel	911	WULLSTEIN Wundspreizer, selbsthaltend	447
WALTER Flachmeißel	682	Wund- und Meniskushaken	1148, 1149
WALTER Hohlmeißel	1033	Wundhaken	374-486
WALTER Nasenflügelhäkchen	688	Wundklammern	516
WALTER Osteotome	682	Wundklammerpinzetten	517, 518
WALTON Fingerringssägen	1011	Wundklammerzangen	517, 518
WALTON Rektum-Biopsiezangen	869	Wundspreizer für die cervicale Wirbelsäule	568-581
WALTON-YANKAUER Saugrohre	81	Wundspreizer für die lumbale Wirbelsäule	582-585
Wangenhalter	619	Wundspreizer, selbsthaltend	445-464
WANGENSTEEN Anatomische TC Pinzetten	233	Y	
WANGENSTEEN Gewebefasspinzetten	204	YANKAUER Saugrohre	81, 82
WANGENSTEEN Nadelhalter	494	YASARGIL Dissektor	835
WANGENSTEEN TC Nadelhalter	527	YASARGIL Fadenführer	829
WARTENBERG Algesimeter	20	YASARGIL Galeahaken	545
WARTENBERG Nervrädchen	20	YASARGIL Gefäßmesser	838
Wasserstrahl-Reinigungspistole	1226	YASARGIL Laminektomie-Zangen	1005
WASSMUND Wundhaken	380	YASARGIL Raspatorium	835
WATSON Dermatome	59	YASARGIL Saugrohre	80
WATSON-CHEYNE Dissektoren	1056	YASARGIL-NICOLA Mikro-Faßzange	651
WATSON-JONES Knochenheber	1076	YEOMANN Rektum-Biopsiezangen	869
WATSON-WILLIAMS Nasenzangen	993, 994	YOUNG Prostatahaken	953
Wattespender	1217	YOUNG Zungenzangen	618
Watteträger	65, 66, 633, 653	YOUNG-HRYNTSCHAK Unterbindungsnadeln	513
WAUGH Chirurgische Pinzetten	206	Z	
WEBER Ästhesiometer	20	Zahnfleischscheren	124, 125
WEBER Atraumatische Gefäßklappen	312	ZANDER Reibahlen	1012
WEBER-LOCH Ohrschlingen	729, 730	Zangenschloß	936
WEBSTER Nadelhalter	491	ZAUFAL Ohrhebel	730
WEBSTER TC Nadelhalter	525	ZAUFAL-JANSEN Hohlmeißelzangen	1133
WECKER Mikro-Scheren	139	ZAUFAL-JANSEN Ohrhäkchen	731
Weichteilhaken	384, 385	Zeckenpinzetten	226
WEIL-BLAKESLEY Nasenzangen	988, 989	ZENKER Präparier- und Ligaturklappen	262, 263
WEIL-BLAKESLEY Siebbeinzangen	745	ZENKER Wundhaken	391
Weisheitszahnhaken	387	Zerstäuber	761
WEISMAN Ohrküretten	729	Zerumenlöffel und Häkchen	730
WEISSBARTH Scheidenspekulas	895	Zerumennadel und Watteträger	730
WEITLANER Wundspreizer, selbsthaltend	446, 447, 453, 454	ZIEGLER Cilienpinzetten	223
WEITLANER-BABY Wundspreizer, selbsthaltend	449	ZIEGLER Duramesser	57
WELLER Meniskus- und Knorpelfaßzangen	1145	ZIEGLER Reflexspiegel	35
WERTHEIM Hysterektomieklappen	271, 272	ZIELKE Hohlmeißel	1044
WERTHEIM Rektum-Anastomoseklappen	859	ZOELLNER Führungsgabel	752
WERTHEIM TC Hysterektomiescheren	166	ZOELLNER Häkchen	752
WERTHEIM Uterusscheren	100	ZOELLNER Lanzettenmesser	752
WERTHEIM-CULLEN Hysterektomieklappen	276	ZOELLNER Mikro-Nadel	752
WEST Flachmeißel	1025	ZOELLNER Nasenspekulas	720
WEST Hohlmeißel	1025	ZOELLNER Raspatorium	752
WESTCOTT Mikro-Scheren	141	ZOELLNER Rundschnittmesser	752
WESTMACOTT Tampon- und Polypenzangen	669	ZOELLNER Saugrohre	89
WHITE Tonsillenfaßzangen	620	ZOELLNER Sichelmesser	752
WHITEHEAD Mundsperrer	604	Z-PARAMETRIUM Hysterektomieklappen	286
WIEDER Zungendrucker	602	Zughebel	936

Zungendrucker	601, 602, 615, 616
Zungenspatel	600
Zungenzangen	618
Zwischenknochenmesser	53



A			
Abdominal and intestinal spatulas	421	ASCH Secretion scoop	911
Abdominal retractors	465-477	ASH Septum forceps	698
Abdominal scissors	97, 98	Atomizers	761
ABRAHAM Tonsil grasping forceps	621	Atraumatic vascular clamps	299-346
ABRAHAM Tonsil knife	57	Atrial blade introducer	820
Abscess knife	57	Atrial blades	820
Adenoid curettes	628, 629	Atrial blades holders	820
Adenotomes	630	Atrial Retractor	792, 797, 824
ADLERDYCE Elevators	1055	Atrium retractors	816
ADLERKREUTZ Vascular and tumor forceps	214	AUFRICHT Nasal rasps	1085, 1090
ADSON Bone rongeurs	1131	AUFRICHT Nasal retractors	687
ADSON Dissecting forceps	198, 199	AUFRICHT Plastic surgery scissors	115
ADSON Dissecting TC forceps	232	Aural magnifier	726, 727
ADSON Drill guide forceps	1012	Autopsy knives	54, 55
ADSON Dura hooks	554, 555	AUVARD Vaginal speculas	895
ADSON Haemostatic forceps	245, 256	AYRE Cone knife	56
ADSON Needle holders	489	B	
ADSON Raspatories	1059	BABCOCK Intestinal and tissue grasping forceps	362, 363
ADSON Reamers	1012	BABINSKY Percussion hammer	17
ADSON Suction tubes	78	BABY-ADSON Dissecting and ligature forceps	269
ADSON Tissue forceps	209, 210	BABY-ALLIS Intestinal and tissue grasping forceps	363
ADSON Tissue TC forceps	234	BABY-COLLIN Abdominal retractors	466
ADSON Wound spreaders, self retaining	453, 455, 458-461	BABY-CRILE Haemostatic forceps	248, 257
ADSON-BIEMER-MICRO Tissue forceps	211	BABY-CRILE-WOOD TC Needle holders	523
ADSON-BROWN Tissue forceps	217	BABY-KOCHER Intestinal forceps	844
ADSON-BROWN Tissue TC forceps	235	BABY-MIKULICZ Peritoneum forceps	277
ADSON-DE BAKEY Non-traumatic tissue forceps	218	BABY-MIXTER Dissecting and ligature forceps	270
ADSON-GRAEFE Tissue forceps	217	BABY-MOSQUITO Haemostatic forceps	251
ADSON-MICRO Dissecting forceps	199	BABY-OVERHOLT Dissecting and ligature forceps	270
ADSON-MICRO Dissecting TC forceps	232	BABY-ROUX Retractors	416
ADSON-MICRO Tissue forceps	210, 211	BABY-SATINSKY Vena cava clamps	347
ADSON-MICRO Tissue TC forceps	234	BABY-TISCHLER Cervical biopsy and specimen forceps	921
ADSON-MINI Tissue forceps	210	BABY-YANKAUER Suction tubes	81
Aesthesiometer	20	BACKHAUS Towel clamps	367
AGNEW Tympanum perforator	736	BACKHAUS-KOCHER Towel clamps	367
Air bags	716, 717	BACON Bone rongeurs	1129
Air blower	75	BAGDLEY Laminectomy retractors	559
ALAN-PARKS Rectal retractors	865	BAILEY Laminectomy rongeurs	1007
Alar nasal hooklets	688, 689	BAILEY-GIBBON Rib contractors	800
ALDINGER Bone levers	1081	BAINBRIDGE Atraumatic vascular clamps	314
ALEXANDER Cervical biopsy and specimen forceps	920	BAINBRIDGE Haemostatic forceps	246
ALEXANDER Chisels	1030	BAKES Gall duct dilators	872
ALEXANDER Gouges	1030	BALFOUR Abdominal retractors	470
ALEXANDER Raspatories	1065	BALFOUR Retractors	485
Algesimeter (pinwheel)	20	BALFOUR USA Abdominal retractors	471
Algesimeter with needle and brush	20	BALFOUR-BABY Abdominal retractors	469
ALLEN Intestinal forceps	844	BALL & SOCKET Towel clamps	368
ALLIS Intestinal and tissue grasping forceps	363, 364	BALLENGER Septum gouges	679
ALLIS-ADAIR Intestinal and tissue grasping forceps	365	BALLENGER Swivel knives	679
ALLISON Lung spatulas	800	BALLENGER Tonsil grasping forceps	621
ALM Wound spreaders, self retaining	446	BALLENGER-HAJEK Septum elevators	676
ALY Algesimeter	20	Bandage and plaster-of-paris scissors	1186-1192
Aminoscopes	864	BARANY Noise drum	716
Amniotome	903	BARBARA Micro needle	748, 749
Amputating knives	52	BARNES Suction tubes	88
Amputation and resection saws	1009, 1010	BARNHILL Adenoid curettes	629
Amputation retractors	1008	BARON Suction tubes	88
Anastomosis clamp forceps	845	BARR Rectal retractors	861
ANDERSON-ADSON Wound spreaders, self retaining	453	BARRAQUER Cilia forceps	223
ANESTOPHONE Stethoscope	19	BARRAQUER Micro scissors	140
ANKENEY Rib Spreader	774, 783	BARRON Hemorrhoidal ligators	867
Anterior border stripper	1057	BARSKY Retractors	442
Antrum curettes	690-692	BARTH Bone curettes	1092
Antrum hook	747	BARTH Ear curettes	730
Antrum irrigation cannulas	88	Battery charging device	42
Antrum punches	693-695	BAUMGARTNER Wire forceps	1159
Antrum rasps	693	BAYHA Scalpel handles	44
Antrum scoops	691, 692	BAYONET-KERRISON Laminectomy punches	968-975
Antrum trocars	69, 70, 87	BEACHAM Amniotome	903
Anuscopes	862, 863	BEALE Hook	748
ANVIL Nail nippers	1206	BEALES Tendon knife	745
Aorta dilators	810	BECK Laminectomy rongeurs	994
Aorta punches	811	BECKMANN Adenoid curettes	628
Aorta retractors	816, 817	BECKMANN Nasal speculas	662
Applying forceps for bulldog clamps	293, 296	BECKMANN Wound spreaders, self retaining	459
Areola marker	21	BECKMANN-ADSON Wound spreaders, self retaining	462
ARKANSAS Sharpening stones	58	BECKMANN-EATON Wound spreaders, self retaining	463
Arm systems	478, 479	Bed pans	1215
ARRUGA Needle holders	496	BEEBEE Wire cutting scissors	148
ARRUGA TC Needle holders	531	BEER Cilia forceps	223
Artery forceps	238-260	BEESON Plaster spreaders	1193
Abdominal KIT II	481	BELLUCCI Micro ear scissors	740
		Bending instruments	1170

BENNETT Bone levers	1082	BRAUN Uterine tenaculum forceps	901, 908
BENGOLEA Haemostatic forceps	243, 255	BRAUN Vaginal speculas	892
BENSAUDE Anuscopes	862	BRAUN-STADLER Episiotomy scissors	101
BENSON Intestinal forceps	852	BRAUN-STADLER Perineum scissors	101
BERGER Cervical biopsy and specimen forceps	920	BREISKY Vaginal speculas	894
BERGMANN Bandage and plaster-of-paris scissors	1190	BREISKY WIENER Vaginal speculas	894
BERGMANN Dissecting knives	51	BRIDGE Dissecting and ligature forceps	264
BERGMANN Mallets	1015	BRODIE Directors	64
BERGMANN Plaster saws	1195	BROM Retractors	431
BERGMANN Retractors	434	Broncho-Oesophagoscopy forceps	636
BERLIN Biopsy curettes	913	Bronchoscopy	658, 659
BERLIN Tubing clamps	370	Bronchus clamps	802
BERLINER Percussion hammers	16	BROPHY Dissecting forceps	202
BERNHARD Towel clamps	368	BROPHY Tissue forceps	214
BERTILON Caliper	20	BROWN Needle holders	490
BETHUNE Rib shears	765	BROWN Tissue grasping forceps	217
BEYER Bone rongeurs	1130	BRUENINGS Aural magnifier	727
BEYER Bone rongeurs	1133	BRUENINGS Broncho-Oesophagoscopy forceps	637
BIEMER Vessel spreader	827	BRUENINGS Elongation tubes	636
BILL Traction handle	936	BRUENINGS Septum forceps	697
BILLEAU Ear loops	729	BRUENINGS Septum knife	672
Biopsy curettes	912-914	BRUENINGS Tongue spatulas	600
Biopsy nasal forceps	755	BRUENINGS Tonsil knife	57
BIRCHER Knee retractors	1148	BRUENINGS Tonsil snares	623
BIRCHER Meniscus and cartilage grasping forceps	1145	BRUENINGS-BRUNK Nasal retractors	687
BIRCHER Meniscus knives	1147	BRUENINGS-LUCAS Chisels	1029
BIRCHER-GANSKE Meniscus and cartilage grasping forceps	1145, 1146	BRUENINGS-LUCAS Gouges	1029
BIRKETT Haemostatic forceps	249	BRUNETTI Chisel	1049
Bladder neck spreader	953	BRUNNER Ligature conductors	509, 511
Bladder retractors	952	BRUNNER Ligature needles	502, 509
Bladder spatulas	953	BRUNNER Retractors	396-398, 415
Blade breakers	47	BRUNNER Rib shears	768
Blade holders	47	BRUNNER Sigmoid anastomosis forceps	855
Blade osteotomes	1035	BRUNS Bandage and plaster-of-paris scissors	1190, 1191
BLAKE Gall stone forceps	877	BRUNS Bone curettes	1095, 1106, 1107
BLAKESLEY Septum forceps	757	BRYANT Dressing forceps	352
BLAKESLEY-WIGAND Nasal forceps	991	BUCHWALD Tongue spatulas	600
BLOHMKE Tonsil grasping forceps	621	BUCK Ear curettes	728
Blood collector	29	BUCK Foreign body forceps	731
Blood pressure manometers	24-25	BUCK Ligature scissors	147
BLOUNT Knee retractors	1149	BUCK Myringotome	735
BLUMENTHAL Bone rongeurs	1128	BUCK Percussion hammer	16
BOEHLER Bone cutting forceps	1142	BUCK-GRAMCKO Bone levers	1075
BOEHLER Bone rongeurs	1132	BUECHS Raspatories	1063
BOERMA Obstetrical forceps	934	BUELAU Trocars	70
BOETTCHER Tonsil scissors	116	Bulldog clamps	288-297
BOIES Nasal fracture elevators	698	BUMM Polypus and ovum forceps	356
BONACCOLTO Suture forceps	198	BUMM Uterine curettes	928, 929
Bone and joint spreader	1184	BUNNELL Hand drills	1172
Bone clamps	1126	BUNNELL Tendon stripper	1152, 1153
Bone contouring forceps	1118	BUNT Safety pins	372
Bone curettes	1091-1114	BURFORD Rib Spreader	775-777
Bone cutting forceps	1141-1144	BURKE Cervical biopsy and specimen forceps	920
Bone holding forceps	1117-1125	BUSCH Umbilical cord scissors	102
Bone levers	1075-1083	BUSHE Bone curettes	1113
Bone rongeurs	1126-1140	Buttoned probe	827, 828
Bone wires	1157	C	
BONN Delicate surgical scissors	129	Caesarean section haemostatic forceps	936
BONN Micro forceps	227	CAIRNS Haemostatic forceps	251
BONNEY Dissecting forceps	203	Caliper	20, 22, 559
BONNEY Dissecting TC forceps	233	Callosity Plane	1207
BONNEY Intestinal and tissue grasping forceps	360	CANADIAN Meniscus knives	1147
BONNEY Tissue forceps	215	CAPLAN Septum scissors	700
BONNEY Tissue TC forceps	235	Capsula scissors	105
BOROWSKI Aorta retractors	817	Capsule forceps	955
BOSE Tracheal retractor	655	CARDIOBASE Rib Spreader	798, 799
BOSE Wound spreaders, self retaining	445	CARDIOPHONE Stethoscope	19
BOUCHERON Ear speculas	723	Cardioplegia needle	823
BOWLES Stethoscope	18	CARMALT Splinter forceps	225
BOWMAN Lachrymal probes	62	CAROLL Finger goniometer	20
BOYNTON Needle holders	497	CAROLL Tendon passing forceps	1151
BOYS-ALLIS Intestinal and tissue grasping forceps	365	CARPENTER Tonsil dissectors	622
BOZEMANN Needle holders	493	CARPENTER Tonsil knife and enucleator	622
BOZEMANN TC Needle holders	526	CARREL Haemostatic forceps	251
BOZEMANN Uterine dressing forceps	353	Cartilage crusher	686
BOZEMANN Vascular scissors	131	Cartilage knives	53, 54
BOZEMANN-DOUGLAS Uterine dressing forceps	353	Cartilage scissors	115, 116
Brain knives	55	Cartilage slitting knife	672
Brain spatulas	543, 544	CASPAR Cervical vertebral body distraction system	560, 561
BRAND Tendon passing forceps	1152	CASPAR Bone curettes	1101-1103
BRAUN Cranioclast	938	CASPAR Caliper	559
BRAUN Decapitating Hooks	937	CASPAR Curettes	1110
BRAUN Uterine depressor	900	CASPAR Dissector	832, 833



CASPAR Exploration & coagulation hook	834	COLCLOUGH Laminectomy punches	984
CASPAR Laminectomy retractors	564-567	COLLER Haemostatic forceps	246
CASPAR Laminectomy rongeurs	987, 1000-1004	COLLIER Needle holders	492
CASPAR Laminectomy rongeurs, detachable	1002, 1003	COLLIN Abdominal retractors	466, 467
CASPAR Ligature pusher	828	COLLIN Clip applying forceps	518
CASPAR Nerve root retractors	552	COLLIN Dressing forceps	354
CASPAR Raspatories	562, 563	COLLIN Dynamometer	20
CASPAR Retractors	388	COLLIN Intestinal and tissue grasping forceps	361
CASPAR Retractors for cervical spine	568-579	COLLIN Mallets	1016
CASPAR Retractors for lumbar vertebral column	582, 584	COLLIN Pelvimeter	931
CASPAR Scalpel handles	825	COLLIN Retractors	420
CASPAR Specula for lumbar vertebral operations	585	COLLIN Scalpel handles	47
CASPAR Tampers	1024	COLLIN Toungue holding forceps	618
CASTANEDA Neonatal vascular clamps	298-299	COLLIN Umbilical cord clamp	937
CASTANEDA Rib Spreader	773, 774	COLLIN Uterine grasping forceps	910
CARSTENS Trocars	70	COLLIN Vaginal speculas	880
CASTROVIEJO Blade breakers	47	COLLIN-DUVAL Tissue forceps	204
CASTROVIEJO Blade holders	47	COLLIN-HARTMANN Retractors	416
CASTROVIEJO Lachrymal probes	63	COLLIN-LOKTITE Abdominal retractors	467
CASTROVIEJO Micro forceps	226	COLLYER Pelvimeter	931
CASTROVIEJO Micro scissors	138, 139	Columella forceps	686
Catheter guide	947	Comedone extractor	61
Catheter introducing forceps	944	Compression bandages	29
Catheter introducing instruments	947	Comprimeter	29
CATLIN Amputating knives	52	Conductors for wire saws	549
CAWOOD-MINNESOTA Lip and cheek retractors	618	CONE Cranial rongeur forceps	549
Cerclage instruments	1158	Cone knife	56
Cerumen pick and woolcarier	730	CONE Ring curettes	1111
Cerumen scop and hook	730	CONVERSE Alar nasal hooklets	688
Cervical biopsy and specimen forceps	916-923	CONVERSE Nasal retractors	687
Cervical traction tongs	548	CONVERSE Osteotomes	682
Cervical vertebral body distraction system	560, 561	CONVERSE Rhinoplastic knives	673
CHADWICK Delicate surgical scissors	123	COOLEY Aorta dilators	810
Channel retractors	1057	COOLEY Atraumatic vascular clamps	304, 305, 326, 330, 335-339, 342-345
CHAPUT Intestinal and tissue grasping forceps	366	COOLEY Atrial Retractor	797
CHARNLEY Abdominal retractors	475	COOLEY Atrium retractors	816
CHARRIÈRE Amputation and resection saws	1009	COOLEY Non-traumatic tissue forceps	219, 220
CHEATTLE Sterilising Forceps	1209	COOLEY Rib Spreader	769-771, 788, 789
Cheek retractors	619	COOLEY Suction tubes	83
CHELSEA Proctoscopes	862	COOLEY Vascular dilators	808
CHERON Sponge forceps	354	COOLEY-BECK Atraumatic vascular clamps	340
Chest support	638	COOLEY-LEITZ Atraumatic vascular clamps	340
Chest support for all mouth gags	617	COOPER Ligature needles	502
CHEVALIER Rib Spreader	781	COPE Retractors	440
CHEVALIER-JACKSON Trachea tubes	655	CORDES Broncho-Oesophagoscopy forceps	637
CHILDE Clip applying forceps	517	CORWIN Wire forceps	1160
Chin retractor	383, 1057	CORYLLOS Retractors	395
Chisels	680-682, 751, 1025-1051	CORYLLOS Rib shears	766
CHURCH Vascular scissors	132	COTTLE Alar nasal hooklets	688, 689
Cilia forceps	223	COTTLE Cartilage crusher	686
CINELLI Osteotomes	683	COTTLE Chisels	680, 681
Circular cutting punches	756	COTTLE Columella forceps	686
Circumcision instruments	956	COTTLE Fixation forceps	686
CITELLI Laminectomy punches	958	COTTLE Mallets	1013
CITELLI-BEYER Laminectomy punches	958	COTTLE Nasal rasps	1084
Clamp closing forceps	845	COTTLE Nasal retractors	690
Clamp holder	845	COTTLE Nasal scissors	120, 122
CLAR Head lamps	26	COTTLE Nasal speculas	666-668
CLASSON Vascular scissors	132	COTTLE Osteotomes	680, 1031
CLAUS V. EICKEN Tonsil needle	626	COTTLE Raspatories	1060
Cleaning brush	1227	COTTLE Rhinoplastic knives	673
Cleft palate needles	626	COTTLE Septum elevators	677, 678
CLEVELAND Bone cutting forceps	1141	COTTLE Tonsil TC scissors	174
CLEVELAND Bone rongeurs	1128	COTTLE-KAZANJIAN Bone cutting forceps	1141
Clip applying forceps	517, 518	COTTLE-KNAPP Nasal scissors	122
Clip applying forceps ETHICON	518	COTTLE-MASING Nasal scissors	122
Clip instruments	546, 547	COTTLE-NEIVERT Alar nasal hooklets	689
Closing forceps	860	COTTLE-WALSHAM Septum forceps	698, 699
CLOVER Tonsil grasping forceps	620	Cotton applicators	65, 66, 633, 653
CLOWARD Lamina spreaders	592, 593	Cotton dispenser	1217
CLOWARD Laminectomy rongeurs	1006	COUPLAND Suction tubes	82
CLOWARD Nerve root retractors	553	Cover glass forceps	226
CLOWARD Retractors for cervical spine	580, 581	CRAFOORD Dissecting and ligature forceps	266
Coagulation suction tube	87	CRAFOORD Gynaecological scissors	101
COAKLEY Antrum curettes	690-692	CRAFOORD-SELLORS Dissecting and ligature forceps	266
COAKLEY Antrum trocar	71	CRAIG Septum forceps	696
COBB Curettes	1112	Cranial rongeur forceps	549
COBB Elevators	1072, 1073	Cranioclast	938
COBB Spinal gouge	1050	CREDO Callosity Plane	1207
COBETT Dermatome	59	CRILE Haemostatic forceps	248, 258
COBRA Atraumatic vascular clamps	318	CRILE Needle holders	497
COEN Uterine cannula	915	CRILE Retractors	419, 430
COHEN Raspatories	1055	CRILE-MURRAY Needle holders	490

CRILE-RANKIN Haemostatic forceps	246, 257	DEMEL Wire guides	1158
CRILE-WOOD Needle holders	490	DENHARDT Mouth gags	603
CRILE-WOOD TC Needle holders	522	DENNIS-BROWNE Abdominal retractors	471
CRUTCHFIELD Cervical traction tongs	548	DENNIS-BROWNE Tissue grasping forceps	204
Curettes	703, 704, 706-708, 831, 832, 840, 841, 1110-1112	DERF (WRIGHT) Needle holders	491
CUSCO Vaginal speculas	880-882	DERF TC Needle holders	525
CUSHING Brain spatulas	543	DERF-CONVERSE Needle holders	492
CUSHING Dissecting forceps	202	DERF-CONVERSE TC Needle holders	525
CUSHING Dissecting TC forceps	233	Dermal punch	60, 61
CUSHING Dura hooks	555	Dermatology	60, 61
CUSHING Laminectomy rongeurs	995, 998	Dermatomes	59
CUSHING Retractors	430, 437, 441, 444	DERRA Atraumatic vascular clamps	304
CUSHING Tissue forceps	213	DESCHAMPS Ligature needles	503-508
CUSHING-BROWN Tissue forceps	216	DESJARDINS Gall stone forceps	878
CUSHING-KOCHER Retractors	437	DESJARDINS Gall stone probes	872
CUSHING-LANDOLT Specula for hypophysectomy	702	DESJARDINS Gall stone scoopes	873
CUZZI Placenta and ovum scoops	942	DESJARDINS Kidney pedicle clamps	282
CZERNY Rectal retractors	861	DESMARRES Retractors	436
CZERNY Retractors	420	Diagnostic sets	30-35
CZERNY Uterine tenaculum forceps	906	DICK Hysterectomy Forceps	276
D		DIEFFENBACH Bulldog clamps	292
DAHLGREN Cranial rongeur forceps	549	DIETER Malleus Punches	744
DAHMEN Gouges	1051	DIETRICH Bulldog clamps	291
DAHMEN Osteotomes	1051	DIETRICH Atraumatic vascular clamps	334
DALE Atraumatic vascular clamps	329	DIETRICH-VASCULAR TC Needle holders	532
DANDY Dura hooks	554	Dilating bougies	949, 950
DANDY Haemostatic forceps	249, 258	DINGMANN Bone holding forceps	1117
DANDY Vascular scissors	132	DINGMANN Mouth gags	606
DARDIK Atraumatic vascular clamps	346	DINGMANN Tongue depressors	615
DARLING Wound spreaders, self retaining	452	DIPLOMAT Blood pressure manometers	25
DARTIGUES Uterine grasping forceps	909	Directors	63
DAUBENSPECK Bone curettes	1099	Discectomy retractors	594
DAUTREY-MUNRO Osteotomes	1034	Discision knife	745
DAVIDSON Retractors	411	Dishes	1214
DAVIS Intima spatula	813	Disposable Scalpels	49
DAVIS Sterilising Forceps	1209	Dissecting and ligature forceps	260-270, 280-281
DAVIS-BOYLE Mouth gags	608-612	Dissecting forceps	194-204
DAVIS-BOYLE Tongue depressors	616	Dissecting knives	51
DAVIS-MEYER Mouth gags	607	Dissecting scissors	108-115, 154-156
DAVIS-MEYER Tongue depressors	616	Dissectors	703, 708, 753, 831, 832, 835, 840, 1052, 1056
DAY Ear hooks	731	DITTEL Catheter guide	947
DE BAKEY Atraumatic vascular clamps	300-303, 309-311, 313, 314, 316, 317, 321, 322, 325, 328, 330	DIXON-LOVELACE Haemostatic forceps	247, 257
DE BAKEY Bulldog clamps	288, 289	DOCKHORN Retractors	387
DE BAKEY Dissecting scissors	115	DOUAY Cervical biopsy and specimen forceps	920
DE BAKEY Non-traumatic tissue forceps	219, 220	DOUGHTY Tongue depressors	615
DE BAKEY Non-traumatic tissue TC forceps	236	DOUGLAS Antrum trocar	71
DE BAKEY Rib Spreader	786, 787	DOUGLAS Cilia forceps	223
DE BAKEY Suction tubes	84	DOYEN Abdominal retractors	480
DE BAKEY TC Needle holders	522, 523	DOYEN Abdominal scissors	97, 98
DE BAKEY Vascular dilators	809	DOYEN Directors	63
DE BAKEY Vascular scissors	134, 135	DOYEN Intestinal forceps	844-847
DE BAKEY Vascular TC scissors	179	DOYEN Myoma screws	908
DE BAKEY Wound spreaders, self retaining	464	DOYEN Needle holders	492
DE BAKEY-BAHNSON Atraumatic vascular clamps	310	DOYEN Polypus and ovum forceps	356
DE BAKEY-BECK Atraumatic vascular clamps	305	DOYEN Raspatories	1066, 1067
DE BAKEY-CAROTIS Bulldog clamps	297	DOYEN Retractors	402
DE BAKEY-DIETRICH Bulldog clamps	294	DOYEN Tongue depressors	602
DE BAKEY-MIXTER Atraumatic vascular clamps	300	DOYEN Towel clamps	368
DE BAKEY-MOSQUITO Atraumatic vascular clamps	307	DOYEN Vaginal speculas	893
DE BAKEY-PEAN Atraumatic vascular clamps	306	DOYEN-CHILD Abdominal retractors	480
DE BAKEY-RANKIN Atraumatic vascular clamps	307	DOYEN-COLLIN Mouth gags	603
DE BAKEY-RUMEL Atraumatic vascular clamps	300	DOYEN-JANSEN Mouth gags	603
DE BAKEY-SATINSKY Atraumatic vascular clamps	331	DOYEN-STILLE Retractors	408
DE BAKEY-SATINSKY Bulldog clamps	297	DRAFFIN Holding frame for mouth gags	617
DE LEE Obstetrical forceps	932	Dressing forceps	349-352, 354, 355
DE MARTEL Conductors for wire saws	549	Dressing forceps with tungsten carbide inserts	232-236
DE MARTEL-WOLFSON Anastomosis clamp forceps	845	Drill guide forceps	1012
DE MARTEL-WOLFSON Clamp closing forceps	845	Drill Handles	1156, 1157
DE MARTEL-WOLFSON Clamp holder	845	DUBOIS Decapitating scissors	100
DE VILBISS Cranial rongeur forceps	549	DUEHRSEN Dissecting forceps	203
DEAN Tonsil scissors	116	DUEHRSEN Tissue forceps	215
DEAN Tonsil TC scissors	174	DUKE Trocars	71
DEAVER Retractors	426, 427, 485	DUNN-DAUTREY Osteotomes	1026
DEAVER Surgical scissors	96	DUPLAY Dressing forceps	351, 352
Decapitating Hooks	937	DUPLAY Uterine tenaculum forceps	902
Decapitating scissors	100	DUPLEX Stethoscopes	18
DECKER Laminectomy rongeurs	1006	DUPUY-WEISS Ligature needles	626
DEJERINE Percussion hammers	16	Dura dissectors	812, 813
Delicate surgical scissors	123-130, 156-157	Dura hooks	554, 555
Delicate surgical SCT scissors	190	Dura knives	57, 58, 553
Delicate surgical TC scissors	177, 178	Dura-dissectors	550, 551
DEMEL Cerclage instruments	1158	DURANTE Vascular and tumor forceps	218
		DUVAL Intestinal and tissue grasping forceps	360, 361



DUVAL Tissue forceps	204	FICKLING Dissecting and ligature forceps	269
DUVAL-COLLIN Intestinal and tissue grasping forceps	361	FILIFORM Dilating bougies	949
Dynamometer	20	Finger goniometer	20
E		Finger nail drill	1207
Ear and nasal dressing forceps	221, 222	Finger protector	619
Ear catheters	716	Finger retractor	1183
Ear curettes	728-730	Finger ring saws	1011
Ear forceps	732-734	Finger ring hooks	689
Ear hooks	730, 731	FINOCHIETTO Dissecting and ligature forceps	280
Ear levers	730	FINOCHIETTO Needle holders	494
Ear loops	728-730	FINOCHIETTO Rib Spreader	771-773, 784, 785
Ear polypus forceps	732	FINOCHIETTO TC Needle holders	527
Ear polypus snares	738	FINSEN Wound spreaders, self retaining	445
Ear speculas	720-726	FINSTERER Suction tubes	84
Ear syringes	719	FISCHER Tendon stripper	1153
ECHLIN Bone rongeurs	1135	FISCHER Tonsil knives	623
EDER Cotton applicators	66	Fistula knives	56
EICKEN Antrum irrigation cannulas	88	Fixation clamps	946
EISELSBERG Ligature scissors	147	Fixation forceps	686
EISELSBERG Needle holders	497	Flap knife	745
Elevators	737, 840, 1052-1056, 1072-1074	Flexible naso-pharyngo-laryngofiberscope	598
ELSAESSER Nephrostomy forceps	876	Flexometer	20
Emergency case	28	FOERSTER Sponge forceps	359
EMMET Dressing forceps	354	FOERSTER-BALLENGER Sponge forceps	359
EMMET Retractors	436	FOMON Alar nasal hooklets	688, 689
Empyema trocar	70	FOMON Finger-ring hooks	689
Endolaryngeal micro surgery	642-651	FOMON Nasal rasps	1086, 1090
Endospeculas	896	FOMON Nasal scissors	118, 119, 121
ENGEL Plaster saws	1195	FOMON Nasal SCT scissors	189
Enterotomy scissors	103	FOMON Osteotomes	683
Enucleators	705	FOMON Rhinoplastic knives	672
Epicardial retractors	817	FOMON Tonsil TC scissors	174
Epiglottis retractor	633	Forceps	194-229
Episiotomy scissors	101, 102, 152	FORD-DIXON Hemorrhoidal ligators	868
Episiotomy TC scissors	162	Foreign body forceps	731, 948
EPPENDORF Cervical biopsy and specimen forceps	920, 922	Foreign body instruments	731
ESMARCH Bandage and plaster-of-paris scissors	1190	Foreign body lever	731
ESMARCH Plaster knives	1195	FORMBY Cerumen scoop and hook	730
Ethmoid forceps	745	FOSTER-GILLIES TC Needle holders	528
EVES Tonsil snares	623	FOWLER Tonsil knife	57
EWALD Dissecting forceps	198	FOX Lupus curettes	60
EWALD Tissue forceps	209	FRAENKEL Broncho-Oesophagoscopy forceps	637
Examination and measuring instruments	20-22	FRAENKEL Laryngeal polypus forceps	634, 635
Excavator	747	FRANCKE Blood collector	29
Exploration & coagulation hook	834	FRANZ Abdominal retractors	474
F		FRASER-KELLY Haemostatic forceps	248
Face-lift scissors	117	FRAZIER Dura hooks	555
Face-lift SCT scissors	190	FRAZIER Dura-Dissectors	551
Face-lift TC scissors	175, 176	FRAZIER Suction tubes	77
FAHLBUSCH Curette	707	FRAZIER Ventricel of cerebrum puncture cannulas	80
FAHLBUSCH Micro scissors	651	FREEMAN-GORNEY Face-lift TC scissors	176
FANSLER Anuscopes	862	FREEMAN-KAYE Face-lift TC scissors	176
FARABEUF Bone holding forceps	1120	FREER Chisels	1025
FARABEUF Raspatories	1063	FREER Elevators	1054
FARABEUF Retractors	417	FREER Gouges	1025
FARABEUF-COLLIN Raspatories	1063	FREER Mucosa knife	673
FARABEUF-LAMBOTTE Bone holding forceps	1120	FREER Retractors	443
FARRELL Cotton applicators	65	FREER Septum elevators	674, 675
FARRIOR Ear speculas	720, 724	FREER-GORNEY Suction elevator	674
FAULKNER Antrum curettes	690	FREER-JOSEPH Septum elevators	675
FAURE Cervical biopsy and specimen forceps	916	FREER-YASARGIL Septum elevators	674
FAURE Hysterectomy Forceps	272	FRENZEL Tongue spatulas	600
FAURE Peritoneum forceps	278	FRIEDMANN-JOLL Vulva spreader	896
FAVALORO Vascular scissors	134	FRIEDMANN-MINI Bone rongeurs	1127
FAVALORO Rib Spreader	775	FRIEDMANN-VICKERS Bone rongeurs	1127
FEHLAND Sigmoid anastomosis forceps	856	FRITSCH Retractors	403
FEILCHENFELD Splinter forceps	225	Frontal sinus bougies	753
FEIN Cotton applicators	633	Frontal sinus punches	695
FELDHEIM Tourniquet	1181	FRY Nasal forceps	990
Fenestra hook	747	FRYKHOLM Bone rongeurs	1136
FERGUSON Bone holding forceps	1119	FUCHSIG Haemostatic forceps	247
FERGUSON Gall stone scoopes	874	FULLER Introducing forceps for teflon prothesis	742
FERGUSON Intestinal forceps	853	Furuncle knife	735
FERGUSON Sigmoid anastomosis forceps	855	G	
FERGUSON Suction tubes	78, 79	Galea hooks	545
FERGUSON Surgical scissors	97	Gall bladder scoop	873
FERGUSON-ACKLAND Mouth gags	603	Gall bladder trocar	71
FERRIS-SMITH Tissue forceps	215	Gall duct dilators	872
FERRIS-SMITH Tissue TC forceps	235	Gall stone forceps	877, 878
FERRIS-SMITH-CUSHING Laminectomy rongeurs	979-983	Gall stone probes	872, 873
FERRIS-SMITH-CUSHING Laminectomy rongeurs, detachable	981, 983	Gall stone scoopes	873, 874
FERRIS-SMITH-KERRISON Laminectomy punches	960-967, 978	GALLAHER Nasal rasps	1085
Fetal stethoscopes	17	GARDNER Bone cutting forceps	1141

GARRETT Vascular dilators	809	GUTHRIE Retractors	432
GAST Tongue depressors	615	GUYON Catheter guide	947
GAUSS Scalp flap forceps	936	GUYON Dilating bougies	949
GELFOAM Septum forceps	701	GUYON Kidney pedicle clamps	282-284
GELLHORN Cervical biopsy and specimen forceps	919	GWYNE-EVANS Tonsil dissectors	623
GELPI Retractors	485	Gynaecological scissors	98-102
GELPI-LOKTITE Wound spreaders, self retaining	456, 457	Gynaecological TC scissors	162
GELPI-SEILETZ Wound spreaders, self retaining	457	H	
GEMINI Dissecting and ligature forceps	265	HABERER Abdominal and intestinal spatulas	421
GERALD Dissecting forceps	202	HACKSTOCK Wire forceps	1161
GERALD Dissecting TC forceps	233	Haemostatic forceps	238-260
GERALD Ear and nasal dressing forceps	222	HAGLUND-STILLE Plaster spreaders	1193
GERALD Tissue forceps	214	HAIGHT Rib Spreader	781
GERALD Tissue TC forceps	235	HAJEK Mallets	1013
GERALD-BROWN Tissue forceps	216	HAJEK Nasal forceps	991
GERSTER Traction bar for bone clamps	1126	HAJEK Suction tubes	87
GERZOG Mallets	1017	HAJEK-CLAUS Laminectomy punches	958
GERZOG-SEXTON Tympanum perforator	735	HAJEK-KOFLER Laminectomy punches	959
GIERTZ-STILLE Rib shears	767	HAKANSSON Bone rongeurs	1128
GIGLI T-Bar handle for wire saws	1010	HALLE Bone curettes	1098
GIGLI Wire saws	1010	HALLE Dura knives	553
GILLIES Dissecting forceps	199	HALLE Septum elevators	674
GILLIES Needle holders with scissors	495	HALSEY Needle holders	491
GILLIES Osteotomes	1026	HALSEY TC Needle holders	524
GILLIES Retractors	442	HALSTED-MOSQUITO Haemostatic forceps	244, 250, 256, 258, 259
GILLIES TC Needle holders	528	Hand drills	1171-1173
GILLIES Tissue forceps	211	Hand restrainer	1182
GILLIES Tissue TC forceps	234	HARDY Curette	707
GILLIES-MINI TC Needle holders	528	HARDY Enucleators	705
GILL-VERNET Retractors	438	HARDY Implant fork	705
GLASSMANN Non-traumatic tissue forceps	218	HARDY-FAHLBUSCH Dissectors	703
GLOVER Atraumatic vascular clamps	303, 315, 316	HARGIS Anterior border stripper	1057
GLOVER Bulldog clamps	290, 296	HARGIS Mandibular body retractor	1057
GLUCK Rib shears	764	HARKEN Atraumatic vascular clamps	334
Goitre grasping forceps	657	HARKEN Vena cava clamps	348
Goitre probe	657	HARRINGTON Retractors	409, 485
GOLDMANN Nasal fracture elevators	698	HARRINGTON-PEMBERTON Retractors	409
GOLDMANN-FOX Gum scissors	125	HARTMANN (FRENCH) Tuning forks	713
GOLDMANN-FOX Gum TC scissors	177	HARTMANN Bone rongeurs	1129
GOELET Retractors	418	HARTMANN Cotton applicators	633
GOMEL Micro scissors	143	HARTMANN Ear catheters	716
GOOD Tonsil scissors	117	HARTMANN Ear forceps	732, 733
GOOD-SCHWEKENDIECK Tonsil scissors	117	HARTMANN Ear hooks	731
GORNEY Dissecting scissors	113	HARTMANN Ear polypus forceps	732
GORNEY Face-lift TC scissors	175	HARTMANN Ear speculas	721-723
GORNEY-FREEMAN Face-lift TC scissors	176	HARTMANN Haemostatic forceps	250
GOSSET Abdominal retractors	469	HARTMANN Intestinal forceps	846
GOSSET-BABY Abdominal retractors	469	HARTMANN Nasal forceps	992
Gouges	751, 1025-1051	HARTMANN Nasal speculas	661, 662
GOURDET Uterine curettes	924	HARTMANN Tampon and polypus forceps	669, 670
GRAEFE Delicate surgical scissors	129	HARTMANN Tongue depressors	601
GRAEFE Dissecting knives	51	HARTMANN Tuning forks	713-715
GRAEFE Iris forceps	197, 208	HARTMANN-HALLE Nasal speculas	661
GRAEFE Retractors	429, 431	HARTMANN-HOFFMANN Ear forceps	733
GRAEFE Skin grasping forceps	686	HARTMANN-NOYES Ear forceps	733
GRAEFE Tissue grasping forceps	209	HARTMANN-WEINGAERTNER Ear forceps	733
GRAHAM Dura hooks	554	HARTMANN-WULLSTEIN Ear forceps	732
GRAVE Vaginal speculas	883, 884, 886, 887	HARVEY Wire cutting scissors	148
GRAY Dissecting and ligature forceps	280	HARVEY-JACKSON Wound spreaders, self retaining	463
GREEN-ARMYTAGE Caesarean section haemostatic forceps	936	HASLINGER Velum retractor	627
GREGORY Atraumatic vascular clamps	326	HASOBUCCHI fork	706
GREGORY Face-lift SCT scissors	190	HATFIELD Bone curettes	1112, 1113
GREGORY Face-lift TC scissors	175	HAYES Sigmoid anastomosis forceps	857
GREGORY-SOFT Bulldog clamps	297	Head band	35
GREVEN Micro wire bending forceps	741	Head lamps	26-27
GREY-TURNER Haemostatic forceps	256	HEANEY Hysterectomy Forceps	274
GRONINGEN Dura hooks	554	HEANEY Needle holders	492
GROSS Dressing forceps	350, 351	HEANEY TC Needle holders	526
GROSS Ear loops	730	HEANEY-RAZAK Hysterectomy Forceps	274
GROSS-MAIER Dressing forceps	349, 350	HEANLEY Bone rongeurs	1127
GRUBER Ear speculas	725	HEART-GATE Atrial blade introducer	820
GRUENWALD Atomizers	761	HEART-GATE Atrial blades	820
GRUENWALD Septum forceps	757	HEART-GATE Atrial blades holders	820
GRUENWALD-HENKE Nasal forceps	991	HEART-GATE Atrial Retractor	792, 793
GRUENWALD-JANSEN Ear and nasal dressing forceps	222	HEART-GATE Cardioplegia needle	823
Guide needles	66-68	HEART-GATE Instruments for minimally invasive surgery	818-823
GUILLEN Suction elevators	678	HEART-GATE Ligature catcher	822
GUILFORD-WRIGHT Wire cutting scissors	148	HEART-GATE Ligature ruler	823
GULEKE Bone rongeurs	1131	HEART-GATE Magnet bar	822
Gum scissors	124, 125	HEART-GATE Nerve and vessel hooks	822
Gum TC scissors	177, 178	HEART-GATE Rib Spreader	791, 792
GUNAR-HEY Tubing clamps	371	HEART-GATE Scalpel handle	823
GUSTELLA Osteotomes	684	HEATH Ligature scissors	147



HEATH Mallets	1015	Injection needle	72
HEGAR Needle holders	488	Instrument boxes	1216, 1217
HEGAR TC Needle holders	521	Instrument care lubricant	1227
HEGAR Uterine dilators	897, 898	Instrument for removal of I.U.D.	911
HEGAR-BAUMGARTNER Needle holders	490	Instrument trays	1215, 1216
HEGAR-BAUMGARTNER TC Needle holders	524	Instruments for beating heart surgery	824
HEGAR-VASCULAR TC Needle holders	532	Instruments for minimally invasive surgery	818-823
HEGEMANN-DIETRICH Vascular scissors	137, 158	Insufflation cannula	73
HEGEMANN-DIETRICH Vascular SCT scissors	191	Intestinal and tissue grasping forceps	360-366
HEGEMANN-DIETRICH Vascular TC scissors	180	Interdental osteotomes	1036
HEGENBARTH Clip applying forceps	517	Interosseous knife	53
HEIFETZ Brain spatulas	543	Intestinal and stomach forceps	860
HEIMING Nephrostomy forceps	874	Intestinal forceps	844-854
HEISS Haemostatic forceps	244, 256	Intima spatula	813, 814
HEISTER Mouth gags	603	Introducing forceps for teflon prosthesis	742
HELFFERICH-BIER Amputation and resection saws	1009	Intubation tube	653
HEMINGWAY Bone curettes	1093	IOWA Injection needle	72
Hemorrhoidal ligators	866-868	IOWA Uterine tenaculum forceps	905
HENDERSON Wound spreaders, self retaining	449	IRIS Delicate surgical scissors	127-129, 157
HENKE Tonsil dissectors	622	IRIS Delicate surgical SCT scissors	191
HENLEY Atraumatic vascular clamps	331	IRIS Delicate surgical TC scissors	178
HENLEY Wound spreaders, self retaining	450, 451	Iris forceps	197, 208
HENNIG Plaster spreaders	1193	Irrigators	1215
Heparin flushing needles	73	IRWIN Wound spreaders, self retaining	456
HEPP-SCHIEDL Micro scissors	143	ISRAEL Retractors	380
HERBERHOLD Tongue depressors	616	ITERSON Tracheal retractor	655
HERMANN Chisels	751	IVES-FANSLER Anuscopes	863
HERMANN Gouge	751	J	
HERMANN Mallet	751	JABALEY Delicate surgical scissors	130, 157
HERRICK Kidney pedicle clamps	283	JACKSON Tendon passing forceps	1150
HERTZLER Rib Spreader	780	JACKSON Tracheal retractor	656
HERZ Meniscus and cartilage grasping forceps	1145	JACKSON Vaginal speculas	893
HERZ Tendon passing forceps	1150	JACKSON-BURROWS Wound spreaders, self retaining	457
HESS Bulldog clamps	292	JACOBS Uterine tenaculum forceps	906
HEY-GROVES Bone holding forceps	1123	JACOBSON Bone curettes	1091
HEYMANN Nasal scissors	120, 156	JACOBSON Buttoned probe	827, 828
HEYMANN Nasal SCT scissors	190	JACOBSON Ligature pusher	827, 828
HEYMANN Septum forceps	696	JACOBSON Twin probe	827
HEYMANN-KNIGHT Tampon and polypus forceps	670	JACOBSON Vessel knife	827, 838
HEYWOOD-SMITH Polypus and ovum forceps	357	JAEGER Meniscus and cartilage grasping forceps	1145
HIBBS Chisels	1038	JAEGER Tendon passing forceps	1151
HIBBS Gouges	1039	JAMESON Caliper	22
HIBBS Osteotomes	1038	JAMESON Dissecting scissors	114, 155
HIRSCHMANN Anuscopes	863	JAMESON Needle holders	492
HOEN Dura-Dissectors	551	JAMESON SCT Dissecting scissors	189
HOEN Laminectomy forceps	1007	JAMESON TC Dissecting scissors	172
HOEN Raspatories	1068	JANET Syringes	75, 76
HOEN V. EICKEN Ligature catcher	627	JANSEN Bone curettes	1091, 1092
HOESEL Retractors	408	JANSEN Bone rongeurs	1129, 1130
HOESEL TC Needle holders	530	JANSEN Ear and nasal dressing forceps	222
HOFF Towel clamps	369	JANSEN Ear curettes	730
HOHMANN Bone levers	1077-1079	JANSEN Head lamps	27
HOKE Osteotomes	1037	JANSEN Raspatories	1060, 1064
Holding frame for mouth gags	617	JANSEN Wound spreaders, self retaining	446
HOLINGER Operating laryngoscopes	641	Jars	1213
Holloware	1212-1217	JATHO Naso-pharyngeal forceps	631
HOLSHER Nerve root retractors	553	JAVID Atraumatic vascular clamps	326, 327
HOLZBACH Abdominal retractors	475	JENNINGS Mouth gags	605
HOLZBACH Haemostatic forceps	258	Jeweler forceps	228
HOLZHEIMER Wound spreaders, self retaining	445	JIKEI Septum forceps	759, 760
Hooks	706, 708, 747, 748, 750, 752, 753, 831, 832, 841	JOBSON-HORNE Cotton applicators	65
HOPKINS Plaster knives	1195	JOHN-HOPKINS Applying forceps for bulldog clamps	293
HORSLEY Nerve root retractors	552	JOHN-HOPKINS Bulldog clamps	292, 293
HOUSE Micro needle	748	JOHNS-HOPKINS Dissecting and ligature forceps	281
HOUSE Raspatory	747	JONES Towel clamps	369
HOUSE Sharp curettes	751	JORGENSON Vascular scissors	132
HOUSE Suction tubes	86	JOSEPH Delicate surgical scissors	123
HOUSE Tracheal retractor	656	JOSEPH Delicate surgical SCT scissors	190
HOUSE-DIETER Malleus Punches	742	JOSEPH Delicate surgical TC scissors	177
HOWARTH Septum elevators	678	JOSEPH Nasal rasps	1084
HUBER Universal Handle	636, 923	JOSEPH Nasal saws	685
HUDSON Hand drills	1172	JOSEPH Raspatories	1053
HUGHES Stirrup hook	747	JOSEPH Retractors	443
HUMBY Dermatome	59	JOSEPH Rhinoplastic knives	672, 673
HUNTER Splinter forceps	225	JOSEPH Septum elevators	677
HURD Cleft palate needles	626	JOSEPH Septum knife	673
HURD Tonsil dissectors	622	JOSEPH TC Dissecting scissors	172
HUSFELDT Atraumatic vascular clamps	327	JOSEPH-MASING Septum elevators	677
Hysterectomy Forceps	271-276, 286	JUDD-ALLIS Intestinal and tissue grasping forceps	365
I		JUDD-MASSON Bladder retractors	952
I.M.A. Mammaria Spreader	794-797	JUERS Micro wire bending forceps	742
Implant fork	705	JURASZ Laryngeal polypus forceps	634
INGE Lamina spreaders	592	JURASZ Naso-pharyngeal forceps	631

K			
KABIERSKE Powder blowers	718	KOELNER Scalp haemostatic clips	546
KADER Retractors	425	KOENIG Elevators	1052
KAHN Face-lift scissors	117	KOENIG Ligature conductors	512
KALLMORGEN Vaginal speculas	891	KOENIG Raspatories	1053
KALT Needle holders	497	KOENIG Retractors	437
KANE Umbilical cord clamp	937	KOENIG Tuning forks	714
KANTROWITZ Dissecting and ligature forceps	266	KOERTE Retractors	379, 424
KARLIN-CRANK Laminectomy retractors	588	KOGAN Endospeculas	896
KATSCH Comedone extractor	61	KONRICH Sterilization drums	1224
KATZIN Micro scissors	142	KOOS Vessel knife	838
KATZIN-BARRAQUER Micro scissors	142	KRAEMER Raspatories	1063
KAYE Face-lift scissors	118	KRAEMER Retractors	388
KAYE Face-lift TC scissors	175	KRAUS Vessel knife	838
KAYE-MILLARD Retractors	444	KRAUSE Antrum trocar	71
KELLY Delicate surgical scissors	123, 156	KRAUSE Broncho-Oesophagoscopy forceps	637
KELLY Delicate surgical SCT scissors	190	KRAUSE Ear polypus snares	738
KELLY Delicate surgical TC scissors	177	KRAUSE Polypus snares	671
KELLY Dissecting and ligature forceps	270	KRAUSE-VOSS Ear polypus snares	738
KELLY Haemostatic forceps	249	KRAUSE-VOSS Polypus snares	671
KELLY Polypus and ovum forceps	356	KRAYENBUEHL Nerve and vessel hooks	829
KELLY Retractors	406, 412, 413, 485	KRESSNER Septum forceps	699
KELLY Sphincteroscopes	863	KRISTELLER Vaginal speculas	889-890
KELLY-RANKIN Haemostatic forceps	247	KRISTELLER WIENER Vaginal speculas	891
KELMAN-MC PHERSON Micro forceps	227	KROENLEIN Haemostatic forceps	251
KERN-LANE Bone holding forceps	1119, 1121	KRONECKER Ligature needles	502
KERPEL Bone curettes	1114	KUEHNE Cover glass forceps	226
KERRISON Laminectomy punches	958, 976, 977	KUEMMEL Retractors	401, 424
KERSTING Sigmoid anastomosis forceps	858	KUESTNER Uterine tenaculum forceps	904
KEVORKIAN Biopsy curettes	912	L	
KEVORKIAN Cervical biopsy and specimen forceps	920, 922	LA FORCE Adenotomes	630
KEVORKIAN-PACIFIC Cervical biopsy and specimen forceps	921	LA GRANGE Gum scissors	124
KEY Raspatories	1068	LABORDE Tracheal dilators	654
KEYES Dermal punch	60	Lachrymal probes	62, 63
Kidney Dishes	1212	LACK Tongue depressors	601
Kidney pedicle clamps	282-284	LAHEY Dissecting and ligature forceps	280, 281
Kidney stone forceps	875	LAHEY Goitre grasping forceps	657
KIELLAND Obstetrical forceps	933	LAHEY Retractors	438
KILLIAN Cotton applicators	633	LAHEY Uterine tenaculum forceps	908
KILLIAN Elevators	1055	LAMBERT-KAY Atraumatic vascular clamps	330
KILLIAN Nasal speculas	663-666	LAMBOTTE Bone holding forceps	1124, 1125
KILLIAN Raspatories	1055	LAMBOTTE Osteotomes	1034
KILLIAN Septum elevators	678	LAMBOTTE Raspatories	1065
KILLIAN Septum gouges	679	LAMBOTTE Retractors	378
KILLIAN Septum scissors	700	Lamina spreaders	592, 593
KILLIAN Tampon and polypus forceps	670	Laminectomy punches	958-978, 984, 985
KILLIAN-CLAUS Septum gouges	679	Laminectomy punches, detachable	962, 966
KILLIAN-RUDERT Nasal speculas	665	Laminectomy retractors	556-559, 564-567, 586-591
KILNER (RAGNELL) Dissecting scissors	113, 155	Laminectomy rongeurs	979-983, 985-987, 994-1007
KILNER Alar nasal hooklets	688	Lancet knives	747, 752, 837
KILNER Delicate surgical scissors	126	LANDAU Trocars	71
KILNER Needle holders	491	LANDAU Vaginal speculas	893
KILNER Retractors	419, 439, 442	LANDOLT Curette	706
KILNER TC Dissecting scissors	172	LANDOLT Eucleators	706
KILNER TC Needle holders	525	LANDOLT Hook	706
KILNER-DOUGHTY Mouth gags	613	LANDOLT Laminectomy rongeurs	1005
KIRK Mallets	1017	LANDOLT Nasal scissors	121
KIRKLIN Retractors	438	LANDOLT Raspatories	562
KIRSCH Retractors	388	LANDOLT Scalpel handles	826
KIRSCHNER Abdominal retractors	472, 473	LANDOLT Spreading forceps for speculas	702
KIRSCHNER Ligature conductors	510, 511	LANDOLT-REULEN Curette	708
KIRSCHNER Wire traction bows	1154, 1155	LANDOLT-REULEN Dissectors	708
KLAPP Retractors	433	LANDOLT-REULEN Raspatory	708
KLEINERT-KUTZ Bone rongeurs	1127, 1132	LONDON Vaginal speculas	892
KLEINERT-KUTZ Retractors	444	LANE Bone levers	1076
KLEINERT-KUTZ Tendon passing forceps	1152	LANE Intestinal forceps	853
KLEINSCHMIDT Intestinal forceps	852	LANE Tissue forceps	215
KLIMA-ROSEGGER Sternum puncture needle	73	LANE Towel clamps	368
KLINKENBERGH-LOTH Vascular scissors	131	LANE-TRETHOWAN Bone levers	1076
KNAPP Retractors	432	LANGE Bandage scissors	1186
Knee retractors	1148, 1149	LANGE Broncho-Oesophagoscopy forceps	637
KNIGHT Nasal scissors	121	LANGE Retractors	436
KNIGHT Septum forceps	696	LANGE-HOHMANN Bone levers	1079, 1080
KNIGHTON Lamina spreaders	593	LANGENBECK Amputating knives	52
KNOWLES Bandage scissors	1186	LANGENBECK Amputation and resection saws	1010
KOCHER Bladder spatulas	953	LANGENBECK Bone holding forceps	1118
KOCHER Goitre probe	657	LANGENBECK Ear loops	728
KOCHER Haemostatic forceps	254, 255	LANGENBECK Elevators	1074
KOCHER Intestinal forceps	846, 848	LANGENBECK Finger protector	619
KOCHER Ligature needles	502	LANGENBECK Raspatories	1064
KOCHER Retractors	376, 392, 399, 404	LANGENBECK Resection knives	53
KOCHER-LANGENBECK Retractors	389, 390	LANGENBECK Retractors	381-383
KOCHER-WAGNER Retractors	405	LANGENBECK TC Needle holders	531
		LANGENBECK-RYDER TC Needle holders	534



LANGE-WILDE Ear polypus snares	738	LOUTE Cerclage instruments	1158
LANGE-WILDE Polypus snares	671	LOVE Nerve root retractors	551, 552, 553
LANG-STEVENSON Intestinal forceps	852	LOVE Velum retractor	627
Laryngeal mirrors	632	LOVE-GRUENWALD Laminectomy rongeurs	996
Laryngeal polypus forceps	634, 635	LOVELACE Lung grasping forceps	801
Laryngeal snare	652	LOWER Dissecting and ligature forceps	281
Laryngeal Syringe	76	LOWMAN Bone clamps	1126
Laryngology	652, 653	LOWMAN-HOGLUND Bone clamps	1126
Laryngoscopes and accessories	36-43	LUBET-BARBON Tampon and polypus forceps	669
Laryngoscopes battery handle	42-43	LUC Septum forceps	697
Laryngoscopes with cold light and accessories	40-41, 43	LUCAE Ear and nasal dressing forceps	221, 222
LAWRENCE Dissecting and ligature forceps	264	LUCAE Mallets	1016
Lead hands	1182	LUCAE Retractors	429
LEBSCHKE Conductors for wire saws	549	LUCAE Tuning forks	713, 714
LEBSCHKE Sternum chisel	764	LUCAE Tympanum perforators	737
LEES Atraumatic vascular clamps	314, 323	LUCAS Bone curettes	1091
LEGUEU Bladder retractors	952	LUER Bone rongeurs	1128, 1130
LEGUEU Bladder spatulas	953	LUER Intestinal and tissue grasping forceps	366
LEKSELL Bone rongeurs	1137	LUER Retractors	419
LEKSELL-STILLE Bone rongeurs	1137	LUER Syringes	74
LELAND-JONES Atraumatic vascular clamps	317-319	LUER Trachea tubes	654
LEMPERT Bone curettes	1098	LUER-FRIEDMANN Bone rongeurs	1127
LEMPERT Elevators	737	LUER-KOERTE Gall stone scoopes	873
LEMPERT Raspatories	1054	LUER-LOCK Syringes	74, 76
LEMPERT Suction tubes	80	LUER-STILLE Bone rongeurs	1138, 1139
LERCHE Tissue forceps	218	LUIKART-BILL Traction handel	936
LERICHE Haemostatic forceps	247, 257	LUKENS Tracheal retractor	656
LERICHE Retractors	423	Lung grasping forceps	216, 801
LEWIN Reposition forceps	1116	Lung spatulas	800, 801
LEWIS Nasal rasps	1084	LUNIATSCHEK Tampon plugger	626
LEWKOWITZ Stone forceps	945	Lupus curettes	60
LEXER Chisels	1042	Lupus scraper	60
LEXER Dissecting scissors	112, 155	LURZ Gall stone forceps	877
LEXER Gouges	1043, 1044, 1048	Luxation lever	1083
LEXER Osteotomes	1043, 1047	M	
LEXER SCT Dissecting scissors	188	M.G. HOSPITAL Needle holders	489
LEXER Spongiosa gouges	1045, 1048	MAGILL Catheter introducing forceps	944
LEXER TC Dissecting scissors	171	MAGILL Suction tubes	79
LEXER-BABY Dissecting scissors	112	Magnet bar	822
LEXER-MINI Gouges	1041	Magnifying glasses	23
LEXER-MINI Osteotomes	1041	MAINGOTT Hysterectomy Forceps	275
LEYLA Self-Retaining retractors for skull mounting	540-542	Malleolar forceps	1117
LICHTENBERG Needle holders	497	Mallets	751, 1013-1020
LICHTENBERG TC Needle holders	530	Malleus Punches	742, 744
LICHTWITZ Antrum trocar	70, 87	MALTZ Nasal rasps	1085, 1087
Ligature adjuster	513	Mammoplasty retractors	422
Ligature catchers	513, 627, 815, 822	Mammaria Spreader	794-797
Ligature conductors	509-513	Mandibular body retractor	1057
Ligature guide	829	MANNERFELT Gouges	1181
Ligature instrument	627	MANNERFELT Osteotomes	1181
Ligature needles	500-509, 626	MANNERFELT Raspatories	1180, 1181
Ligature pusher	827, 828	MANNERFELT Retractors	1178-1180
Ligature rings	866	MARKWALDER Bone rongeurs	1139
Ligature ruler	823	MARQUARDT Bone rongeurs	1133
Ligature scissors	146, 147	MARSCHIK Tonsil grasping forceps	620
Lip and cheek retractors	618	MARSCHIK-KRONE Tonsil grasping forceps	621
LISTER Bandage and plaster-of-paris scissors	1190	MARTIN Cartilage scissors	116
LISTER Bandage scissors	1187	MARTIN Cotton applicators	65
LISTER Dilating bougies	950	MARTIN Dressing forceps	351
LISTER Sinus forceps	352	MARTIN Finger ring saws	1011
LISTON Amputating knives	52	MARTIN Meniscus and cartilage grasping forceps	1146
LISTON Bone cutting forceps	1141-1143	MARTIN Pelvimeter	931
LISTON-KEY Bone cutting forceps	1144	MARTIN Plaster knives	1195
LISTON-STILLE Bone cutting forceps	1143	MARTIN Retractors	375, 377, 414
LITTAUER Cilia forceps	223	MARTIN Uterine probes	899
LITTAUER Ear polypus forceps	732	MARTIN Waste forceps	1218
LITTAUER Ligature scissors	147	MARTIN-CUSHING Raspatories	1071
LITTAUER Tampon and polypus forceps	670	MARTINI Bone curettes	1091
LITTLE Retractors	438	MARTIN-LANGENBECK Raspatories	1071
LITTLER Delicate surgical scissors	126	MASING Cartilage slitting knife	672
LITTLER Ligature scissors	147	MASING Ear forceps	734
LITTLEWOOD Intestinal and tissue grasping forceps	365	MASING Nasal retractors	690
Liver blind puncture needles	74	MASING Septum elevators	677
LLOYD-DAVIES Rectal scissors	106	MASSON Needle holders	493
LLOYD-DAVIES Sigmoid anastomosis forceps	856	MASSON TC Needle holders	527
LOCKHART-MUMMERY Probes	64	MASSON-LUETHY Needle holders	494
LOCKLIN Gum TC scissors	178	MASTIN Muscular clamp	657
LOCKLIN Vascular scissors	133	MATHIEU Foreign Body Forceps	948
LOCKWOOD Intestinal and tissue grasping forceps	362	MATHIEU Needle holders	496
LOCKWOOD-ALLIS Intestinal and tissue grasping forceps	365	MATHIEU Rectal retractors	861
LOPEZ-REINKE Tonsil dissectors	622	MATHIEU Retractors	418
LORENZ Bandage and plaster-of-paris scissors	1190	MATHIEU TC Needle holders	528, 529
LORNA (EDNA) Towel clamps	369	MATHIEU Vaginal speculas	892

MATHIEU-RYDER TC Needle holders	534	Micro ear scissors	740, 744
MATZENAUER Vaginal speculas	892	Micro forceps	226-228
MAUNDER Oral screw	619	Micro grasping forceps	642-643, 646, 649-651
MAXIMUS Blood pressure manometers	24	Micro hooks	749
MAYFIELD Bone rongeurs	1132	Micro instruments	745-753, 827-841
MAYO Gall stone scoopes	874	Micro knives	745
MAYO Safety pins	372	Micro lumbar discectomy retractor Set	583
MAYO Surgical scissors	103, 152	Micro needle holder	643, 644
MAYO Surgical SCT scissors	186	Micro needles	748, 749, 752, 753
MAYO Surgical TC scissors	165	Micro scissors	138-143, 644, 646, 651
MAYO TC Ligature scissors	181	Micro wire bending forceps	741, 742, 744
MAYO Tongue spatulas	600	MICRO-ADSON Haemostatic forceps	245
MAYO-ADAMS Wound spreaders, self retaining	449	MICRO-MOSQUITO Haemostatic forceps	250, 259
MAYO-BLAKE Gall stone forceps	877	MICRO-RYDER TC Needle holders	532
MAYO-GUYON Kidney pedicle clamps	285	MICRO-VASCULAR TC Needle holders	532
MAYO-HARRINGTON Surgical scissors	105, 153	MIDDELDORPF Retractors	400
MAYO-HARRINGTON Surgical SCT scissors	186	MIDDLETON-JANSEN Septum forceps	699
MAYO-HARRINGTON Surgical TC scissors	165	MIKULICZ Peritoneum forceps	277-279
MAYO-HEGAR Needle holders	488, 489	MIKULICZ Retractors	392, 393
MAYO-HEGAR TC Needle holders	521	MILAN Biopsy curettes	914
MAYO-LEXER TC Dissecting scissors	171	MILIGAN Wound spreaders, self retaining	449
MAYO-NOBLE Surgical scissors	105	MILLARD (COTTLE) Finger-ring hooks	689
MAYO-ROBSON Intestinal forceps	850	MILLER Bone curettes	1092
MAYO-RUSSIAN Tissue grasping forceps	203	MILLER Laryngoscopes	37
MAYO-STILLE Surgical scissors	104, 153	MILLER Laryngoscopes with cold light	41
MAYO-STILLE Surgical SCT scissors	187	MILLER Nasal rasps	1087
MAYO-STILLE Surgical TC scissors	167	MILLER-COLBURN Bone curettes	1094
MC CLINTOCK Placenta and ovum forceps	940	MILLER-COLBURN Nasal rasps	1088
MC CLURE Micro scissors	138	MILLIGAN Dura-Dissectors	550
MC CULLOCH Laminectomy retractors	586, 587	MILLIN Bladder neck spreader	953
MC DONALD Raspatories	1055	MILLIN Bladder retractors	952
MC GEE Hook	750	MILLIN Capsule forceps	955
MC GEE Micro wire bending forceps	741, 744	MILLS Vascular scissors	137
MC GIVNEY Hemorrhoidal ligators	868	MINI-HOHMANN Bone levers	1075
MC GLAMRY Raspatories	1068	MINI-LAMBOTTE Osteotomes	1030, 1031
MC INDOE Cartilage scissors	115	MINI-LANGENBECK Retractors	439
MC INDOE Dissecting forceps	199	MINIMUS Blood pressure manometers	24
MC INDOE Dissecting TC forceps	232	MINI-OLSEN Needle holders with scissors	495
MC INDOE Osteotomes	684	MINI-ROUX Retractors	417
MC INDOE Retractors	443	MINI-TOWNSEND Cervical biopsy and specimen forceps	922
MC INDOE Tissue forceps	211	Mini-transformer	27
MC INTOSH Laryngoscopes	38	MINI-VANNAS Micro scissors	138
MC INTOSH Laryngoscopes with cold light	40	MISKIOM Wound spreaders, self retaining	454
MC IVOR Mouth gags	614	MIXTER Dissecting and ligature forceps	268, 280
MC IVOR Tongue depressors	616	MIXTER Gall stone forceps	878
MC KENTY Septum elevators	676, 677	MIXTER Surgical scissors	97
MC KENZIE Clip applying forceps	547	MIXTER-O'SHAUGNESSY Dissecting and ligature forceps	281
MC KENZIE Silver brain clips	546	MOCK Heparin flushing needles	73
MC KENZIE Silver clip carrier	546	MOELTGEN Flexometer	20
MC KESSON Oral screw	619	MOLDENHAUER Ear lever	730
MC QUIGG-MIXTER Atraumatic vascular clamps	300	MOLDESTAD Retractors	433
MEAD Bone rongeurs	1130	MOLLISON Wound spreaders, self retaining	447
MEAD Mallets	1013	MOLT Mouth gags	603
Measuring cup	1213	MOLT Raspatories	1054
Measuring rod	748	MOORE Gall bladder scoop	873
Measuring tape	21	MOORE Hand drills	1171
Meatotome	948	MOORFIELD Suture forceps	198
Medicine cup	1213, 1214	MORGAN Proctoscopes	864
Medicine spoon	1213	MORITZ-SCHMIDT Tongue depressors	601
MEEKER Dissecting and ligature forceps	266	MORRIS Retractors	401
MEMORY Brain spatulas	544	MORRIS-DE BAKEY Atraumatic vascular clamps	324
MENGHINI Liver blind puncture needles	74	MORSE Rib Spreader	775, 778, 779
Meniscus and cartilage grasping forceps	1145, 1146	MORSE-FAVALORO Rib Spreader	778
Meniscus knives	1146, 1147	MOSHER-BRUENINGS Intubation tube	653
MERCEDES Rib Spreader	790	MOSQUITO-DANDY Haemostatic forceps	248
Metal Catheters	951	Mouth gags	603-614
METZENBAUM Dissecting scissors	108-111, 154	MOYNIHAN Gall stone probes	872
METZENBAUM Needle holders	489	MOYNIHAN Hysterectomy Forceps	273
METZENBAUM SCT Dissecting scissors	187, 188	MUCK Periosteal Knives	735
METZENBAUM TC Dissecting scissors	167-170	Mucosa knives	673, 745
METZENBAUM TC Ligature scissors	181	MUEHLING Raspatories	562
METZENBAUM-BABY Dissecting scissors	111, 155	MUELLER Sigmoid anastomosis forceps	858
METZENBAUM-LAHEY TC Dissecting scissors	173	MUELLER Wound spreaders, self retaining	445
MEYER Reposition forceps	1116	MUENCHEN Biopsy curettes	913
MEYERDING Retractors	407, 441, 486	MURPHY Head band	35
MEYERDING Wound spreaders, self retaining	452	MURPHY-LANE Luxation lever	1083
MICHEL Clip applying forceps	517	Muscular clamp	657
MICHEL Rhinoscopic mirrors	632	MUSEUX Uterine tenaculum forceps	905, 906, 908
MICHEL Suture Clips	516	MUSGROVE Cerumen pick and woolcarrier	730
MICK Bandage and plaster scissors	1188, 1189	MYLES Nasal forceps	990
Micro cup-shaped forceps	642, 647-651, 739, 743	Myoma knife	56
Micro dissectors	814	Myoma screws	908
Micro ear forceps	739, 743	Myringotome	735



Myrtle leaf probes	62	OLIVECRONA Bone rongeurs	1131
N		OLIVECRONA Brain spatulas	544
NABATOFF Varicose vein probe Set	806	OLIVECRONA Dura-Dissectors	550
NAEGELE Obstetrical forceps	932	OLIVECRONA Nasal scissors	120
NAGER Velum retractor	627	OLIVECRONA Trigeminal knives	57
Nail files	1206	OLIVECRONA Wire saws	1010
Nail nippers	1205, 1206	OLIVECRONA-TOENNIS Clip applying forceps	547
Nail scissors	1204	OLLIER Retractors	380
Nailbrush	1227	OLSEN-HEGAR Needle holders with scissors	495
Nasal forceps	988-994	OLSEN-HEGAR TC Needle holders	527
Nasal fracture elevators	698	OMBREDANNE Mallets	1015
Nasal rasps	1084-1090	OMS retractors	1057
Nasal retractors	687-690	Operating laryngoscopes	638-641
Nasal saws	685	Oral screws	619
Nasal scissors	118-122, 156, 754	Organ grasping forceps	358
Nasal SCT scissors	189, 190	Oscillating electric autopsy saws	1022, 1023
Nasal speculas	660-668	Oscillating electric plaster saws	1196-1199
Nasal TC scissors	174	O'SHAUGNESSY Dissecting and ligature forceps	281
Naso-pharyngeal forceps	631	Osteotomes	680-684, 1021, 1026-1051
Needles	841	O'SULLIVAN - O'CONNOR Vaginal speculas	895
Needle cases	1222, 1223	O'SULLIVAN-O'CONNOR Abdominal retractors	476
Needle holders	488-499	OTIS Urethrotome	954
Needle holders with scissors	495	Otosopes	599, 712
Needle holders with tungsten carbide inserts	520-535	OVERHOLT Dissecting and ligature forceps	261, 262
NEFF Meniscus knives	1146	OVERHOLT-GEISSENDOERFER Dissecting and ligature forceps	260
NEGUS (GUEDEL) Laryngoscopes	36	OVERHOLT-MIXTER Dissecting and ligature forceps	268
NEGUS Adenoid curettes	629	P	
NEGUS Chest support for all moth gags	617	PACHON Blood pressure manometers	24
NEGUS Kidney pedicle clamps	282	PAPAVERO-CASPAR Specula for hypophysectomy	702
NEIVERT Alar nasal hooklets	690	PARKER Retractors	417
NEIVERT Needle holders	491	PARKER-BABY Retractors	417
NEIVERT-ANDERSON Osteotomes	683	PARKER-KERR Sigmoid anastomosis forceps	855
NEIVERT-MASING TC Needle holders	524	PARKER-LANGENBECK Retractors	418
NÉLATON Directors	63	PARKER-MOTT Retractors	418
NELSON Lung grasping forceps	216	PARKS Nasal rasps	1087
NELSON Trocars	69	PARTSCH Chisels	1027
Neonatal vascular clamps	298-299	PARTSCH Gouges	1028
Nephrostomy forceps	874, 876	PARTSCH Mallets	1017
Nerve and vessel hooks	822, 829	PARTSCH-LANGE Raspatories	1052
Nerve root retractors	551-553	PASSOW Tampers	1024
NEW ORLEANS TC Needle holders	526	Patella forceps	1117
NEWS Tracheal retractor	656	PAUL Retractors	444
NICOLA Curette	704	PAYR Intestinal forceps	854
NICOLA Micro cup-shaped forceps	651	PAYR Ligature conductors	512
NICOLA Micro scissors	651	PEAN Haemostatic forceps	238-241
NICOLA Raspatory	704	PECK-JOSEPH Delicate surgical scissors	123
NIEDERDELLMANN Osteotomes	1038	PEDERSON Vaginal speculas	883, 884
NISSEN Haemostatic forceps	243	PEERS-BERTRAM Towel clamps	369
Noise drum	716	PEET Splinter Forceps	1208
Non-traumatic tissue forceps	218-220	PELKMANN Dressing forceps	355
NORFOLK & NORWICH Wound spreaders, self retaining	453	PELTESON Cotton applicators	633
NOTO Polypus and ovum forceps	357	Pelvimeter	931
NOTT Vaginal speculas	883	PENFIELD Dura dissectors	812
NOVAK Biopsy curettes	912	Penis clamps	946
NOYES Micro scissors	140	PENNINGTON Intestinal and tissue grasping forceps	362
NUBOER Suction tubes	78	PENNINGTON Septum elevators	676
NUSSBAUM Intestinal forceps	849	PENNYBACKER Bone rongeurs	1131
O		PENNYBACKER Laminectomy rongeurs	1004
O'BRIEN Delicate surgical scissors	128	PENNYBAKER Dura dissectors	813
Obstetric levers	936	Percussion hammers	16, 17
Obstetrical forceps	932-935	PERCY Amputation retractors	1008
OBWEGESER Blade osteotomes	1035	Perforators	748, 937
OBWEGESER Channel retractors	1057	Perineum scissors	101, 102, 152
OBWEGESER Chin retractor	383, 1057	Perineum TC scissors	162
OBWEGESER Elevators	1056	Periosteal knives	735
OBWEGESER Interdental osteotomes	1036	Periosteum knife	53
OBWEGESER Ligature needles	501	Peritoneum forceps	277-279
OBWEGESER Osteotomes	1035, 1036	PERKINS Wound spreaders, self retaining	448
OBWEGESER Ramus retractors	386	PERTHES Reamers	1012
OBWEGESER Raspatories	1058, 1059	PESTALOZZA Placenta and ovum scoops	942
OBWEGESER Rasps	1088	Petri dish	1214
OBWEGESER Soft tissue retractors	384, 385	PETZ Intestinal and stomach forceps	860
OBWEGESER Splitting osteotomes	1035	Phalangeal knife	52
OBWEGESER Third molar retractor	387	PHANEUF Hysterectomy Forceps	273
OBWEGESER Wedge osteotomes	1035	Phlebextractor	814
OCHSNER Atraumatic vascular clamps	331	Phlebodissector	814
OCHSNER Dissecting forceps	203	PIERCE Antrum trocar	70
OCHSNER Gall bladder trocar	71	PIERCE Septum elevators	676
OCHSNER Gall stone probes	873	PINARD Fetal stethoscopes	17
OCHSNER-KOCHER Haemostatic forceps	252, 253	PIPER Obstetrical forceps	934
O'CONNOR Retractors	431	PITHA Dressing forceps	352
OKONEK-YASARGIL Tumor forks	828	PITHA Oral screw	619
OLDBERG Laminectomy rongeurs	1005	Placenta and ovum forceps	939-941

Placenta and ovum scoops	942	Rectal biopsy forceps	869
Plaster knives	1195	Rectal probes	866
Plaster saws	1195	Rectal retractors	861, 864-866
Plaster spatula	66	Rectal scissors	106, 107
Plaster spreaders	1193, 1194	Rectal speculas	861, 862
Plastic surgery scissors	115	REDON Guide needles	66-68
PLESTER Antrum hook	747, 748	Reflex head mirror	35
PLESTER Excavator	747	REICHERT Epiglottis retractor	633
PLESTER Flap knife	745	REILL Reposition forceps	1116
PLESTER Hook	747	REILL Wire cutting forceps	1164
PLESTER Scraper	748	REINER Plaster knives	1195
PLESTER Sickle knife	745	Reposition forceps	1115
PLESTER Suction tubes	77	RESANO Capsula scissors	105
PLESTER Wire guide	747	RESANO Sigmoid anastomosis forceps	859
PLESTER Wound spreaders, self retaining	448	Resection knives	53, 54
POLITZER Air bags	716, 717	Retractors	374-486
POLITZER Ear speculas	721	Retractors for cervical spine	568-581
POLITZER Furuncle knife	735	Retractors for lumbar vertebral column	582-585
POLITZER Tympanum perforators	736	REVERDIN Abdominal and intestinal spatulas	421
POLLOSON Retractors	410	REVERDIN Ligature needles	500
Polypus and ovum forceps	356, 357	REYNOLDS Dissecting scissors	114, 156
Polypus snares	671	REYNOLDS SCT Dissecting scissors	189
POOLE Suction tubes	82, 83	REYNOLDS TC Dissecting scissors	172, 173
POPLITEA Abdominal retractors	465	Rhinoplastic knives	672, 673
Post mortem knives	55	Rhinoscopic mirrors	632
Post mortem set	1021	RHOTON Curette	840, 841
POTTS Atraumatic vascular clamps	307, 308, 315, 319, 320	RHOTON Dissector	840
POTTS-DE MARTEL Vascular scissors	136	RHOTON Elevator	840
POTTS-DE MARTEL Vascular SCT scissors	192	RHOTON Hook	841
POTTS-SMITH Dissecting forceps	201	RHOTON Needle	841
POTTS-SMITH Dissecting TC forceps	233	RHOTON Teardrop dissector	840
POTTS-SMITH Tissue forceps	213	Rib contractors	800
POTTS-SMITH Vascular scissors	117	Rib shears	764-768
POTTS-SMITH Vascular scissors	133, 136, 158	Rib Spreader	769-799
POTTS-SMITH Vascular scissors	136	Rib Spreader aluminium	769-776
POTTS-SMITH Vascular TC scissors	179	RIBBON-IRIS Delicate surgical scissors	130
Powder blowers	718	RIBBON-STEVENS Delicate surgical scissors	130
POZZI Uterine tenaculum forceps	902	RICARD Abdominal retractors	468
PRATT Antrum curettes	690	RICHARDSON Retractors	412
PRATT Peritoneum forceps	277	RICHARDSON-EASTMAN Retractors	411
PRATT Probes	64	RICHNAU-HOLMGREN Ear speculas	726
PRATT Rectal retractors	861	RICHTER Surgical scissors	97
PRATT Uterine tenaculum forceps	907	RICHTER-HEATH Clip applying forceps	518
PRECISA Blood pressure manometers	24	RIENHOFF Rib Spreader	782
PRINCE Tonsil scissors	116	RIGBY Wound spreaders, self retaining	458
PRINCE-THOMAS Bronchus clamps	802	Ring curettes	1111
PRINCE-THOMAS Lung grasping forceps	801	Ring strippers	808
Probes	62-64	RING Tongue depressors	616
Proctoscopes	862, 864	RI-RAP Stethoscopes	19
Prostatic retractors	953	RITTER Frontal sinus bougies	753
PROVIDENCE-HOSPITAL Haemostatic forceps	249	ROBB Vascular dissectors	814
PUTTI Rasps	1089	ROBERTS Dissecting and ligature forceps	269
Q		ROBIN MASSE Abdominal retractors	465
QUATTRO Plaster spreaders	1194	ROBIN Towel clamps	367
QUERVAIN Elevators	1074	ROCHARD Abdominal retractors	477
QUINBY Gum scissors	124	ROCHESTER-CARMALT Haemostatic forceps	245
QUINKE Liver blind puncture needles	74	ROEDER Ligature instrument	627
QUIRE Foreign body lever	731	ROEDER Towel clamps	368
R		ROETTGEN-RUSKIN Bone rongeurs	1134
RABINER Percussion hammer	17	ROGER Septum elevators	676
Rack for Rhoton instruments	839	ROGERS Hysterectomy Forceps	275, 276
Rack for sterilisation and storage	1225	ROGGE Sterilising Forceps	1209
RADOLF Nail nippers	1206	Roller knife	746
RAGNELL Retractors	419	ROLLET Retractors	432
RAGNELL-DAVIS Retractors	440	ROSCHKE Rectal retractors	864
RAKE Retractors	486	ROSE Retractors	419
RALK Hand drills	1172, 1173	ROSEN Curette	747
RALK Splinter Forceps	1208	ROSEN Fenestra hook	747
RAMPLEY Sponge forceps	359	ROSEN Lancet knife	747
Ramus retractors	386	ROSEN Micro needle	748, 749
RANDALL Biopsy curettes	912	ROSEN Raspatory	747
RANDALL Kidney stone forceps	875	ROSEN Round cutting knives	746
RANDALL Nephrostomy forceps	876	ROSEN Suction tubes	85
RANEY Clip applying forceps	546	ROSER-KOENIG Mouth gags	604
RANEY Scalp haemostatic clips	546	ROSS Aorta retractors	816
Raspatories	562, 563, 704, 708, 752, 831, 832, 835, 1052-1055, 1058-1071	Round Bowls	1212, 1214
Rasps	1088, 1089	Round cutting knives	746, 752, 753
RAY Curette	703	ROUX Retractors	416
Razor blade breaker and holder	825	ROUX-MAGNUS Retractors	417
Razor blades	47, 1207	RUBIN Osteotomes	681
Razor knives	58	RUBIN Septum forceps	701
Reamers	1012	RUDD Hemorrhoidal ligators	867
RECAMIER Uterine curettes	925, 926, 928	Rulers	22



RUMEL Dissecting and ligature forceps	267	SCHULTZE Salpingograph	915
RUMEL-BELMONT Ligature catchers	815	SCHUMACHER Broncho-Oesophagoscopy forceps	637
RUMEL-BELMONT Varicose vein instruments	815	SCHUMACHER Cervical biopsy and specimen forceps	920
RUSKIN Antrum trocar	87	SCHUMACHER Rib shears	764
RUSKIN Bone rongeurs	1133	SCHUMACHER Umbilical cord scissors	102
RUSKIN-LISTON Bone cutting forceps	1142	SCHUMACHER-VAN DOREN Cervical biopsy and specimen forceps	918
RUSSEL-DAVIS Tongue depressors	615	SCHWEDEN Bone curettes	1091
RUSSIAN Tissue grasping forceps	203	Scissors	91-148
RUST Amputation and resection saws	1009	Scissors with tungsten carbide edges	160-181
RYDEL-SEIFFER Tuning forks	713	SCOVILLE Bone curettes	1106
RYDER Needle holders	498	SCOVILLE Laminectomy retractors	558
RYDER-VASCULAR TC Needle holders	532	SCOVILLE Lateral valves	557, 558
S		SCOVILLE Nerve root retractors	552
SAALFELD Comedone extractor	61	SCOVILLE Retractors	486
SACHS Dura hooks	554	SCOVILLE-HAVERFIELD Laminectomy retractors	557
SACHS Dura-Dissectors	550, 551	SCOVILLE-RICHTER Laminectomy retractors	556
SACHSE Meatotome	948	SCOVILLE-RICHTER Lateral valves	565
SAENGER Placenta and ovum forceps	941	Scraper	748
Safety pins	372	SCT Dissecting scissors	187
SALENIUS Meniscus knives	1146	SCUDDER Stomach forceps	851
Salpingograph	915	SEBILÉAU Elevators	1074
SALYER Face-lift scissors	118	Secretion scoop	911
SAMII Lancet knives	837	SEDILLOT Raspatories	1063, 1065
SAMII Tumor knives	836, 837	SEEMANN-SEIFERT Mouth gags	605
SANTULLI Bulldog clamps	296	SEGOND Myoma knife	56
SANVENERO Delicate surgical scissors	124	SEGOND-LANDAU Hysterectomy Forceps	273
SAROT Dissecting and ligature forceps	267	SEIDL Vaginal speculas	887
SAROT Needle holders	490	SEIFFERT Broncho-Oesophagoscopy forceps	637
SAROT TC Needle holders	524	SELDIN Raspatories	1064
SATINSKY Atraumatic vascular clamps	332	Self-Retaining retractors for skull mounting	540-542
SATINSKY Vascular scissors	131	SELLHEIM Obstetric lever	936
SATINSKY Vena cava clamps	347, 348	SELLORS Rib contractors	800
SATTERLEE Amputation and resection saws	1010	SELMANN Tissue forceps	204
SAUERBRUCH Needle cases	1223	SELVERSTONE Laminectomy rongeurs	998, 999
SAUERBRUCH Retractors	382, 394	SEMB Bone cutting forceps	1144
SAUERBRUCH Rib shears	765	SEMB Bone holding forceps	1119
SAUERBRUCH Waste forceps	1218	SEMB Bone rongeurs	1139
SAUERBRUCH-CORYLLOS Bone rongeurs	1140	SEMB Bronchus clamps	802
SAUERBRUCH-FREY Rib shears	767	SEMB Raspatories	1066
SAUNDERS Instrument for removal of I.U.D	911	SEMKEN Dissecting forceps	199, 200
SAWTELL Tonsil grasping forceps	620	SEMKEN Dissecting TC forceps	232
Scalp flap forceps	936	SEMKEN Tissue forceps	208, 212
SCALP-CONTOUR Wound spreaders, self retaining	446	SEMKEN Tissue TC forceps	234, 235
Scalpel blades	48, 50	SEMM Abdominal retractors	474
Scalpel handles	44-47, 50, 823, 825, 826	SEMM Vaginal speculas	882
Scalpel-Blade Remover	48	SENN-GREEN Retractors	438
SCHAEDEL Towel clamps	368	SENNING TC Needle holders	523
SCHAMBERG Comedone extractor	61	SENN-MILLER Retractors	439
SCHÉDE Bone curettes	1095	Septum elevators	674-678
SCHÉIBE Intestinal and tissue grasping forceps	362	Septum forceps	696-699, 701, 756-760
SCHÉINMANN Broncho-Oesophagoscopy forceps	637	Septum gouges	679
SCHERBACK Vaginal speculas	894	Septum knives	672, 673
SCHIMMELBUSCH Sterilization drums	1224	Septum needles	72
SCHINDLER Peritoneum forceps	279	Septum scissors	700
SCHINK Dermatome	59	Sequester forceps	1118
SCHINK Skin fixing plate	59	Set for nurses	1207
SCHIOETZ Tonometer	23	SEUTIN Bandage and plaster-of-paris scissors	1191
SCHLESINGER Laminectomy rongeurs	1006	SEWALL Raspatories	1052, 1060
SCHMEDEN Nasal forceps	992	SEXTON Tympanum perforators	735
SCHMID Intima spatula	813	SEYFFERT Vaginal speculas	882
SCHMID Vessel irrigation cannulas	73	SHAAF Cilia forceps	223
SCHMIEDEN Ligature conductors	511	SHAMBAUGH Micro hooks	749
SCHMIEDEN Ligature needles	502	SHAMBOUGH Adenotomes	630
SCHMIEDEN-DICK Ligature needles	501	SHAPLEIGH Ear loops	729
SCHMIEDEN-PAYR Ligature conductors	511	Sharp curettes	751
SCHMIEDEN-TAYLOR Vascular scissors	133	Sharp Hook	830
SCHNEIDER Raspatories	1064	Sharpening stone	58
SCHNEIDER-SAUERBRUCH Raspatories	1065	SHEA Sharp curettes	751
SCHNIDT Haemostatic forceps	244	SHEEHAN Osteotomes	682
SCHNIDT Tonsil grasping forceps	620	Sickle knives	691, 745, 746, 748, 752
SCHOEMAKER Intestinal forceps	852	SIEGLE Aural magnifier	726
SCHOEMAKER-LOTH Ligature scissors	147	Sigmoid anastomosis forceps	855-859
SCHOENBORN Tracheal retractor	656	Silver brain clips	546
SCHROEDER Fistula knives	56	Silver clip carrier	546
SCHROEDER Uterine curettes	924	SILVER Dermatome	59
SCHROEDER Uterine tenaculum forceps	901, 903, 907	SILVER Osteotomes	683
SCHUBERT Cervical biopsy and specimen forceps	916, 917	SIMON Bone curettes	1100
SCHUHKNÉCHT Die to pre-form wire prothesis	686	SIMON Fistula knives	56
SCHUHKNÉCHT Suction tubes	89	SIMON Retractors	415, 436
SCHUKKNÉCHT Micro wire bending forceps	741	SIMPLEX Cheek retractors	619
SCHUKKNÉCHT Roller knife	746	SIMPSON Obstetrical forceps	932, 933
SCHUKKNÉCHT Sickle knife	746	SIMPSON-LUIKART Obstetrical forceps	934
SCHUL Dissectomy retractors	594	SIMS Rectal retractors	861

SIMS Rectal speculas	862	STILLE Tissue forceps	207
SIMS Uterine curettes	900, 927, 930	STILLE-BARRAYA Vascular and tumor forceps	216
SIMS Uterine depressor	900	STILLE-RUSKIN Bone rongeurs	1138
SIMS Uterine probes	899	STILLE-SHERMAN Hand drills	1171
SIMS Uterine scissors	98, 99, 151	Stirrup hook	747
SIMS Uterine SCT scissors	186	STOCKMANN Fixation clamps	946
SIMS Uterine TC scissors	163, 164	STOCKMANN Penis clamps	946
SIMS Vaginal speculas	887	Stomach forceps	851
SIMS-BODENHAMMER Rectal retractors	861	Stone forceps	945
SIMS-MAIER Dressing forceps	355	STONE Tissue forceps	218
SIMS-SIEBOLD Uterine scissors	100, 152	STONE-WATT Closing forceps	860
SINGLEY-TUTTLE Tissue grasping forceps	204	STONE-WATT Intestinal and stomach forceps	860
Sinus forceps	352	Storing cases	1225
Sinusscopes	599, 712	STRABISMUS Dissecting scissors	112
Sinuscopy instruments	703-708	STRANDELL-STILLE Retractors	441
SKENE Uterine tenaculum forceps	903	STRASSBURG Tissue forceps	212
Skin fixing plate	59	STRATTE Needle holders	492
Skin grasping forceps	686	STRATTE TC Needle holders	526
Skull brakers	1021	STRAUSS Penis clamps	946
SLUDER-BALLENGER Tonsilleotomes	625	STRONG (COBRA) Atraumatic vascular clamps	318
SMELLIE Decapitating Hooks	937	STRUCK Rib Spreader	782
SMELLIE Perforators	937	STRUEMPEL Ear forceps	734
SMILLIE Knee retractors	1148	STRULLY Vascular scissors	131
SMILLIE Meniscus knives	1147	STRUYKEN Nasal forceps	990
SMITH Bandage scissors	1186	SUBRAMANIAN Atraumatic vascular clamps	299
SMITH Wire cutting TC scissors	180	Suction and irrigation instruments	86-89
SMITH-BUIE Rectal retractors	864	Suction curettes	914
SMITH-PETERSEN Bone rongeurs	1134	Suction elevators	674, 678
SMITH-PETERSEN Gouges	1040	Suction handles	85
SMITH-PETERSEN Osteotomes	1039	Suction tubes	77-89
SMITHWICK Dura hooks	554	SUPERCUT scissors	150-158
Snare wires	624, 652, 671, 738	SUPERCUT TITANIUM-NITRITE Scissors	184-192
SNELLEN Ear loops	728	Surgical needles	514-516
Soft tissue retractors	384, 385	Surgical scissors	91-97, 103-105, 151-153
Solution bowls	1212	Surgical SCT scissors	186, 187
SOMER Uterine grasping forceps	909	Surgical TC scissors	162, 165, 167
Special needles	72-74	Suture Clips	516
Specula for hypophysectomy	702	Suture forceps	198
Specula for lumbar vertebral operations	585	Suture needle sterilizing rack	1223
SPENCER-WELLS Haemostatic forceps	242	SWEDISH Dura-Dissectors	550
Sphincteroscopes	863	SWEET Clip applying forceps	547
Spinal KIT	482	Swivel knives	679
Spinal gouges	1050	SYPERT Bone rongeurs	1140
Splinter forceps	224-225	SYPERT Laminectomy punches	985
Splinter Forceps	1208	SYPERT Laminectomy rongeurs	987
Splitting osteotomes	1035	Syringes	74-76
Sponge forceps	349-352, 354, 355, 359	SYSTRUNK Nail scissors	1204
Spongiosa gouges	1045	T	
SPRATT Bone curettes	1097	TABB Mucosa knife	745
Spreading forceps for speculas	702	TAKAHASHI Laminectomy rongeurs	994
SPREADY Laminectomy retractors	589-591	TAKAHASHI Septum forceps	757
SPURLING Laminectomy rongeurs	997	Tampers	1024
Sputum cup	1214	Tampon and polypus forceps	669, 670
ST. CLAIR-THOMSON Adenoid curettes	629	Tampon plugger	626
ST. MARKS Rectal retractors	866	TARNIER Cranioclast	938
ST. MARKS Retractors	420	TARNIER Obstetrical forceps	935
STACKE Probes	62	TAYLOR Dissecting forceps	200, 201
Stainless steel holloware	1212-1217	TAYLOR Knee retractors	1148
STANDARD Trocars	69	TAYLOR Lateral valves	558
STAUDE-MOORE Uterine tenaculum forceps	901	TAYLOR Percussion hammer	16
STEINBACH Mallets	1018	TAYLOR Tissue forceps	212, 213
STELLA Face-lift TC scissors	175	TAYLOR-BROWN Tissue forceps	216
STELLBRINK Bone rongeurs	1127	T-Bar handle for wire saws	1010
STELZNER Rectal scissors	107	TC Dissecting scissors	167-173
Sterilising forceps	1209	TC Hysterectomy scissors	166
Sterilization drums	1224	TC Ligature scissors	181
STERNBERG Lip and cheek retractors	618	TC Suture forceps	236
Sternum chisel	764	TEALE Uterine tenaculum forceps	904
Sternum puncture needle	73	Teardrop dissectors	840
Stethoscopes	17-19	Tendon interlacing forceps	1150-1152
STEVENS Delicate surgical scissors	127, 156	Tendon knife	745
STEVENS Delicate surgical SCT scissors	191	Tendon passing forceps	1150-1152
STEVENS Iris forceps	197, 208	Tendon passing instruments	1153
STIEGLITZ Splinter Forceps	1208	Tendon stripper	1152, 1153
STILLE Bone rongeurs	1136	TERRIER Haemostatic forceps	259
STILLE Chisels	1032	TESSIER Bone contouring forceps	1118
STILLE Dissecting forceps	197	TESSIER Nasal scissors	120
STILLE Gall stone forceps	878	TESSIER Osteotomes	1033, 1036, 1037
STILLE Gouges	1033	TESSIER Raspatories	1058
STILLE Hand drills	1171	THILENIUS Tonsil abscess forceps	623
STILLE Kidney pedicle clamps	283, 285	Third molar retractor	387
STILLE Osteotomes	1032	THOMS-ALLIS Intestinal and tissue grasping forceps	364
STILLE Plaster-of-paris scissors	1192	THOMS-GAYLOR Cervical biopsy and specimen forceps	919



THOMSON-WALKER Bladder retractors	952	Tunneling Set	811
THOREK Dissecting scissors	113	TURNBULL Nail nippers	1205
THOREK TC Dissecting scissors	171	Twin probe	827
THUDICHUM Nasal speculas	660	TYDING Tonsil snares	624
Ticks forceps	226	TYDING-TIVNEN Tonsil grasping forceps	621
TIECK-HALLE Nasal speculas	660, 661	Tympanum perforators	735-737
TILLEY Tampon and polypus forceps	669	U	
TILLEY-HENCKEL Nasal forceps	989	UCKERMANN Cotton applicators	65
TISCHLER Cervical biopsy and specimen forceps	917	UCKERMANN Tracheotomy trocar	653
TISCHLER Cervical biopsy and specimen forceps	921	UFFENORDE Bone curettes	1114
TISCHLER-KEVORKIAN Cervical biopsy and specimen forceps	921	ULM Emergency case	28
TISCHLER-MORGAN Cervical biopsy and specimen forceps	921, 922	ULRICH Bone holding forceps	1122
Tissue forceps	204-218	ULRICH Fistula knives	56
Tissue grasping forceps	203, 204, 209, 217	ULRICH Sponge forceps	349
Tissue Pick	830	Umbilical cord clamp	937
TOBOLD Laryngeal polypus forceps	634	Umbilical cord scissors	102
TOBOLD Tongue depressors	601	UNIVERSAL Bandage and plaster-of-paris scissors	1191
TOENNIS Dissecting scissors	114	Universal Handle	636, 923
TOENNIS Dura hooks	555	UNIVERSAL Sterilising Forceps	1209
TOENNIS Dura knives	57, 58	UNIVERSAL Trocars	69
TOENNIS Haemostatic forceps	243, 255	UNIVERSAL Wire cutting scissors	148
TOENNIS Intima spatula	814	UNIVERSAL Wire cutting TC scissors	180
TOENNIS Needle holders	497	UNNA Comedone extractor	61
TOENNIS TC Needle holders	531	UNNA-VIDAL Comedone extractor	61
TOENNIS-ADSON Dissecting scissors	115	Urethro forceps	945
TOENNIS-ADSON SCT Dissecting scissors	189	Urethrotome	954
TOENNIS-ADSON TC Dissecting scissors	173	Urinals	1216
TOHOKU Towel clamps	369	USA Bone curettes	1108, 1109
Tongue depressors	601, 602, 615, 616	USA Dissecting forceps	196
Tongue spatulas	600	USA Plaster spreaders	1194
Tonometer	23	USA Tissue forceps	206
Tonsil abscess forceps	623	USA Umbilical cord scissors	102
Tonsil dissectors	622, 623	Uterine cannula	915
Tonsil grasping forceps	620	Uterine curettes	900, 924-930
Tonsil knife and enucleator	622	Uterine depressor	900
Tonsil knives	57, 623	Uterine dilators	897
Tonsil needles	72, 626	Uterine dressing forceps	353, 909, 910
Tonsil scissors	116, 117	Uterine probes	899
Tonsil snares	623, 624	Uterine scissors	98-100, 151, 152
Tonsil TC scissors	174	Uterine scoopes	911
Tonsillectomes	625	Uterine SCT scissors	186
Tounge holding forceps	618	Uterine TC scissors	163, 164
Tourniquet	1181	Uterine tenaculum forceps	901-908
Towel clamps	367-369	V	
TOWNLEY Caliper	22	Vaginal speculas	880-895
TOYNBEE Ear speculas	725	VALLEIX Uterine probes	899
Trachea tubes	654, 655	Valves	565
Tracheal dilators	654	VAN BUREN Dilating bougies	950
Tracheal retractor	655	VAN BUREN Sequestrum forceps	1118
Tracheostomy trocar	653	VAN DOREN Cervical biopsy and specimen forceps	918, 919
Traction bar for bone clamps	1126	VANNAS Micro scissors	140
Traction handle	936	VARADY Micro dissector	814
Transformers	27, 42-43	VARADY Phlebextractor	814
Transplantation knives	58	VARADY Phlebodissector	814
TRAUBE Percussion hammer	17	VARADY Varicose vein probe Set	807
TRAUTMANN Chisels	1029	Varicose vein instruments	815
TRAUTMANN Gouges	1029	Varicose vein probe Set	806, 807
TRAVERS Wound spreaders, self retaining	456	Vascular and tumor forceps	214, 216, 218
TRELAT Raspatories	1053	Vascular dilators	808, 809
TRELAT Vaginal speculas	882	Vascular dissectors	814
TREVES Tissue forceps	216	VASCULAR Needle holders	498
Trigeminal knives	56, 57	Vascular scissors	115, 117, 131-137, 158
Trocars	69-71	Vascular SCT scissors	191
Trocars for sinus surgery	692	Vascular TC scissors	179, 180
TROELTSCH Ear and nasal dressing forceps	221	VEDDER Tonsil snares	624
TROELTSCH-JALASVIRTA Ear and nasal dressing forceps	221	VEIDENHEIMER Sigmoid anastomosis forceps	857
TROEMMER Percussion hammer	16	Vein cannulas	72
TROUSSEAU Tracheal dilators	654	Velum retractor	627
TROUTMAN-CHRIS Blade breakers	47	Vena cava clamps	347, 348
TROUTMAN-CHRIS Blade holders	47	Ventricel of cerebrum puncture cannulas	80
TUBBS Aorta dilators	810	VERBRUGGE Bone holding forceps	1124
Tubing clamps	370-371	VERHOEVEN Suction tubes	89
TUEBINGEN Gall stone forceps	878	VERRES Insufflation cannula	73
TUEBINGEN Micro forceps	227	Vessel dilators	827
TUEBINGEN Micro scissors	140	Vessel irrigation cannulas	73
TUEBINGEN Retractors	414	Vessel knife	827, 838
TUEBINGEN Wound spreaders, self retaining	449	Vessel spreader	827
TUFFIER Intestinal and tissue grasping forceps	365	VICKERS Dissectors	1052
TUFFIER Retractors	403	VICKERS Drill Handles	1156
TUFFIER Rib Spreader	780	VICKERS Elevators	1052
Tumor forks	828	VICKERS Finger retractor	1183
Tumor knives	836, 837	VICKERS Hand restrainer	1182
Tuning forks	713-715	VICKERS Retractors	428

VICKERS Wound spreaders	1183	WILDER Lachrymal probes	63
VIDAL Lupus scraper	60	WILLET Scalp flap forceps	936
VIENNA Ligature catcher	513	WILLET-MARTEL Intestinal and tissue grasping forceps	366
Vigorimeter	21	WILLIAMS Intestinal and tissue grasping forceps	360
VIRCHOW Autopsy knives	54	WILLIAMS Wound spreaders, self retaining	464
VIRCHOW Brain knives	55	WILLIGER Bone curettes	1094, 1096
VIRCHOW Skull brakers	1021	WILLIGER Elevators	1074
VOLKMANN Bone curettes	1092, 1096, 1104, 1105	WILLIGER Mallets	1016
VOLKMANN Retractors	374, 378	WILLIGER Raspatories	1053
VOLLMAR Ring strippers	808	WILLIGER Retractors	420
VOLLMAR Vessel irrigation cannulas	73	WILMER-WALTER Nasal scissors	122
VOLTOLINI Nasal speculas	660	WILSON Uterine tenaculum forceps	904
Vomer forceps	696, 697	WINTER Placenta and ovum forceps	939, 940
Vulva spreader	896	Wire cutting forceps	1164-1170
W		Wire cutting scissors	148
WACHENFELDT Clip applying forceps	517	Wire cutting TC scissors	180
WAGENER Retractors	429	Wire forceps	1159-1163
WAGNER Bending instruments	1170	Wire guides	747, 752, 1158, 1159
WAGNER Bone levers	1076, 1080, 1081	Wire mesh	1155
WAGNER Delicate surgical scissors	125, 126	Wire saws	1010
WAGNER Delicate surgical TC scissors	177	Wire traction bows	1154, 1155
WAGNER Gouges	1049	WIS-FOREGGER Laryngoscopes	39
WAGNER Laminectomy rongeurs	985, 986	WITTNER Cervical biopsy and specimen forceps	920
WAGNER Mallets	1014	WOLFF Lupus curettes	60
WAGNER Raspatories	1070	WOLFF Plaster spreaders	1194
WALB Post mortem knives	55	WOODSON Dura dissectors	812
WALDMANN Episiotomy scissors	101, 152	Wound spreaders, self retaining	445-464
WALDMANN Episiotomy TC scissors	162	WRIGLEY Obstetrical forceps	935
WALDMANN Perineum scissors	101, 152	WUERZBURG Tongue depressors	616
WALDMANN Perineum TC scissors	162	WULLSTEIN Micro cup-shaped forceps	739
WALLICH Uterine scoopes	911	WULLSTEIN Raspatories	1054
WALTER Alar nasal hooklets	688	WULLSTEIN Suction handle	85
WALTER Chisels	682	WULLSTEIN Suction tubes	77, 86
WALTER Gouges	1033	WULLSTEIN Wound spreaders, self retaining	447
WALTER Osteotomes	682	YANKAUER Suction tubes	81, 82
WALTON Finger ring saws	1011	Y	
WALTON Rectal biopsy forceps	869	YASARGIL Dissector	835
WALTON-YANKAUER Suction tubes	81	YASARGIL Galea hooks	545
WANGENSTEEN Dissecting TC forceps	233	YASARGIL Laminectomy rongeurs	1005
WANGENSTEEN Needle holders	494	YASARGIL Ligature guide	829
WANGENSTEEN TC Needle holders	527	YASARGIL Raspatory	835
WANGENSTEEN Tissue grasping forceps	204	YASARGIL Suction tubes	80
WARTENBERG Algesimeter	20	YASARGIL Vessel knife	838
WARTENBERG pinwheel	20	YASARGIL-NICOLA Micro grasping forceps	651
WASSMUND Retractors	380	YEOMANN Rectal biopsy forceps	869
Waste forceps	1218	YOUNG Prostatic retractors	953
Water jet pistol	1226	YOUNG Toungue holding forceps	618
WATSON Dermatome	59	YOUNG-HRYNTSCHAK Ligature needles	513
WATSON-CHEYNE Dissectors	1056	Z	
WATSON-JONES Bone levers	1076	ZANDER Reamers	1012
WATSON-WILLIAMS Nasal forceps	993, 994	ZAUFAL Ear lever	730
WAUGH Tissue forceps	206	ZAUFAL-JANSEN Bone rongeurs	1133
WEBER Aesthesiometer	20	ZAUFAL-JANSEN Ear hooks	731
WEBER Atraumatic vascular clamps	312	ZENKER Dissecting and ligature forceps	262, 263
WEBER-LOCH Ear loops	729, 730	ZENKER Retractors	391
WEBSTER Needle holders	491	ZIEGLER Cilia forceps	223
WEBSTER TC Needle holders	525	ZIEGLER Dura knives	57
WECKER Micro scissors	139	ZIEGLER Reflex head mirror	35
Wedge osteotomes	1035	ZIELKE Gouges	1044
WEIL-BLAKESLEY Ethmoid forceps	745	ZOELLNER Ear speculas	720
WEIL-BLAKESLEY Nasal forceps	988, 989	ZOELLNER Hook	752
WEISMAN Ear curettes	729	ZOELLNER Lancet knife	752
WEISSBARTH Vaginal speculas	895	ZOELLNER Micro needle	752
WEITLANER Wound spreaders, self retaining	446, 447, 453, 454	ZOELLNER Raspatory	752
WEITLANER-BABY Wound spreaders, self retaining	449	ZOELLNER Round cutting knives	752
WELLER Meniscus and cartilage grasping forceps	1145	ZOELLNER Sickle knife	752
WERTHEIM Hysterectomy Forceps	271, 272	ZOELLNER Suction tubes	89
WERTHEIM Sigmoid anastomosis forceps	859	ZOELLNER Wire guide	752
WERTHEIM TC Hysterectomy scissors	166	Z-PARAMETRIUM Hysterectomy Forceps	286
WERTHEIM Uterine scissors	100		
WERTHEIM-CULLEN Hysterectomy Forceps	276		
WEST Chisels	1025		
WEST Gouges	1025		
WESTCOTT Micro scissors	141		
WESTMACOTT Tampon and polypus forceps	669		
WHITE Tonsil grasping forceps	620		
WHITEHEAD Mouth gags	604		
WIEDER Tongue depressors	602		
WIEN Nasal speculas	662		
WIENER Antrum rasps	693		
WIENER MOD. Hysterectomy Forceps	274		
WIGMORE Plaster knives	1195		
WIKSTROEM Dissecting and ligature forceps	269		



A			
Abajalenguas	601, 602, 615, 616		
ABRAHAM Bisturí para amígdalas	57		
ABRAHAM Pinzas para amígdalas	621		
Abrebocas	603-614		
Adenótomos	630		
ADLERDYCE Elevadores	1055		
ADLERKREUTZ Pinzas para vasos y tumores	214		
ADSON Escariadores	1012		
ADSON Ganchos para dura-madré	554, 555		
ADSON Periostótomos	1059		
ADSON Pinza-guía para taladros	1012		
ADSON Pinzas de disección	198, 199		
ADSON Pinzas haemostáticas	245, 256		
ADSON Pinzas quirúrgicas	209, 210		
ADSON Pinzas-gubias	1131		
ADSON Porta-agujas	489		
ADSON Separadores, autoestáticos	453, 455, 458-461		
ADSON TC Pinzas de disección	232		
ADSON TC Pinzas quirúrgicas	234		
ADSON Tubos para aspiración	78		
ADSON-BIEMER-MICRO Pinzas quirúrgicas	211		
ADSON-BROWN Pinzas quirúrgicas	217		
ADSON-BROWN TC Pinzas quirúrgicas	235		
ADSON-DE BAKEY Pinzas atrauma	218		
ADSON-GRAEFE Pinzas quirúrgicas	217		
ADSON-MICRO Pinzas de disección	199		
ADSON-MICRO Pinzas quirúrgicas	210, 211		
ADSON-MICRO TC Pinzas de disección	232		
ADSON-MICRO TC Pinzas quirúrgicas	234		
ADSON-MINI Pinzas quirúrgicas	210		
AGNEW Aguja para paracentesis	736		
Agrafes de sutura	516		
Aguja de cerumen y aplicadores de algodón	730		
Aguja del cardioplegia	823		
Aguja hipodérmica	72		
Aguja para amígdalas	72, 626		
Aguja para el tabique nasal	72		
Aguja para heparín	73		
Aguja para ligaduras	626		
Aguja para sutura del paladar	626		
Agujas	29, 841		
Agujas de guía	66-68		
Agujas especiales	72-74		
Agujas para la punción ciega del hígado	74		
Agujas para ligaduras	500-509		
Agujas para paracentesis	735-737		
Agujas para punción del esternón	73		
Agujas pasa-hilos	1158, 1159		
Agujas quirúrgicas	514-516		
Alambre para amigdalotomo	624, 652, 671, 738		
ALAN-PARKS Separadores para el recto	865		
ALDINGER Elevadores para huesos	1081		
ALEXANDER Cinceles	1030		
ALEXANDER Gubias	1030		
ALEXANDER Periostótomos	1065		
ALEXANDER Pinzas saca-bocados para biopsia	920		
Algesímetro (rueda con espinas)	20		
Algesímetro con aguja y cepillo	20		
Alicates corta-alambres	1164-1170		
ALLEN Pinzas-clamps intestinales	844		
ALLIS Pinzas intestinales y para tejidos	363, 364		
ALLIS-ADAIR Pinzas intestinales y para tejidos	365		
ALLISON Espátulas pulmonares	800		
ALM Separadores, autoestáticos	446		
ALY Algesímetro	20		
Amigdalotomos	625		
Aminoscopio	864		
Amniótomo	903		
ANDERSON-ADSON Separadores, autoestáticos	453		
ANESTOPHONE Estetoscopio	19		
Anillos ligatura	866		
ANKENEY Separadores costales	774, 783		
Anoscopios	862, 863		
ANVIL Pinzas para cortar uñas	1206		
Apparechio per arrestare	29		
Aproximadores para costillas	800		
ARKANSAS Piedra afiladore	58		
ARRUGA Porta-agujas	496		
ARRUGA TC Porta-agujas	531		
Abdominal KIT II	481		
Asas auriculares	728-730		
ASCH Curette secreción	911		
ASH Pinzas para tabique nasal	698		
Atomizadores	761		
AUFRICHT Escofi nas nasales	1085, 1090		
AUFRICHT Separadores nasales	687		
AUFRICHT Tijeras para la cirugía plástica	115		
AUVARD Espéculos vaginales	895		
AYRE Bisturí para cono	56		
B			
BABCOCK Pinzas intestinales y para tejidos	362, 363		
BABINSKY Martillo para reflejos	17		
BABY-ADSON Pinzas de disección y ligaduras	269		
BABY-ALLIS Pinzas intestinales y para tejidos	363		
BABY-COLLIN Separadores abdominales	466		
BABY-CRILE Pinzas haemostáticas	248, 257		
BABY-CRILE-WOOD TC Porta-agujas	523		
BABY-KOCHER Pinzas-clamps intestinales	844		
BABY-MIKULICZ Pinzas para peritoneo	277		
BABY-MIXTER Pinzas de disección y ligaduras	270		
BABY-MOSQUITO Pinzas haemostáticas	251		
BABY-OVERHOLT Pinzas de disección y ligaduras	270		
BABY-ROUX Separadores	416		
BABY-SATINSKY Pinzas de vena cava	347		
BABY-TISCHLER Pinzas saca-bocados para biopsia	921		
BABY-YANKAUER Tubos para aspiración	81		
BACKHAUS Pinzas de campo	367		
BACKHAUS-KOCHER Pinzas de campo	367		
BACON Pinzas-gubias	1129		
BAGDLEY Separadores para laminectomía	559		
BAILEY Pinzas cortantes para laminectomía	1007		
BAILEY-GIBBON Aproximadores para costillas	800		
BAINBRIDGE Pinzas haemostáticas	246		
BAINBRIDGE Pinzas vasculares atraumáticas	314		
BAKES Dilatadores para conducto biliar	872		
BALFOUR Separadores	485		
BALFOUR Separadores abdominales	470		
BALFOUR USA Separadores abdominales	471		
BALFOUR-BABY Separadores abdominales	469		
BALL & SOCKET Pinzas de campo	368		
BALLENGER Cuchillos para tabique nasal,	679		
BALLENGER Gubias	679		
BALLENGER Pinzas para amígdalas	621		
BALLENGER-HAJEK Elevadores para tabique nasal	676		
Bandejas para instrumentos	1215, 1216		
BARANY Ensordecedor	716		
BARBARA Micro aguja	748, 749		
BARNES Tubos para aspiración	88		
BARNHILL Cuchillos para adenoides	629		
BARON Tubos para aspiración	88		
BARR Separadores para el recto	861		
Barra de tracción para pinzas porta-huesos	1126		
BARRAQUER Micro-tijeras	140		
BARRAQUER Pinzas depilatorias	223		
BARRON Ligadores hemorroides	867		
BARSKY Separadores	442		
BARTH Cucharillas cortantes	1092		
BARTH Curetas auriculares	730		
Bastidor de soporte para abre bocas	617		
Bastidor para esterilizar y conservar	1225		
BAUMGARTNER Pinzas para extraer alambres	1159		
BAYHA Mangos de bisturíes	44		
BAYONET-KERRISON Pinzas cortantes para laminectomía	968-975		
BEACHAM Amniótomo	903		
BEALE Ganchito	748		
BEALES Cuchillo para el tendón	745		
BECK Pinzas cortantes para laminectomía	994		
BECKMANN Cuchillos para adenoides	628		
BECKMANN Espéculos nasales	662		
BECKMANN Separadores, autoestáticos	459		
BECKMANN-ADSON Separadores, autoestáticos	462		
BECKMANN-EATON Separadores, autoestáticos	463		
BEEBEE Cizallas corta-alambres	148		
BEER Pinzas depilatorias	223		
BEESON Separadores para escayolas	1193		
BELLUCCI Micro tijeras auriculares	740		
BENNETT Elevadores para huesos	1082		
BENGOLEA Pinzas haemostáticas	243, 255		
BENSAUDE Anoscopios	862		
BENSON Pinzas-clamps intestinales	852		
BERGER Pinzas saca-bocados para biopsia	920		
BERGMANN Bisturíes para disección	51		
BERGMANN Martillos	1015		
BERGMANN Separadores	434		
BERGMANN Sierra para escayolas	1195		

BERGMANN Tijeras para vendajes y Cizallas para escayolas	1190	BRUENINGS Lupas auriculares	727
BERLIN Curetas para biopsia	913	BRUENINGS Pinzas para Broncho-esofagoscopia	637
BERLIN Pinzas para tubos	370	BRUENINGS Pinzas para tabique nasal	697
BERLINER Martillos para reflejos	16	BRUENINGS Tubos de extensión	636
BERNHARD Pinzas de campo	368	BRUENINGS-BRUNK Separadores nasales	687
BERTILON Calibrador	20	BRUENINGS-LUCAS Cinceles	1029
BETHUNE Costótomos	765	BRUENINGS-LUCAS Gubias	1029
BEYER Pinzas-gubias	1130, 1133	BRUNETTI Cinceles	1049
BIEMER Retractores vasculares	827	BRUNNER Agujas para ligaduras	502, 509
BILL Tractor adecuado	936	BRUNNER Costótomos	768
BILLEAU Asas auriculares	729	BRUNNER Pinzas para anastomosis de recto	855
BIRCHER Bisturías para menisco	1147	BRUNNER Separadores	396-398, 415
BIRCHER Pinzas para menisco y cartilago	1145	BRUNNER Sondas conductoras	509, 511
BIRCHER Separadores para rodilla	1148	BRUNS Cucharillas cortantes	1095, 1106, 1107
BIRCHER-GANSKE Pinzas para menisco y cartilago	1145, 1146	BRUNS Tijeras para vendajes y Cizallas para escayolas	1190, 1191
BIRKETT Pinzas haemostaticas	249	BRYANT Pinzas para vendajes	352
Bisturías de lanceta	837	BUCHWALD Espátulas linguales	600
Bisturías falcivorne	691	BUCK Curetas auriculares	728
Bisturías para absceso	57	BUCK Martillo para reflejos	16
Bisturías para cono	56	BUCK Miringotomo	735
Bisturías para fibroma	56	BUCK Pinza para cuerpos extraños	731
Bisturías para amígdalas	57, 623	BUCK Tijeras para ligatures	147
Bisturías para disección	51	BUCK-GRAMCKO Elevadores para huesos	1075
Bisturías para dura-madré	57, 58	BUECHS Periostótomos	1063
Bisturías para fístulas	56	BUELAU Trócares	70
Bisturías para menisco	1146, 1147	Bujías dilatadoras	949, 950
Bisturías para nervio trigémino	56, 57	BUMM Curetas uterinas	928, 929
Bisturías para uso único	49	BUMM Pinzas para pólipos uterinos y ovarios	356
BLAKE Pinzas para los cálculos biliares	877	BUNNELL Mondador de tendones	1152, 1153
BLAKESLEY Pinzas nasales	757	BUNNELL Perforadores de mano	1172
BLAKESLEY-WIGAND Pinzas nasales	991	BUNT Imperdibles para instrumentos	372
BLOHMKE Pinzas para amígdalas	621	BURFORD Separadores costales	775-777
BLOUNT Separadores para rodilla	1149	BURKE Pinzas saca-bocados para biopsia	920
BLUMENTHAL Pinzas-gubias	1128	BUSCH Tijera umbilicales	102
BOEHLER Pinzas cortantes para huesos	1142	BUSHE Cucharillas cortantes	1113
BOEHLER Pinzas-gubias	1132	C	
BOERMA Forceps obstétrico	934	CAIRNS Pinzas haemostaticas	251
BOETTCHER Tijeras para amígdalas	116	Cajas para almacenaje	1225
BOIES Elevadores para fracturas nasales	698	Cajas para instrumentos	1216, 1217
Bolso de la emergencia	28	Calibrador	20, 22
BONACCOLTO Pinza para sutura	198	CANADIAN Bisturías para menisco	1147
BONN Micro pinzas	227	Cánula para irrigación del seno maxilar	88
BONN Tijeras finas para cirugía	129	Cánula para punción del seno maxilar	69, 70, 87
BONNEY Pinzas de disección	203	Cánula para uterine	915
BONNEY Pinzas intestinales y para tejidos	360	Cánulas para insuflación	73
BONNEY Pinzas quirúrgicas	215	Cánulas para irrigación vascular	73
BONNEY TC Pinzas de disección	233	Cánulas para la punción del ventriculo cerebral	80
BONNEY TC Pinzas quirúrgicas	235	Cánulas para venas	72
BOROWSKI Separadores para aorta	817	Cánulas traqueales	654, 655
BOSE Separadores, autoestáticos	445	CAPLAN Tijeras para tabique nasal	700
BOSE Separadores para tráquea	655	Cápsulas de petri	1214
BOUCHERON Espéculos auriculares	723	Captador de hilos	513, 627
BOWLES Estetoscopio	18	CARDIOBASE Separadores costales	798, 799
BOWMAN Estilete para el canal lacrimal	62	CARDIOPHONE Estetoscopio	19
BOYNTON Porta-agujas	497	Cargador de batería	42
BOYS-ALLIS Pinzas intestinales y para tejidos	365	CARMALT Pinzas para espinas	225
BOZEMANN Pinzas para tampones	353	CAROLL Goniómetro para dedos	20
BOZEMANN Porta-agujas	493	CAROLL Pinzas para pasar tendones	1151
BOZEMANN TC Porta-agujas	526	CARPENTER Cuchillo y enucleador para amígdalas	622
BOZEMANN Tijeras vasculares	131	CARPENTER Disectores para amígdalas	622
BOZEMANN-DOUGLAS Pinzas para tampones	353	CARREL Pinzas haemostaticas	251
BRAND Pinzas para pasar tendones	1152	CASPAR Cucharillas cortantes	1101-1103
BRAUN Craneoclasto	938	CASPAR Curetas	1110
BRAUN Depresores uterinos	900	CASPAR Disecador	832, 833
BRAUN Espéculos vaginales	892	CASPAR Empujador de sutura	828
BRAUN Ganchos para decapitación	937	CASPAR Espéculos para la cirugía lumbar vertebral	585
BRAUN Pinzas para coger el cuello de útero	901, 908	CASPAR Ganchos para exploración y coagulación	834
BRAUN-STADLER Tijeras para episiotomía	101	CASPAR Mangos de bisturías	825
BRAUN-STADLER Tijeras para perineo	101	CASPAR Periostótomos	562, 563
BREISKY Espéculos vaginales	894	CASPAR Pies de rey para	559
BREISKY WIENER Espéculos vaginales	894	CASPAR Pinzas cortantes para laminectomía	987, 1000-1004
BRIDGE Pinzas de disección y ligaduras	264	CASPAR Pinzas cortantes para laminectomía, desmontable	1002, 1003
BRODIE Sondas acanaladas	64	CASPAR Pisón	1024
BROM Separadores	431	CASPAR Separadores	388
Bronchoscopia	658, 659	CASPAR Separadores para la cirugía lumbar vertebral	582, 584
BROPHY Pinzas de disección	202	CASPAR Separadores para la columna cervical	568-579
BROPHY Pinzas quirúrgicas	214	CASPAR Separadores para la raíz de nervios	552
BROWN Pinzas para agrrar tejidos	217	CASPAR Separadores para laminectomía	564-567
BROWN Porta-agujas	490	CASPAR Sistema distractor para el cuerpo vertebral cervical	560, 561
BRUENINGS Bisturíe para amígdalas	57	CASTANEDA Pinzas vasculares para recién nacidos	298-299
BRUENINGS Cierre-nudos para amígdalas	623	CASTANEDA Separadores costales	773, 774
BRUENINGS Cuchillos para el tabique nasal	672	CARSTENS Trócares	70
BRUENINGS Espátulas linguales	600	CASTROVIEJO Estilete para el canal lacrimal	63



CASTROVIEJO Micro pinzas	226	CONVERSE Separadores nasales	687
CASTROVIEJO Micro-tijeras	138, 139	COOLEY Dilatadores para aorta	810
CASTROVIEJO Porta-hojas	47	COOLEY Dilatadores vasculares	808
CASTROVIEJO Rompe-hojas de afeitar	47	COOLEY Gancho auricular	797
CATLIN Cuchillos para amputación	52	COOLEY Pinzas atrauma	219, 220
CAWOOD-MINNESOTA Separadores para labios y mejillas	618	COOLEY Pinzas vasculares atraumáticas	304, 305, 326, 330, 335-339, 342-345
Cepillo de limpieza	1227	COOLEY Separadores costales	769-771, 788, 789
Cepillo de uñas	1227	COOLEY Separadores para atrio	816
CHADWICK Tijeras finas para cirugía	123	COOLEY Tubos para aspiración	83
CHAPUT Pinzas intestinales y para tejidos	366	COOLEY-BECK Pinzas vasculares atraumáticas	340
CHARNLEY Separadores abdominales	475	COOLEY-LEITZ Pinzas vasculares atraumáticas	340
CHARRIÉ Sierras para amputación y resección	1009	COOPER Agujas para ligaduras	502
CHEATTLE Pinzas para esterilización	1209	COPE Separadores	440
CHELSEA Proctoscopios	862	CORDES Pinzas para Broncho-esofagoscopia	637
CHERON Pinzas para tapones	354	CORWIN Pinzas para extraer alambres	1160
CHEVALIER Separadores costales	781	CORYLLOS Costótomos	766
CHEVALIER-JACKSON Cánulas traqueales	655	CORYLLOS Separadores	395
CHILDE Pinzas aplicadoras para agrafes	517	Costótomos	764-768
CHURCH Tijeras vasculares	132	COTTLE Cinceles	680, 681
Cierra-nudos para amígdalas	623, 624, 627	COTTLE Cuchillos para rinoplastia	673
Cierra-nudos para laringología	652	COTTLE Elevadores para tabique nasal	677, 678
Cierre de la pinza	936	COTTLE Escofi nas nasales	1084
Cinzel para esternón	764	COTTLE Espéculos nasales	666-668
Cinceles	680-682, 751, 1025-1051	COTTLE Ganchito para alas de nariz	688, 689
Cinzel rompe-craneo	1021	COTTLE Martillos	1013
CINELLI Osteótomos	683	COTTLE Osteótomos	680, 1031
Cinta de celuloide	35	COTTLE Periostótomos	1060
CITELLI Pinzas cortantes para laminectomía	958	COTTLE Pinza de fijación	686
CITELLI-BEYER Pinzas cortantes para laminectomía	958	COTTLE Pinza para columela	686
Cizallas corta-alambres	148	COTTLE Separadores nasales	690
Clamp umbilical	937	COTTLE TC Tijeras para amígdalas	174
Clamps Bulldog	288-297	COTTLE Tijeras nasales	120, 122
CLAR Lámpadas frontales	26	COTTLE Torchio per cartilagine	686
CLASSON Tijeras vasculares	132	COTTLE-KAZANJIAN Pinzas cortantes para huesos	1141
CLAUS V. EICKEN Aguja para amígdalas	626	COTTLE-KNAPP Tijeras nasales	122
CLEVELAND Pinzas cortantes para huesos	1141	COTTLE-MASING Tijeras nasales	122
CLEVELAND Pinzas-gubias	1128	COTTLE-NEIVERT Ganchito para alas de nariz	689
CLOVER Pinzas para amígdalas	620	COTTLE-WALSHAM Pinzas para tabique nasal	698, 699
CLOWARD Pinzas cortantes para laminectomía	1006	COUPLAND Tubos para aspiración	82
CLOWARD Separadores para cuerpos vertebrales	592, 593	CRAFOORD Pinzas de disección y ligaduras	266
CLOWARD Separadores para la columna cervical	580, 581	CRAFOORD Tijeras para ginecología	101
CLOWARD Separadores para la raíz de nervios	553	CRAFOORD-SELLORS Pinzas de disección y ligaduras	266
COAKLEY Cánula para punción del seno maxilar	71	CRAIG Pinzas para tabique nasal	696
COAKLEY Curetas para el seno maxilar	690-692	Craneoclasto	938
COBB Curetas	1112	CREDO Cuchillas corta-callos	1207
COBB Elevadores	1072, 1073	CRILE Pinzas haemostaticas	248, 258
COBB Gubia espinal	1050	CRILE Porta-agujas	497
COBETT Dermátomos	59	CRILE Separadores	419, 430
COBRA Pinzas vasculares atraumáticas	318	CRILE-MURRAY Porta-agujas	490
COEN Cánula para uterine	915	CRILE-RANKIN Pinzas haemostaticas	246, 257
COHEN Periostótomos	1055	CRILE-WOOD Porta-agujas	490
COLCLOUGH Pinzas cortantes para laminectomía	984	CRILE-WOOD TC Porta-agujas	522
COLLER Pinzas haemostaticas	246	CRUTCHFIELD Pinzas de tracción craneal	548
COLLIER Porta-agujas	492	Cubetas para soluciones	1212
COLLIN Clamp umbilical	937	Cubetas redondas	1212, 1214
COLLIN Dinamómetro	20	Cucharilla para la vesicula biliar	873
COLLIN Espéculos vaginales	880	Cuchara medicinal	1213
COLLIN Mangos de bisturíes	47	Cucharas para cálculos biliares	873, 874
COLLIN Martillos	1016	Cucharilla	706, 707, 831, 832, 840, 841
COLLIN Pelvímetro	931	Cucharilla de cerumen y ganchitos	730
COLLIN Pinzas aplicadoras para agrafes	518	Cucharillas cortantes	751, 1091-1114
COLLIN Pinzas intestinales y para tejidos	361	Cucharillas para aborta y placenta	942
COLLIN Pinzas para el útero	910	Cucharillas uterinas	924
COLLIN Pinzas para sacar órganos	358	Cuchillas corta-callos	1207
COLLIN Pinzas para vendajes	354	Cuchillo de discision	745
COLLIN Pinzas tira-lengua	618	Cuchillo del tumor	836, 837
COLLIN Separadores	420	Cuchillo en forma de hoz	745, 746, 748, 752
COLLIN Separadores abdominales	466, 467	Cuchillo en forma de rollo	746
COLLIN-DUVAL Pinza para agrar	204	Cuchillo interóseo	53
COLLIN-HARTMANN Separadores	416	Cuchillo lanceolado	747, 752
COLLIN-LOKTITE Separadores abdominales	467	Cuchillo para dura-madré	553
COLLYER Pelvímetro	931	Cuchillo para el tendón	745
Columna vertebral KIT	482	Cuchillo para furúnculo	735
COM separadores	1057	Cuchillo para lóbulos	52, 745
Compresores urétral	946	Cuchillo para mucosa	745
Compresor	1181	Cuchillo para periostio	53, 735
Conductor de tendones	1153	Cuchillo y enucleador para amígdalas	622
Conductor para sierras de hilo	549	Cuchillos para adenoides	628, 629
CONE Curetas anulares	1111	Cuchillos para amputación	52
CONE Pinzas saca-bocado craneal	549	Cuchillos para autopsia	54, 55
CONVERSE Cuchillos para rinoplastia	673	Cuchillos para cartilago	53, 54
CONVERSE Ganchito para alas de nariz	688	Cuchillos para cerebro	55
CONVERSE Osteótomos	682	Cuchillos para cortes redondos	746, 752, 753

Cuchillos para el tabique nasal	672, 673	DE MARTEL-WOLFSON Pinzas-clamps anastomosis	845
Cuchillos para escayolas	1195	DE MARTEL-WOLFSON Porta-clamp	845
Cuchillos para mucosa	673	DE VILBISS Pinzas saca-bocado craneal	549
Cuchillos para órganos	55	DEAN TC Tijeras para amígdalas	174
Cuchillos para rajar cartílagos	672	DEAN Tijeras para amígdalas	116
Cuchillos para resección	53, 54	DEAVER Separadores	426, 427, 485
Cuchillos para rinoplástica	672, 673	DEAVER Tijeras para cirugía	96
Cuchillos para tabique nasal	679	DECKER Pinzas cortantes para laminectomía	1006
Cuchillos para trasplante	58	DEJERINE Martillos para reflejos	16
Cuchillos para vasos	827, 838	DEMEL Agujas pasa-hilos	1158
Curetas	703, 704, 706-708, 1110-1112	DEMEL Instrumentos para cerclaje	1158
Curetas anulares	1111	DENHARDT Abrebocas	603
Curetas auriculares	728-730	DENNIS-BROWNE Pinzas para agrar tejidos	204
Curetas de aspiración	914	DENNIS-BROWNE Separadores abdominales	471
Curetas para biopsia	912-914	Depresor para epíglois	633
Curetas para el seno maxilar	690-692	Depresores uterinos	900
Curetas para lupus	60	DERF (WRIGHT) Porta-agujas	491
Curetas uterinas	900, 925-930	DERF TC Porta-agujas	525
Curette secreción	911	DERF-CONVERSE Porta-agujas	492
Curettes uterines	911	DERF-CONVERSE TC Porta-agujas	525
CUSCO Espéculos vaginales	880-882	Dermatología	60, 61
CUSHING Espátulas cerebrales	543	Dermátomos	59
CUSHING Ganchos para dura-madré	555	DERRA Pinzas vasculares atraumáticas	304
CUSHING Pinzas cortantes para laminectomía	995, 998	DESCHAMPS Agujas para ligaduras	503-508
CUSHING Pinzas de disección	202	DESJARDINS Cucharas para cálculos biliares	873
CUSHING Pinzas quirúrgicas	213	DESJARDINS Pinzas para los cálculos biliares	878
CUSHING Separadores	430, 437, 441, 444	DESJARDINS Pinzas para pedículo renal	282
CUSHING TC Pinzas de disección	233	DESJARDINS Sondas exploradoras para cálculos biliares	872
CUSHING-BROWN Pinzas quirúrgicas	216	DESMARRES Separadores	436
CUSHING-KOCHER Separadores	437	Detergente para instrumentos	1227
CUSHING-LANDOLT Espéculos para hipofisectomía	702	Diapasónes	713-715
CUZZI Cucharillas para aborta y placenta	942	DICK Pinzas-Clamps para histerectomía	276
CZERNY Pinzas para coger el cuello de útero	906	DIEFFENBACH Clamps Bulldog	292
CZERNY Separadores	420	DIETER Pinzas saca-bocado	744
CZERNY Separadores para el recto	861	DIETRICH Clamps Bulldog	291
D		DIETRICH Pinzas vasculares atraumáticas	334
DAHLGREN Pinzas saca-bocado craneal	549	DIETRICH-VASCULAR TC Porta-agujas	532
DAHMEN Gubias	1051	Dilatador para el cuello vesical	953
DAHMEN Osteótomos	1051	Dilatadores para aorta	810
DALE Pinzas vasculares atraumáticas	329	Dilatadores para conducto biliar	872
DANDY Ganchos para dura-madré	554	Dilatadores para el seno frontal	753
DANDY Pinzas haemostáticas	249, 258	Dilatadores uterinos	897
DANDY Tijeras vasculares	132	Dilatadores vasculares	808, 809, 827
DARDIK Pinzas vasculares atraumáticas	346	Dilatatore traqueales	654
DARLING Separadores, autoestáticos	452	Dinamómetro	20
DARTIGUES Pinzas para el útero	909	DINGMANN Abajalenguas	615
DAUBENSPECK Cucharillas cortantes	1099	DINGMANN Abrebocas	606
DAUTREY-MUNRO Osteótomos	1034	DINGMANN Pinza para huesos	1117
DAVIDSON Separadores	411	DIPLOMAT Manómetros para la presión de la sangre	25
DAVIS Espátula para íntima	813	Disecadores	703, 708, 753, 831, 832, 835, 840, 1052, 1056
DAVIS Pinzas para esterilización	1209	Disecadores de dura-madré	550, 551, 812, 813
DAVIS-BOYLE Abajalenguas	616	Disecadores vasculares	814
DAVIS-BOYLE Abrebocas	608-612	Disector esférico	840
DAVIS-MEYER Abajalenguas	616	Disectores para amígdalas	622, 623
DAVIS-MEYER Abrebocas	607	Dispensadores de algodón	1217
DAY Gnachitos auriculares	731	DITTEL Guía para catéteres	947
DE BAKEY Clamps Bulldog	288, 289	DIXON-LOVELACE Pinzas haemostáticas	247, 257
DE BAKEY Dilatadores vasculares	809	DOCKHORN Separadores	387
DE BAKEY Pinzas atrauma	219, 220	DOUAY Pinzas saca-bocados para biopsia	920
DE BAKEY Pinzas vasculares atraumáticas	300-303, 309-311, 313, 314, 316, 317, 321, 322, 325, 328, 330	DOUGHTY Abajalenguas	615
DE BAKEY Separadores costales	786, 787	DOUGLAS Cánula para punción del seno maxilar	71
DE BAKEY Separadores, autoestáticos	464	DOUGLAS Pinzas depilatorias	223
DE BAKEY TC Pinzas atrauma	236	DOYEN Abajalenguas	602
DE BAKEY TC Porta-agujas	522, 523	DOYEN Espéculos vaginales	893
DE BAKEY TC Tijeras vasculares	179	DOYEN Perióstótomos	1066, 1067
DE BAKEY Tijeras des disección	115	DOYEN Pinzas de campo	368
DE BAKEY Tijeras vasculares	134, 135	DOYEN Pinzas para pólipos uterinos y ovarios	356
DE BAKEY Tubos para aspiración	84	DOYEN Pinzas-clamps intestinales	844-847
DE BAKEY-BAHNSON Pinzas vasculares atraumáticas	310	DOYEN Porta-agujas	492
DE BAKEY-BECK Pinzas vasculares atraumáticas	305	DOYEN Separadores	402
DE BAKEY-CAROTIS Clamps Bulldog	297	DOYEN Separadores abdominales	480
DE BAKEY-DIETRICH Clamps Bulldog	294	DOYEN Sondas acanaladas	63
DE BAKEY-MIXTER Pinzas vasculares atraumáticas	300	DOYEN Tijeras abdominales	97, 98
DE BAKEY-MOSQUITO Pinzas vasculares atraumáticas	307	DOYEN Tirabuzóns para mioma	908
DE BAKEY-PEAN Pinzas vasculares atraumáticas	306	DOYEN-CHILD Separadores abdominales	480
DE BAKEY-RANKIN Pinzas vasculares atraumáticas	307	DOYEN-COLLIN Abrebocas	603
DE BAKEY-RUMEL Pinzas vasculares atraumáticas	300	DOYEN-JANSEN Abrebocas	603
DE BAKEY-SATINSKY Clamps Bulldog	297	DOYEN-STILLE Separadores	408
DE BAKEY-SATINSKY Pinzas vasculares atraumáticas	331	DRAFFIN Bastidor de soporte para abre bocas	617
DE LEE Forceps obstérico	932	DUBOIS Tijeras para decapitación	100
DE MARTEL Conductor para sierras de hilo	549	DUEHRSEN Pinzas de disección	203
DE MARTEL-WOLFSON Pinza para cerrar los clamps	845	DUEHRSEN Pinzas quirúrgicas	215
		DUKE Trócares	71



DUNN-DAUTREY Osteótomos	1026	FAURE Pinzas-Clamps para histerectomía	272
DUPLAY Pinzas para coger el cuello de útero	902	FAVALORO Tijeras vasculares	134
DUPLAY Pinzas para vendajes	351, 352	FAVALORO Separadores costales	775
DUPLEX Estetoscopios	18	FEHLAND Pinzas para anastomosis de recto	856
DUPUY-WEISS Aguja para ligaduras	626	FEILCHENFELD Pinzas para espinas	225
DURANTE Pinzas para vasos y tumores	218	FEIN Porta-algodones	633
DUVAL Pinza para agrarr	204	FELDHEIM Compresor	1181
DUVAL Pinzas intestinales y para tejidos	360, 361	FERGUSSON Cucharas para cálculos biliares	874
DUVAL-COLLIN Pinzas intestinales y para tejidos	361	FERGUSSON Pinza para huesos	1119
E		FERGUSSON Pinzas para anastomosis de recto	855
ECHLIN Pinzas-gubias	1135	FERGUSSON Pinzas-clamps intestinales	853
EDER Porta-algodones	66	FERGUSSON Tijeras para cirugía	97
EICKEN Cánula para irrigación del seno maxilar	88	FERGUSSON Tubos para aspiración	78, 79
EISELSBERG Porta-agujas	497	FERGUSSON-ACKLAND Abrebocas	603
EISELSBERG Tijeras para ligatures	147	FERRIS-SMITH Pinzas quirúrgicas	215
Elevador auricular	730	FERRIS-SMITH TC Pinzas quirúrgicas	235
Elevador de succión	674, 678	FERRIS-SMITH-CUSHING Pinzas cortantes para laminectomía	979-983
Elevador para cuerpos extraños	731	FERRIS-SMITH-CUSHING Pinzas cortantes para laminectomía, desmontable	981, 983
Elevador para luxación	1083	FERRIS-SMITH-KERRISON Pinzas cortantes para laminectomía	960-967, 978
Elevadores	737, 840, 1052-1056, 1072-1074	FICKLING Pinzas de disección y ligaduras	269
Elevadores para fracturas nasales	698	FILIFORM Bujías dilatadoras	949
Elevadores para huesos	1075-1083	FINOCHIETTO Pinzas de disección y ligaduras	280
Elevadores para tabique nasal	674-678	FINOCHIETTO Porta-agujas	494
ELSAESSER Pinzas para nefrostomía	876	FINOCHIETTO Separadores costales	771-773, 784, 785
EMMET Pinzas para vendajes	354	FINOCHIETTO TC Porta-agujas	527
EMMET Separadores	436	FINSEN Separadores, autoestáticos	445
Empujador de sutura	827, 828	FINSTERER Tubos para aspiración	84
Empujador de tumor	828	FISCHER Bisturís para amígdalas	623
Endoespéculos	896	FISCHER Mondador de tendones	1153
ENGEL Sierra para escayolas	1195	Flebodisecador	814
Ensordecador	716	Fleboextractores	808, 814
Enucleadores	705	Flexible naso-pharyngo-laryngofiberscopios	598
EPPENDORF Pinzas saca-bocados para biopsia	920, 922	FOERSTER Pinzas para tampones	359
Escariadores	1012	FOERSTER-BALLENGER Pinzas para tampones	359
Escofi nas nasales	1084-1090	FOMON Cuchillos para rinoplastia	672
Escofina para el seno maxilar	693	FOMON Escofi nas nasales	1086, 1090
Escofinas	1088, 1089	FOMON Ganchito para alas de nariz	688, 689
Escupidera	1214	FOMON Gancho en forma de anillo	689
Esfinteroscopios	863	FOMON Osteótomos	683
ESMARCH Cuchillos para escayolas	1195	FOMON SCT Tijeras nasales	189
ESMARCH Tijeras para vendajes y Cizallas para escayolas	1190	FOMON TC Tijeras para amígdalas	174
Espátula para íntima	813, 814	FOMON Tijeras nasales	118, 119, 121
Espátulas abdominales e intestinales	421	Forceps obstétrico	932-935
Espátulas cerebrales	543, 544	FORD-DIXON Ligadores hemorroides	868
Espátulas linguales	600	FORMBY Cucharilla de cerumen y ganchitos	730
Espátulas para emplasto	66	FOSTER-GILLIES TC Porta-agujas	528
Espátulas para la vesícula	953	FOWLER Bisturí para amígdalas	57
Espátulas pulmonares	800, 801	FOX Curetas para lupus	60
Espéculos auriculares	720-726	FRAENKEL Pinzas para Broncho-esofagoscopia	637
Espéculos nasales	660-668	FRAENKEL Pinzas para pólipos laríngeos	634, 635
Espéculos para el recto	861, 862	FRANCKE Aguja	29
Espéculos para hipofí sectomía	702	FRANZ Separadores abdominales	474
Espéculos para la cirugía lumbar vertebral	585	FRASER-KELLY Pinzas haemostaticas	248
Espéculos vaginales	880-895	FRAZIER Cánulas para la punción del ventriculo cerebral	80
Espejo frontal	35	FRAZIER Disecadores de dura-madré	551
Espejos laríngeos	632	FRAZIER Ganchos para dura-madré	555
Espejos para rinoscopia	632	FRAZIER Tubos para aspiración	77
Estesiometro	20	FREEMAN-GORNEY TC Tijeras para Face-lift	176
Estetoscopios	17-19	FREEMAN-KAYE TC Tijeras para Face-lift	176
Estetoscopios fetales	17	FREER Cinceles	1025
Estilete para el canal lacrimal	62, 63	FREER Cuchillos para mucosa	673
Estrigos para extensión	1154, 1155	FREER Elevadores	1054
Estuches para agujas	1222, 1223	FREER Elevadores para tabique nasal	674, 675
EVES Cierra-nudos para amígdalas	623	FREER Gubias	1025
EWALD Pinzas de disección	198	FREER Separadores	443
EWALD Pinzas quirúrgicas	209	FREER-GORNEY Elevador de succión	674
Excavador	747	FREER-JOSEPH Elevadores para tabique nasal	675
Extractore para comedones	61	FREER-YASARGIL Elevadores para tabique nasal	674
F		FRENZEL Espátulas linguales	600
FAHLBUSCH Cucharilla	707	FRIEDMANN-JOLL Separador de vulva	896
FAHLBUSCH Cureta	707	FRIEDMANN-MINI Pinzas-gubias	1127
FAHLBUSCH Micro-tijeras de agarre	651	FRIEDMANN-VICKERS Pinzas-gubias	1127
FANSLER Anoscopios	862	FRIETSCH Separadores	403
FARABEUF Periostótomos	1063	FRY Pinzas nasales	990
FARABEUF Pinza para huesos	1120	FRYKHOLM Pinzas-gubias	1136
FARABEUF Separadores	417	FUCHSIG Pinzas haemostaticas	247
FARABEUF-COLLIN Periostótomos	1063	FULLER Pinza para introducir para prótesis de teflon	742
FARABEUF-LAMBOTTE Pinza para huesos	1120	G	
FARRELL Porta-algodones	65	GALLAHER Escofi nas nasales	1085
FARRIOR Espéculos auriculares	720, 724	Ganchito	747, 748, 750, 752, 753
FAULKNER Curetas para el seno maxilar	690	Ganchito de estribo	747
FAURE Pinzas para peritoneo	278	Ganchito muy fi no	830
FAURE Pinzas saca-bocados para biopsia	916		

Ganchito para alas de nariz	688, 689	GROSS-MAIER Pinzas para vendajes	349, 350
Ganchito para el seno maxilar	747	GRUBER Espéculos auriculares	725
Ganchitos para nervios y vasos	822, 829	GRUENWALD Atomizadores	761
Gancho	706, 708, 831, 832, 841	GRUENWALD Pinzas nasales	757
Gancho auricular	792, 797	GRUENWALD-HENKE Pinzas nasales	991
Gancho de mentón	383, 1057	GRUENWALD-JANSEN Pinzas auriculares y nasales	222
Gancho en forma de anillo	689	Gubias	679, 751, 1025-1051
Gancho para galea	545	Gubias de esponjosa	1045
Ganchos para decapitación	937	Gubias espinal	1050
Ganchos para dura-madré	554, 555	Guía para catéteres	947
Ganchos para exploración y coagulación	834	Guía-ligadura	829
GARDNER Pinzas cortantes para huesos	1141	GUILLEN Elevador de succión	678
Garra para tejidos	830	GUILFORD-WRIGHT Cizallas corta-alambres	148
GARRETT Dilatadores vasculares	809	GULEKE Pinzas-gubias	1131
GAST Abajalenguas	615	GUNAR-HEY Pinzas para tubos	371
GAUSS Pinza para pericráneo	936	GUSTELLA Osteótomos	684
GELFOAM Pinzas para tabique nasal	701	GUTHRIE Separadores	432
GELLHORN Pinzas saca-bocados para biopsia	919	GUYON Bujías dilatadoras	949
GELPI Separadores	485	GUYON Guía para catéteres	947
GELPI-LOKTITE Separadores, autoestáticos	456, 457	GUYON Pinzas para pedículo renal	282-284
GELPI-SEILETZ Separadores, autoestáticos	457	GWYNE-EVANS Disectores para amígdalas	623
GEMINI Pinzas de disección y ligaduras	265	H	
GERALD Pinzas auriculares y nasales	222	HABERER Espátulas abdominales e intestinales	421
GERALD Pinzas de disección	202	HACKSTOCK Pinzas para extraer alambres	1161
GERALD Pinzas quirúrgicas	214	HAGLUND-STILLE Separadores para escayolas	1193
GERALD TC Pinzas de disección	233	HAIGHT Separadores costales	781
GERALD TC Pinzas quirúrgicas	235	HAJEK Martillos	1013
GERALD-BROWN Pinzas quirúrgicas	216	HAJEK Pinzas nasales	991
GERSTER Barra de tracción para pinzas porta-huesos	1126	HAJEK Tubos para aspiración	87
GERZOG Martillos	1017	HAJEK-CLAUS Pinzas cortantes para laminectomía	958
GERZOG-SEXTON Aguja para paracentesis	735	HAJEK-KOFLER Pinzas cortantes para laminectomía	959
GIERTZ-STILLE Costótomos	767	HAKANSSON Pinzas-gubias	1128
GIGLI Mango con gancho, para sierras de hilo	1010	HALLE Cucharillas cortantes	1098
GIGLI Sierras de hilo	1010	HALLE Cuchillo para dura-madré	553
GILLIES Osteótomos	1026	HALLE Elevadores para tabique nasal	674
GILLIES Pinzas de disección	199	HALSEY Porta-agujas	491
GILLIES Pinzas quirúrgicas	211	HALSEY TC Porta-agujas	524
GILLIES Porta-agujas con tijeras	495	HALSTED-MOSQUITO Pinzas haemostaticas	244, 250, 256, 258, 259
GILLIES Separadores	442	HARDY Cureta	707
GILLIES TC Pinzas quirúrgicas	234	HARDY Eucleadores	705
GILLIES TC Porta-agujas	528	HARDY Horquilla para implantar	705
GILLIES-MINI TC Porta-agujas	528	HARDY-FAHLBUSCH Disecadores	703
GILL-VERNET Separadores	438	HARGIS Seperador para el borde anterior	1057
GLASSMANN Pinzas atrauma	218	HARGIS Seperador para el cuerpo mandibular	1057
GLOVER Clamps Bulldog	290, 296	HARKEN Pincas de vena cava	348
GLOVER Pinzas vasculares atraumáticas	303, 315, 316	HARKEN Pinzas vasculares atraumáticas	334
GLUCK Costótomos	764	HARRINGTON Separadores	409
Gnachitos auriculares	730, 731	HARRINGTON Separadores	485
GOLDMANN Elevadores para fracturas nasales	698	HARRINGTON-PEMBERTON Separadores	409
GOLDMANN-FOX TC Tijeras para encías	177	HARTMANN (FRENCH) Diapasónes	713
GOLDMANN-FOX Tijera para encías	125	HARTMANN Abajalenguas	601
GOELET Separadores	418	HARTMANN Diapasónes	713-715
GOMEL Micro-tijeras	143	HARTMANN Espéculos auriculares	721-723
Goniómetro	20	HARTMANN Espéculos nasales	661, 662
Goniómetro para dedos	20	HARTMANN Gnachitos auriculares	731
GOOD Tijeras para amígdalas	117	HARTMANN Pinzas auriculares	732, 733
GOOD-SCHWEEKENDIECK Tijeras para amígdalas	117	HARTMANN Pinzas haemostaticas	250
GORNEY TC Tijeras para Face-lift	175	HARTMANN Pinzas nasales	992
GORNEY Tijeras des disección	113	HARTMANN Pinzas para pólipos auriculares	732
GORNEY-FREEMAN TC Tijeras para Face-lift	176	HARTMANN Pinzas para tamponamiento y pólipos nasales	669, 670
GOSSET Separadores abdominales	469	HARTMANN Pinzas-clamps intestinales	846
GOSSET-BABY Separadores abdominales	469	HARTMANN Pinzas-gubias	1129
GOURDET Cucharillas uterinas	924	HARTMANN Porta-algodones	633
GRAEFE Bisturries para disección	51	HARTMANN Sondas auriculares	716
GRAEFE Pinza para coger la piel	686	HARTMANN-HALLE Espéculos nasales	661
GRAEFE Pinzas para agrrar tejidos	209	HARTMANN-HOFFMANN Pinzas auriculares	733
GRAEFE Pinzas para iridectomía	197, 208	HARTMANN-NOYES Pinzas auriculares	733
GRAEFE Separadores	429, 431	HARTMANN-WEINGAERTNER Pinzas auriculares	733
GRAEFE Tijeras finas para cirugía	129	HARTMANN-WULLSTEIN Pinzas auriculares	732
GRAHAM Ganchos para dura-madré	554	HARVEY Cizallas corta-alambres	148
Grapas de plata	546	HARVEY-JACKSON Separadores, autoestáticos	463
GRAVE Espéculos vaginales	883, 884, 886, 887	HASLINGER Separador para velo del paladar	627
GRAY Pinzas de disección y ligaduras	280	HASOBUCCI Horquilla	706
GREEN-ARMYTAGE Pinza-clamp uterina	936	HATFIELD Cucharillas cortantes	1112, 1113
GREGORY Pinzas vasculares atraumáticas	326	HAYES Pinzas para anastomosis de recto	857
GREGORY SCT Tijeras para Face-lift	190	HEANEY Pinzas-Clamps para histerectomía	274
GREGORY TC Tijeras para Face-lift	175	HEANEY Porta-agujas	492
GREGORY-SOFT Clamps Bulldog	297	HEANEY TC Porta-agujas	526
GREVEN Micro pinzas para plegar alambre	741	HEANEY-RAZAK Pinzas-Clamps para histerectomía	274
GREY-TURNER Pinzas haemostaticas	256	HEANLEY Pinzas-gubias	1127
GRONINGEN Ganchos para dura-madré	554	HEART-GATE Aguja del cardioplegia	823
GROSS Asas auriculares	730	HEART-GATE Ganchitos para nervios y vasos	822
GROSS Pinzas para vendajes	350, 351	HEART-GATE Gancho auricular	792, 793



HEART-GATE Imán de barra	822	HUDSON Perforadores de mano	1172
HEART-GATE Instrumentos para como mínimo la cirugía	818-823	HUGHES Ganchito de estribo	747
HEART-GATE Mango de bisturí	823	HUMBY Dermátomos	59
HEART-GATE Pinza de introducción de la lámina auricular	820	HUNTER Pinzas para espinas	225
HEART-GATE Portas ligaduras	822	HURD Aguja para sutura del paladar	626
HEART-GATE Regla de la sutura	823	HURD Disectores para amígdalas	622
HEART-GATE Separadores costales	791, 792	HUSFELDT Pinzas vasculares atraumáticas	327
HEART-GATE Soportes de valve auriculares	820	I	
HEART-GATE Valve auriculares	820	I.M.A. Separadores mamaria	794-797
HEATH Martillos	1015	Imán de barra	822
HEATH Tijeras para ligatures	147	Imperdibles para instrumentos	372
HEGAR Dilatadores uterinos	897, 898	INGE Separadores para cuerpos vertebrales	592
HEGAR Porta-agujas	488	Instrumental cirugía cardiaca (corazón)	824
HEGAR TC Porta-agujas	521	Instrumental para grapar	546, 547
HEGAR-BAUMGARTNER Porta-agujas	490	Instrumento para remoer dispositivo tintrauterino	911
HEGAR-BAUMGARTNER TC Porta-agujas	524	Instrumentos de aspiración e irrigación	86-89
HEGAR-VASCULAR TC Porta-agujas	532	Instrumentos de flexión	1170
HEGEMANN-DIETRICH SCT Tijeras vasculares	191	Instrumentos para cerclaje	1158
HEGEMANN-DIETRICH TC Tijeras vasculares	180	Instrumentos para circuncisión	956
HEGEMANN-DIETRICH Tijeras vasculares	137, 158	Instrumentos para como mínimo la cirugía	818-823
HEGENBARTH Pinzas aplicadoras para agrafes	517	Instrumentos para cuerpos extraños	731
HEIFETZ Espátulas cerebrales	543	Instrumentos para examen y medidas	20-22
HEIMING Pinzas para nefrostomía	874	Instrumentos para introducir catéteres	947
HEISS Pinzas haemostaticas	244, 256	Instrumentos para microcirugía	827-841
HEISTER Abrebocas	603	Instrumentos para ORL	595-761
HELFFERICH-BIER Sierras para amputación y resección	1009	Instrumentos para sinuscopía	703-708
HEMINGWAY Cucharillas cortantes	1093	Instrumentos para varices	815
HENDERSON Separadores, autoestáticos	449	Insufladores de aire	716, 717
HENKE Disectores para amígdalas	622	IOWA Aguja hipodérmica	72
HENLEY Pinzas vasculares atraumáticas	331	IOWA Pinzas para coger el cuello de útero	905
HENLEY Separadores, autoestáticos	450, 451	IRIS SCT Tijeras finas para cirugía	191
HENNIG Separadores para escayolas	1193	IRIS TC Tijeras finas para cirugía	178
HEPP-SCHIEDL Micro-tijeras	143	IRIS Tijeras finas para cirugía	127-129, 157
HERBERHOLD Abajalenguas	616	Irrigadores	1215
HERMANN Cinceles	751	IRWIN Separadores, autoestáticos	456
HERMANN Gubia	751	ISRAEL Separadores	380
HERMANN Martillo	751	ITERSON Separadores para tráquea	655
HERRICK Pinzas para pedículo renal	283	IVES-FANSLER Anoscopios	863
HERTZLER Separadores costales	780	J	
HERZ Pinzas para menisco y cartilago	1145	JABALEY Tijeras finas para cirugía	130, 157
HERZ Pinzas para pasar tendones	1150	JACKSON Espéculos vaginales	893
HESS Clamps Bulldog	292	JACKSON Pinzas para pasar tendones	1150
HEY-GROVES Pinza para huesos	1123	JACKSON Separadores para tráquea	656
HEYMANN Pinzas para tabique nasal	696	JACKSON-BURROWS Separadores, autoestáticos	457
HEYMANN SCT Tijeras nasales	190	JACOBS Pinzas para coger el cuello de útero	906
HEYMANN Tijeras nasales	120, 156	JACOBSON Cucharillas cortantes	1091
HEYMANN-KNIGHT Pinzas para tamponamiento y pólipos nasales	670	JACOBSON Cuchillos para vasos	827, 838
HEYWOOD-SMITH Pinzas para pólipos uterinos y ovarios	357	JACOBSON Empujador de sutura	827, 828
HIBBS Cinceles	1038	JACOBSON Sonda abotonata	827, 828
HIBBS Gubias	1039	JACOBSON Sonda doble	827
HIBBS Osteótomos	1038	JAEGER Pinzas para menisco y cartilago	1145
Hilos de cerclaje	1157	JAEGER Pinzas para pasar tendones	1151
HIRSCHMANN Anoscopios	863	JAMESON Calibrador	22
HOEN Disecadores de dura-madré	551	JAMESON Porta-agujas	492
HOEN Periostótomos	1068	JAMESON SCT Tijeras des disección	189
HOEN Pinzas para laminectomía	1007	JAMESON TC Tijeras des disección	172
HOEN V. EICKEN Captador de hilos	627	JAMESON Tijeras des disección	114, 155
HOESEL Separadores	408	JANET Jeringas	75, 76
HOESEL TC Porta-agujas	530	JANSEN Cucharillas cortantes	1091, 1092
HOFF Pinzas de campo	369	JANSEN Curetas auriculares	730
HOHMANN Elevadores para huesos	1077-1079	JANSEN Lámpadas frontales	27
Hojas de afeitar	47, 1207	JANSEN Periostótomos	1060, 1064
Hojas de bisturí	48, 50	JANSEN Pinzas auriculares y nasales	222
HOKKE Osteótomos	1037	JANSEN Pinzas-gubias	1129, 1130
HOLINGER Laringoscopios para operaciones	641	JANSEN Separadores, autoestáticos	446
HOLSHER Separadores para la raíz de nervios	553	JATHO Pinzas naso-faringeas	631
HOLZBACH Pinzas haemostaticas	258	JAVID Pinzas vasculares atraumáticas	326, 327
HOLZBACH Separadores abdominales	475	JENNINGS Abrebocas	605
HOLZHEIMER Separadores, autoestáticos	445	Jeringa de laríngeos	76
HOPKINS Cuchillos para escayolas	1195	Jeringas	74-76
Horquilla	747, 752	Jeringas auriculares	719
Horquilla de hilos	513	JIKEI Pinzas nasales	759, 760
Horquilla para implantar	705	JOBSON-HORNE Porta-algodones	65
HORSLEY Separadores para la raíz de nervios	552	JOHN-HOPKINS Clamps Bulldog	292, 293
Hosterómetros	899	JOHN-HOPKINS Pinza para poner los clamps bulldog	293
HOUSE Cucharilla cortantes	751	JOHNS-HOPKINS Pinzas de disección y ligaduras	281
HOUSE Micro aguja	748	JONES Pinzas de campo	369
HOUSE Periostótomo	747	JORGENSEN Tijeras vasculares	132
HOUSE Separadores para tráquea	656	JOSEPH Cuchillos para el tabique nasal	673
HOUSE Tubos para aspiración	86	JOSEPH Cuchillos para rinoplastia	672, 673
HOUSE-DIETER Pinzas saca-bocado	742	JOSEPH Elevadores para tabique nasal	677
HOWARTH Elevadores para tabique nasal	678	JOSEPH Escofi nas nasales	1084
HUBER Mango universal	636, 923	JOSEPH Periostótomos	1053



JOSEPH SCT Tijeras finas para cirugía	190	KNIGHT Pinzas para tabique nasal	696
JOSEPH Separadores	443	KNIGHT Tijeras nasales	121
JOSEPH Sierras nasales	685	KNIGHTON Separadores para cuerpos vertebrales	593
JOSEPH TC Tijeras des disección	172	KNOWLES Tijeras para vendajes	1186
JOSEPH TC Tijeras finas para cirugía	177	KOCHER Agujas para ligaduras	502
JOSEPH Tijeras finas para cirugía	123	KOCHER Espátulas para la vesícula	953
JOSEPH-MASING Elevadores para tabique nasal	677	KOCHER Pinzas haemostaticas	254, 255
JUDD-ALLIS Pinzas intestinales y para tejidos	365	KOCHER Pinzas-clamps intestinales	846, 848
JUDD-MASSON Separadores para la vejiga	952	KOCHER Separadores	376, 392, 399, 404
Juego de autopsia	1021	KOCHER Sonda para bocio	657
Juego para diagnóstico	30-35	KOCHER-LANGENBECK Separadores	389, 390
Juego para tunelar	811	KOCHER-WAGNER Separadores	405
Juego para varices	806, 807	KOELNER Pinza haemostática para cuero cabelludo	546
JUERS Micro pinzas para plegar alambre	742	KOENIG Diapasones	714
JURASZ Pinzas naso-faringeas	631	KOENIG Elevadores	1052
JURASZ Pinzas para pólipos laríngeos	634	KOENIG Periostótomos	1053
K		KOENIG Separadores	437
KABIERSKE Pulverizadores	718	KOENIG Sondas conductoras	512
KADER Separadores	425	KOERTE Separadores	379, 424
KAHN Tijeras para Face-lift	117	KOGAN Endoespéculos	896
KALLMORGEN Espéculos vaginales	891	KONRICH Tambores para esterilización	1224
KALT Porta-agujas	497	KOOS Cuchillos para vasos	838
KANE Clamp umbilical	937	KRAEMER Periostótomos	1063
KANTROWITZ Pinzas de disección y ligaduras	266	KRAEMER Separadores	388
KARLIN-CRANK Separadores para laminectomia	588	KRAUS Cuchillos para vasos	838
KATSCH Extractore para comedones	61	KRAUSE Cánula para punción del seno maxilar	71
KATZIN Micro-tijeras	142	KRAUSE Pinzas para Broncho-esofagoscopia	637
KATZIN-BARRAQUER Micro-tijeras	142	KRAUSE Polipótomos	671
KAYE TC Tijeras para Face-lift	175	KRAUSE Polipótomos auriculares	738
KAYE Tijeras para Face-lift	118	KRAUSE-VOSS Polipótomos	671
KAYE-MILLARD Separadores	444	KRAUSE-VOSS Polipótomos auriculares	738
KELLY Esfinteroscopios	863	KRAYENBUEHL Ganchitos para nervios y vasos	829
KELLY Pinzas de disección y ligaduras	270	KRESSNER Pinzas para tabique nasal	699
KELLY Pinzas haemostaticas	249	KRISTELLER Espéculos vaginales	889-890
KELLY Pinzas para pólipos uterinos y ovarios	356	KRISTELLER WIENER Espéculos vaginales	891
KELLY SCT Tijeras finas para cirugía	190	KROENLEIN Pinzas haemostaticas	251
KELLY Separadores	406, 412, 413, 485	KRONECKER Agujas para ligaduras	502
KELLY TC Tijeras finas para cirugía	177	KUEHNE Pinzas porta-laminillas	226
KELLY Tijeras finas para cirugía	123, 156	KUEMMEL Separadores	401, 424
KELLY-RANKIN Pinzas haemostaticas	247	KUESTNER Pinzas para coger el cuello de útero	904
KELMAN-MC PHERSON Micro pinzas	227	L	
KERN-LANE Pinza para huesos	1119, 1121	LA FORCE Adenótomos	630
KERPEL Cucharillas cortantes	1114	LA GRANGE Tijera para encías	124
KERRISON Pinzas cortantes para laminectomia	958, 976, 977	LABORDE Dilatatore traqueales	654
KERSTING Pinzas para anastomosis de recto	858	LACK Abajalenguas	601
KEVORKIAN Curetas para biopsia	912	LAHEY Pinzas de disección y ligaduras	280, 281
KEVORKIAN Pinzas saca-bocados para biopsia	920, 922	LAHEY Pinzas para coger el cuello de útero	908
KEVORKIAN-PACIFIC Pinzas saca-bocados para biopsia	921	LAHEY Pinza de sugestión para bocio	657
KEY Periostótomos	1068	LAHEY Separadores	438
KEYES Trépanos para piel	60	LAMBERT-KAY Pinzas vasculares atraumáticas	330
KIELLAND Forceps obstétrico	933	LAMBOTTE Osteótomos	1034
KILLIAN Elevadores	1055	LAMBOTTE Periostótomos	1065
KILLIAN Elevadores para tabique nasal	678	LAMBOTTE Pinza para huesos	1124, 1125
KILLIAN Espéculos nasales	663-666	LAMBOTTE Separadores	378
KILLIAN Gubias	679	Lámpadas frontales	26-27
KILLIAN Periostótomos	1055	LANDAU Espéculos vaginales	893
KILLIAN Pinzas para tamponamiento y pólipos nasales	670	LANDAU Trócares	71
KILLIAN Porta-algodones	633	LANDOLT Cucharilla	706
KILLIAN Tijeras para tabique nasal	700	LANDOLT Cureta	706
KILLIAN-CLAUS Gubias	679	LANDOLT Enucleadores	706
KILLIAN-RUDERT Espéculos nasales	665	LANDOLT Gancho	706
KILNER (RAGNELL) Tijeras des disección	113, 155	LANDOLT Mangos de bisturíes	826
KILNER Ganchito para alas de nariz	688	LANDOLT Periostótomos	562
KILNER Porta-agujas	491	LANDOLT Pinza retractora para espéculos	702
KILNER Separadores	419, 439, 442	LANDOLT Pinzas cortantes para laminectomia	1005
KILNER TC Porta-agujas	525	LANDOLT Tijeras nasales	121
KILNER TC Tijeras des disección	172	LANDOLT-REULEN Cureta	708
KILNER Tijeras finas para cirugía	126	LANDOLT-REULEN Disecadores	708
KILNER-DOUGHTY Abrebocas	613	LANDOLT-REULEN Legra	708
KIRK Martillos	1017	LANDON Espéculos vaginales	892
KIRKLIN Separadores	438	LANE Elevadores para huesos	1076
KIRSCH Separadores	388	LANE Pinzas de campo	368
KIRSCHNER Estribos para extensión	1154, 1155	LANE Pinzas quirúrgicas	215
KIRSCHNER Separadores abdominales	472, 473	LANE Pinzas-clamps intestinales	853
KIRSCHNER Sondas conductoras	510, 511	LANE-TRETHOWAN Elevadores para huesos	1076
KLAPP Separadores	433	LANGE Pinzas para Broncho-esofagoscopia	637
KLEINERT-KUTZ Pinzas para pasar tendones	1152	LANGE Separadores	436
KLEINERT-KUTZ Pinzas-gubias	1127, 1132	LANGE Tijeras para vendajes	1186
KLEINERT-KUTZ Separadores	444	LANGE-HOHMANN Elevadores para huesos	1079, 1080
KLEINSCHMIDT Pinzas-clamps intestinales	852	LANGENBECK Asas auriculares	728
KLIMA-ROSEGGER Agujas para punción del esternón	73	LANGENBECK Cuchillos para amputación	52
KLINKENBERGH-LOTH Tijeras vasculares	131	LANGENBECK Cuchillos para resección	53
KNAPP Separadores	432	LANGENBECK Elevadores	1074



LANGENBECK Periostótomos	1064
LANGENBECK Pinza para huesos	1118
LANGENBECK Protección del dedo	619
LANGENBECK Separadores	381-383
LANGENBECK Sierras para amputación y resección	1010
LANGENBECK TC Porta-agujas	531
LANGENBECK-RYDER TC Porta-agujas	534
LANGE-WILDE Polipótomos	671
LANGE-WILDE Polipótomos auriculares	738
LANG-STEVENSON Pinzas-clamps intestinales	852
Laringología	652, 653
Laringoscopios de luz fría y accesorios	40-41, 43
Laringoscopios para operaciones	638-641
Laringoscopios y accesorios	36-43
LAWRENCE Pinzas de disección y ligaduras	264
LEBSCHKE Cíncel para esternón	764
LEBSCHKE Conductor para sierras de hilo	549
LEES Pinzas vasculares atraumáticas	314, 323
Legra	704, 708, 752, 831, 832, 835
LEGUEU Espátulas para la vesícula	953
LEGUEU Separadores para la vejiga	952
LEKSELL Pinzas-gubias	1137
LEKSELL-STILLE Pinzas-gubias	1137
LELAND-JONES Pinzas vasculares atraumáticas	317-319
LEMPERT Cucharillas cortantes	1098
LEMPERT Elevadores	737
LEMPERT Periostótomos	1054
LEMPERT Tubos para aspiración	80
LERCHE Pinzas quirúrgicas	218
LERICHE Pinzas haemostáticas	247, 257
LERICHE Separadores	423
LEWIN Pinzas para reducción	1116
LEWIS Escofi nas nasales	1084
LEWKOWITZ Pinzas para cálculos	945
LEXER Cinceles	1042
LEXER Gubias	1043, 1044, 1048
LEXER Gubias de esponjosa	1045, 1048
LEXER Osteotomos	1043, 1047
LEXER SCT Tijeras des disección	188
LEXER TC Tijeras des disección	171
LEXER Tijeras des disección	112, 155
LEXER-BABY Tijeras des disección	112
LEXER-MINI Gubias	1041
LEXER-MINI Osteotomos	1041
LEYLA Separadores para la fijación del cráneo	540-542
LICHTENBERG Porta-agujas	497
LICHTENBERG TC Porta-agujas	530
LICHTWITZ Cánula para punción del seno maxilar	70, 87
Ligadores hemorroides	866-868
Limas para uñas	1206
LISTER Bujías dilatadoras	950
LISTER Pinzas para vendajes	352
LISTER Tijeras para vendajes	1187
LISTER Tijeras para vendajes y Cizallas para escayolas	1190
LISTON Cuchillos para amputación	52
LISTON Pinzas cortantes para huesos	1141-1143
LISTON-KEY Pinzas cortantes para huesos	1144
LISTON-STILLE Pinzas cortantes para huesos	1143
LITTAUER Pinzas depilatorias	223
LITTAUER Pinzas para pólipos auriculares	732
LITTAUER Pinzas para tamponamiento y pólipos nasales	670
LITTAUER Tijeras para ligatures	147
LITTLE Separadores	438
LITTLER Tijeras finas para cirugía	126
LITTLER Tijeras para ligatures	147
LITTLEWOOD Pinzas intestinales y para tejidos	365
LLOYD-DAVIES Tijeras rectales	106
LLOYD-DAVIES Pinzas para anastomosis de recto	856
LOCKHART-MUMMERY Sondas	64
LOCKLIN TC Tijeras para encías	178
LOCKLIN Tijeras vasculares	133
LOCKWOOD Pinzas intestinales y para tejidos	362
LOCKWOOD-ALLIS Pinzas intestinales y para tejidos	365
LOPEZ-REINKE Disectores para amígdalas	622
LORENZ Tijeras para vendajes y Cizallas para escayolas	1190
LORNA (EDNA) Pinzas de campo	369
LOUTE Instrumentos para cerclaje	1158
LOVE Separador para velo del paladar	627
LOVE Separadores para la raíz de nervios	551, 552, 553
LOVE-GRUENWALD Pinzas cortantes para laminectomía	996
LOVELACE Pinzas para coger el pulmón	801
LOWER Pinzas de disección y ligaduras	281
LOWMAN Pinzas porta-huesos	1126

LOWMAN-HOGLUND Pinzas porta-huesos	1126
LUBET-BARBON Pinzas para tamponamiento y pólipos nasales	669
LUC Pinzas para tabique nasal	697
LUCAE Agujas para paracentesis	737
LUCAE Diapasónes	713, 714
LUCAE Martillos	1016
LUCAE Pinzas auriculares y nasales	221, 222
LUCAE Separadores	429
LUCAS Cucharillas cortantes	1091
LUER Cánulas traqueales	654
LUER Jeringas	74
LUER Pinzas intestinales y para tejidos	366
LUER Pinzas-gubias	1128, 1130
LUER Separadores	419
LUER-FRIEDMANN Pinzas-gubias	1127
LUER-KOERTE Cucharas para cálculos biliares	873
LUER-LOCK Jeringas	74, 76
LUER-STILLE Pinzas-gubias	1138, 1139
LUIKART-BILL Cierre de la pinza	936
LUKENS Separadores para tráquea	656
LUNIATSCHEK Taponador	626
Lupas	23
Lupas auriculares	726, 727
LURZ Pinzas para los cálculos biliares	877
M	
M. G. HOSPITAL Porta-agujas	489
MAGILL Pinzas para introducir catéteres	944
MAGILL Tubos para aspiración	79
MAINGOTT Pinzas-Clamps para histerectomía	275
Malla de alambre	1155
MALTZ Escofi nas nasales	1085, 1087
Mango con gancho, para sierras de hilo	1010
Mango de pila del Laringoscopios	42-43
Mango para aspiración	85
Mango universal	636, 923
Mangos de bisturíes	44-47, 50, 823, 825, 826
MANNERFELT Gubias	1181
MANNERFELT Osteotomos	1181
MANNERFELT Periostótomos	1180, 1181
MANNERFELT Separadores	1178-1180
Manómetros para la presión de la sangre	24-25
Manoplas de plomo	1182
Marcadores para aréola	21
MARKWALDER Pinzas-gubias	1139
MARQUARDT Pinzas-gubias	1133
MARSCHIK Pinzas para amígdalas	620
MARSCHIK-KRONE Pinzas para amígdalas	621
Martillos	751, 1013-1020
Martillos para reflejos	16, 17
MARTIN Cuchillos para escayolas	1195
MARTIN Hosterómetros	899
MARTIN Pelvímeter	931
MARTIN Pinzas para desechos	1218
MARTIN Pinzas para menisco y cartilago	1146
MARTIN Pinzas para vendajes	351
MARTIN Porta-algodones	65
MARTIN Separadores	375, 377, 414
MARTIN Sierras para abrir anillos	1011
MARTIN Tijeras para cartilago	116
MARTIN-CUSHING Periostótomos	1071
MARTINI Cucharillas cortantes	1091
MARTIN-LANGENBECK Periostótomos	1071
MASING Cuchillos para rajar cartílagos	672
MASING Elevadores para tabique nasal	677
MASING Pinzas auriculares	734
MASING Separadores nasales	690
MASSON Porta-agujas	493
MASSON TC Porta-agujas	527
MASSON-LUETHY Porta-agujas	494
MASTIN Pinza-clamp para músculos	657
MATHIEU Espéculos vaginales	892
MATHIEU Pinzas para cuerpos extraños	948
MATHIEU Porta-agujas	496
MATHIEU Separadores	418
MATHIEU Separadores para el recto	861
MATHIEU TC Porta-agujas	528, 529
MATHIEU-RYDER TC Porta-agujas	534
MATZENAUER Espéculos vaginales	892
MAUNDER Tornillo oral	619
MAXIMUS Manómetros para la presión de la sangre	24
MAYFIELD Pinzas-gubias	1132
MAYO Cucharas para cálculos biliares	874
MAYO Espátulas linguales	600



MAYO Imperdibles para instrumentos	372	MICRO-RYDER TC Porta-agujas	532
MAYO SCT Tijeras para cirugía	186	Micro-tijeras	138-143
MAYO TC Tijeras para cirugía	165	Micro-tijeras de agarre	644, 646, 651
MAYO TC Tijeras para ligatures	181	MICRO-VASCULAR TC Porta-agujas	532
MAYO Tijeras para cirugía	103, 152	MIDDELDORPF Separadores	400
MAYO-ADAMS Separadores, autoestáticos	449	MIDDLETON-JANSEN Pinzas para tabique nasal	699
MAYO-BLAKE Pinzas para los cálculos biliares	877	MIKULICZ Pinzas para peritoneo	277-279
MAYO-GUYON Pinzas para pedículo renal	285	MIKULICZ Separadores	392, 393
MAYO-HARRINGTON SCT Tijeras para cirugía	186	MILAN Curetas para biopsia	914
MAYO-HARRINGTON TC Tijeras para cirugía	165	MILIGAN Separadores, autoestáticos	449
MAYO-HARRINGTON Tijeras para cirugía	105, 153	MILLARD (COTTLE) Gancho en forma de anillo	689
MAYO-HEGAR Porta-agujas	488, 489	MILLER Cucharillas cortantes	1092
MAYO-HEGAR TC Porta-agujas	521	MILLER Escofi nas nasales	1087
MAYO-LEXER TC Tijeras des disección	171	MILLER Laringoscopios	37
MAYO-NOBLE Tijeras para cirugía	105	MILLER Laringoscopios de luz fría	41
MAYO-ROBSON Pinzas-clamps intestinales	850	MILLER-COLBURN Cucharillas cortantes	1094
MAYO-RUSSIAN Pinzas para agrar tejidos	203	MILLER-COLBURN Escofi nas nasales	1088
MAYO-STILLE SCT Tijeras para cirugía	187	MILLIGAN Disecadores de dura-madré	550
MAYO-STILLE TC Tijeras para cirugía	167	MILLIN Dilatador para el cuello vesical	953
MAYO-STILLE Tijeras para cirugía	104, 153	MILLIN Pinzas capsulares	955
MC CLINTOCK Pinzas para aborta y placenta	940	MILLIN Separadores para la vejiga	952
MC CLURE Micro-tijeras	138	MILLS Tijeras vasculares	137
MC CULLOCH Seperadores para laminectomia	586,587	MINI-HOHMANN Elevadores para huesos	1075
MC DONALD Periostótomos	1055	MINI-LAMBOTTE Osteótomos	1030, 1031
MC GEE Gancho	750	MINI-LANGENBECK Separadores	439
MC GEE Micro pinzas para plegar alambre	741, 744	MINIMUS Manómetros para la presión de la sangre	24
MC GIVNEY Ligadores hemorroides	868	MINI-OLSEN Porta-agujas con tijeras	495
MC GLAMRY Periostótomos	1068	MINI-ROUX Separadores	417
MC INDOE Osteótomos	684	MINI-TOWNSEND Pinzas saca-bocados para biopsia	922
MC INDOE Pinzas de disección	199	Mini-Transformador	27
MC INDOE Pinzas quirúrgicas	211	MINI-VANNAS Micro-tijeras	138
MC INDOE Separadores	443	Miringotomo	735
MC INDOE TC Pinzas de disección	232	MISKIOM Separadores, autoestáticos	454
MC INDOE Tijeras para cartílago	115	MIXTER Pinzas de disección y ligaduras	268, 280
MC INTOSH Laringoscopios	38	MIXTER Pinzas para los cálculos biliares	878
MC INTOSH Laringoscopios de luz fría	40	MIXTER Tijeras para cirugía	97
MC IVOR Abajalenguas	616	MIXTER-O'SHAUGNESSY Pinzas de disección y ligaduras	281
MC IVOR Abrebocas	614	MOCK Aguja para heparin	73
MC KENTY Elevadores para tabique nasal	676, 677	MOELTGENGoniómetro	20
MC KENZIE Grapas de plata	546	MOLDENHAUER Elevador auricular	730
MC KENZIE Pinzas aplicadoras para agrafes	547	MOLDESTAD Separadores	433
MC KENZIE Porta-rapas	546	MOLLISON Separadores, autoestáticos	447
MC KESSON Tornillo oral	619	MOLT Abrebocas	603
MC QUIGG-MIXTER Pinzas vasculares atraumáticas	300	MOLT Periostótomos	1054
MEAD Martillos	1013	Mondador de tendónes	1152, 1153
MEAD Pinzas-gubias	1130	MOORE Cucharilla para la vesícula biliar	873
Measuring tape	21	MOORE Perforadores de mano	1171
Meatótomo	948	MOORFIELD Pinza para sutura	198
MEEKER Pinzas de disección y ligaduras	266	MORGAN Proctoscopios	864
MEMORY Espátulas cerebrales	544	MORITZ-SCHMIDT Abajalenguas	601
MENGHINI Aguja para la punción ciega del hígado	74	MORRIS Separadores	401
MERCEDES Separadores costales	790	MORRIS-DE BAKEY Pinzas vasculares atraumáticas	324
METZENBAUM Porta-agujas	489	MORSE Separadores costales	775, 778, 779
METZENBAUM SCT Tijeras des disección	187, 188	MORSE-FAVALORO Separadores costales	778
METZENBAUM TC Tijeras des disección	167-170	MOSHER-BRUENINGS Tubo del intubation	653
METZENBAUM TC Tijeras para ligatures	181	MOSQUITO-DANDY Pinzas haemostaticas	248
METZENBAUM Tijeras des disección	108-111, 154	MOYNIHAN Pinzas-Clamps para histerectomia	273
METZENBAUM-BABY Tijeras des disección	111, 155	MOYNIHAN Sondas exploradoras para cálculos biliares	872
METZENBAUM-LAHEY TC Tijeras des disección	173	MUCK Cuchillo para peristio	735
MEYER Pinzas para reducción	1116	MUEHLING Periostótomos	562
MEYERDING Separadores	407, 441, 486	MUELLER Pinzas para anastomosis de recto	858
MEYERDING Separadores, autoestáticos	452	MUELLER Separadores, autoestáticos	445
MICHEL Agrafes de sutura	516	MUENCHEN Curetas para biopsia	913
MICHEL Espejos para rinoscopia	632	MURPHY Cinta de celuloide	35
MICHEL Pinzas aplicadoras para agrafes	517	MURPHY-LANE Elevador para luxación	1083
MICK Tijeras para vendajes y Cizallas para escayolas	83, 109	MUSEUX Pinzas para coger el cuello de útero	905, 906, 908
Micro agujas	748, 749, 752, 753	MUSGROVE Aguja de cerumen y aplicadores de algodón	730
Micro cuchillos	745	MYLES Pinzas nasales	990
Micro disecador	814	N	
Micro ganditos	749	NABATOFF Juego para varices	806
Micro instrumentos	745-753	NAEGELE Forceps obstérico	932
Micro pinzas	226-228	NAGER Separador para velo del paladar	627
Micro pinzas auriculares	739, 743	Navajas	58
Micro pinzas de copas	739, 743	NEFF Bisturries para menisco	1146
Micro pinzas para plegar alambre	741, 742, 744	NEGUS (GUEDEL) Laringoscopios	36
Micro tijeras auriculares	740, 744	NEGUS Cuchillos para adenoides	629
MICRO-ADSON Pinzas haemostaticas	245	NEGUS Pinzas para pedículo renal	282
Microcirugía endolaríngeal	642-651	NEGUS Sopoite de pecho para todos los abrebocas	617
Microdisectomia lumbar separador Set	583	NEIVERT Gancho para alas de nariz	690
MICRO-MOSQUITO Pinzas haemostaticas	250, 259	NEIVERT Porta-agujas	491
Micro-pinza de agarre	642-643, 646, 649-651	NEIVERT-ANDERSON Osteótomos	683
Micro-pinza en forma de cucharilla	642, 647-651	NEIVERT-MASING TC Porta-agujas	524
Micro-porta-aguja	643, 644	NÉLATON Sondas acanaladas	63



NELSON Pinzas para agrrar pulmón	216	PAYR Sondas conductoras	512
NELSON Trócares	69	PEAN Pinzas haemostaticas	238-241
Neurocirugía	537-594	PECK-JOSEPH Tijeras finas para cirugía	123
NEW ORLEANS TC Porta-agujas	526	PEDERSON Espéculos vaginales	883, 884
NEWS Separadores para tráquea	656	PEERS-BERTRAM Pinzas de campo	369
NICOLA Cureta	704	PEET Pinzas para espinas	1208
NICOLA Legra	704	PELKMANN Pinzas para vendajes	355
NICOLA Micro-pinza en forma de cucharilla	651	PELTESON Porta-algodones	633
NICOLA Micro-tijeras de agarre	651	Pelvímetro	931
NIEDERDELLMANN Osteótomos	1038	PENFIELD Disecadores para duramadre	812
NISSEN Pinzas haemostaticas	243	PENNINGTON Elevadores para tabique nasal	676
NORFOLK & NORWICH Separadores, autoestáticos	453	PENNINGTON Pinzas intestinales y para tejidos	362
NOTO Pinzas para pólipos uterinos y ovarios	357	PENNYBACKER Pinzas cortantes para laminectomía	1004
NOTT Espéculos vaginales	883	PENNYBACKER Pinzas-gubias	1131
NOVAK Curetas para biopsia	912	PENNYBAKER Disecadores para duramadre	813
NOYES Micro-tijeras	140	PERCY Retractores para amputación	1008
NUBOER Tubos para aspiración	78	Perfora-cráneos	937
NUSSBAUM Pinzas-clamps intestinales	849	Perforadores	748
O		Perforadores de mano	1156, 1157, 1171-1173
O'BRIEN Tijeras finas para cirugía	128	Perforadores para aorta	811
OBWEGESER Agujas para ligaduras	501	Periostótomos	562, 563, 1052-1055, 1058-1071
OBWEGESER Elevadores	1056	PERKINS Separadores, autoestáticos	448
OBWEGESER Escofinas	1088	PERTHES Escariadores	1012
OBWEGESER Gancho de mentón	383, 1057	PESTALOZZA Cucharillas para aborta y placenta	942
OBWEGESER Osteótomos	1035, 1036	PETZ Pinzas-clamps intestinales y estomacales	860
OBWEGESER Osteótomos de cuña	1035	PHANEUF Pinzas-Clamps para histerectomía	273
OBWEGESER Osteotómos de hoja	1035	Piedra afilador	58
OBWEGESER Osteotómos hendedores	1035	PIERCE Cánula para punción del seno maxilar	70
OBWEGESER Osteotómos interdentes	1036	PIERCE Elevadores para tabique nasal	676
OBWEGESER Periostótomos	1058, 1059	Pies de rey para	559
OBWEGESER Separador para muela del juicio	387	PINARD Estetoscopios fetales	17
OBWEGESER Separadores para el ramo	386	Pinzas de tracción craneal	548
OBWEGESER Separadores para partes blandes	384, 385	Pinzas de vena cava	347, 348
OBWEGESER Separadores mandibulares	1057	Pinza de fijacion	686
OCHSNER Pinzas de disección	203	Pinza de introducción de la lámina auricular	820
OCHSNER Pinzas vasculares atraumáticas	331	Pinza para abscesos de las amígdalas	623
OCHSNER Sondas exploradoras para cálculos biliares	873	Pinza para agrrar	204
OCHSNER Trócares para vesícula biliar	71	Pinza para cerrar clamps	860
OCHSNER-KOCHER Pinzas haemostaticas	252, 253	Pinza para cerrar los clamps	845
O'CONNOR Separadores	431	Pinza para coger la piel	686
OKONEK-YASARGIL Empujador de tumor	828	Pinza para columela	686
OLDBERG Pinzas cortantes para laminectomía	1005	Pinza para cuerpos extraños	731
OLIVECRONA Bisturíes para nervio trógemino	57	Pinza para fijar	946
OLIVECRONA Disecadores de dura-madre	550	Pinza para formar huesos	1118
OLIVECRONA Espátulas cerebrales	544	Pinza para huesos	1117-1125
OLIVECRONA Pinzas-gubias	1131	Pinza para introducir para prótesis de teflon	742
OLIVECRONA Sierras de hilo	1010	Pinza para pericráneo	936
OLIVECRONA Tijeras nasales	120	Pinza para poner los clamps bulldog	293, 296
OLIVECRONA-TOENNIS Pinzas aplicadoras para agrafes	547	Pinza para rotula	1117
OLLIER Separadores	380	Pinza para sutura	198
OLSEN-HEGAR Porta-agujas con tijeras	495	Pinza retractora para espéculos	702
OLSEN-HEGAR TC Porta-agujas	527	Pinza-clamp para músculos	657
OMBREDANNE Martillos	1015	Pinza-clamp uterina	936
Orinal	1216	Pinza-guía para taladros	1012
O'SHAUGNESSY Pinzas de disección y ligaduras	281	Pinzas	194-229
Osteótomos	680-684, 1021, 1026-1051	Pinzas aplicadoras para agrafes	517, 518
Osteotómos de cuña	1035	Pinzas atrauma	218-220
Osteotómos de hoja	1035	Pinzas auriculares	732-734
Osteotómos hendedores	1035	Pinzas auriculares y nasales	221, 222
Osteotómos interdentes	1036	Pinzas bronquiales	802
O'SULLIVAN - O'CONNOR Espéculos vaginales	895	Pinzas capsulares	955
O'SULLIVAN-O'CONNOR Separadores abdominales	476	Pinzas con bocas de carburo tungsteno	232-236
OTIS Uretrótomo	954	Pinzas cortantes circulares	756
Otoscopios	599, 712	Pinzas cortantes para huesos	1141-1144
OVERHOLT Pinzas de disección y ligaduras	261, 262	Pinzas cortantes para laminectomía	958-978, 984, 985, 979-987, 994-1007
OVERHOLT-GEISSENDOERFER Pinzas de disección y ligaduras	260	Pinzas cortantes para laminectomía, desmontable	962, 966
OVERHOLT-MIXTER Pinzas de disección y ligaduras	268	Pinzas de campo	367-369
P		Pinzas de disección	194-204
PACHON Manómetros para la presión de la sangre	24	Pinzas de disección y ligaduras	260-270, 280-281
PAPAVERO-CASPAR Espéculos para hipofí sectomía	702	Pinzas de relojero	228
PARKER Separadores	417	Pinzas depilatorias	223
PARKER-BABY Separadores	417	Pinzas garrapata	226
PARKER-KERR Pinzas para anastomosis de recto	855	Pinzas haemostaticas	238-260
PARKER-LANGENBECK Separadores	418	Pinzas intestinales y para tejidos	360-366
PARKER-MOTT Separadores	418	Pinzas nasales	756-760, 988-994
PARKS Escofi nas nasales	1087	Pinzas nasales para biopsia	755
PARTSCH Cinceles	1027	Pinzas naso-faringeas	631
PARTSCH Gubias	1028	Pinzas para aborta y placenta	939-941
PARTSCH Martillos	1017	Pinzas para agrrar pulmón	216
PARTSCH-LANGE Periostótomos	1052	Pinzas para agrrar tejidos	203, 204, 209, 217
PASSOW Pisón	1024	Pinzas para amígdalas	620
PAUL Separadores	444	Pinzas para anastomosis de recto	855-859
PAYR Pinzas-clamps intestinales	854		

Pinzas para biopsia rectal	869	Porta-agujas con bocas de carburo tungsteno	520-535
Pinzas para Broncho-esofagoscopia	636	Porta-agujas con tijeras	495
Pinzas para cálculos	945	Porta-algodones	65, 66, 633, 653
Pinzas para coger el cuello de útero	901-908	Porta-clamp	845
Pinzas para coger el pulmón	801	Porta-hojas	47
Pinzas para cortar uñas	1205, 1206	Porta-rapas	546
Pinzas para cuerpos extraños	948	Portas ligaduras	815, 822
Pinzas para desechos	1218	POTTS Pinzas vasculares atraumáticas	307, 308, 315, 319, 320
Pinzas para el maleolo	1117	POTTS-DE MARTEL SCT Tijeras vasculares	192
Pinzas para el seno frontal	695	POTTS-DE MARTEL Tijeras vasculares	136
Pinzas para el útero	909, 910	POTTS-SMITH Pinzas de disección	201
Pinzas para el vómer	696, 697	POTTS-SMITH Pinzas quirúrgicas	213
Pinzas para entrelazar tendones	1150-1152	POTTS-SMITH TC Pinzas de disección	233
Pinzas para espinas	224-225, 1208	POTTS-SMITH TC Tijeras vasculares	179
Pinzas para esterilización	1209	POTTS-SMITH Tijeras vasculares	117, 133, 136, 158
Pinzas para etmoides	745	POZZI Pinzas para coger el cuello de útero	902
Pinzas para extraer alambres	1159-1163	PRATT Curetas para el seno maxilar	690
Pinzas para introducir catéteres	944	PRATT Pinzas para coger el cuello de útero	907
Pinzas para iridectomía	197, 208	PRATT Pinzas para peritoneo	277
Pinzas para los cálculos biliares	877, 878	PRATT Separadores para el recto	861
Pinzas para los cálculos renales	875	PRATT Sondas	64
Pinzas para menisco y cartilago	1145, 1146	PRECISA Manómetros para la presión de la sangre	24
Pinzas para nefrostomía	874, 876	PRINCE Tijeras para amígdalas	116
Pinzas para pasar tendones	1150-1152	PRINCE-THOMAS Pinzas bronquiales	802
Pinzas para pediculo renal	282-284	PRINCE-THOMAS Pinzas para coger el pulmón	801
Pinzas para peritoneo	277-279	Proctoscopios	862, 864
Pinzas para pólipos auriculares	732	Protección del dedo	619
Pinzas para pólipos laríngeos	634, 635	PROVIDENCE-HOSPITAL Pinzas haemostaticas	249
Pinzas para pólipos uterinos y ovarios	356, 357	Pulverizadores	718
Pinzas para poner agrafes ETHICON	518	Puntas de prueba rectales	866
Pinzas para reducción	1115	PUTTI Escofinas	1089
Pinzas para sacar órganos	358	Q	
Pinzas para secuestro	1118	QUATTRO Separadores para escayolas	1194
Pinzas para sujetar y romper hojas de afeitar	825	QUERVAIN Elevadores	1074
Pinzas para tabique nasal	696-699, 701	QUINBY Tijera para encías	124
Pinzas para tamponamiento y pólipos nasales	669, 670	QUINKE Agujas para la punción ciega del hígado	74
Pinzas para tampones	353, 359, 349-352, 354, 355	QUIRE Elevador para cuerpos extraños	731
Pinzas para tubos	370-371	Quita hojas	48
Pinzas para uréter	945	R	
Pinzas para vasos y tumores	214, 216, 218	RABINER Martillo para reflejos	17
Pinzas para vendajes	349-352, 354, 355	Rack para instrumentos Rhoton	839
Pinzas porta-huesos	1126	RADOLF Pinzas para cortar uñas	1206
Pinzas porta-laminillas	226	RAGNELL Separadores	419
Pinzas quirúrgicas	205-218	RAGNELL-DAVIS Separadores	440
Pinzas saca-bocado	742, 744	RAKE Separadores	486
Pinzas saca-bocado craneal	549	RALK Perforadores de mano	1172, 1173
Pinzas saca-bocados para biopsia	916-923	RALK Pinzas para espinas	1208
Pinzas saca-bocados para el seno maxilar	693-695	RAMPLEY Pinzas para tampones	359
Pinzas tira-lengua	618	RANDALL Curetas para biopsia	912
Pinzas vasculares atraumáticas	299-346	RANDALL Pinzas para los cálculos renales	875
Pinzas vasculares para recién nacidos	298-299	RANDALL Pinzas para nefrostomía	876
Pinzas-clamps anastomosis	845	RANEY Pinza haemostática para cuero cabelludo	546
Pinzas-clamps estomacales	851	RANEY Pinzas aplicadoras para agrafes	546
Pinzas-clamps intestinales	844-854	Rascador para lupus	60
Pinzas-clamps intestinales y estomacales	860	Raspador	748
Pinzas-Clamps para histerectomía	271-276, 286	RAY Cureta	703
Pinzas-gubias	1126-1140	RECAMIER Curetas uterinas	925, 926, 928
Pinze de sugestión para bocio	657	Recipientes	1212-1217
PIPER Forceps obstétrico	934	REDON Agujas de guía	66-68
Pisón	1024	Regla de la sutura	823
Pistola-lavatoria de chorro de agua	1226	Reglas	22
PITHA Pinzas para vendajes	352	REICHERT Depresor para epiglotis	633
PITHA Tornillo oral	619	REILL Alicates corta-alambres	1164
Placa para extender la piel	59	REILL Pinzas para reducción	1116
PLESTER Cuchillo en forma de hoz	745	REINER Cuchillos para escayolas	1195
PLESTER Cuchillo para lóbulos	745	RESANO Pinzas para anastomosis de recto	859
PLESTER Excavador	747	RESANO Tijeras de cápsula	105
PLESTER Ganchito	747	Retractores de huesos y articulaciones	1184
PLESTER Ganchito para el seno maxilar	747, 748	Retractores epicárdicos	817
PLESTER Horquilla	747	Retractores para amputación	1008
PLESTER Raspador	748	Retractores vasculares	827
PLESTER Separadores, autoestáticos	448	REVERDIN Agujas para ligaduras	500
PLESTER Tubos para aspiración	77	REVERDIN Espátulas abdominales e intestinales	421
Polipótomos	671	REYNOLDS SCT Tijeras des disección	189
Polipótomos auriculares	738	REYNOLDS TC Tijeras des disección	172, 173
POLITZER Agujas para paracentesis	736	REYNOLDS Tijeras des disección	114, 156
POLITZER Cuchillo para furúnculo	735	RHOTON Aguja	841
POLITZER Espéculos auriculares	721	RHOTON Cucharilla	840, 841
POLITZER Insufladores de aire	716, 717	RHOTON Disecador	840
POLLOSON Separadores	410	RHOTON Disector esférico	840
POOLE Tubos para aspiración	82, 83	RHOTON Elevadores	840
POPLITEA Separadores abdominales	465	RHOTON Gancho	841
Porta-agujas	488-499	RIBBON-IRIS Tijeras finas para cirugía	130



RIBBON-STEVENS Tijeras finas para cirugía	130	SCALP-CONTOUR Separadores, autoestáticos	446
RICARD Separadores abdominales	468	SCHAEDEL Pinzas de campo	368
RICHARDSON Separadores	412	SCHAMBERG Extractore para comedones	61
RICHARDSON-EASTMAN Separadores	411	SCHAEDE Cucharillas cortantes	1095
RICHAU-HOLMGREN Espéculos auriculares	726	SCHEIBE Pinzas intestinales y para tejidos	362
RICHTER Tijeras para cirugía	97	SCHHEINMANN Pinzas para Broncho-esofagoscopia	637
RICHTER-HEATH Pinzas aplicadoras para agrafas	518	SCHERBACK Espéculos vaginales	894
RIENHOFF Separadores costales	782	SCHIMMELBUSCH Tambores para esterilización	1224
RIGBY Separadores, autoestáticos	458	SCHINDLER Pinzas para peritoneo	279
RING Abajalenguas	616	SCHINK Dermátomos	59
Riñoneras	1212	SCHINK Placa para extender la piel	59
RI-RAP Estetoscopios	19	SCHIOETZ Tonómetros	23
RITTER Dilatadores para el seno frontal	753	SCHLESINGER Pinzas cortantes para laminectomía	1006
ROBB Disecadores vasculares	814	SCHMEDEN Pinzas nasales	992
ROBERTS Pinzas de disección y ligaduras	269	SCHMID Cánulas para irrigación vascular	73
ROBIN MASSE Separadores abdominales	465	SCHMID Espátula para íntima	813
ROBIN Pinzas de campo	367	SCHMIEDEN Agujas para ligaduras	502
ROCHARD Separadores abdominales	477	SCHMIEDEN Sondas conductoras	511
ROCHESTER-CARMALT Pinzas haemostaticas	245	SCHMIEDEN-DICK Agujas para ligaduras	501
ROEDER Cierra-nudos para amígdalas	627	SCHMIEDEN-PAYR Sondas conductoras	511
ROEDER Pinzas de campo	368	SCHMIEDEN-TAYLOR Tijeras vasculares	133
ROETTGEN-RUSKIN Pinzas-gubias	1134	SCHNEIDER Periostótomos	1064
ROGER Elevadores para tabique nasal	676	SCHNEIDER-SAUERBRUCH Periostótomos	1065
ROGERS Pinzas-Clamps para histerectomía	275, 276	SCHNIDT Pinzas haemostaticas	244
ROGGE Pinzas para esterilización	1209	SCHNIDT Pinzas para amígdalas	620
ROLLET Separadores	432	SCHOEMAKER Pinzas-clamps intestinales	852
Rompe-hojas de afeitar	47	SCHOEMAKER-LOTH Tijeras para ligatures	147
ROSCHKE Separadores para el recto	864	SCHOENBORN Separadores para tráquea	656
ROSE Separadores	419	SCHROEDER Bisturíes para fistulas	56
ROSEN Cucharilla	747	SCHROEDER Cucharillas uterinas	924
ROSEN Cuchillo lanceolado	747	SCHROEDER Pinzas para coger el cuello de útero	901, 903, 907
ROSEN Cuchillos para cortes redondos	746	SCHUBERT Pinzas saca-bocados para biopsia	916, 917
ROSEN Gancho	747	SCHUHKNIGHT Aparato de doblar para moldear prótesis metálicas	686
ROSEN Micro aguja	748, 749	SCHUHKNIGHT Tubos para aspiración	89
ROSEN Periostótomo	747	SCHUHKNIGHT Cuchillo en forma de hoz	746
ROSEN Tubos para aspiración	85	SCHUHKNIGHT Cuchillo en forma de rollo	746
ROSER-KOENIG Abre bocas	604	SCHUHKNIGHT Micro pinzas para plegar alambre	741
ROSS Separadores para aorta	816	SCHUL Separadores para disco intervertebral	594
ROUX Separadores	416	SCHULTZE Salpingógrafo	915
ROUX-MAGNUS Separadores	417	SCHUMACHER Costótomos	764
RUBIN Osteótomos	681	SCHUMACHER Pinzas para Broncho-esofagoscopia	637
RUBIN Pinzas para tabique nasal	701	SCHUMACHER Pinzas saca-bocados para biopsia	920
RUDD Ligadores hemorroides	867	SCHUMACHER Tijera umbilicales	102
RUMEL Pinzas de disección y ligaduras	267	SCHUMACHER-VAN DOREN Pinzas saca-bocados para biopsia	918
RUMEL-BELMONT Instrumentos para varices	815	SCHWEDEN Cucharillas cortantes	1091
RUMEL-BELMONT Portas ligatures	815	SCOVILLE Cucharillas cortantes	1106
RUSKIN Cánula para punción del seno maxilar	87	SCOVILLE Separadores	486
RUSKIN Pinzas-gubias	1133	SCOVILLE Separadores para la raíz de nervios	552
RUSKIN-LISTON Pinzas cortantes para huesos	1142	SCOVILLE Separadores para laminectomía	558
RUSSEL-DAVIS Abajalenguas	615	SCOVILLE Valvas laterales	557, 558
RUSSIAN Pinzas para agrar tejidos	203	SCOVILLE-HAVERFIELD Separadores para laminectomía	557
RUST Sierras para amputación y resección	1009	SCOVILLE-RICHTER Separadores para laminectomía	556
RYDEL-SEIFFER Diapasónes	713	SCOVILLE-RICHTER Valvas laterales	565
RYDER Porta-agujas	498	SCT Tijeras des disección	187
RYDER-VASCULAR TC Porta-agujas	532	SCT Tijeras finas para cirugía	190
S		SCT Tijeras nasales	189, 190
SAALFELD Extractore para comedones	61	SCT Tijeras para cirugía	186, 187
SACHS Disecadores de dura-madré	550, 551	SCT Tijeras para Face-lift	190
SACHS Ganchos para dura-madré	554	SCT Tijeras uterinas	186
SACHSE Meatótomo	948	SCT Tijeras vasculares	191
SAENGER Pinzas para aborta y placenta	941	SCUDDER Pinzas-clamps estomacales	851
SALENIUS Bisturíes para menisco	1146	SEBILÉAU Elevadores	1074
Salpingógrafo	915	SEDILLOT Periostótomos	1063
SALYER Tijeras para Face-lift	118	SEEMANN-SEIFERT Abre bocas	605
SAMII Bisturí de lanceta	837	SEGOND Bisturí para fibroma	56
SAMII Cuchillo del tumor	836, 837	SEGOND-LANDAU Pinzas-Clamps para histerectomía	273
SANTULLI Clamps Bulldog	296	SEIDL Espéculos vaginales	887
SANVENERO Tijeras finas para cirugía	124	SEIFFERT Pinzas para Broncho-esofagoscopia	637
SAROT Pinzas de disección y ligaduras	267	SELDIN Periostótomos	1064
SAROT Porta-agujas	490	SELLHEIM Seperador obstétrica	936
SAROT TC Porta-agujas	524	SELLORS Aproximadores para costillas	800
SATINSKY Pinzas de vena cava	347, 348	SELMANN Pinza para agrar	204
SATINSKY Pinzas vasculares atraumáticas	332	SELVERSTONE Pinzas cortantes para laminectomía	998, 999
SATINSKY Tijeras vasculares	131	SEMB Periostótomos	1066
SATTERLEE Sierras para amputación y resección	1010	SEMB Pinza para huesos	1119
SAUERBRUCH Costótomos	765	SEMB Pinzas bronquiales	802
SAUERBRUCH Estuches para agujas	1223	SEMB Pinzas cortantes para huesos	1144
SAUERBRUCH Pinzas para desechos	1218	SEMB Pinzas-gubias	1139
SAUERBRUCH Separadores	382, 394	SEMKEN Pinzas de disección	199, 200
SAUERBRUCH-CORYLLOS Pinzas-gubias	1140	SEMKEN Pinzas quirúrgicas	208, 212
SAUERBRUCH-FREY Costótomos	767	SEMKEN TC Pinzas de disección	232
SAUNDERS Instrumento para remoer dispositivo tintrauterino	911	SEMKEN TC Pinzas quirúrgicas	234, 235
SAWTELL Pinzas para amígdalas	620	SEMM Espéculos vaginales	882



SEMM Separadores abdominales	474	SLUDER-BALLENGER Amigdalotomos	625
SENN-GREEN Separadores	438	SMELLIE Ganchos para decapitación	937
SENNING TC Porta-agujas	523	SMELLIE Perfora-cráneos	937
SENN-MILLER Separadores	439	SMILLIE Bisturíes para menisco	1147
Separador de vulva	896	SMILLIE Separadores para rodilla	1148
Separador para dedos	1183	SMITH TC Cizallas corta-alambres	180
Separador para muela del juicio	387	SMITH Tijeras para vendajes	1186
Separador para velo del paladar	627	SMITH-BUIE Separadores para el recto	864
Separadores	374-486	SMITH-PETERSEN Gubias	1040
Separadores abdominales	465-477	SMITH-PETERSEN Osteótomos	1039
Separadores costales	769-799	SMITH-PETERSEN Pinzas-gubias	1134
Separadores costales de Aluminio	769-776	SMITHWICK Ganchos para dura-madré	554
Separadores mamaria	794-797	SNELLEN Asas auriculares	728
Separadores nasales	687-690	SOMER Pinzas para el útero	909
Separadores para aorta	816, 817	Sonda abotonada	827, 828
Separadores para atrio	816, 824	Sonda de mirto	62
Separadores para cuerpos vertebrales	592, 593	Sonda doble	827
Separadores para el ramo	386	Sonda para bocio	657
Separadores para escayolas	1193, 1194	Sonda para medir	748
Separadores para la cirugía lumbar vertebral	582-585	Sondas	62-64
Separadores para la columna cervical	568-581	Sondas abotonadas	62
Separadores para la fijación del cráneo	540-542	Sondas acanaladas	63
Separadores para la raíz de nervios	551-553	Sondas auriculares	716
Separadores para la vejiga	952	Sondas conductoras	509-513
Separadores para labios y mejillas	618	Sondas exploradoras para cálculos biliares	872, 873
Separadores para laminectomía	556-559	Sondas metálicas	951
Separadores para mamoplastia	422	Soporte de pecho	638
Separadores para mejillas	619	Soporte de pecho para todos los abre bocas	617
Separadores para partes blandas	384, 385	Soporte para esterilizar las agujas de suture	1223
Separadores para rodilla	1148, 1149	Soportes de valve auriculares	820
Separadores, autoestáticos	445-464	SPENCER-WELLS Pinzas haemostaticas	242
Seperador obstétrica	936	SPRATT Cucharillas cortantes	1097
Seperador para el borde anterior	1057	SPREADY Separadores para laminectomia	589-591
Seperador para el cuerpo mandibular	1057	SPURLING Pinzas cortantes para laminectomía	997
Seperadores mandibulares	1057	ST. CLAIR-THOMSON Cuchillos para adenoides	629
Seperadores para disco intervertebral	594	ST. MARKS Separadores	420
Seperadores para el recto	861, 864-866	ST. MARKS Separadores para el recto	866
Seperadores para la prostata	953	STACKE Sondas abotonadas	62
Seperadores para laminectomia	564-567, 586-591	STANDARD Trócares	69
Seperadores para tráquea	655	STAUDE-MOORE Pinzas para coger el cuello de útero	901
SEUTIN Tijeras para vendajes y Cizallas para escayolas	1191	STEINBACH Martillos	1018
SEWALL Periostótomos	1052, 1060	STELLA TC Tijeras para Face-lift	175
SEXTON Agujas para paracentesis	735	STELLBRINK Pinzas-gubias	1127
SEYFFERT Espéculos vaginales	882	STELZNER Tijeras rectales	107
SHAAF Pinzas depilatorias	223	STERNBERG Separadores para labios y mejillas	618
SHAMBAUGH Micro ganchitos	749	STEVENS Pinzas para iridectomía	197, 208
SHAMBOUGH Adenótomos	630	STEVENS SCT Tijeras finas para cirugía	191
SHAPLEIGH Asas auriculares	729	STEVENS Tijeras finas para cirugía	127, 156
SHEA Cucharilla cortantes	751	STIEGLITZ Pinzas para espinas	1208
SHEEHAN Osteótomos	682	STILLE Cinceles	1032
SIEGLE Lupas auriculares	726	STILLE Cizallas para escayolas	1192
Sierra para escayolas	1195	STILLE Gubias	1033
Sierras de hilo	1010	STILLE Osteótomos	1032
Sierras eléctrica oscilante para autopsia	1022, 1023	STILLE Perforadores de mano	1171
Sierras eléctrica oscilante para yeso	1196-1199	STILLE Pinzas de disección	197
Sierras nasales	685	STILLE Pinzas para los cálculos biliares	878
Sierras para abrir anillos	1011	STILLE Pinzas para pedículo renal	283, 285
Sierras para amputación y resección	1009, 1010	STILLE Pinzas quirúrgicas	207
SILVER Dermátomos	59	STILLE Pinzas-gubias	1136
SILVER Osteótomos	683	STILLE-BARRAYA Pinzas para vasos y tumores	216
SIMON Bisturíes para fístulas	56	STILLE-RUSKIN Pinzas-gubias	1138
SIMON Cucharillas cortantes	1100	STILLE-SHERMAN Perforadores de mano	1171
SIMON Separadores	415, 436	Stilletas	1215
SIMPLEX Separadores para mejillas	619	STOCKMANN Compresoers urétral	946
SIMPSON Forceps obstétrico	932, 933	STOCKMANN Pinza para fijar	946
SIMPSON-LUIKART Forceps obstétrico	934	STONE Pinzas quirúrgicas	218
SIMS Curetas uterinas	900, 927, 930	STONE-WATT Pinza para cerrar clamps	860
SIMS Depresores uterinos	900	STONE-WATT Pinzas-clamps intestinales y estomacales	860
SIMS Espéculos para el recto	862	STRABISMUS Tijeras des disección	112
SIMS Espéculos vaginales	887	STRANDELL-STILLE Separadores	441
SIMS Hosterómetros	899	STRASSBURG Pinzas quirúrgicas	212
SIMS SCT Tijeras uterinas	186	STRATTE Porta-agujas	492
SIMS Seperadores para el recto	861	STRATTE TC Porta-agujas	526
SIMS TC Tijeras uterinas	163, 164	STRAUSS Compresoers urétral	946
SIMS Tijeras uterinas	98, 99, 151	STRONG (COBRA) Pinzas vasculares atraumáticas	318
SIMS-BODENHAMMER Seperadores para el recto	861	STRUCK Separadores costales	782
SIMS-MAIER Pinzas para vendajes	355	STRUEMPPEL Pinzas auriculares	734
SIMS-SIEBOLD Tijeras uterinas	100, 152	STRULLY Tijeras vasculares	131
SINGLEY-TUTTLE Pinzas para agrarr tejidos	204	STRUYKEN Pinzas nasales	990
Sinuscopios	599, 712	SUBRAMANIAN Pinzas vasculares atraumáticas	299
Sistema brazo	478, 479	Sujetador de mano	1182
Sistema distractor para el cuerpo vertebral cervical	560, 561	Surtido para enfermeras	1207
SKENE Pinzas para coger el cuello de útero	903	SWEDISH Disecadores de dura-madré	550



SWEET Pinzas aplicadoras para agrafes	547	TOBOLD Abajalenguas	601
SYPERT Pinzas cortantes para laminectomía	985, 987	TOBOLD Pinzas para pólipos laríngeos	634
SYPERT Pinzas-gubias	1140	TOENNIS Bisturíes para dura-madré	57, 58
SYSTRUNK Tijeras para uñas	1204	TOENNIS Espátula para íntima	814
T		TOENNIS Ganchos para dura-madré	555
TABB Cuchillo para mucosa	745	TOENNIS Pinzas haemostaticas	243, 255
TAKAHASHI Pinzas cortantes para laminectomía	994	TOENNIS Porta-agujas	497
TAKAHASHI Pinzas nasales	757	TOENNIS TC Porta-agujas	531
Taladro para uñas	1207	TOENNIS Tijeras des disección	114
Tambores para esterilización	1224	TOENNIS-ADSON SCT Tijeras des disección	189
Taponador	626	TOENNIS-ADSON TC Tijeras des disección	173
TARNIER Craneoclasto	938	TOENNIS-ADSON Tijeras des disección	115
TARNIER Forceps obstétrico	935	TOHOKU Pinzas de campo	369
TAYLOR Martillo para reflejos	16	Tonómetros	23
TAYLOR Pinzas de disección	200, 201	Torchio per cartilagine	686
TAYLOR Pinzas quirúrgicas	212, 213	Tornillo oral	619
TAYLOR Separadores para rodilla	1148	Torniquete para producir	29
TAYLOR Valvas laterales	558	TOWNLEY Calibrador	22
TAYLOR-BROWN Pinzas quirúrgicas	216	TOYNEBEE Espéculos auriculares	725
TC Cizallas corta-alambres	180	Tractor adecuado	936
TC Pinza para sutura	236	Transformador	27, 42-43
TC Tijeras des disección	167-173	Traqueótomo	653
TC Tijeras finas para cirugía	177, 178	TRAUBE Martillo para reflejos	17
TC Tijeras nasales	174	TRAUTMANN Cinceles	1029
TC Tijeras para amígdalas	174	TRAUTMANN Gubias	1029
TC Tijeras para cirugía	162, 165, 167	TRAVERS Separadores, autoestáticos	456
TC Tijeras para encías	177, 178	TRELAT Espéculos vaginales	882
TC Tijeras para episiotomía	162	TRELAT Periostótomos	1053
TC Tijeras para Face-lift	175, 176	Trépanos para piel	60, 61
TC Tijeras para ginecología	162	TREVES Pinzas quirúrgicas	216
TC Tijeras para histerectomía	166	Trócares	69-71
TC Tijeras para ligatures	181	Trócares para punción torácica	70
TC Tijeras para perineo	162	Trocares para sinuscopía	692
TC Tijeras uterinas	163, 164	Trócares para vesícula biliar	71
TC Tijeras vasculares	179, 180	TROELTSCH Pinzas auriculares y nasales	221
TEALE Pinzas para coger el cuello de útero	904	TROELTSCH-JALASVIRTA Pinzas auriculares y nasales	221
TERRIER Pinzas haemostaticas	259	TROEMMER Martillo para reflejos	16
TESSIER Osteótomos	1033, 1036, 1037	TROUSSEAU Dilatatore traqueales	654
TESSIER Periostótomos	1058	TROUTMAN-CHRIS Porta-hojas	47
TESSIER Pinza para formar huesos	1118	TROUTMAN-CHRIS Rompe-hojas de afeitar	47
TESSIER Tijeras nasales	120	TUBBS Dilatadores para aorta	810
THILENIUS Pinza para abscesos de las amígdalas	623	Tubo de aspiración y coagulación	87
THOMS-ALLIS Pinzas intestinales y para tejidos	364	Tubo del intubation	653
THOMS-GAYLOR Pinzas saca-bocados para biopsia	919	Tubos para aspiración	77-89
THOMSON-WALKER Separadores para la vejiga	952	TUEBINGEN Micro pinzas	227
THOREK TC Tijeras des disección	171	TUEBINGEN Micro-tijeras	140
THOREK Tijeras des disección	113	TUEBINGEN Pinzas para los cálculos biliares	878
THUDICHUM Espéculos nasales	660	TUEBINGEN Separadores	414
TIECK-HALLE Espéculos nasales	660, 661	TUEBINGEN Separadores, autoestáticos	449
Tijeras	91-148	TUFFIER Pinzas intestinales y para tejidos	365
Tijeras abdominales	97, 98	TUFFIER Separadores	403
Tijeras con fi los de carburo tungsteno	160-181	TUFFIER Separadores costales	780
Tijeras de cápsula	105	TURNBULL Pinzas para cortar uñas	1205
Tijeras des disección	108-115, 154-156	TYDING Cierra-nudos para amígdalas	624
Tijeras enterótomos	103	TYDING-TIVNEN Pinzas para amígdalas	621
Tijeras finas para cirugía	123-130, 156-157	U	
Tijeras nasales	118-122, 156, 754	UCKERMANN Porta-algodones	65
Tijeras para amígdalas	116, 117	UCKERMANN Traqueótomo	653
Tijeras para cartilago	115, 116	UFFENORDE Cucharillas cortantes	1114
Tijeras para cirugía	91-97, 103-105, 151-153	ULM Bolso de la emergencia	28
Tijeras para decapitcón	100	ULRICH Bisturíes para fístulas	56
Tijeras para encías	124, 125	ULRICH Pinza para huesos	1122
Tijeras para episiotomía	101, 102, 152	ULRICH Pinzas para tapones	349
Tijeras para Face-lift	117	UNIVERSAL Cizallas corta-alambres	148
Tijeras para ginecología	98-102	UNIVERSAL Pinzas para esterilización	1209
Tijeras para la cirugía plástica	115	UNIVERSAL TC Cizallas corta-alambres	180
Tijeras para ligatures	146, 147	UNIVERSAL Tijeras para vendajes y Cizallas para escayolas	1191
Tijeras para perineo	101, 102, 152	UNIVERSAL Trócares	69
Tijeras para tabique nasal	700	UNNA Extractore para comedones	61
Tijeras para uñas	1204	UNNA-VIDAL Extractore para comedones	61
Tijeras para vendajes y Cizallas para escayolas	1186-1192	Uretrótomo	954
Tijeras rectales	106, 107	USA Cucharillas cortantes	1108, 1109
Tijeras SUPERCUT	150-158	USA Pinzas de disección	196
Tijeras SUPERCUT NITRITO de TITANO	184-192	USA Pinzas quirúrgicas	206
Tijeras umbilicales	102	USA Separadores para escayolas	1194
Tijeras uterinas	98-100, 151, 152	USA Tijera umbilicales	102
Tijeras vasculares	115, 117, 131-137, 158	V	
TILLEY Pinzas para tamponamiento y pólipos nasales	669	VALLEIX Hosterómetros	899
TILLEY-HENCKEL Pinzas nasales	989	Valvas	565
Tirabuzóns para mioma	908	Valve auriculares	820
TISCHLER Pinzas saca-bocados para biopsia	917, 921	VAN BUREN Bujias dilatadoras	950
TISCHLER-KEVORKIAN Pinzas saca-bocados para biopsia	921	VAN BUREN Pinzas para secuestro	1118
TISCHLER-MORGAN Pinzas saca-bocados para biopsia	921, 922	VAN DOREN Pinzas saca-bocados para biopsia	918, 919

VANNAS Micro-tijeras	140	WERTHEIM-CULLEN Pinzas-Clamps para histerectomía	276
VARADY Flebextractor	814	WEST Cinceles	1025
VARADY Flebodisecador	814	WEST Gubias	1025
VARADY Juego para varices	807	WESTCOTT Micro-tijeras	141
VARADY Micro disecador	814	WESTMACOTT Pinzas para tamponamiento y pólipos nasales	669
VASCULAR Porta-agujas	498	WHITE Pinzas para amígdalas	620
Vaso medicinal	1213, 1214	WHITEHEAD Abrebocas	604
Vaso-medidas	1213	WIEDER Abajalenguas	602
VEDDER Cierra-nudos para amígdalas	624	WIEN Espéculos nasales	662
VEIDENHEIMER Pinzas para anastomosis de recto	857	WIEN Escofina para el seno maxilar	693
VERBRUGGE Pinza para huesos	1124	WIEN MOD. Pinzas-Clamps para histerectomía	274
VERHOEVEN Tubos para aspiración	89	WIGMORE Cuchillos para escayolas	1195
VERRES Cánulas para insuflación	73	WIKSTROEM Pinzas de disección y ligaduras	269
VICKERS Disectores	1052	WILDER Estilete para el canal lacrimal	63
VICKERS Elevadores	1052	WILLET Pinza para pericráneo	936
VICKERS Perforadores de mano	1156	WILLET-MARTEL Pinzas intestinales y para tejidos	366
VICKERS Separador para dedos	1183	WILLIAMS Pinzas intestinales y para tejidos	360
VICKERS Separadores	428, 1183	WILLIAMS Separadores, autoestáticos	464
VICKERS Sujetador de mano	1182	WILLIGER Cucharillas cortantes	1094, 1096
VIDAL Rascador para lupus	60	WILLIGER Elevadores	1074
VIENNA Captador de hilos	513	WILLIGER Martillos	1016
Vígorimeter	21	WILLIGER Periostótomos	1053
VIRCHOW Cinel rompe-craneo	1021	WILLIGER Separadores	420
VIRCHOW Cuchillos para autopsia	54	WILMER-WALTER Tijeras nasales	122
VIRCHOW Cuchillos para cerebro	55	WILSON Pinzas para coger el cuello de útero	904
VOLKMANN Cucharillas cortantes	1092, 1096, 1104, 1105	WINTER Pinzas para aborta y placenta	939, 940
VOLKMANN Separadores	374, 378	WIS-FOREGGER Laringoscopios	39
VOLLMAR Cánulas para irrigación vascular	73	WITTNER Pinzas saca-bocados para biopsia	920
VOLLMAR Fleboextractores	808	WOLFF Curetas para lupus	60
VOLTOLINI Espéculos nasales	660	WOLFF Separadores para escayolas	1194
W		WOODSON Disecadores para duramadre	812
WACHENFELDT Pinzas aplicadoras para agrafes	517	WRIGLEY Forceps obstétrico	935
WAGENER Separadores	429	WUERZBURG Abajalenguas	616
WAGNER Elevadores para huesos	1076, 1080, 1081	WULLSTEIN Mango para aspiración	85
WAGNER Gubias	1049	WULLSTEIN Micro pinzas de copas	739
WAGNER Instrumentos de flexión	1170	WULLSTEIN Periostótomos	1054
WAGNER Martillos	1014	WULLSTEIN Separadores, autoestáticos	447
WAGNER Periostótomos	1070	WULLSTEIN Tubos para aspiración	77, 86
WAGNER Pinzas cortantes para laminectomía	985, 986	Y	
WAGNER TC Tijeras finas para cirugía	177	YANKAUER Tubos para aspiración	81, 82
WAGNER Tijeras finas para cirugía	125, 126	YASARGIL Cuchillos para vasos	838
WALB Cuchillos para órganos	55	YASARGIL Disecador	835
WALDMANN TC Tijeras para episiotomía	162	YASARGIL Gancho para galea	545
WALDMANN TCTijeras para perineo	162	YASARGIL Guía-ligadura	829
WALDMANN Tijeras para episiotomía	101, 152	YASARGIL Legra	835
WALDMANN Tijeras para perineo	101, 152	YASARGIL Pinzas cortantes para laminectomía	1005
WALLICH Curettes uterines	911	YASARGIL Tubos para aspiración	80
WALTER Cinceles	682	YASARGIL-NICOLA Micro-pinza de agarre	651
WALTER Ganchito para alas de nariz	688	YEOMANN Pinzas para biopsia rectal	869
WALTER Gubias	1033	YOUNG Pinzas tira-lengua	618
WALTER Osteotomos	682	YOUNG Seperadores para la prostata	953
WALTON Pinzas para biopsia rectal	869	YOUNG-HRYNTSCHAK Agujas para ligaduras	513
WALTON Sierras para abrir anillos	1011	Z	
WALTON-YANKAUER Tubos para aspiración	81	ZANDER Escariadores	1012
WANGENSTEEN Pinzas para agrar tejidos	204	ZAUFAL Elevador auricular	730
WANGENSTEEN Porta-agujas	494	ZAUFAL-JANSEN Gnachitos auriculares	731
WANGENSTEEN TC Pinzas de disección	233	ZAUFAL-JANSEN Pinzas-gubias	1133
WANGENSTEEN TC Porta-agujas	527	ZENKER Pinzas de disección y ligaduras	262, 263
WARTENBERG Algesímetro	20	ZENKER Separadores	391
WARTENBERG Rueda con espinas	20	ZIEGLER Bisturíes para dura-madré	57
WASSMUND Separadores	380	ZIEGLER Espejo frontal	35
WATSON Dermátomos	59	ZIEGLER Pinzas depilatorias	223
WATSON-CHEYNE Disectores	1056	ZIELKE Gubias	1044
WATSON-JONES Elevadores para huesos	1076	ZOELLNER Cuchillo en forma de hoz	752
WATSON-WILLIAMS Pinzas nasales	993, 994	ZOELLNER Cuchillo lanceolado	752
WAUGH Pinzas quirúrgicas	206	ZOELLNER Cuchillos para cortes redondos	752
WEBER Estesímetro	20	ZOELLNER Espéculos auriculares	720
WEBER Pinzas vasculares atraumáticas	312	ZOELLNER Ganchito	752
WEBER-LOCH Asas auriculares	729, 730	ZOELLNER Horquilla	752
WEBSTER Porta-agujas	491	ZOELLNER Micro aguja	752
WEBSTER TC Porta-agujas	525	ZOELLNER Periostótomo	752
WECKER Micro-tijeras	139	ZOELLNER Tubos para aspiración	89
WEIL-BLAKESLEY Pinzas nasales	988, 989	Z-PARAMETRIUM Pinzas-Clamps para histerectomía	286
WEIL-BLAKESLEY Pinzas para etmoides	745		
WEISMAN Curetas auriculares	729		
WEISSBARTH Espéculos vaginales	895		
WEITLANER Separadores, autoestáticos	446, 447, 453, 454		
WEITLANER-BABY Separadores, autoestáticos	449		
WELLER Pinzas para menisco y cartilago	1145		
WERTHEIM Pinzas para anastomosis de recto	859		
WERTHEIM Pinzas-Clamps para histerectomía	271, 272		
WERTHEIM TC Tijeras para histerectomía	166		
WERTHEIM Tijeras uterinas	100		



A			
Abassalingua	601, 602, 615, 616	ASCH Cucchiaio secreto	911
Abasso epiglottide	633	ASH Pinze per setto nasale	698
ABRAHAM Bisturi per tonsille	57	AUFRICHT Divaricatori nasali	687
ABRAHAM Pinze per tonsille	621	AUFRICHT Forbici per la chirurgia plastica	115
Adenotomi	630	AUFRICHT Raspe nasali	1085, 1090
ADLERDYCE Elevatori	1055	Autofissatore per retrattori, per il supporto del craino	540-542
ADLERKREUTZ Pinza vascolare e per tumori	214	AUVARD Speculi vaginali	895
ADSON Divaricatori, autostatici	453, 455, 458-461	AYRE Bisturi per cono	56
ADSON Periostotomi	1059	B	
ADSON Pinze anatomiche per dissezione	198, 199	BABCOCK Pinze da presa per intestino e tessuti	362, 363
ADSON Pinze emostatiche	245, 256	BABINSKY Martelli percussori	17
ADSON Pinze guida sonda	1012	BABY-ADSON Pinze per preparazioni e legature	269
ADSON Pinze per chirurgia	209, 210	BABY-ALLIS Pinze da presa per intestino e tessuti	363
ADSON Pinze per ossa	1131	BABY-COLLIN Divaricatori addominali	466
ADSON Portaghi	489	BABY-CRILE Pinze emostatiche	248, 257
ADSON Puteruoli	1012	BABY-CRILE-WOOD TC Portaghi	523
ADSON TC Pinze anatomiche per dissezione	232	BABY-KOCHER Pinze intestinali	844
ADSON TC Pinze per chirurgia	234	BABY-MIKULICZ Pinze per peritoneo	277
ADSON Tubi aspirazione	78	BABY-MIXTER Pinze per preparazioni e legature	270
ADSON Uncini per dura-madre	554, 555	BABY-MOSQUITO Pinze emostatiche	251
ADSON-BIEMER-MICRO Pinze per chirurgia	211	BABY-OVERHOLT Pinze per preparazioni e legature	270
ADSON-BROWN Pinze per chirurgia	217	BABY-ROUX Divaricatori	416
ADSON-BROWN TC Pinze per chirurgia	235	BABY-SATINSKY Pinze per vena cava	347
ADSON-DE BAKEY Pinze atraumatiche	218	BABY-TISCHLER Pinze per la biopsia cervicale e da prelievo	921
ADSON-GRAEFE Pinze per chirurgia	217	BABY-YANKAUER Tubi aspirazione	81
ADSON-MICRO Pinze anatomiche per dissezione	199	Bacinelle per strumenti	1215, 1216
ADSON-MICRO Pinze per chirurgia	210, 211	Bacinelle reniformi	1212
ADSON-MICRO TC Pinze anatomiche per dissezione	232	BACKHAUS Pinze fissatele	367
ADSON-MICRO TC Pinze per chirurgia	234	BACKHAUS-KOCHER Pinze fissatele	367
ADSON-MINI Pinze per chirurgia	210	BACON Pinze per ossa	1129
Aghi	841	BAGDLEY Divaricatori per laminectomia	559
Aghi chirurgici	514-516	BAILEY Pinze per laminectomia	1007
Aghi conduttori	66-68	BAILEY-GIBBON Approssimatori costali	800
Aghi della cardioplegia	823	BAINBRIDGE Pinze emostatiche	246
Aghi per cerume e portagarze	730	BAINBRIDGE Pinze vascolari atraumatiche	314
Aghi per eparina	73	BAKES Dilatatori per condotti biliari,	872
Aghi per iniezione	72	BALFOUR Divaricatori	485
Aghi per la puntura cieca del fegato	74	BALFOUR Divaricatori addominali	470
Aghi per la puntura dello sterno	73	BALFOUR USA Divaricatori addominali	471
Aghi per legatura	500-509, 626	BALFOUR-BABY Divaricatori addominali	469
Aghi per paracentesi	735-737	BALL & SOCKET Pinze fissatele	368
Aghi per sutura del palato	626	BALLENGER Bisturi per il setto nasale	679
Aghi per tonsille	626	BALLENGER Pinze per tonsille	621
Aghi per tonsille	72	BALLENGER Sgorbie	679
Aghi speciali	72-74	BALLENGER-HAJEK Elevatori per il setto nasale	676
AGNEW Ago per paracentesi	736	BARANY Tamburo rumoroso	716
Agrafe da sutura	516	BARBARA Microaghi	748, 749
Agrafes di argento	546	BARNES Tubi aspirazione	88
ALAN-PARKS Dilatatori per l'ano ed il retto	865	BARNHILL Coltelli per vegetazioni adenoidee	629
ALDINGER Leve per ossa	1081	BARON Tubi aspirazione	88
ALEXANDER Periostotomi	1065	BARR Dilatatori per l'ano ed il retto	861
ALEXANDER Pinze per la biopsia cervicale e da prelievo	920	Barra di trazione per tenaglie per ossa	1126
ALEXANDER Scalpelli	1030	BARRAQUER Micro-forbici	140
ALEXANDER Sgorbie	1030	BARRAQUER Pinze per ciglia	223
Algesiometro (rotella neurologica)	20	BARRON Legatore emorroidale	867
Algesiometro con ago e pennello	20	BARSKY Divaricatori	442
ALLEN Pinze intestinali	844	BARTH Curette auricolari	730
ALLIS Pinze da presa per intestino e tessuti	363, 364	BARTH Curette per ossa	1092
ALLIS-ADAIR Pinze da presa per intestino e tessuti	365	Baule di emergenza	28
ALLISON Spatole per polmone	800	BAUMGARTNER Pinze porta cavo	1159
ALM Divaricatori, autostatici	446	BAYHA Manici per bisturi	44
ALY Algesiometro	20	BAYONET-KERRISON Pinze per laminectomia	968-975
Amnioscopio	864	BEACHAM Amniotomo	903
Amniotomo	903	BEALE Uncino	748
ANDERSON-ADSON Divaricatori, autostatici	453	BEALES Bisturi per tendine	745
Anelli per legature	866	BECK Pinze per laminectomia	994
ANESTOPHONE Stetoscopi	19	BECKMANN Coltelli per vegetazioni adenoidee	628
ANKENEY Divaricatori costali	774, 783	BECKMANN Divaricatori, autostatici	459
Anoscopi	862, 863	BECKMANN Speculi nasali	662
Anse auricolari	728-730	BECKMANN-ADSON Divaricatori, autostatici	462
ANVIL Tronchesini per unghie	1206	BECKMANN-EATON Divaricatori, autostatici	463
Approssimatori costali	800	BEEBEE Forbici taglia cavo	148
Apri gesso	1193, 1194	BEER Pinze per ciglia	223
Apribocca	603-614	BEESON Apri gesso	1193
Apribocca elicoidale	619	BELLUCCI Forbici microauricolari	740
Arcelle	1212	Benda per compressione	29
Archi oer trazione	1154, 1155	BENNETT Leve per ossa	1082
ARKANSAS Pietra per affilare	58	BENGOLEA Pinze emostatiche	243, 255
ARRUGA Portaghi	496	BENSAUDE Anoscopi	862
ARRUGA TC Portaghi	531	BENSON Pinze intestinali	852
Artiglio per tessuti	830	BERGER Pinze per la biopsia cervicale e da prelievo	920
Abdominal KIT II	481	BERGMANN Bisturi per dissezione	51
		BERGMANN Divaricatori	434



BERGMANN Forbici per bendaggi e gessi	1190	BRAUN-STADLER Forbici per perineo	101
BERGMANN Martelli	1015	BREISKY Speculi vaginali	894
BERGMANN Seghe per gessi	1195	BREISKY WIENER Speculi vaginali	894
BERLIN Curette per biopsia	913	BRIDGE Pinze per preparazioni e legature	264
BERLIN Pinze serratubi	370	BRODIE Sonde scanalate	64
BERLINER Martelli percussori	16	BROM Divaricatori	431
BERNHARD Pinze fissatele	368	Bronchoscopia	658, 659
BERTILON Calibro	20	BROPHY Pinze anatomiche per dissezione	202
BETHUNE Costotomi	765	BROPHY Pinze per chirurgia	214
BEYER Pinze per ossa	1130, 1133	BROWN Pinze per afferrare tessuti	217
Bicchieri per medicinale	1213, 1214	BROWN Portaghi	490
Bicchieri graduati	1213	BRUENINGS Bisturi per tonsille	57
BIEMER Divaricatore vasi	827	BRUENINGS Coltelli per setto nasale	672
BILL Manico a trazione	936	BRUENINGS Lenti auricolari	727
BILLEAU Anse auricolari	729	BRUENINGS Pinze per Broncho-esofagoscopia	637
BIRCHER Bisturi per menisco	1147	BRUENINGS Pinze per setto nasale	697
BIRCHER Pinze da presa per menisco e cartilagine	1145	BRUENINGS Serranodi per tonsille	623
BIRCHER Retrattori per ginocchio	1148	BRUENINGS Spatole per lingua	600
BIRCHER-GANSKE Pinze da presa per menisco e cartilagine	1145, 1146	BRUENINGS Tubi di prolungamento	636
BIRKETT Pinze emostatiche	249	BRUENINGS-BRUNK Divaricatori nasali	687
Bisturi a falce	691	BRUENINGS-LUCAS Scalpelli	1029
Bisturi a falda	745	BRUENINGS-LUCAS Sgorbie	1029
Bisturi a lancetta	837	BRUNETTI Scalpelli	1049
Bisturi a rullo	746	BRUNNER Aghi per legatura	502, 509
Bisturi da discissione	745	BRUNNER Costotomi	768
Bisturi enucleatore per tonsille	622	BRUNNER Divaricatori	396-398, 415
Bisturi falciforme	745, 746, 748, 752	BRUNNER Pinze per anastomosi del retto	855
Bisturi lanceolato	747, 752	BRUNNER Sonde conduttrici	509, 511
Bisturi per ascesso	57	BRUNS Curette per ossa	1095, 1106, 1107
Bisturi per cono	56	BRUNS Forbici per bendaggi e gessi	1190, 1191
Bisturi per dissezione	51	BRYANT Pinze per medicazione	352
Bisturi per fibromi	56	BUCHWALD Spatole per lingua	600
Bisturi per fistole	56	BUCK Curette auricolari	728
Bisturi per foruncoli	735	BUCK Forbici per legature	147
Bisturi per il setto nasale	679	BUCK Martelli percussori	16
Bisturi per menisco	1146, 1147	BUCK Miringotomo	735
Bisturi per mucosa	745	BUCK Pinze per corpi estranei	731
Bisturi per nervo trigemino	56, 57	BUCK-GRAMCKO Leve per ossa	1075
Bisturi per plastica nasale	672, 673	BUECHS Periostotomi	1063
Bisturi per tendine	745	BUELAU Trequarti	70
Bisturi per tonsille	57, 623	BUMM Curette uterine	928, 929
Bisturi per uso unico	49	BUMM Pinze per polipi e ovaie	356
Bisturi per vasi	827, 838	BUNNELL Eucleatore per tendine	1152, 1153
Bisturi rotondi	746, 752, 753	BUNNELL Trapani a mano per ossa	1172
BLAKE Pinze per calcoli biliari	877	BUNT Pinze per sterilizzazione	372
BLAKESLEY Pinze nasali	757	BURFORD Divaricatori costali	775-777
BLAKESLEY-WIGAND Pinze nasali	991	BURKE Pinze per la biopsia cervicale e da prelievo	920
BLOHMKE Pinze per tonsille	621	BUSCH Forbici ombelicali	102
BLOUNT Retrattori per ginocchio	1149	BUSHE Curette per ossa	1113
BLUMENTHAL Pinze per ossa	1128	C	
BOEHLER Cesioie per ossa	1142	CAIRNS Pinze emostatiche	251
BOEHLER Pinze per ossa	1132	Calibro	20,22, 559
BOERMA Pinza obsterica	934	CANADIAN Bisturi per menisco	1147
BOETTCHER Forbici per tonsille	116	Candelette dilatatrici	949, 950
BOIES Elevatori per fratture nasal	698	Cannula per insufflazione	73
BONACCOLTO Pinze per sutura	198	Cannule per irrigazione del seno mascellare	88
BONN Forbici fine per chirurgia	129	Cannule per irrigazione vascolare	73
BONN Micro-pinze	227	Cannule per la puntura del ventricolo cerebrale	80
BONNEY Pinze anatomiche per dissezione	203	Cannule per uterine	915
BONNEY Pinze da presa per intestino e tessuti	360	Cannule per vene	72
BONNEY Pinze per chirurgia	215	Cannule tracheali	654, 655
BONNEY TC Pinze anatomiche per dissezione	233	CAPLAN Cesioia per setto nasale	700
BONNEY TC Pinze per chirurgia	235	CARDIOBASE Divaricatori costali	798, 799
BOROWSKI Divaricatori per aorta	817	CARDIOPHONE Stetoscopi	19
BOSE Divaricatori, autostatici	445	Caricabatteria per batterie	42
BOSE Uncini tracheali	655	CARMALT Pinze per schegge	225
BOUCHERON Speculi auricolari	723	CAROLL Pinze passa tendine	1151
BOWLES Stetoscopi	18	CAROLL Goniometro per le dita	20
BOWMAN Stilette per canale lacrimale	62	CARPENTER Bisturi enucleatore per tonsille	622
BOYNTON Portaghi	497	CARPENTER Dissettori per tonsille	622
BOYS-ALLIS Pinze da presa per intestino e tessuti	365	CARREL Pinze emostatiche	251
BOZEMANN Forbici vascolari	131	CASPAR Sistema distrattore per il corpo vertebrale cervicale	560, 561
BOZEMANN Pinze per medicazione	353	CASPAR Calibro	559
BOZEMANN Portaghi	493	CASPAR Curette	1110
BOZEMANN TC Portaghi	526	CASPAR Curette per ossa	1101-1103
BOZEMANN-DOUGLAS Pinze per medicazione	353	CASPAR Dissettoie	832, 833
BRAND Pinze passa tendine	1152	CASPAR Divaricatori	388
BRAUN Cranioclasto	938	CASPAR Divaricatori per colonna cervicale	568-579
BRAUN Depressori uterini	900	CASPAR Divaricatori per colonna lombo vertebrale	582, 584
BRAUN Pinze per abbassare il collo dell'utero	901, 908	CASPAR Divaricatori per laminectomi	564-567
BRAUN Speculi vaginali	892	CASPAR Manici per bisturi	825
BRAUN Unico per detroncazione	937	CASPAR Periostotomi	562, 563
BRAUN-STADLER Forbici per episiotomia	101	CASPAR Pinze per laminectomia	987, 1000-1004



CASPAR Pinze per laminectomia, smontabile	1002, 1003	Coltello per gessi	1195
CASPAR Punzone per sutura	828	Coltello per lobi	52
CASPAR Punzoni	1024	Coltello per mucosa	673
CASPAR Separatori pr le radici dei nervi	552	Coltello per perios	53
CASPAR Speculi per chirurgia lombo vertebrale	585	Coltello per plastica nasale	672
CASPAR Unici per esplorazione e coagulazione	834	Coltello per resezione	53, 54
CASTANEDA Divaricatori costali	773, 774	Coltello per scalfire la cartilagine	672
CASTANEDA Pinze vascolari per neonati	298-299	Coltello per setto nasale	672, 673
CARSTENS Trequarti	70	Coltello per trapianti	58
CASTROVIEJO Micro-forbici	138, 139	Coltello per vegatazioni adenoidee	628, 629
CASTROVIEJO Micro-pinze	226	Coltello periostio	735
CASTROVIEJO Pinze per afferrare	47	COM divaricatori	1057
CASTROVIEJO Pinze per rompere le lamette de rasoio	47	Compressorio	1181
CASTROVIEJO Stilette per canale lacrimale	63	CONE Curette anulari	1111
Catetere guida	947	CONE Pinze per ossa del cranio	549
Cateteri metallici	951	CONVERSE Coltelli per plastica nasale	673
CATLIN Coltelli per amputazione	52	CONVERSE Divaricatori nasali	687
CAWOOD-MINNESOTA Separatori per labbra e guancia	618	CONVERSE Osteotomi	682
Cesoia per setto nasale	700	CONVERSE Uncino per ali nasali	688
Cesoie per ossa	1141-1144	COOLEY Dilatatori per aorta	810
CHADWICK Forbici fine per chirurgia	123	COOLEY Dilatatori vascolari	808
CHAPUT Pinze da presa per intestino e tessuti	366	COOLEY Divaricatori costali	769-771, 788, 789
CHARNLEY Divaricatori addominali	475	COOLEY Divaricatori per atrio	816
CHARRIÈRE Seghe per amputazione e resezione	1009	COOLEY Gancio atriale	797
CHEATTLE Pinze per strumenti sterilizzati	1209	COOLEY Pinze atraumatiche	219, 220
CHELSEA Proctoscopi	862	COOLEY Pinze vascolari atraumatiche	304, 305, 326, 330, 335-339, 342-345
CHERON Pinze per tamponi	354	COOLEY Tubi aspirazione	83
CHEVALIER Divaricatori costali	781	COOLEY-BECK Pinze vascolari atraumatiche	340
CHEVALIER-JACKSON Cannule tracheali	655	COOLEY-LEITZ Pinze vascolari atraumatiche	340
CHILDE Pinze per applicare le agrafe	517	COOPER Agghi per legatura	502
CHURCH Forbici vascolari	132	COPE Divaricatori	440
CINELLI Osteotomi	683	CORDES Pinze per Broncho-esofagoscopia	637
CITELLI Pinze per laminectomia	958	CORWIN Pinze porta cavo	1160
CITELLI-BEYER Pinze per laminectomia	958	CORYLLOS Costotomi	766
Clamp ombelicale	937	CORYLLOS Divaricatori	395
Clamps Bulldog	288-297	Costotomi	764-768
CLAR Lampade frontali	26	COTTLE Coltelli per plastica nasale	673
CLASSON Forbici vascolari	132	COTTLE Divaricatori nasali	690
CLAUS V. EICKEN Agghi per tonsille	626	COTTLE Elevatori per il setto nasale	677, 678
CLEVELAND Cesoie per ossa	1141	COTTLE Forbici nasali	120
CLEVELAND Pinze per ossa	1128	COTTLE Forbici nasali	122
CLOVER Pinze per tonsille	620	COTTLE Martelli	1013
CLOWARD Divaricatori per colonna cervicale	580, 581	COTTLE Osteotomi	680, 1031
CLOWARD Pinze per laminectomia	1006	COTTLE Periostotomi	1060
CLOWARD Separatori per vertebre	592, 593	COTTLE Pinza di fissaggio	686
CLOWARD Separatori pr le radici dei nervi	553	COTTLE Pinza per columella	686
COAKLEY Curette per seno mascellare	690-692	COTTLE Raspe nasali	1084
COAKLEY Trequarti per puntura del seno mascellare	71	COTTLE Scalpelli	680, 681
COBB Curette	1112	COTTLE Speculi nasali	666-668
COBB Elevatori	1072, 1073	COTTLE TC Forbici per tonsille	174
COBB Sgorbie spinali	1050	COTTLE Torchio per cartilagine	686
COBETT Dermotomi	59	COTTLE Uncino per ali nasali	688, 689
COBRA Pinze vascolari atraumatiche	318	COTTLE-KAZANJIAN Cesoie per ossa	1141
COEN Cannule per uterine	915	COTTLE-KNAPP Forbici nasali	122
COHEN Periostotomi	1055	COTTLE-MASING Forbici nasali	122
COLCLOUGH Pinze per laminectomia	984	COTTLE-NEIVERT Uncino per ali nasali	689
COLLER Pinze emostatiche	246	COTTLE-WALSHAM Pinze per setto nasale	698, 699
COLLIER Portaghi	492	COUPLAND Tubi aspirazione	82
COLLIN Clamp ombelicale	937	CRAFOORD Forbici per ginecologia	101
COLLIN Dinamometro	20	CRAFOORD Pinze per preparazioni e legature	266
COLLIN Divaricatori	420	CRAFOORD-SELLORS Pinze per preparazioni e legature	266
COLLIN Divaricatori addominali	466, 467	CRAIG Pinze per setto nasale	696
COLLIN Manici per bisturi	47	Cranioclasto	938
COLLIN Martelli	1016	CREDO Lima per cute ispessita	1207
COLLIN Pelvimetro	931	CRILE Divaricatori	419, 430
COLLIN Pinze da presa per intestino e tessuti	361	CRILE Pinze emostatiche	248, 258
COLLIN Pinze da presa per lingua	618	CRILE Portaghi	497
COLLIN Pinze per afferrare l'utero	910	CRILE-MURRAY Portaghi	490
COLLIN Pinze per afferrare organi	358	CRILE-RANKIN Pinze emostatiche	246, 257
COLLIN Pinze per applicare le agrafe	518	CRILE-WOOD Portaghi	490
COLLIN Pinze per medicazione	354	CRILE-WOOD TC Portaghi	522
COLLIN Speculi vaginali	880	CRUTCHFIELD Pinza per trazione craniale	548
COLLIN-DUVAL Pinze da presa	204	Cucchia taglianti	751
COLLIN-HARTMANN Divaricatori	416	Cucchiai per calcoli biliari	873, 874
COLLIN-LOKTITE Divaricatori addominali	467	Cucchiai per placenta e per ovaie	942
Colonna vertebrale KIT	482	Cucchiai uterine	911
COLLYER Pelvimetro	931	Cucchiaio per cerume e gancio	730
Coltello interosseo	53	Cucchiaio per colecisti	873
Coltello per amputazione	52	Cucchiaio per medicine	1213
Coltello per autopsie	54, 55	Cucchiaio secreto	911
Coltello per cartilagini	53, 54	Curette	703, 704, 706-708, 831, 832, 840, 841, 1110-1112
Coltello per cervello	55	Curette anulari	1111
Coltello per dura-madre	57, 58, 553	Curette auricolari	728-730

Curette per aspirazione	914	Depressori uterini	900
Curette per biopsia	912-914	DERF (WRIGHT) Portaghi	491
Curette per lupus	60	DERF TC Portaghi	525
Curette per ossa	1091-1114	DERF-CONVERSE Portaghi	492
Curette per seno mascellare	690-692	DERF-CONVERSE TC Portaghi	525
Curette uterine	900, 924-930	Dermatologia	60, 61
CUSCO Speculi vaginali	880-882	Dermotomi	59
CUSHING Divaricatori	430, 437, 441, 444	DERRA Pinze vascolari atraumatiche	304
CUSHING Pinze anatomiche per dissezione	202	DESCHAMPS Aghi per legatura	503-508
CUSHING Pinze per chirurgia	213	DESJARDINS Cucchiai per calcoli biliari	873
CUSHING Pinze per laminectomia	995, 998	DESJARDINS Pinze per calcoli biliari	878
CUSHING Spatole cerebrali	543	DESJARDINS Pinze per peduncoli renali	282
CUSHING TC Pinze anatomiche per dissezione	233	DESJARDINS Sonde per calcoli biliari	872
CUSHING Uncini per dura-madre	555	DESMARRES Divaricatori	436
CUSHING-BROWN Pinze per chirurgia	216	Detergente per strumenti	1227
CUSHING-KOCHER Divaricatori	437	Diapason	713-715
CUSHING-LANDOLT Speculi per ipofisi	702	DICK Pinze per isterectomia	276
CUZZI Cucchiai per placenta e per ovaie	942	DIEFFENBACH Clamps Bulldog	292
CZERNY Dilatatori per l'ano ed il retto	861	DIETER Pinze per la testa del martelletto	744
CZERNY Divaricatori	420	DIETHRICH Clamps Bulldog	291
CZERNY Pinze per abbassare il collo dell'utero	906	DIETRICH Pinze vascolari atraumatiche	334
D		DIETRICH-VASCULAR TC Portaghi	532
DAHLGREN Pinze per ossa del cranio	549	Dilatatore per collo vescicale	953
DAHMEN Osteotomi	1051	Dilatatori per aorta	810
DAHMEN Sgorbie	1051	Dilatatori per condotti biliari	872
DALE Pinze vascolari atraumatiche	329	Dilatatori per l'ano ed il retto	861, 864-866
DANDY Forbici vascolari	132	Dilatatori per seno frontale	753
DANDY Pinze emostatiche	249, 258	Dilatatori per tracheotomia	654
DANDY Uncini per dura-madre	554	Dilatatori uterini	897
DARDIK Pinze vascolari atraumatiche	346	Dilatatori vascolari	808, 809, 827
DARLING Divaricatori, autostatici	452	Dinamometro	20
DARTIGUES Pinze per afferrare l'utero	909	DINGMANN Abassalingua	615
DAUBENSPECK Curette per ossa	1099	DINGMANN Apribocca	606
DAUTREY-MUNRO Osteotomi	1034	DINGMANN Tenaglie per ossa	1117
DAVIDSON Divaricatori	411	DIPLOMAT Sfigmomanometri	25
DAVIS Pinze per strumenti sterilizzati	1209	Dissetto	703, 708, 753, 831, 832, 835, 840, 1052, 1056
DAVIS Spatola per intima	813	Dissettori per la dura-madre	550, 551, 812, 813
DAVIS-BOYLE Abassalingua	616	Dissettori per tonsille	622, 623
DAVIS-BOYLE Apribocca	608-612	Dissettori sferici	840
DAVIS-MEYER Abassalingua	616	Dissettori vascolari	814
DAVIS-MEYER Apribocca	607	Distributore lame	48
DAY Uncini auricolari	731	Distributori di cotone	1217
DE BAKEY Clamps Bulldog	288, 289	DITTEL Catetere guida	947
DE BAKEY Dilatatori vascolari	809	Divaricatore mammoplastica	422
DE BAKEY Divaricatori costali	786, 787	Divaricatore per dita	1183
DE BAKEY Divaricatori, autostatici	464	Divaricatore per ossa e articolazione	1184
DE BAKEY Forbici per dissezione	115	Divaricatore per velo pendulo	627
DE BAKEY Forbici vascolari	134, 135	Divaricatore vasi	827
DE BAKEY Pinze atraumatiche	219, 220	Divaricatore vulvare	896
DE BAKEY Pinze vascolari atraumatiche	300-303, 309-311, 313, 314, 316, 317, 321, 322, 325, 328, 330	Divaricatori	374-486
DE BAKEY TC Forbici vascolari	179	Divaricatori addominali	465-477
DE BAKEY TC Pinze atraumatiche	236	Divaricatori atrio	824
DE BAKEY TC Portaghi	522, 523	Divaricatori costali	769-799
DE BAKEY Tubi aspirazione	84	Divaricatori costali in Alluminio	769-776
DE BAKEY-BAHNSON Pinze vascolari atraumatiche	310	Divaricatori epicardici	817
DE BAKEY-BECK Pinze vascolari atraumatiche	305	Divaricatori mammaria	794-797
DE BAKEY-CAROTIS Clamps Bulldog	297	Divaricatori nasali	687-690
DE BAKEY-DIETHRICH Clamps Bulldog	294	Divaricatori per aorta	816, 817
DE BAKEY-MIXTER Pinze vascolari atraumatiche	300	Divaricatori per atrio	816
DE BAKEY-MOSQUITO Pinze vascolari atraumatiche	307	Divaricatori per colonna cervicale	568-581
DE BAKEY-PEAN Pinze vascolari atraumatiche	306	Divaricatori per colonna lombo vertebrale	582-585
DE BAKEY-RANKIN Pinze vascolari atraumatiche	307	Divaricatori per disco intervertebrale	594
DE BAKEY-RUMEL Pinze vascolari atraumatiche	300	Divaricatori per laminectomi	556-559, 564-567, 586-591
DE BAKEY-SATINSKY Clamps Bulldog	297	Divaricatori per tessuti molli	384, 385
DE BAKEY-SATINSKY Pinze vascolari atraumatiche	331	Divaricatori vescicali	952
DE LEE Pinza obsterica	932	Divaricatori, autostatici	445-464
DE MARTEL Guida per fili per sega	549	DIXON-LOVELACE Pinze emostatiche	247, 257
DE MARTEL-WOLFSON Pinze anastomosi	845	DOCKHORN Divaricatori	387
DE MARTEL-WOLFSON Portapinze	845	DOUAY Pinze per la biopsia cervicale e da prelievo	920
DE MARTEL-WOLFSON Serrapinze	845	DOUGHTY Abassalingua	615
DE VILBISS Pinze per ossa del cranio	549	DOUGLAS Pinze per ciglia	223
DEAN Forbici per tonsille	116	DOUGLAS Trequarti per puntura del seno mascellare	71
DEAN TC Forbici per tonsille	174	DOYEN Abassalingua	602
DEAVER Divaricatori	426, 427, 485	DOYEN Divaricatori	402
DEAVER Forbici per chirurgia	96	DOYEN Divaricatori addominali	480
DECKER Pinze per laminectomia	1006	DOYEN Forbici per pareti abdominali	97, 98
DEJERINE Martelli percussori	16	DOYEN Periotostomi	1066, 1067
DEMEL Guida cavo	1158	DOYEN Pinze fissatele	368
DEMEL Strumenti per cerchiaggio	1158	DOYEN Pinze intestinali	844-847
DENHARDT Apribocca	603	DOYEN Pinze per polipi e ovaie	356
DENNIS-BROWNE Divaricatori addominali	471	DOYEN Portaghi	492
DENNIS-BROWNE Pinze per afferrare tessuti	204	DOYEN Sonde scanalate	63
		DOYEN Speculi vaginali	893



DOYEN Succhielli per fibroma	908	FILIFORM Candelette dilatatrici	949
DOYEN-CHILD Divaricatori addominali	480	Filo per ossa	1157
DOYEN-COLLIN Apribocca	603	Filo per serranodi	624, 652, 671, 738
DOYEN-JANSEN Apribocca	603	FINOCHIETTO Divaricatori costali	771-773, 784, 785
DOYEN-STILLE Divaricatori	408	FINOCHIETTO Pinze per preparazioni e legature	280
DRAFFIN Supporto per gli apribocca	617	FINOCHIETTO Portaghi	494
DUBOIS Forbici per decapitazione	100	FINOCHIETTO TC Portaghi	527
DUEHRSSSEN Pinze anatomiche per dissezione	203	FINSSEN Divaricatori, autostatici	445
DUEHRSSSEN Pinze per chirurgia	215	FINSTERER Tubi aspirazione	84
DUKE Tre quarti	71	FISCHER Bisturi per tonsille	623
DUNN-DAUTREY Osteotomi	1026	FISCHER Enuclatore per tendine	1153
DUPLAY Pinze per abbassare il collo dell'utero	902	Fissatore per mano	1182
DUPLAY Pinze per medicazione	351, 352	Flebo-dissetto	814
DUPLEX Stetoscopi	18	Flebo-estrattore	814
DUPUY-WEISS Aghi per legatura	626	FOERSTER Pinze per tamponi e spugne	359
DURANTE Pinza vascolare e per tumori	218	FOERSTER-BALLENGER Pinze per tamponi e spugne	359
DUVAL Pinze da presa	204	FOMON Coltelli per plastica nasale	672
DUVAL Pinze da presa per intestino e tessuti	360, 361	FOMON Forbici nasali	118, 119, 121
DUVAL-COLLIN Pinze da presa per intestino e tessuti	361	FOMON Osteotomi	683
E		FOMON Raspe nasali	1086, 1090
ECHLIN Pinze per ossa	1135	FOMON SCT Forbici nasali	189
EDER Portacotone	66	FOMON TC Forbici per tonsille	174
EICKEN Cannule per irrigazione del seno mascellare	88	FOMON Uncino nasale ad anello	689
EISELSBERG Forbici per legature	147	FOMON Uncino per ali nasali	688, 689
EISELSBERG Portaghi	497	Forbice per capsula	105
Elastico naso-pharyngo-laryngofiberscopia	598	Forbice per dissezione rettale	106, 107
Elevatori	737, 840, 1052-1056, 1072-1074	Forbici	91-148
Elevatori d'aspirazione	674, 678	Forbici con lame in carburo i tungsteno	160-181
Elevatori per fratture nasal	698	Forbici da utero	98-100, 151, 152
Elevatori per il setto nasale	674-678	Forbici fine per chirurgia	123-130, 156-157
ELSAESSER Pinze per nefrostomia	876	Forbici microauricolari	740, 744
EMMET Divaricatori	436	Forbici nasali	118-122, 156, 754
EMMET Pinze per medicazione	354	Forbici ombelicali	102
Endospeculi	896	Forbici per bendaggi e gessi	1186-1192
ENGEL Seghe per gessi	1195	Forbici per cartilagini	115, 116
Enucleatore	705	Forbici per chirurgia	91-97, 103-105, 151-153
Enucleatore per tendine	1152, 1153	Forbici per decapitazione	100
EPPENDORF Pinze per la biopsia cervicale e da prelievo	920, 922	Forbici per dissezione	108-115, 154-156
Escavatore	747	Forbici per enterotomia	103
ESMARCH Coltelli per gessi	1195	Forbici per episiotomia	101, 102, 152
ESMARCH Forbici per bendaggi e gessi	1190	Forbici per Face-lift	117
Estesiometro	20	Forbici per gengiva	124, 125
EVES Serranodi per tonsille	623	Forbici per ginecologia	98-102
EWALD Pinze anatomiche per dissezione	198	Forbici per la chirurgia plastica	115
EWALD Pinze per chirurgia	209	Forbici per legature	146, 147
F		Forbici per pareti addominali	97, 98
FAHLBUSCH Curetta	707	Forbici per perineo	101, 102, 152
FAHLBUSCH Curetta	707	Forbici per tonsille	116, 117
FAHLBUSCH Microforbici da presa	651	Forbici per unghie	1204
FANSLER Anoscopi	862	Forbici SUPERCUT	150-158
FARABEUF Divaricatori	417	Forbici SUPERCUT NITRITO di TITANO	184-192
FARABEUF Periostotomi	1063	Forbici taglia cavo	148
FARABEUF Tenaglie per ossa	1120	Forbici vascolari	131-137, 158
FARABEUF-COLLIN Periostotomi	1063	Forbici vascolari	115, 117
FARABEUF-LAMBOTTE Tenaglie per ossa	1120	Forcella di guida	747, 752
FARRELL Portacotone	65	Forchetta da sutura	513
FARRIOR Specoli auricolari	720, 724	Forchetta per impiantare	705
Fascia frontale	35	FORD-DIXON Legatore emorroidale	868
FAULKNER Curette per seno mascellare	690	FORMBY Cucchiato per cerume e gancio	730
FAURE Pinze per isterectomia	272	FOSTER-GILLIES TC Portaghi	528
FAURE Pinze per la biopsia cervicale e da prelievo	916	FOWLER Bisturi per tonsille	57
FAURE Pinze per peritoneo	278	FOX Curette per lupus	60
FAVALORO Forbici vascolari	134	FRAENKEL Pinze per Broncho-esofagoscopia	637
FAVALORO Divaricatori costali	775	FRAENKEL Pinze per polipi laringei	634, 635
FEHLAND Pinze per anastomosi del retto	856	FRANCKE Lancetta pungidito	29
FEILCHENFELD Pinze per schegge	225	FRANZ Divaricatori addominali	474
FEIN Portacotone	633	FRASER-KELLY Pinze emostatiche	248
FELDHEIM Compressorio	1181	FRAZIER Cannule per la puntura del ventricolo cerebrale	80
FERGUSON Cucchiati per calcoli biliari	874	FRAZIER Dissettori per la dura-madre	551
FERGUSON Forbici per chirurgia	97	FRAZIER Tubi aspirazione	77
FERGUSON Pinze intestinali	853	FRAZIER Uncini per dura-madre	555
FERGUSON Pinze per anastomosi del retto	855	FREEMAN-GORNEY TC Forbici per Face-lift	176
FERGUSON Tenaglie per ossa	1119	FREEMAN-KAYE TC Forbici per Face-lift	176
FERGUSON Tubi aspirazione	78, 79	FREER Coltelli per mucosa	673
FERGUSON-ACKLAND Apribocca	603	FREER Divaricatori	443
Fermapinza	936	FREER Elevatori	1054
FERRIS-SMITH Pinze per chirurgia	215	FREER Elevatori per il setto nasale	674, 675
FERRIS-SMITH TC Pinze per chirurgia	235	FREER Scalpelli	1025
FERRIS-SMITH-CUSHING Pinze per laminectomia	979-983	FREER Sgorbie	1025
FERRIS-SMITH-CUSHING Pinze per laminectomia, smontabile	981, 983	FREER-GORNEY Elevatori d'aspirazione	674
FERRIS-SMITH-KERRISON Pinze per laminectomia	960-967, 978	FREER-JOSEPH Elevatori per il setto nasale	675
FICKLING Pinze per preparazioni e legature	269	FREER-YASARGIL Elevatori per il setto nasale	674
Fili per sega	1010	FRENZEL Spatole per lingua	600



FRIEDMANN-JOLL Divaricatore vulvare	896	GROSS-MAIER Pinze per medicazione	349, 350
FRIEDMANN-MINI Pinze per ossa	1127	GRUBER Specoli auricolari	725
FRIEDMANN-VICKERS Pinze per ossa	1127	GRUENWALD Pinze nasali	757
FRITSCH Divaricatori	403	GRUENWALD Polverizzatori	761
FRY Pinze nasali	990	GRUENWALD-HENKE Pinze nasali	991
FRYKHOLM Pinze per ossa	1136	GRUENWALD-JANSEN Pinze auricolari e nasali	222
FUCHSIG Pinze emostatiche	247	Guancio per mento	383, 1057
FULLER Pinza per introduzione per protesi in teflon	742	Guida cavo	1158, 1159
G		Guida per fili per sega	549
GALLAHER Raspe nasali	1085	Guida per legatura	829
Ganci galea	545	Guida per tendine	1153
Gancio atriale	792, 797	GUILLEN Elevatori d'aspirazione	678
Gancio fenestrato	747	GUILFORD-WRIGHT Forbici taglia cavo	148
GARDNER Cesoie per ossa	1141	GULEKE Pinze per ossa	1131
GARRETT Dilatatori vascolari	809	GUNAR-HEY Pinze serratubi	371
GAST Abassalingua	615	GUSTELLA Osteotomi	684
GAUSS Pinza per il cuoio capelluto	936	GUTHRIE Divaricatori	432
GELFOAM Pinze per setto nasale	701	GUYON Candelette dilatatrici	949
GELLHORN Pinze per la biopsia cervicale e da prelievo	919	GUYON Catetere guida	947
GELPI Divaricatori	485	GUYON Pinze per peduncoli renali	282-284
GELPI-LOKTITE Divaricatori, autostatici	456, 457	GWYNE-EVANS Dissettori per tonsille	623
GELPI-SEILETZ Divaricatori, autostatici	457	H	
GEMINI Pinze per preparazioni e legature	265	HABERER Spatole addominali e intestinali	421
GERALD Pinze anatomiche per dissezione	202	HACKSTOCK Pinze porta cavo	1161
GERALD Pinze auricolari e nasali	222	HAGLUND-STILLE Apri gesso	1193
GERALD Pinze per chirurgia	214	HAIGHT Divaricatori costali	781
GERALD TC Pinze anatomiche per dissezione	233	HAJEK Martelli	1013
GERALD TC Pinze per chirurgia	235	HAJEK Pinze nasali	991
GERALD-BROWN Pinze per chirurgia	216	HAJEK Tubi aspirazione	87
GERSTER Barra di trazione per tenaglie per ossa	1126	HAJEK-CLAUS Pinze per laminectomia	958
GERZOG Martelli	1017	HAJEK-KOFLER Pinze per laminectomia	959
GERZOG-SEXTON Ago per paracentesi	735	HAKANSSON Pinze per ossa	1128
Ghiacciaia unghie	1207	HALLE Coltello per dura-madre	553
GIERTZ-STILLE Costotomi	767	HALLE Curette per ossa	1098
GIGLI Fili per sega	1010	HALLE Elevatori per il setto nasale	674
GIGLI Manico ad uncino per fili per sega	1010	HALSEY Portaghi	491
GILLIES Divaricatori	442	HALSEY TC Portaghi	524
GILLIES Osteotomi	1026	HALSTED-MOSQUITO Pinze emostatiche	244, 250, 256, 258, 259
GILLIES Pinze anatomiche per dissezione	199	HARDY Curetta	707
GILLIES Pinze per chirurgia	211	HARDY Eucleatore	705
GILLIES Portaghi con forbici	495	HARDY Forchetta per impiantare	705
GILLIES TC Pinze per chirurgia	234	HARDY-FAHLBUSCH Dissettori	703
GILLIES TC Portaghi	528	HARGIS Separatore per il corpo mandibulare	1057
GILLIES-MINI TC Portaghi	528	HARGIS Separatore per il borde anteriore	1057
GILL-VERNET Divaricatori	438	HARKEN Pinze per vena cava	348
GLASSMANN Pinze atraumatiche	218	HARKEN Pinze vascolari atraumatiche	334
GLOVER Clamps Bulldog	290, 296	HARRINGTON Divaricatori	409
GLOVER Pinze vascolari atraumatiche	303, 315, 316	HARRINGTON Divaricatori	485
GLUCK Costotomi	764	HARRINGTON-PEMBERTON Divaricatori	409
GOLDMANN Elevatori per fratture nasal	698	HARTMANN (FRENCH) Diapason	713
GOLDMANN-FOX Forbici per gengiva	125	HARTMANN Abassalingua	601
GOLDMANN-FOX TC Forbici per gengiva	177	HARTMANN Diapason	713-715
GOELET Divaricatori	418	HARTMANN Pinze auricolari	732, 733
GOMEL Micro-forbici	143	HARTMANN Pinze emostatiche	250
Goniometro	20	HARTMANN Pinze intestinali	846
Goniometro per le dita	20	HARTMANN Pinze nasali	992
GOOD Forbici per tonsille	117	HARTMANN Pinze per ossa	1129
GOOD-SCHWEKENDIECK Forbici per tonsille	117	HARTMANN Pinze per polipi auricolari	732
GORNEY Forbici per dissezione	113	HARTMANN Pinze per tamponi e polipi nasali	669, 670
GORNEY TC Forbici per Face-lift	175	HARTMANN Portacotone	633
GORNEY-FREEMAN TC Forbici per Face-lift	176	HARTMANN Sonda auricolare	716
GOSSET Divaricatori addominali	469	HARTMANN Specoli auricolari	721-723
GOSSET-BABY Divaricatori addominali	469	HARTMANN Speculi nasali	661, 662
GOURDET Curette uterine	924	HARTMANN Uncini auricolari	731
GRAEFE Bisturi per dissezione	51	HARTMANN-HALLE Speculi nasali	661
GRAEFE Divaricatori	429, 431	HARTMANN-HOFFMANN Pinze auricolari	733
GRAEFE Forbici fine per chirurgia	129	HARTMANN-NOYES Pinze auricolari	733
GRAEFE Pinze per afferrare tessuti	209	HARTMANN-WEINGAERTNER Pinze auricolari	733
GRAEFE Pinze per iridectomia	197, 208	HARTMANN-WULLSTEIN Pinze auricolari	732
GRAEFE Pinza per afferrare la pelle	686	HARVEY Forbici taglia cavo	148
GRAHAM Uncini per dura-madre	554	HARVEY-JACKSON Divaricatori, autostatici	463
GRAVE Speculi vaginali	883, 884, 886, 887	HASLINGER Divaricatore per velo pendulo	627
GRAY Pinze per preparazioni e legature	280	HASOBUCCHI Forchetta	706
GREEN-ARMYTAGE Pinza emostatiche	936	HATFIELD Curette per ossa	1112, 1113
GREGORY Pinze vascolari atraumatiche	326	HAYES Pinze per anastomosi del retto	857
GREGORY SCT Forbici per Face-lift	190	HEANEY Pinze per isterectomia	274
GREGORY TC Forbici per Face-lift	175	HEANEY Portaghi	492
GREGORY-SOFT Clamps Bulldog	297	HEANEY TC Portaghi	526
GREVEN Micropinze per piegare fili metallici	741	HEANEY-RAZAK Pinze per isterectomia	274
GREY-TURNER Pinze emostatiche	256	HEANLEY Pinze per ossa	1127
GRONINGEN Uncini per dura-madre	554	HEART-GATE Ago della cardioplegia	823
GROSS Anse auricolari	730	HEART-GATE Divaricatori costali	791, 792
GROSS Pinze per medicazione	350, 351	HEART-GATE Gancio atriale	792, 793



HEART-GATE Magnete di barra	822	I	
HEART-GATE Manici per bisturi	823	I.M.A. Divaricatori mammaria	794-797
HEART-GATE Pinza di inserimento valve atriali	820	INGE Separatori per vertebre	592
HEART-GATE Porta-legature	822	Insufflatore d'aria	716, 717
HEART-GATE Righello del suturare	823	Insufflatore	718
HEART-GATE Strumenti per miniinvasiva chirurgia	818-823	IOWA Ago per iniezione	72
HEART-GATE Supporto valve atriali	820	IOWA Pinze per abbassare il collo dell'utero	905
HEART-GATE Unicini pere nervi e vasi	822	IRIS Forbici fine per chirurgia	127-129, 157
HEART-GATE Valve atriali	820	IRIS SCT Forbici fine per chirurgia	191
HEATH Forbici per legature	147	IRIS TC Forbici fine per chirurgia	178
HEATH Martelli	1015	Irrigatori	1215
HEGAR Dilatatori uterini	897, 898	IRWIN Divaricatori, autostatici	456
HEGAR Portaghi	488	ISRAEL Divaricatori	380
HEGAR TC Portaghi	521	Isterometri	899
HEGAR-BAUMGARTNER Portaghi	490	ITERSON Uncini tracheali	655
HEGAR-BAUMGARTNER TC Portaghi	524	IVES-FANSLER Anoscopi	863
HEGAR-VASCULAR TC Portaghi	532	J	
HEGEMANN-DIETRICH Forbici vascolari	137, 158	JABALEY Forbici fine per chirurgia	130, 157
HEGEMANN-DIETRICH SCT Forbici vascolari	191	JACKSON Pinza passa tendine	1150
HEGEMANN-DIETRICH TC Forbici vascolari	180	JACKSON Speculi vaginali	893
HEGENBARTH Pinze per applicare le agrafe	517	JACKSON Uncini tracheali	656
HEIFETZ Spatole cerebrali	543	JACKSON-BURROWS Divaricatori, autostatici	457
HEIMING Pinze per nefrostomia	874	JACOBS Pinze per abbassare il collo dell'utero	906
HEISS Pinze emostatiche	244, 256	JACOBSON Bisturi per vasi	827, 838
HEISTER Apribocca	603	JACOBSON Curette per ossa	1091
HELFFERICH-BIER Seghe per amputazione e resezione	1009	JACOBSON Punzone per sutura	827, 828
HEMINGWAY Curette per ossa	1093	JACOBSON Sond doppia	827
HENDERSON Divaricatori, autostatici	449	JACOBSON Sonda bottonuta	827, 828
HENKE Dissettori per tonsille	622	JAEGER Pinze da presa per menisco e cartilagine	1145
HENLEY Divaricatori, autostatici	450, 451	JAEGER Pinza passa tendine	1151
HENLEY Pinze vascolari atraumatiche	331	JAMESON Calibro	22
HENNIG Apri gesso	1193	JAMESON Forbici per dissezione	114, 155
HEPP-SCHIEDEL Micro-forbici	143	JAMESON Portaghi	492
HERBERHOLD Abassalingua	616	JAMESON SCT Forbici per dissezione	189
HERMANN Martello	751	JAMESON TC Forbici per dissezione	172
HERMANN Scalpelli	751	JANET Siringhe	75,76
HERMANN Sgorbia	751	JANSEN Curette auricolari	730
HERRICK Pinze per peduncoli renali	283	JANSEN Curette per ossa	1091, 1092
HERTZLER Divaricatori costali	780	JANSEN Divaricatori, autostatici	446
HERZ Pinze da presa per menisco e cartilagine	1145	JANSEN Lampade frontali	27
HERZ Pinze passa tendine	1150	JANSEN Periostotomi	1060, 1064
HESS Clamps Bulldog	292	JANSEN Pinze auricolari e nasali	222
HEY-GROVES Tenaglie per ossa	1123	JANSEN Pinze per ossa	1129, 1130
HEYMANN Forbici nasali	120, 156	JATHO Pinze naso-faringe	631
HEYMANN Pinze per setto nasale	696	JAVID Pinze vascolari atraumatiche	326, 327
HEYMANN SCT Forbici nasali	190	JENNINGS Apribocca	605
HEYMANN-KNIGHT Pinze per tamponi e polipi nasali	670	JIKEI Pinze nasali	759, 760
HEYWOOD-SMITH Pinze per polipi e ovaie	357	JOBSON-HORNE Portacotone	65
HIBBS Osteotomi	1038	JOHN-HOPKINS Clamps Bulldog	292, 293
HIBBS Scalpelli	1038	JOHN-HOPKINS Pinza per applicare le pinze bulldog	293
HIBBS Sgorbie	1039	JOHNS-HOPKINS Pinze per preparazioni e legature	281
HIRSCHMANN Anoscopi	863	JONES Pinze fissatele	369
HOEN Dissettori per la dura-madre	551	JORGENSON Forbici vascolari	132
HOEN Periostotomi	1068	JOSEPH Coltelli per plastica nasale	672, 673
HOEN Pinze per laminectomia	1007	JOSEPH Coltelli per setto nasale	673
HOEN V. EICKEN Portalegature	627	JOSEPH Divaricatori	443
HOESEL Divaricatori	408	JOSEPH Elevatori per il setto nasale	677
HOESEL TC Portaghi	530	JOSEPH Forbici fine per chirurgia	123
HOFF Pinze fissatele	369	JOSEPH Periostotomi	1053
HOHMANN Leve per ossa	1077-1079	JOSEPH Raspe nasali	1084
HOKE Osteotomi	1037	JOSEPH SCT Forbici fine per chirurgia	190
HOLINGER Laringoscopi per operazione	641	JOSEPH Seghe nasali	685
HOLSHER Separatori pr le radici dei nervi	553	JOSEPH TC Forbici fine per chirurgia	177
HOLZBACH Divaricatori addominali	475	JOSEPH TC Forbici per dissezione	172
HOLZBACH Pinze emostatiche	258	JOSEPH-MASING Elevatori per il setto nasale	677
HOLZHEIMER Divaricatori, autostatici	445	JUDD-ALLIS Pinze da presa per intestino e tessuti	365
HOPKINS Coltelli per gessi	1195	JUDD-MASSON Divaricatori vescicali	952
HORSLEY Separatori pr le radici dei nervi	552	JUERS Micropinze per piegare fili metallici	742
HOUSE Cucchia taglienti	751	JURASZ Pinze naso-faringe	631
HOUSE Microaghi	748	JURASZ Pinze per polipi laringei	634
HOUSE Periostotomo	747	K	
HOUSE Tubi aspirazione	86	KABIERSKE Insufflatore	718
HOUSE Uncini tracheali	656	KADER Divaricatori	425
HOUSE-DIETER Pinze per la testa del martelletto	742	KAHN Forbici per Face-lift	117
HOWARTH Elevatori per il setto nasale	678	KALLMORGEN Speculi vaginali	891
HUBER Manico universale	636, 923	KALT Portaghi	497
HUDSON Trapani a mano per ossa	1172	KANE Clamp ombelicale	937
HUGHES Uncino per staffa	747	KANTROWITZ Pinze per preparazioni e legature	266
HUMBY Dermotomi	59	KARLIN-CRANK Divaricatori per laminectomi	588
HUNTER Pinze per schegge	225	KATSCH Tiracomedoni	61
HURD Aghi per sutura del palato	626	KATZIN Micro-forbici	142
HURD Dissettori per tonsille	622	KATZIN-BARRAQUER Micro-forbici	142
HUSFELDT Pinze vascolari atraumatiche	327	KAYE Forbici per Face-lift	118

KAYE TC Forbici per Face-lift	175	KRAUSE Tre quarti per puntura del seno mascellare	71
KAYE-MILLARD Divaricatori	444	KRAUSE-VOSS Serranodi auricolari	738
KELLY Divaricatori	406, 412, 413, 485	KRAUSE-VOSS Serranodi per polipi	671
KELLY Forbici fine per chirurgia	123, 156	KRAYENBUEHL Unicini pere nervi e vasi	829
KELLY Pinze emostatiche	249	KRESSNER Pinze per setto nasale	699
KELLY Pinze per polipi e ovaie	356	KRISTELLER Speculi vaginali	889-890
KELLY Pinze per preparazioni e legature	270	KRISTELLER WIENER Speculi vaginali	891
KELLY SCT Forbici fine per chirurgia	190	KROENLEIN Pinze emostatiche	251
KELLY Sfinteroscopi	863	KRONECKER Aghi per legatura	502
KELLY TC Forbici fine per chirurgia	177	KUEHNE Pinze porta-lamelle	226
KELLY-RANKIN Pinze emostatiche	247	KUEMMEL Divaricatori	401, 424
KELMAN-MC PHERSON Micro-pinze	227	KUESTNER Pinze per abbassare il collo dell'utero	904
KERN-LANE Tenaglie per ossa	1119, 1121	L	
KERPEL Curette per ossa	1114	LA FORCE Adenotomi	630
KERRISON Pinze per laminectomia	958, 976, 977	LA GRANGE Forbici per gengiva	124
KERSTING Pinze per anastomosi del retto	858	LABORDE Dilatatori per tracheotomia	654
KEVORKIAN Curette per biopsia	912	LACK Abassalingua	601
KEVORKIAN Pinze per la biopsia cervicale e da prelievo	920, 922	LAHEY Divaricatori	438
KEVORKIAN-PACIFIC Pinze per la biopsia cervicale e da prelievo	921	LAHEY Pinza da presa per gozzo	657
KEY Periostotomi	1068	LAHEY Pinze per abbassare il collo dell'utero	908
KEYES Trefine cutanee	60	LAHEY Pinze per preparazioni e legature	280, 281
KIELLAND Pinza obsterica	933	Lama del tumore	836, 837
KILLIAN Cesoia per setto nasale	700	LAMBERT-KAY Pinze vascolari atraumatiche	330
KILLIAN Elevatori	1055	LAMBOTTE Divaricatori	378
KILLIAN Elevatori per il setto nasale	678	LAMBOTTE Osteotomi	1034
KILLIAN Periostotomi	1055	LAMBOTTE Periostotomi	1065
KILLIAN Pinze per tamponi e polipi nasali	670	LAMBOTTE Tenaglie per ossa	1124, 1125
KILLIAN Portacotone	633	Lame per bisturi	48, 50
KILLIAN Sgorbie	679	Lamette di rasoio	47, 1207
KILLIAN Speculi nasali	663-666	Lampade frontali	26-27
KILLIAN-CLAUS Sgorbie	679	Lancetta pungidito	29
KILLIAN-RUDERT Speculi nasali	665	LANDAU Speculi vaginali	893
KILNER (RAGNELL) Forbici per dissezione	113, 155	LANDAU Tre quarti	71
KILNER Divaricatori	419, 439, 442	LANDOLT Curetta	706
KILNER Forbici fine per chirurgia	126	LANDOLT Curetta	706
KILNER Portaghi	491	LANDOLT Enuclatore	706
KILNER TC Forbici per dissezione	172	LANDOLT Forbici nasali	121
KILNER TC Portaghi	525	LANDOLT Manici per bisturi	826
KILNER Uncino per ali nasali	688	LANDOLT Periostotomi	562
KILNER-DOUGHTY Apribocca	613	LANDOLT Pinza divaricatore per speculum	702
KIRK Martelli	1017	LANDOLT Pinze per laminectomia	1005
KIRKLIN Divaricatori	438	LANDOLT Uncini	706
KIRSCH Divaricatori	388	LANDOLT-REULEN Curetta	708
KIRSCHNER Archi oer trazione	1154, 1155	LANDOLT-REULEN Dissettori	708
KIRSCHNER Divaricatori addominali	472, 473	LANDOLT-REULEN Periostotomo	708
KIRSCHNER Sonda conduttrici	510, 511	LONDON Speculi vaginali	892
KLAPP Divaricatori	433	LANE Leve per ossa	1076
KLEINERT-KUTZ Divaricatori	444	LANE Pinze fissatele	368
KLEINERT-KUTZ Pinze passa tendine	1152	LANE Pinze intestinali	853
KLEINERT-KUTZ Pinze per ossa	1127, 1132	LANE Pinze per chirurgia	215
KLEINSCHMIDT Pinze intestinali	852	LANE-TRETHOWAN Leve per ossa	1076
KLIMA-ROSEGGER Aghi per la puntura dello sterno	73	LANGE Divaricatori	436
KLINKENBERGH-LOTH Forbici vascolari	131	LANGE Forbici per bendaggi	1186
KNAPP Divaricatori	432	LANGE Pinze per Broncho-esofagoscopia	637
KNIGHT Forbici nasali	121	LANGE-HOHMANN Leve per ossa	1079, 1080
KNIGHT Pinze per setto nasale	696	LANGENBECK Anse auricolari	728
KNIGHTON Separatori per vertebre	593	LANGENBECK Coltelli per amputazione	52
KNOWLES Forbici per bendaggi	1186	LANGENBECK Coltelli per resezione	53
KOCHER Aghi per legatura	502	LANGENBECK Divaricatori	381-383
KOCHER Divaricatori	376, 392, 399, 404	LANGENBECK Elevatori	1074
KOCHER Pinze emostatiche	254, 255	LANGENBECK Periostotomi	1064
KOCHER Pinze intestinali	846, 848	LANGENBECK Protettore per dita	619
KOCHER Sonda per gozzo	657	LANGENBECK Seghe per amputazione e resezione	1010
KOCHER Spatole vescicali	953	LANGENBECK TC Portaghi	531
KOCHER-LANGENBECK Divaricatori	389, 390	LANGENBECK Tenaglie per ossa	1118
KOCHER-WAGNER Divaricatori	405	LANGENBECK-RYDER TC Portaghi	534
KOELNER Agrafes emostatici per cuoio capelluto	546	LANGE-WILDE Serranodi auricolari	738
KOENIG Diapason	714	LANGE-WILDE Serranodi per polipi	671
KOENIG Divaricatori	437	LANG-STEVENSON Pinze intestinali	852
KOENIG Elevatori	1052	Laringologia	652, 653
KOENIG Periostotomi	1053	Laringoscopi di luce fredda ed accessori	40-41, 43
KOENIG Sonda conduttrici	512	Laringoscopi ed accessori	36-43
KOERTE Divaricatori	379	Laringoscopi per operazione	638-641
KOERTE Divaricatori	424	LAWRENCE Pinze per preparazioni e legature	264
KOGAN Endospeculi	896	LEBSCHKE Guida per fili per sega	549
KONRICH Scatole per sterilizzare bendaggi	1224	LEBSCHKE Scalpello per sterno	764
KOOS Bisturi per vasi	838	LEES Pinze vascolari atraumatiche	314, 323
KRAEMER Divaricatori	388	Legatore emorroidale	866-868
KRAEMER Periostotomi	1063	LEGUEU Divaricatori vescicali	952
KRAUS Bisturi per vasi	838	LEGUEU Spatole vescicali	953
KRAUSE Pinze per Broncho-esofagoscopia	637	LEKSELL Pinze per ossa	1137
KRAUSE Serranodi auricolari	738	LEKSELL-STILLE Pinze per ossa	1137
KRAUSE Serranodi per polipi	671	LELAND-JONES Pinze vascolari atraumatiche	317-319



LEMPERT Curette per ossa	1098	LUER-LOCK Siringhe	74,76
LEMPERT Elevatori	737	LUER-STILLE Pinze per ossa	1138, 1139
LEMPERT Periostotomi	1054	LUIKART-BILL Fermapinza	936
LEMPERT Tubi aspirazione	80	LUKENS Uncini tracheali	656
Lenti auricolari	726, 727	LUNIATSCHEK Portatampone	626
Lenti dingrandimento	23	LURZ Pinze per calcoli biliari	877
LERCHE Pinze per chirurgia	218	M	
LERICHE Divaricatori	423	M.G. HOSPITAL Portaghi	489
LERICHE Pinze emostatiche	247, 257	MAGILL Pinze introduttrici di cateteri	944
Leva auricolare	730	MAGILL Tubi aspirazione	79
Leva ostetrica	936	Maglia metallica	1155
Leva per corpi estranei	731	Magnete di barra	822
Leva per lussazione	1083	MAINGOTT Pinze per isterectomia	275
Leve per ossa	1075-1083	MALTZ Raspe nasali	1085, 1087
LEWIN Pinze per riposizioni	1116	Mani di piombo	1182
LEWIS Raspe nasali	1084	Manici per bisturi	44-47, 50, 823, 825, 826
LEWKOWITZ Pinze per calcoli	945	Manico a trazione	936
LEXER Forbici per dissezione	112, 155	Manico ad uncino per fili per sega	1010
LEXER Osteotomi	1043, 1047	Manico per aspirazione	85
LEXER Scalpelli	1042	Manico per pila per laringoscopi	42-43
LEXER SCT Forbici per dissezione	188	Manico universale	636, 923
LEXER Sgorbie	1043, 1044, 1048	MANNERFELT Divaricatori	1178-1180
LEXER Sgorbie per tessuto osseo spugnoso	1045, 1048	MANNERFELT Osteotomi	1181
LEXER TC Forbici per dissezione	171	MANNERFELT Periostotomi	1180, 1181
LEXER-BABY Forbici per dissezione	112	MANNERFELT Sgorbie	1181
LEXER-MINI Osteotomi	1041	Marcatori per areola	21
LEXER-MINI Sgorbie	1041	MARKWALDER Pinze per ossa	1139
LEYLA Autofissatore per retrattori, per il supporto del craino	540-542	MARQUARDT Pinze per ossa	1133
LICHTENBERG Portaghi	497	MARSCHIK Pinze per tonsille	620
LICHTENBERG TC Portaghi	530	MARSCHIK-KRONE Pinze per tonsille	621
LICHTWITZ Tre quarti per puntura del seno mascellare	70, 87	Martelli	751, 1013-1020
Lima per cute ispessita	1207	Martelli percussori	16, 17
Lime per unghie	1206	MARTIN Coltelli per gessi	1195
LISTER Candeleterie dilatatrici	950	MARTIN Divaricatori	375, 377
LISTER Forbici per bendaggi	1187	MARTIN Divaricatori	414
LISTER Forbici per bendaggi e gessi	1190	MARTIN Forbici per cartilagini	116
LISTER Pinze per seni	352	MARTIN Isterometri	899
LISTON Cesioie per ossa	1141-1143	MARTIN Pelvimetro	931
LISTON Coltelli per amputazione	52	MARTIN Pinze da presa per menisco e cartilagine	1146
LISTON-KEY Cesioie per ossa	1144	MARTIN Pinze per medicazione	351
LISTON-STILLE Cesioie per ossa	1143	MARTIN Pinze per rifiuti	1218
LITTAUER Forbici per legature	147	MARTIN Portacotone	65
LITTAUER Pinze per ciglia	223	MARTIN Seghe per aprire anelli	1011
LITTAUER Pinze per polipi auricolari	732	MARTIN-CUSHING Periostotomi	1071
LITTAUER Pinze per tamponi e polipi nasali	670	MARTINI Curette per ossa	1091
LITTLE Divaricatori	438	MARTIN-LANGENBECK Periostotomi	1071
LITTLER Forbici fine per chirurgia	126	MASING Coltelli per scalfire la cartilagine	672
LITTLER Forbici per legature	147	MASING Divaricatori nasali	690
LITTLEWOOD Pinze da presa per intestino e tessuti	365	MASING Elevatori per il setto nasale	677
LLOYD-DAVIES Forbice per dissezione rettale	106	MASING Pinze auricolari	734
LLOYD-DAVIES Pinze per anastomosi del retto	856	MASSON Portaghi	493
LOCKHART-MUMMERY Sonda	64	MASSON TC Portaghi	527
LOCKLIN Forbici vascolari	133	MASSON-LUETHY Portaghi	494
LOCKLIN TC Forbici per gengiva	178	MASTIN Pinza muscolare	657
LOCKWOOD Pinze da presa per intestino e tessuti	362	MATHIEU Dilatatori per l'ano ed il retto	861
LOCKWOOD-ALLIS Pinze da presa per intestino e tessuti	365	MATHIEU Divaricatori	418
Lombare microdissectomia divaricatori Set	583	MATHIEU Pinze per corpi estranei	948
LOPEZ-REINKE Dissettori per tonsille	622	MATHIEU Portaghi	496
LORENZ Forbici per bendaggi e gessi	1190	MATHIEU Speculi vaginali	892
LORNA (EDNA) Pinze fissatele	369	MATHIEU TC Portaghi	528, 529
LOUTE Strumenti per cerchiaggio	1158	MATHIEU-RYDER TC Portaghi	534
LOVE Divaricatore per velo pendulo	627	MATZENAUER Speculi vaginali	892
LOVE Separatori pr le radici dei nervi	551, 552, 553	MAUNDER Apribocca elicoidale	619
LOVE-GRUENWALD Pinze per laminectomia	996	MAXIMUS Sfigmomanometri	24
LOVELACE Pinze per afferrare polmone	801	MAYFIELD Pinze per ossa	1132
LOWER Pinze per preparazioni e legature	281	MAYO Cucchiari per calcoli biliari	874
LOWMAN Tenaglie per ossa	1126	MAYO Forbici per chirurgia	103, 152
LOWMAN-HOGLUND Tenaglie per ossa	1126	MAYO Pinze per sterilizzazione	372
LUBET-BARBON Pinze per tamponi e polipi nasali	669	MAYO SCT Forbici per chirurgia	186
LUC Pinze per setto nasale	697	MAYO Spatole per lingua	600
LUCAE Aghi per paracentesi	737	MAYO TC Forbici per chirurgia	165
LUCAE Diapason	713, 714	MAYO TC Forbici per legature	181
LUCAE Divaricatori	429	MAYO-ADAMS Divaricatori, autostatici	449
LUCAE Martelli	1016	MAYO-BLAKE Pinze per calcoli biliari	877
LUCAE Pinze auricolari e nasali	221, 222	MAYO-GUYON Pinze per peduncoli renali	285
LUCAS Curette per ossa	1091	MAYO-HARRINGTON Forbici per chirurgia	105, 153
LUER Cannule tracheali	654	MAYO-HARRINGTON SCT Forbici per chirurgia	186
LUER Divaricatori	419	MAYO-HARRINGTON TC Forbici per chirurgia	165
LUER Pinze da presa per intestino e tessuti	366	MAYO-HEGAR Portaghi	488, 489
LUER Pinze per ossa	1128, 1130	MAYO-HEGAR TC Portaghi	521
LUER Siringhe	74	MAYO-LEXER TC Forbici per dissezione	171
LUER-FRIEDMANN Pinze per ossa	1127	MAYO-NOBLE Forbici per chirurgia	105
LUER-KOERTE Cucchiari per calcoli biliari	873	MAYO-ROBSON Pinze intestinali	850



MAYO-RUSSIAN Pinze per afferrare tessuti	203	MILLIN Pinze per prendere capsule	955
MAYO-STILLE Forbici per chirurgia	104, 153	MILLS Forbici vascolari	137
MAYO-STILLE SCT Forbici per chirurgia	187	MINI-HOHMANN Leva per ossa	1075
MAYO-STILLE TC Forbici per chirurgia	167	MINI-LAMBOTTE Osteotomi	1030, 1031
MC CLINTOCK Pinze per placenta e per ovaie	940	MINI-LANGENBECK Divaricatori	439
MC CLURE Micro-forbici	138	MINIMUS Sfigmomanometri	24
MC CULLOCH Divaricatori per laminectomi	586, 587	MINI-OLSEN Portaghi con forbici	495
MC DONALD Periostotomi	1055	MINI-ROUX Divaricatori	417
MC GEE Micropinze per piegare fili metallici	741, 744	MINI-TOWNSEND Pinze per la biopsia cervicale e da prelievo	922
MC GEE Uncino	750	Mini-transformatore	27
MC GIVNEY Legatore emorroidale	868	MINI-VANNAS Micro-forbici	138
MC GLAMRY Periostotomi	1068	Miringotomo	735
MC INDOE Divaricatori	443	MISKIOM Divaricatori, autostatici	454
MC INDOE Forbici per cartilagini	115	Misuratori	22
MC INDOE Osteotomi	684	MIXTER Forbici per chirurgia	97
MC INDOE Pinze anatomiche per dissezione	199	MIXTER Pinze per calcoli biliari	878
MC INDOE Pinze per chirurgia	211	MIXTER Pinze per preparazioni e legature	268, 280
MC INDOE TC Pinze anatomiche per dissezione	232	MIXTER-O'SHAUGNESSY Pinze per preparazioni e legature	281
MC INTOSH Laringoscopi	38	MOCK Ago per eparina	73
MC INTOSH Laringoscopi di luce fredda	40	MOELTGENGoniometro	20
MC IVOR Abassalingua	616	MOLDENHAUER Leva auricolare	730
MC IVOR Apribocca	614	MOLDESTAD Divaricatori	433
MC KENTY Elevatori per il setto nasale	676, 677	MOLLISON Divaricatori, autostatici	447
MC KENZIE Agrafes di argento	546	MOLT Apribocca	603
MC KENZIE Pinze per applicare le agrafe	547	MOLT Periostotomi	1054
MC KENZIE Supporto porta-agrafes	546	MOORE Cucchiato per colecisti	873
MC KESSON Apribocca elicoidale	619	MOORE Trapani a mano per ossa	1171
MC QUIGG-MIXTER Pinze vascolari atraumatiche	300	MOORFIELD Pinze per sutura	198
MEAD Martelli	1013	MORGAN Proctoscopi	864
MEAD Pinze per ossa	1130	MORITZ-SCHMIDT Abassalingua	601
Meatotomo	948	MORRIS Divaricatori	401
MEEKER Pinze per preparazioni e legature	266	MORRIS-DE BAKEY Pinze vascolari atraumatiche	324
MEMORY Spatole cerebrali	544	MORSE Divaricatori costali	775, 778, 779
MENGHINI Aghi per la puntura cieca del fegato	74	MORSE-FAVALORO Divaricatori costali	778
MERCEDES Divaricatori costali	790	MOSHER-BRUENINGS Tubo di intubazione	653
Metro a nastro	21	MOSQUITO-DANDY Pinze emostatiche	248
METZENBAUM Forbici per dissezione	108-111, 154	MOYNIHAN Pinze per isterectomia	273
METZENBAUM Portaghi	489	MOYNIHAN Sonda per calcoli biliari	872
METZENBAUM SCT Forbici per dissezione	187, 188	MUCK Coltello periostio	735
METZENBAUM TC Forbici per dissezione	167-170	MUEHLING Periostotomi	562
METZENBAUM TC Forbici per legature	181	MUELLER Divaricatori, autostatici	445
METZENBAUM-BABY Forbici per dissezione	111, 155	MUELLER Pinze per anastomosi del retto	858
METZENBAUM-LAHEY TC Forbici per dissezione	173	MUENCHEN Curette per biopsia	913
MEYER Pinze per riposizioni	1116	MURPHY Fascia frontale	35
MEYERDING Divaricatori	407, 441, 486	MURPHY-LANE Leva per lussazione	1083
MEYERDING Divaricatori, autostatici	452	MUSEUX Pinze per abbassare il collo dell'utero	905, 906, 908
MICHEL Agrafe da sutura	516	MUSGROVE Ago per cerume e portagarze	730
MICHEL Pinze per applicare le agrafe	517	MYLES Pinze nasali	990
MICHEL Specchi per rinoscopia	632	N	
MICK Forbici per bendaggi e gessi	1188, 1189	NABATOFF Set di sonde per varici	806
MICRO-ADSON Pinze emostatiche	245	NAEGELE Pinza obsterica	932
Microaghi	748, 749, 752, 753	NAGER Divaricatore per velo pendulo	627
Microbisturi	745	NEFF Bisturi per menisco	1146
Microchirurgia endolaringea	642-651	NEGUS (GUEDEL) Laringoscopi	36
Micro-dissettore	814	NEGUS Coltelli per vegetazioni adenoidee	629
Micro-forbici	138-143	NEGUS Pinze per peduncoli renali	282
Microforbici da presa	644, 646, 651	NEGUS Supporto sternale per tutti gli apribocca	617
MICRO-MOSQUITO Pinze emostatiche	250, 259	NEIVERT Portaghi	491
Micro-pinze	226-228	NEIVERT Uncino per ali nasali	690
Micropinze a cucchiaino	642, 647-651	NEIVERT-ANDERSON Osteotomi	683
Micropinze con morsi a cucchiaino	739, 743	NEIVERT-MASING TC Portaghi	524
Micropinze da presa	642-643, 646, 649-651	NÉLATON Sonda scanalate	63
Micropinze per piegare fili metallici	741, 742, 744	NELSON Pinze per afferrare polmone	216
Microportaghi	643, 644	NELSON Tre quarti	69
MICRO-RYDER TC Portaghi	532	Neurochirurgia	537-594
Microuncini	749	NEW ORLEANS TC Portaghi	526
MICRO-VASCULAR TC Portaghi	532	NEWS Uncini tracheali	656
MIDDELDORPF Divaricatori	400	Nexessario per infermiera	1207
MIDDLETON-JANSEN Pinze per setto nasale	699	NICOLA Curetta	704
MIKULICZ Divaricatori	392, 393	NICOLA Microforbici da presa	651
MIKULICZ Pinze per peritoneo	277-279	NICOLA Micropinze a cucchiaino	651
MILAN Curette per biopsia	914	NICOLA Periostotomo	704
MILIGAN Divaricatori, autostatici	449	NIEDERDELLMANN Osteotomi	1038
MILLARD (COTTLE) Uncino nasale ad anello	689	NISSEN Pinze emostatiche	243
MILLER Curette per ossa	1092	NORFOLK & NORWICH Divaricatori, autostatici	453
MILLER Laringoscopi	37	NOTO Pinze per polipi e ovaie	357
MILLER Laringoscopi di luce fredda	41	NOTT Speculi vaginali	883
MILLER Raspe nasali	1087	NOVAK Curette per biopsia	912
MILLER-COLBURN Curette per ossa	1094	NOYES Micro-forbici	140
MILLER-COLBURN Raspe nasali	1088	NUBOER Tubi aspirazione	78
MILLIGAN Dissettori per la dura-madre	550	NUSSBAUM Pinze intestinali	849
MILLIN Dilatatore per collo vescicale	953	O	
MILLIN Divaricatori vescicali	952	O'BRIEN Forbici fine per chirurgia	128



OBWEGESER Aghi per legatura	501	PERKINS Divaricatori, autostatici	1058-1071
OBWEGESER Divaricatori per tessuti molli	384, 385	PERTHES Puteruoli	448
OBWEGESER Elevatori	1056	PESTALOZZA Cucchiari per placenta e per ovaie	1012
OBWEGESER Guancio per mento	383, 1057	PETZ Pinze per intestino e stomaco	942
OBWEGESER Osteotomi	1035, 1036	PHANEUF Pinze per isterectomia	860
OBWEGESER Osteotomi a forma di cuneo	1035	PIERCE Elevatori per il setto nasale	273
OBWEGESER Osteotomi a forma di lama	1035	PIERCE Tre quarti per puntura del seno mammellare	676
OBWEGESER Osteotomi fenditori	1035	Pietra per affilare	70
OBWEGESER Osteotomi interdentali	1036	PINARD Stetoscopi fetali	58
OBWEGESER Periostotomi	1058, 1059	Pinza da presa per gozzo	17
OBWEGESER Raspe	1088	Pinza di fissaggio	657
OBWEGESER Separatore per il dente del giudizio	387	Pinza di inserimento valve atriali	686
OBWEGESER Separatore per ramo	386	Pinza divaricatore per speculum	820
OBWEGESER Separatori mandibulari	1057	Pinza emostatiche	702
OCHSNER Pinze anatomiche per dissezione	203	Pinza muscolare	936
OCHSNER Pinze vascolari atraumatiche	331	Pinza osterica	657
OCHSNER Sonde per calcoli biliari	873	Pinza per afferrare la pelle	932-935
OCHSNER Tre quarti per vescia biliare	71	Pinza per applicare le pinze bulldog	686
OCHSNER-KOCHER Pinze emostatiche	252, 253	Pinza per columella	293, 296
O'CONNOR Divaricatori	431	Pinza per formare osso	686
OKONEK-YASARGIL Punzone per tumore	828	Pinza per il cuoio cappelluto	1118
OLDBERG Pinze per laminectomia	1005	Pinza per introduzione per protesi in teflon	936
OLIVECRONA Bisturi per nervo trigemino	57	Pinza per rotula	742
OLIVECRONA Dissettori per la dura-madre	550	Pinza per trazione craniale	1117
OLIVECRONA Fili per sega	1010	Pinza vascolare e per tumori	548
OLIVECRONA Forbici nasali	120	Pinze	214, 216, 218
OLIVECRONA Pinze per ossa	1131	Pinze anastomosi	194-229
OLIVECRONA Spatole cerebrali	544	Pinze anatomiche per dissezione	845
OLIVECRONA-TOENNIS Pinze per applicare le agrafe	547	Pinze atraumatiche	194-204
OLLIER Divaricatori	380	Pinze auricolari	218-220
OLSEN-HEGAR Portaghi con forbici	495	Pinze auricolari e nasali	732-734
OLSEN-HEGAR TC Portaghi	527	Pinze con morsi in carburo di tungsteno	221, 222
OMBREDANNE Martelli	1015	Pinze da presa	232-236
O'SHAUGNESSY Pinze per preparazioni e legature	281	Pinze da presa per intestino e tessuti	204
Osteotomi	680-684, 1021, 1026-1051	Pinze da presa per lingua	360-366
Osteotomi a forma di cuneo	1035	Pinze da presa per menisco e cartilagine	618
Osteotomi a forma di lama	1035	Pinze emostatiche	1145, 1146
Osteotomi fenditori	1035	Pinze fissatele	238-260
Osteotomi interdentali	1036	Pinze guida sonda	367-369
O'SULLIVAN - O'CONNOR Speculi vaginali	895	Pinze intestinali	1012
O'SULLIVAN-O'CONNOR Divaricatori addominali	476	Pinze introduttrici di cateteri	844-854
OTIS Uretrotomo	954	Pinze microauricolari	944
Otoscopi	599, 712	Pinze nasali	739, 743
OVERHOLT Pinze per preparazioni e legature	261, 262	Pinze nasali per biopsia	756-760, 988-994
OVERHOLT-GEISSENDOERFER Pinze per preparazioni e legature	260	Pinze naso-faringe	755
OVERHOLT-MIXTER Pinze per preparazioni e legature	268	Pinze orologio	631
P		Pinze passa tendine	228
PACHON Sfigmomanometri	24	Pinze per abbassare il collo dell'utero	1150-1152
Padelle	1215	Pinze per afferrare	901-908
PAPAVERO-CASPAR Speculi per ipofisi sectomia	702	Pinze per afferrare e rompere le lamette de rasoio	47
PARKER Divaricatori	417	Pinze per afferrare l'utero	825
PARKER-BABY Divaricatori	417	Pinze per afferrare organi	909, 910
PARKER-KERR Pinze per anastomosi del retto	855	Pinze per afferrare polmone	358
PARKER-LANGENBECK Divaricatori	418	Pinze per afferrare tessuti	216, 801
PARKER-MOTT Divaricatori	418	Pinze per allacciare tendini	203, 204, 209, 217
PARKS Raspe nasali	1087	Pinze per anastomosi del retto	1150-1152
PARTSCH Martelli	1017	Pinze per applicare le agrafe	855-859
PARTSCH Scalpelli	1027	Pinze per ascessi tonsillari	517, 518
PARTSCH Sgorbie	1028	Pinze per biopsia rettale	623
PARTSCH-LANGE Periostotomi	1052	Pinze per bronchi	869
PASSOW Punzoni	1024	Pinze per Broncho-esofagoscopia	802
PAUL Divaricatori	444	Pinze per calcoli	636
PAYR Pinze intestinali	854	Pinze per calcoli biliari	945
PAYR Sonde conduttrici	512	Pinze per calcoli renali	877, 878
PEAN Pinze emostatiche	238-241	Pinze per chirurgia	875
PECK-JOSEPH Forbici fine per chirurgia	123	Pinze per ciglia	205-218
PEDERSON Speculi vaginali	883, 884	Pinze per corpi estranei	223
PEERS-BERTRAM Pinze fissatele	369	Pinze per etmoide	731, 948
PEET Pinze per scheggio	1208	Pinze per fissare	745
PELKMANN Pinze per medicazione	355	Pinze per frammento osseo	946
PELTESON Portacotone	633	Pinze per intestino e stomaco	1118
Pelvometro	931	Pinze per iridectomia	860
PENFIELD Dissettori per la dura-madre	812	Pinze per isterectomia	197, 208
PENNINGTON Elevatori per il setto nasale	676	Pinze per la biopsia cervicale e da prelievo	271-276, 286
PENNINGTON Pinze da presa per intestino e tessuti	362	Pinze per la testa del martelletto	916-923
PENNYBACKER Pinze per laminectomia	1004	Pinze per laminectomia	742, 744
PENNYBACKER Pinze per ossa	1131	Pinze per laminectomia, smontabile	958-987, 994-1007
PENNYBAKER Dissettori per la dura-madre	813	Pinze per malleolo	962, 966
PERCY Retrattore per amputazione	1008	Pinze per medicazione	1117
Perforatori	748	Pinze per mettere clips ETHICON	349-355
Perforatori a mano	1156, 1157	Pinze per nefrostomia	518
Perforatori per aorta	811	Pinze per ossa	874, 876
Periostotomi	562, 563, 704, 708, 752, 831, 832, 835, 1052-1055,	Pinze per ossa del cranio	1126-1140



Pinze per peduncoli renali	549	Protettore per dita	862, 864
Pinze per peritoneo	282-284	PROVIDENCE-HOSPITAL Pinze emostatiche	619
Pinze per placenta e per ovaie	277-279	Punzone per sutura	249
Pinze per polipi auricolari	939-941	Punzone per tumore	827, 828
Pinze per polipi e ovaie	732	Punzoni	828
Pinze per polipi laringei	356, 357	Puteruoli	1024
Pinze per prendere capsule	634, 635	PUTTI Raspe	1012
Pinze per preparazioni e legature	955	Q	
Pinze per rifiuti	260-270, 280-281	QUATTRO Apri gesso	1089
Pinze per riposizioni	1218	QUERVAIN Elevatori	1194
Pinze per rompere le lamette de rasoio	1115	QUINBY Forbici per gengiva	1074
Pinze per schegge	47	QUINKE Aghi per la puntura cieca del fegato	124
Pinze per scheggno	224-225	QUIRE Leva per corpi estranei	74
Pinze per seni	1208	R	
Pinze per seno frontale	352	RABINER Martelli percussori	731
Pinze per setto nasale	695	RADOLF Tronchesini per unghie	17
Pinze per sterilizzazione	696-699, 701	RAGNELL Divaricatori	1206
Pinze per strumenti sterilizzati	372	RAGNELL-DAVIS Divaricatori	419
Pinze per sutura	1209	RAKE Divaricatori	440
Pinze per tamponi	198	RALK Pinze per scheggno	486
Pinze per tamponi e polipi nasali	349-352, 354, 355	RALK Trapani a mano per ossa	1208
Pinze per tamponi e spugne	669, 670	RAMPLEY Pinze per tamponi e spugne	1172, 1173
Pinze per tonsille	359	RANDALL Curette per biopsia	359
Pinze per uretere	620	RANDALL Pinze per calcoli renali	912
Pinze per vena cava	945	RANDALL Pinze per nefrostomia	875
Pinze per vomere	347, 348	RANEY Agrafes emostatici per cuoio capelluto	876
Pinze porta cavo	696, 697	RANEY Pinze per applicare le agrafe	546
Pinze porta-lamelle	1159-1163	Raschiatoio per lupus	546
Pinze rotanti taglienti	226	Rasoi	60
Pinze serratubi	756	Raspe	58
Pinze stomaco	370-371	Raspe nasali	748, 1088, 1089
Pinze taglienti per seno mascellare	851	RAY Curetta	1084-1090
Pinze vascolari atraumatiche	693-695	RECAMIER Curette uterine	703
Pinze vascolari per neonati	299-346	Recipienti	925, 926, 928
Pinze zecca	298-299	REDON Aghi conduttori	1212-1217
PIPER Pinza obsterica	226	REICHERT Abasso epiglottide	66-68
Pistola lavatrice a getto d'acqua	934	REILL Pinze per riposizioni	633
PITHA Apribocca elicoidale	1226	REILL Tenaglie tagliafilili	1116
PITHA Pinze per medicazione	619	REINER Coltelli per gessi	1164
Placca per stendere la pelle	352	RESANO Forbice per capsula	1195
PLESTER Bisturi a falda	59	RESANO Pinze per anastomosi del retto	105
PLESTER Bisturi falciforme	745	Retratore per amputazione	859
PLESTER Divaricatori, autostatici	745	Retrattori per ginocchio	1008
PLESTER Escavatore	448	Retrattori prostatici	1148, 1149
PLESTER Forcella di guida	747	REVERDIN Aghi per legatura	953
PLESTER Raspa	747	REVERDIN Spatole addominali e intestinali	500
PLESTER Tubi aspirazione	748	REYNOLDS Forbici per dissezione	421
PLESTER Uncino	77	REYNOLDS SCT Forbici per dissezione	114, 156
PLESTER Uncino per seno mascellare	747	REYNOLDS TC Forbici per dissezione	189
POLITZER Aghi per paracentesi	747, 748	RHOTON Aghi	172, 173
POLITZER Bisturi per foruncoli	736	RHOTON Curetta	841
POLITZER Insoffiatore d'aria	735	RHOTON Dissetto	840, 841
POLITZER Specoli auricolari	716, 717	RHOTON Dissettori sferici	840
POLLOSON Divaricatori	721	RHOTON Elevatori	840
Polverizzatori	410	RHOTON Uncino	840
POOLE Tubi aspirazione	761	RIBBON-IRIS Forbici fine per chirurgia	841
POPLITEA Divaricatori addominali	82, 83	RIBBON-STEVENS Forbici fine per chirurgia	130
Portacotone	465	RICARD Divaricatori addominali	130
Portaghi	65, 66, 633, 653	RICHARDSON Divaricatori	468
Portaghi con forbici	488-499	RICHARDSON-EASTMAN Divaricatori	412
Portaghi con morsi in carburo di tungsteno	495	RICHNAU-HOLMGREN Specoli auricolari	411
Portalegature	520-535	RICHTER Forbici per chirurgia	726
Portapinze	513, 627, 815, 822	RICHTER-HEATH Pinze per applicare le agrafe	97
Portatampone	845	RIENHOFF Divaricatori costali	518
POTTS Pinze vascolari atraumatiche	626	RIGBY Divaricatori, autostatici	782
POTTS-DE MARTEL Forbici vascolari	307, 308, 315, 319, 320	Righello del suturare	458
POTTS-DE MARTEL SCT Forbici vascolari	136	RING Abassalingua	823
POTTS-SMITH Forbici vascolari	192	RI-RAP Stetoscopi	616
POTTS-SMITH Pinze anatomiche per dissezione	117, 133, 136, 158	RITTER Dilatatori per seno frontale	19
POTTS-SMITH Pinze per chirurgia	201	ROBB Dissettori vascolari	753
POTTS-SMITH TC Pinze anatomiche per dissezione	213	ROBERTS Pinze per preparazioni e legature	814
POTTS-SMITH TC Forbici vascolari	233	ROBIN MASSE Divaricatori addominali	269
POZZI Pinze per abbassare il collo dell'utero	179	ROBIN Pinze fissatele	465
PRATT Curette per seno mascellare	902	ROCHARD Divaricatori addominali	367
PRATT Dilatatori per l'ano ed il retto	690	ROCHESTER-CARMALT Pinze emostatiche	477
PRATT Pinze per abbassare il collo dell'utero	861	ROEDER Pinze fissatele	245
PRATT Pinze per peritoneo	907	ROEDER Serranodi per tonsille	368
PRATT Sonde	277	ROETTGEN-RUSKIN Pinze per ossa	627
PRECISA Sfigmomanometri	64	ROGER Elevatori per il setto nasale	1134
PRINCE Forbici per tonsille	24	ROGERS Pinze per isterectomia	676
PRINCE-THOMAS Pinze per afferrare polmone	116	ROGGE Pinze per strumenti sterilizzati	275, 276
PRINCE-THOMAS Pinze per bronchi	801	ROLLET Divaricatori	1209
Proctoscopi	802	ROSCHKE Dilatatori per l'ano ed il retto	432



ROSE Divaricatori	864	SCHNEIDER-SAUERBRUCH Periostotomi	1064
ROSEN Bisturi lanceolato	419	SCHNIDT Pinze emostatiche	1065
ROSEN Bisturi rotondi	747	SCHNIDT Pinze per tonsille	244
ROSEN Cucchiaio	746	SCHOEMAKER Pinze intestinali	620
ROSEN Gancio fenestrato	747	SCHOEMAKER-LOTH Forbici per legature	852
ROSEN Microaghi	747	SCHOENBORN Uncini tracheali	147
ROSEN Periostotomo	748, 749	SCHROEDER Bisturi per fistole	656
ROSEN Tubi aspirazione	747	SCHROEDER Curette uterine	56
ROSER-KOENIG Apribocca	85	SCHROEDER Pinze per abbassare il collo dell'utero	924
ROSS Divaricatori per aorta	604	SCHUBERT Pinze per la biopsia cervicale e da prelievo	901, 903, 907
ROUX Divaricatori	816	SCHUHKNIGHT Strumento curvo per modellare fili guida	916, 917
ROUX-MAGNUS Divaricatori	416	SCHUHKNIGHT Tubi aspirazione	686
RUBIN Osteotomi	417	SCHUHKNIGHT Bisturi a rullo	89
RUBIN Pinze per setto nasale	681	SCHUHKNIGHT Bisturi falciforme	746
RUDD Legatore emorroidale	701	SCHUHKNIGHT Micropinze per piegare fili metallici	746
RUMEL Pinze per preparazioni e legature	867	SCHUL Divaricatori per disco intervertebrale	741
RUMEL-BELMONT Porta-legatur	267	SCHULTZE Salpingografo	594
RUMEL-BELMONT Strumenti per varici	815	SCHUMACHER Costotomi	915
RUSKIN Pinze per ossa	815	SCHUMACHER Forbici ombelicali	764
RUSKIN Tre quarti per puntura del seno mascellare	1133	SCHUMACHER Pinze per Broncho-esofagoscopia	102
RUSKIN-LISTON Cesoie per ossa	87	SCHUMACHER Pinze per la biopsia cervicale e da prelievo	637
RUSSEL-DAVIS Abassalingua	1142	SCHUMACHER-VAN DOREN Pinze per la biopsia cervicale e da prelievo	920
RUSSIAN Pinze per afferrare tessuti	615	SCHWEDEN Curette per ossa	918
RUST Seghe per amputazione e resezione	203	Scodella di Petri	1091
RYDEL-SEIFFER Diapason	1009	Scodelle rotonde	1214
RYDER Portaghi	713	SCOVILLE Curette per ossa	1212, 1214
RYDER-VASCULAR TC Portaghi	498	SCOVILLE Divaricatori	1106
S		SCOVILLE Divaricatori per laminectomi	486
SAALFELD Tiracomedoni	532	SCOVILLE Separatori per le radici dei nervi	558
SACHS Dissettori per la dura-madre	61	SCOVILLE Valve laterale	552
SACHS Uncini per dura-madre	550, 551	SCOVILLE-HAVERFIELD Divaricatori per laminectomi	557, 558
SACHSE Meatotomo	554	SCOVILLE-RICHTER Divaricatori per laminectomi	557
SAENGER Pinze per placenta e per ovaie	948	SCOVILLE-RICHTER Valve laterale	556
SALENIUS Bisturi per menisco	941	SCT Forbici da utero	565
Salpingografo	1146	SCT Forbici fine per chirurgia	186
SALYER Forbici per Face-lift	915	SCT Forbici nasali	190
SAMII Bisturi a lancetta	118	SCT Forbici per chirurgia	189, 190
SAMII Lama del tumore	837	SCT Forbici per dissezione	186, 187
SANTULLI Clamps Bulldog	836, 837	SCT Forbici per Face-lift	187
SANVENERO Forbici fine per chirurgia	296	SCT Forbici vascolari	190
SAROT Pinze per preparazioni e legature	124	SCUDDER Pinze stomaco	191
SAROT Portaghi	267	SEBILLEAU Elevatori	851
SAROT TC Portaghi	490	SEDILLOT Periostotomi	1074
SATINSKY Forbici vascolari	524	SEEMANN-SEIFERT Apribocca	1063, 1065
SATINSKY Pinze per vena cava	131	Seghe elettrica oscillante per autopsia	605
SATINSKY Pinze vascolari atraumatiche	347, 348	Seghe elettriche oscillanti per gesso	1022, 1023
SATTERLEE Seghe per amputazione e resezione	332	Seghe nasali	1196-1199
SAUERBRUCH Costotomi	1010	Seghe per amputazione e resezione	685
SAUERBRUCH Divaricatori	765	Seghe per aprire anelli	1009, 1010
SAUERBRUCH Pinze per rifiuti	382, 394	Seghe per gessi	1011
SAUERBRUCH Scatole per aghi	1218	SEGOND Bisturi per fibromi	1195
SAUERBRUCH-CORYLLOS Pinze per ossa	1223	SEGOND-LANDAU Pinze per isterectomia	56
SAUERBRUCH-FREY Costotomi	1140	SEIDL Speculi vaginali	273
SAUNDERS Strumento per la rimozione dell I.U.D.	767	SEIFFERT Pinze per Broncho-esofagoscopia	887
SAWTELL Pinze per tonsille	911	SELDIN Periostotomi	637
SCALP-CONTOUR Divaricatori, autostatici	620	SELLHEIM Leva ostetrica	1064
ScalPELLI	446	SELLORS Approssimatori costali	936
Scalpello per sterno	680-682, 751, 1025-1051	SELMANN Pinze da presa	800
Scatole per aghi	764	SELVERSTONE Pinze per laminectomia	204
Scatole per magazzino	1222, 1223	SEMB Cesoie per ossa	998, 999
Scatole per sterilizzare bendaggi	1225	SEMB Periostotomi	1144
Scatole per strumenti	1224	SEMB Pinze per bronchi	1066
SCHAEDEL Pinze fissatele	1216, 1217	SEMB Pinze per ossa	802
SCHAMBERG Tiracomedoni	368	SEMB Tenaglie per ossa	1139
SCHAEDE Curette per ossa	61	SEMKEN Pinze anatomiche per dissezione	1119
SCHAEIBE Pinze da presa per intestino e tessuti	1095	SEMKEN Pinze per chirurgia	199, 200
SCHHEINMANN Pinze per Broncho-esofagoscopia	362	SEMKEN TC Pinze anatomiche per dissezione	208, 212
SCHERBACK Speculi vaginali	637	SEMKEN TC Pinze per chirurgia	232
SCHIMMELBUSCH Scatole per sterilizzare bendaggi	894	SEMM Divaricatori addominali	234, 235
SCHINDLER Pinze per peritoneo	1224	SEMM Speculi vaginali	474
SCHINK Dermotomi	279	SENN-GREEN Divaricatori	882
SCHINK Placca per stendere la pelle	59	SENNING TC Portaghi	438
SCHIOETZ Tonometro	59	SENN-MILLER Divaricatori	523
SCHLESINGER Pinze per laminectomia	23	Separatore per il dente del giudizio	439
SCHMEDEN Pinze nasali	1006	Separatore per il corpo mandibulare	387
SCHMID Cannula per irrigazione vascolare	992	Separatore per ramo	1057
SCHMID Spatola per intima	73	Separatori mandibulari	386
SCHMIEDEN Aghi per legatura	813	Separatori per guancia	1057
SCHMIEDEN Sonda conduttrici	502	Separatori per labbra e guancia	619
SCHMIEDEN-DICK Aghi per legatura	511	Separatori per vertebre	618
SCHMIEDEN-PAYR Sonda conduttrici	501	Separatori per le radici dei nervi	592, 593
SCHMIEDEN-TAYLOR Forbici vascolari	511	Separatore per il borde anteriore	551-553
SCHNEIDER Periostotomi	133	Serranodi auricolari	1057

Serranodi per laringologia	738	Spatole addominali e intestinali	813, 814
Serranodi per polipi	652	Spatole cerebrali	421
Serranodi per tonsille	671	Spatole per impiastro	543, 544
Serrapene	623, 624, 627	Spatole per lingua	66
Serrapinze	946	Spatole per pulmone	600
Serrapinze e portapinze	845	Spatole vescicali	800, 801
Set di sonde per varici	860	Spazzola per unghie	953
Set per autopsia	806, 807	Spazzole per pulire	1227
Set per diagnostica	1021	Specchi laringei	1227
Set per tunnelare	30-35	Specchi per rinoscopia	632
SEUTIN Forbici per bendaggi e gessi	811	Specchio frontale	632
SEWALL Periostotomi	1191	Speculi auricolari	35
SEWALL Periostotomi	1052	Speculi nasali	720-726
SEXTON Aghi per paracentesi	1060	Speculi per chirurgia lombo vertebrale	660-668
SEYFFERT Speculi vaginali	735	Speculi per ipofisectomia	585
Sfigmomanometri	882	Speculi rettali	702
Sfinteroscopi	24-25	Speculi vaginali	861, 862
Sgorbia	863	SPENCER-WELLS Pinze emostatiche	880-895
Sgorbie per tessuto osseo spugnoso	751, 679, 1025-1051	Spezzacrani	242
Sgorbie spinali	1045	SPRATT Curette per ossa	937
SHAAF Pinze per ciglia	1050	SPREADY Divaricatori per laminectomi	1097
SHAMBAUGH Microuncini	223	SPURLING Pinze per laminectomia	589-591
SHAMBOUGH Adenotomi	749	Sputacchiera	997
SHAPLEIGH Anse auricolari	630	ST. CLAIR-THOMSON Coltelli per vegetazioni adenoidee	1214
SHEA Cucchia taglienti	729	ST. MARKS Dilatatori per l'ano ed il retto	629
SHEEHAN Osteotomi	751	ST. MARKS Divaricatori	866
SIEGLE Lenti auricolari	682	STACKE Sonde buttonute	420
SILVER Dermotomi	726	STANDARD Trequarti	62
SILVER Osteotomi	59	STAUDE-MOORE Pinze per abbassare il collo dell'utero	69
SIMON Bisturi per fistole	683	STEINBACH Martelli	901
SIMON Curette per ossa	56	STELLA TC Forbici per Face-lift	1018
SIMON Divaricatori	1100	STELLBRINK Pinze per ossa	175
SIMPLEX Separatori per guancia	415, 436	STELZNER Forbice per dissezione rettale	1127
SIMPSON Pinza obsterica	619	STERNBERG Separatori per labbra e guancia	107
SIMPSON-LUIKART Pinza obsterica	932, 933	Stetoscopi	618
SIMS Curette uterine	934	Stetoscopi fetali	17-19
SIMS Depressori uterini	900, 927, 930	STEVENS Forbici fine per chirurgia	17
SIMS Dilatatori per l'ano ed il retto	900	STEVENS Pinze per iridectomia	127, 156
SIMS Forbici da uteroa	861	STEVENS SCT Forbici fine per chirurgia	197, 208
SIMS Isterometri	98, 99, 151	STIEGLITZ Pinze per scheggio	191
SIMS SCT Forbici da uteroa	899	Stilette per canale lacrimale	1208
SIMS Speculi rettali	186	STILLE Forbici per gessi	62, 63
SIMS Speculi vaginali	862	STILLE Osteotomi	1192
SIMS TC Forbici da uteroa	887	STILLE Pinze anatomiche per dissezione	1032
SIMS-BODENHAMMER Dilatatori per l'ano ed il retto	163, 164	STILLE Pinze per calcoli biliari	197
SIMS-MAIER Pinze per medicazione	861	STILLE Pinze per chirurgia	878
SIMS-SIEBOLD Forbici da uteroa	355	STILLE Pinze per ossa	207
SINGLEY-TUTTLE Pinze per afferrare tessuti	100, 152	STILLE Pinze per peduncoli renali	1136
Sinuscopi	204	STILLE Scalpelli	283, 285
Siringa per laringei	599, 712	STILLE Sgorbie	1032
Siringhe	76	STILLE Trapani a mano per ossa	1033
Siringhe auricolari	74-76	STILLE-BARRAYA Pinza vascolare e per tumori	1171
Siringhe per aria	719	STILLE-RUSKIN Pinze per ossa	216
Sistema braccio	75	STILLE-SHERMAN Trapani a mano per ossa	1138
Sistema distrattore per il corpo vertebrale cervicale	478, 479	STOCKMANN Pinze per fissare	1171
SKENE Pinze per abbassare il collo dell'utero	560, 561	STOCKMANN Serrapene	946
SLUDER-BALLENGER Tonsillotomi	903	STONE Pinze per chirurgia	946
SMELLIE Spezzacrani	625	STONE-WATT Pinze per intestino e stomaco	218
SMELLIE Unico per detroncazione	937	STONE-WATT Serrapinze e portapinze	860
SMILLIE Bisturi per menisco	937	STRABISMUS Forbici per dissezione	860
SMILLIE Retrattori per ginocchio	1147	STRANDELL-STILLE Divaricatori	112
SMITH Forbici per bendaggi	1148	STRASSBURG Pinze per chirurgia	441
SMITH TC Forbici taglia cavo	1186	STRATTE Portaghi	212
SMITH-BUIE Dilatatori per l'ano ed il retto	180	STRATTE TC Portaghi	492
SMITH-PETERSEN Osteotomi	864	STRAUSS Serrapene	526
SMITH-PETERSEN Pinze per ossa	1039	Stripper anello	946
SMITH-PETERSEN Sgorbie	1134	STRONG (COBRA) Pinze vascolari atraumatiche	808
SMITHWICK Uncini per dura-madre	1040	STRUCK Divaricatori costali	318
SNELLEN Anse auricolari	554	STRUEMPEL Pinze auricolari	782
SOMER Pinze per afferrare l'utero	728	STRULLY Forbici vascolari	734
Sond doppia	909	Strumentario per corpi estranei	131
Sonda bottonuta	827	Strumentario per microchirurgia	731
Sonda con indicatore	827, 828	Strumenti curvi	745-753
Sonda per gozzo	748	Strumenti per aspirazione e irrigazione	1170
Sonde	657	Strumenti per cerchiaggio	86-89
Sonde a foglia di mirto	62-64	Strumenti per chirurgia a cuore aperto	1158
Sonde auricolari	62	Strumenti per circoncisione	824
Sonde buttonute	716	Strumenti per esaminare e misurare	956
Sonde conduttrici	62	Strumenti per introdurre cateteri	20-22
Sonde per calcoli biliari	509-513	Strumenti per mettere i punti	947
Sonde rettali	872, 873	Strumenti per microchirurgia	546, 547
Sonde scanalate	866	Strumenti per miniinvasiva chirurgia	827-841
Spatola per intima	63	Strumenti per ORL	818-823



Strumenti per sinusopia	495-761	TOENNIS-ADSON SCT Forbici per dissezione	115
Strumenti per varici	703-708	TOENNIS-ADSON TC Forbici per dissezione	189
Strumento per la rimozione dell I.U.D.	815	TOHOKU Pinze fissatele	173
STRUYKEN Pinze nasali	911	Tonometro	369
SUBRAMANIAN Pinze vascolari atraumatiche	990	Tonsillotomi	23
Succhielli per fibroma	299	Torchio per cartilagine	625
Supporto per gli apribocca	908	TOWNLEY Calibro	686
Supporto per sterilizzazione e conservazione	617	TOYNBEE Specoli auricolari	22
Supporto per strumenti Rhodon	1225	Transformatore	725
Supporto petto	839	Trapani a mano per ossa	27, 42, 43
Supporto porta-agrafe	638	Trapano per seno mascellare	1171-1173
Supporto sternale per tutti gli apribocca	546	TRAUBE Martelli percussori	693
Supporto valve atriali	617	TRAUTMANN Scalpelli	17
SWEDISH Dissettori per la dura-madre	820	TRAUTMANN Sgorbie	1029
SWEET Pinze per applicare le agrafe	550	TRAVERS Divaricatori, autostatici	1029
SYPERT Pinze per laminectomia	547	Trefine cutanee	456
SYPERT Pinze per laminectomia	985	TRELAT Periostotomi	60, 61
SYPERT Pinze per ossa	987	TRELAT Speculi vaginali	1053
SYSTRUNK Forbici per unghie	1140	Trequarti	882
T	1204	Trequarti per empiema	69-71
TABB Bisturi per mucosa		Trequarti per puntura del seno mascellare	70
Taglia cranio	745	Trequarti per sinusopia	69, 70, 87
TAKAHASHI Pinze nasali	1021	Trequarti per vescia biliare	692
TAKAHASHI Pinze per laminectomia	757	Trequarto per tracheotomia	71
Tamburo rumoroso	994	TREVES Pinze per chirurgia	653
TARNIER Cranioclasto	716	TROELTSCH Pinze auricolari e nasali	216
TARNIER Pinza obsterica	938	TROELTSCH-JALASVIRTA Pinze auricolari e nasali	221
TAYLOR Martelli percussori	935	TROEMMER Martelli percussori	221
TAYLOR Pinze anatomiche per dissezione	16	Tronchesini per unghie	16
TAYLOR Pinze per chirurgia	200, 201	TROUSSEAU Dilatatori per tracheotomia	1205, 1206
TAYLOR Retrattori per ginocchio	212, 213	TROUTMAN-CHRIS Pinze per afferrare	654
TAYLOR Valve laterale	1148	TROUTMAN-CHRIS Pinze per rompere le lamette de rasoio	47
TAYLOR-BROWN Pinze per chirurgia	558	TUBBS Dilatatori per aorta	47
TC Forbici da uteroa	216	Tubi aspirazione	810
TC Forbici fine per chirurgia	163, 164	Tubo di intubazione	77-89
TC Forbici nasali	177, 178	Tubo per aspirazione coagulazione,	653
TC Forbici per chirurgia	174	TUEBINGEN Divaricatori	87
TC Forbici per dissezione	162, 165, 167	TUEBINGEN Divaricatori, autostatici	414
TC Forbici per episiotomia	167-173	TUEBINGEN Micro-forbici	449
TC Forbici per Face-lift	162	TUEBINGEN Micro-pinze	140
TC Forbici per gengiva	175, 176	TUEBINGEN Pinze per calcoli biliari	227
TC Forbici per ginecologia	177, 178	TUFFIER Divaricatori	878
TC Forbici per isterectomia	162	TUFFIER Divaricatori costali	403
TC Forbici per legature	166	TUFFIER Pinze da presa per intestino e tessuti	780
TC Forbici per perineo	181	TURNBULL Tronchesini per unghie	365
TC Forbici per tonsille	162	TYDING Serranodi per tonsille	1205
TC Forbici taglia cavo	174	TYDING-TIVNEN Pinze per tonsille	624
TC Forbici vascolari	180	U	621
TC Pinze per sutura	179, 180	UCKERMANN Portacotone	
TEALE Pinze per abbassare il collo dell'utero	236	UCKERMANN Trequarto per tracheotomia	65
Telaio per sterilizzare aghi per sutura	904	UFFENORDE Curette per ossa	653
Tenaglie per ossa	1223	ULM Baule di emergenza	1114
Tenaglie per ossa	1117-1125	ULRICH Bisturi per fistole	28
Tenaglie tagliafilii	1126	ULRICH Pinze per tamponi	56
TERRIER Pinze emostatiche	1164-1170	ULRICH Tenaglie per ossa	349
TESSIER Forbici nasali	259	Uncini	1122
TESSIER Osteotomi	120	Uncini auricolari	706, 708, 747, 748, 750, 752, 753, 831, 832, 841
TESSIER Periostotomi	1033, 1036, 1037	Uncini per dura-madre	730, 731
TESSIER Pinza per formare osso	1058	Uncini tracheali	554, 555
THILENIUS Pinze per accessi tonsillari	1118	Uncino delicato	655
THOMS-ALLIS Pinze da presa per intestino e tessuti	623	Uncino nasale ad anello	830
THOMS-GAYLOR Pinze per la biopsia cervicale e da prelievo	364	Uncino per ali nasali	689
THOMSON-WALKER Divaricatori vescicali	919	Uncino per seno mascellare	688, 689
THOREK Forbici per dissezione	952	Uncino per staffa	747
THOREK TC Forbici per dissezione	113	Unici per esplorazione e coagulazione	747
THUDICHUM Speculi nasali	171	Uncini pere nervi e vasi	834
TIECK-HALLE Speculi nasali	660	Unico per detroncazione	822, 829
TILLEY Pinze per tamponi e polipi nasali	660, 661	UNIVERSAL Forbici per bendaggi e gessi	937
TILLEY-HENCKEL Pinze nasali	669	UNIVERSAL Forbici taglia cavo	1191
Tiracomedoni	989	UNIVERSAL Pinze per strumenti sterilizzati	148
TISCHLER Pinze per la biopsia cervicale e da prelievo	61	UNIVERSAL TC Forbici taglia cavo	1209
TISCHLER-KEVORKIAN Pinze per la biopsia cervicale e da prelievo	917, 921	UNIVERSAL Trequarti	180
TISCHLER-MORGAN Pinze per la biopsia cervicale e da prelievo	921	UNNA Tiracomedoni	69
TOBOLD Abassalingua	921, 922	UNNA-VIDAL Tiracomedoni	61
TOBOLD Pinze per polipi laringei	601	Uretrotomo	61
TOENNIS Coltello per dura-madre	634	Urinale	954
TOENNIS Forbici per dissezione	57, 58	USA Apri gesso	1216
TOENNIS Pinze emostatiche	114	USA Curette per ossa	1194
TOENNIS Portaghi	243, 255	USA Forbici ombelicali	1108, 1109
TOENNIS Spatola per intima	497	USA Pinze anatomiche per dissezione	102
TOENNIS TC Portaghi	814	USA Pinze per chirurgia	196
TOENNIS Uncini per dura-madre	531	V	206
TOENNIS-ADSON Forbici per dissezione	555	VALLEIX Isterometri	

Valve atriali	899	WERTHEIM Pinze per anastomosi del retto	100
VAN BUREN Candelette dilatatrici	820	WERTHEIM Pinze per isterectomia	859
VAN BUREN Pinze per frammento osseo	950	WERTHEIM TC Forbici per isterectomia	271, 272
VAN DOREN Pinze per la biopsia cervicale e da prelievo	1118	WERTHEIM-CULLEN Pinze per isterectomia	166
VANNAS Micro-forbici	918, 919	WEST Scalpelli	276
VARADY Flebo-dissettori	140	WEST Sgorbie	1025
VARADY Flebo-estrattore	814	WESTCOTT Micro-forbici	1025
VARADY Micro-dissettori	814	WESTMACOTT Pinze per tamponi e polipi nasali	141
VARADY Set di sonde per varici	814	WHITE Pinze per tonsille	669
VASCULAR Portaghi	807	WHITEHEAD Apribocca	620
VEDDER Serranodi per tonsille	498	WIEDER Abassalingua	604
VEIDENHEIMER Pinze per anastomosi del retto	624	WIEN Speculi nasali	602
Vena-compresión	857	WIEN MOD. Pinze per isterectomia	662
VERBRUGGE Tenaglie per ossa	29	WIEN Trapano per seno mascellare	274
VERHOEVEN Tubi aspirazione	1124	WIGMORE Coltelli per gessi	693
VERRES Cannula per insufflazione	89	WIKSTROEM Pinze per preparazioni e legature	1195
VICKERS Dissettori	73	WILDER Stilette per canale lacrimale	269
VICKERS Divaricatore per dita	1052	WILLET Pinza per il cuoio cappelluto	63
VICKERS Divaricatori	1183	WILLET-MARTEL Pinze da presa per intestino e tessuti	936
VICKERS Elevatori	428, 1183	WILLIAMS Divaricatori, autostatici	366
VICKERS Fissatore per mano	1052	WILLIAMS Pinze da presa per intestino e tessuti	464
VICKERS Perforatori a mano	1182	WILLIGER Curette per ossa	360
VIDAL Raschiatoio per lupus	1156	WILLIGER Divaricatori	1094, 1096
VIENNA Portalegature	60	WILLIGER Elevatori	420
Vigorimeter	513	WILLIGER Martelli	1074
VIRCHOW Coltelli per autopsie	21	WILLIGER Periostotomi	1016
VIRCHOW Coltelli per cervello	54	WILMER-WALTER Forbici nasali	1053
VIRCHOW Taglia cranio	55	WILSON Pinze per abbassare il collo dell'utero	122
VOLKMANN Curette per ossa	1021	WINTER Pinze per placenta e per ovaie	904
VOLKMANN Divaricatori	1092, 1096, 1104, 1105	WIS-FOREGGER Laringoscopi	939, 940
VOLLMAR Cannula per irrigazione vascolare	374, 378	WITTNER Pinze per la biopsia cervicale e da prelievo	39
VOLLMAR Stripper anello	73	WOLFF Apri gesso	920
VOLTOLINI Speculi nasali	808	WOLFF Curette per lupus	1194
W	660	WOODSON Dissettori per la dura-madre	60
WACHENFELDT Pinze per applicare le agrafe		WRIGLEY Pinza obsterica	812
WAGENER Divaricatori	517	WUERZBURG Abassalingua	935
WAGNER Forbici fine per chirurgia	429	WULLSTEIN Divaricatori, autostatici	616
WAGNER Leve per ossa	125, 126	WULLSTEIN Manico per aspirazione	447
WAGNER Martelli	1076, 1080, 1081	WULLSTEIN Micropinze con morsi a cucchiaino	85
WAGNER Periostotomi	1014	WULLSTEIN Periostotomi	739
WAGNER Pinze per laminectomia	1070	WULLSTEIN Tubi aspirazione	1054
WAGNER Sgorbie	985, 986	Y	77, 86
WAGNER Strumenti curvi	1049	YANKAUER Tubi aspirazione	
WAGNER TC Forbici fine per chirurgia	1170	YASARGIL Bisturi per vasi	81, 82
WALB Coltelli per autopsia	177	YASARGIL Dissettori	838
WALDMANN Forbici per episiotomia	55	YASARGIL Ganci galea	835
WALDMANN Forbici per perineo	101, 152	YASARGIL Guida per legatura	545
WALDMANN TC Forbici per episiotomia	101, 152	YASARGIL Periostotomo	829
WALDMANN TC Forbici per perineo	162	YASARGIL Pinze per laminectomia	835
WALLICH Cucchiaini uterine	162	YASARGIL Tubi aspirazione	1005
WALTER Osteotomi	911	YASARGIL-NICOLA Micropinze da presa	80
WALTER Scalpelli	682	YEOMANN Pinze per biopsia rettale	651
WALTER Sgorbie	682	YOUNG Pinze da presa per lingua	869
WALTER Uncino per ali nasali	1033	YOUNG Retrattori prostatici	618
WALTON Pinze per biopsia rettale	688	YOUNG-HRYNTSCHAK Aghi per legatura	953
WALTON Seghe per aprire anelli	869	Z	513
WALTON-YANKAUER Tubi aspirazione	1011	ZANDER Puteruoli	
WANGENSTEEN Pinze per afferrare tessuti	81	ZAUFAL Leva auricolare	1012
WANGENSTEEN Portaghi	204	ZAUFAL-JANSEN Pinze per ossa	730
WANGENSTEEN TC Pinze anatomiche per dissezione	494	ZAUFAL-JANSEN Uncini auricolari	1133
WANGENSTEEN TC Portaghi	233	ZENKER Divaricatori	731
WARTENBERG Algesiometro	527	ZENKER Pinze per preparazioni e legature	391
WARTENBERG Rotella neurologica	20	ZIEGLER Coltello per dura-madre	262, 263
WASSMUND Divaricatori	20	ZIEGLER Pinze per ciglia	57
WATSON Dermotomi	380	ZIEGLER Specchio frontale	223
WATSON-CHEYNE Dissettori	59	ZIELKE Sgorbie	35
WATSON-JONES Leve per ossa	1056	ZOELLNER Bisturi falciforme	1044
WATSON-WILLIAMS Pinze nasali	1076	ZOELLNER Bisturi lanceolato	752
WAUGH Pinze per chirurgia	993, 994	ZOELLNER Bisturi rotondi	752
WEBER Estesometro	206	ZOELLNER Forcella di guida	752
WEBER Pinze vascolari atraumatiche	20	ZOELLNER Microaghi	752
WEBER-LOCH Anse auricolari	312	ZOELLNER Periostotomo	752
WEBSTER Portaghi	729, 730	ZOELLNER Specchi auricolari	752
WEBSTER TC Portaghi	491	ZOELLNER Tubi aspirazione	720
WECKER Micro-forbici	525	ZOELLNER Uncino	89
WEIL-BLAKESLEY Pinze nasali	139	Z-PARAMETRIUM Pinze per isterectomia	752
WEIL-BLAKESLEY Pinze per etmoide	988, 989		286
WEISMAN Curette auricolari	745		
WEISSBARTH Speculi vaginali	729		
WEITLANER Divaricatori, autostatici	895		
WEITLANER-BABY Divaricatori, autostatici	446, 447, 453, 454		
WELLER Pinze da presa per menisco e cartilagine	449		
WERTHEIM Forbici da utero	1145		



Milimeter | Milimeter | Milímetro | Milimetro

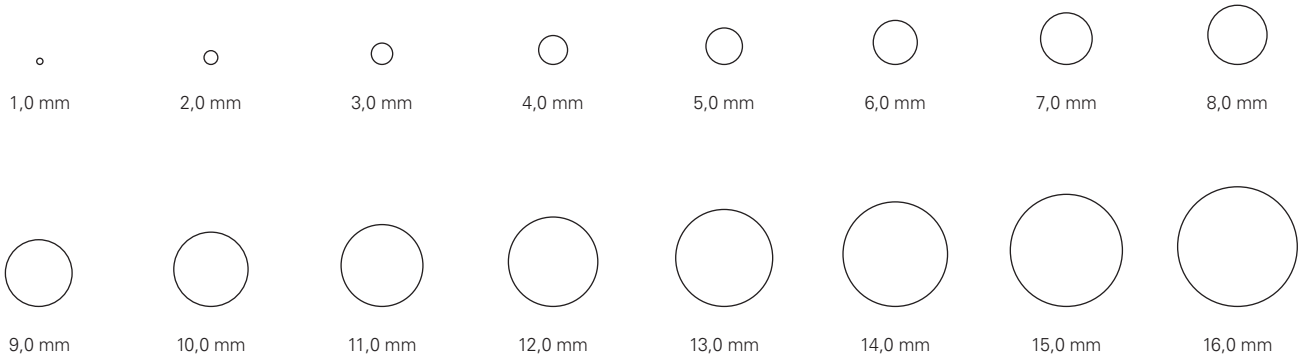

French | Charrière

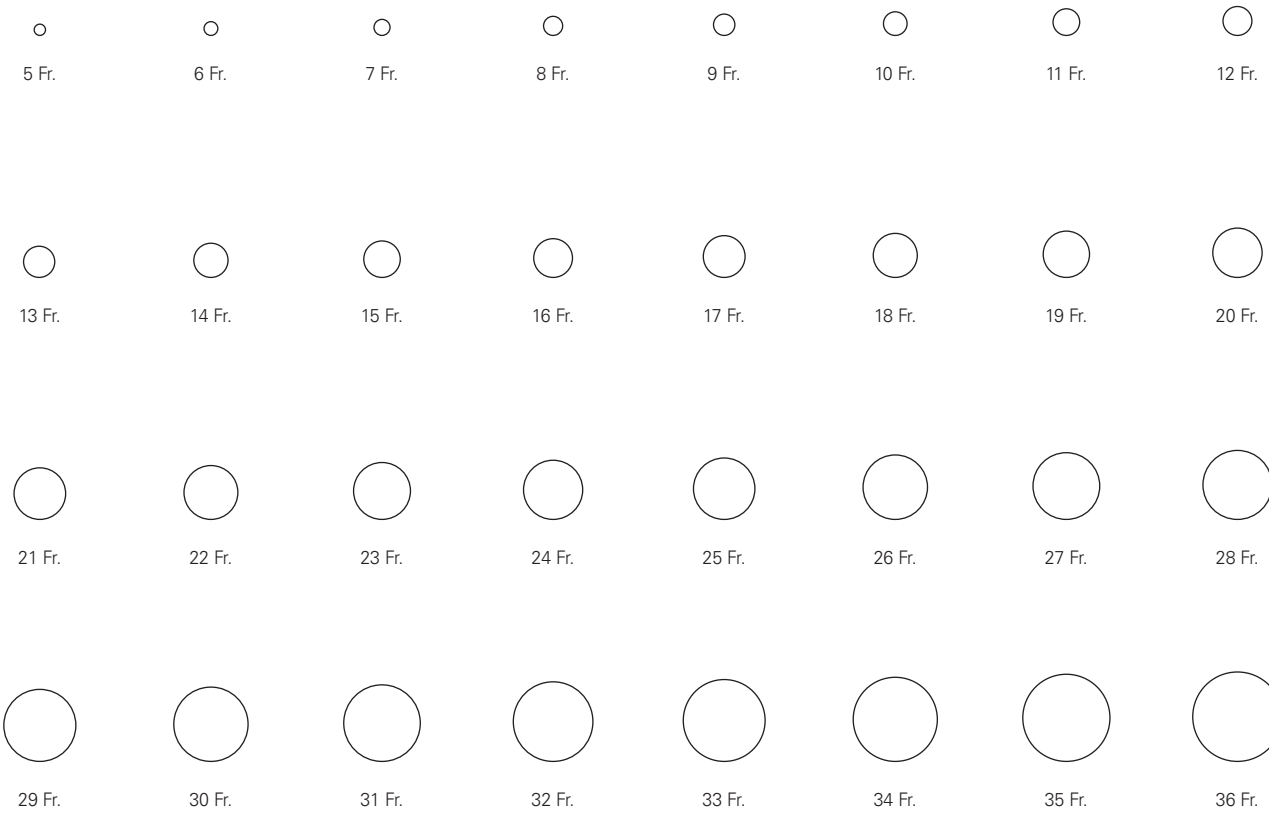

French | Charrière

5 Fr.	1,7 mm	21 Fr.	7,0 mm
6 Fr.	2,0 mm	22 Fr.	7,3 mm
7 Fr.	2,3 mm	23 Fr.	7,7 mm
8 Fr.	2,7 mm	24 Fr.	8,0 mm
9 Fr.	3,0 mm	25 Fr.	8,3 mm
10 Fr.	3,3 mm	26 Fr.	8,7 mm
11 Fr.	3,7 mm	27 Fr.	9,0 mm
12 Fr.	4,0 mm	28 Fr.	9,3 mm
13 Fr.	4,3 mm	29 Fr.	9,7 mm
14 Fr.	4,7 mm	30 Fr.	10,0 mm
15 Fr.	5,0 mm	31 Fr.	10,3 mm
16 Fr.	5,3 mm	32 Fr.	10,7 mm
17 Fr.	5,7 mm	33 Fr.	11,0 mm
18 Fr.	6,0 mm	34 Fr.	11,3 mm
19 Fr.	6,3 mm	35 Fr.	11,7 mm
20 Fr.	6,7 mm	36 Fr.	12,0 mm



cm



Zoll | Inch



Zoll | Inch

1"	25,4 mm
1 1/4"	31,7 mm
1 1/2"	38,1 mm
1 3/4"	44,5 mm
2"	50,8 mm
2 1/4"	57,1 mm
2 1/2"	63,5 mm
2 3/4"	69,8 mm
3"	76,2 mm
3 1/4"	82,5 mm
3 1/2"	88,9 mm
3 3/4"	95,2 mm
4"	101,6 mm
4 1/4"	107,9 mm
4 1/2"	114,3 mm
4 3/4"	120,6 mm
5"	127,0 mm
5 1/4"	133,3 mm
5 1/2"	139,7 mm
5 3/4"	146,0 mm
6"	152,4 mm
6 1/4"	158,7 mm
6 1/2"	165,1 mm
6 3/4"	171,4 mm
7"	177,8 mm
7 1/4"	184,1 mm
7 1/2"	190,5 mm
7 3/4"	196,8 mm
8"	203,2 mm
8 1/4"	209,5 mm
8 1/2"	215,9 mm
8 3/4"	222,2 mm
9"	228,6 mm
9 1/4"	234,9 mm
9 1/2"	241,3 mm
9 3/4"	247,6 mm
10"	254,0 mm
10 1/4"	260,3 mm
10 1/2"	266,7 mm
10 3/4"	273,0 mm
11"	279,4 mm
11 1/4"	285,7 mm
11 1/2"	292,1 mm
11 3/4"	298,4 mm
12"	304,8 mm
12 1/4"	311,2 mm
12 1/2"	317,5 mm
12 3/4"	323,9 mm



AMNOTEC

International Medical GmbH
take-off GewerbePark 9
78579 Neuhausen ob Eck · Germany

Web: www.AMNOTEC.de
Mail: info@AMNOTEC.de
Tel: +49 (0) 74 67 94 93 90-0

AMNOTEC - Leidenschaft für Endoskopie Lösungen AMNOTEC - Passion for Endoscopy Solutions



Der Begriff „Medizintechnik aus Tuttlingen“ steht für hochwertigste chirurgische und medizintechnische Instrumente sowie für Dynamik und Fortschritt auf dem Gebiet der Implantattechnologie und der minimalinvasiven Chirurgie.

AMNOTEC sieht sich als innovatives Unternehmen des 21. Jahrhunderts eng mit diesem branchenprägenden Qualitätsbegriff verbunden.

Die Amnotec GmbH verfügt gemeinsam über 25 Jahre Erfahrung in der Medizintechnik. Dieses Fachwissen, die Qualität der Produkte sowie Flexibilität und ein exzellenter Kundenservice sind die Eckpfeiler unseres Unternehmens und machen uns zu einem kompetenten Partner und Komplett-Anbieter für den OP.

The concept „Medical technology from Tuttlingen“ stands for surgical and medical-technology instruments of highest quality as well as for dynamic and progress in the field of the implant-technology and minimal invasive surgery.

As an innovative enterprise of the 21st century, AMNOTEC considers itself closely connected to this industry shaped quality concept.

The Amnotec GmbH has more than 25 years experience in the medical business. This specialized knowledge, the quality of the products as well as flexibility and an excellent customer service are the cornerstones of our company and make us to a competent partner and complete supplier for the OR.



AMNOTEC 
INTERNATIONAL MEDICAL